

Haier

Automatic Drum Washing Machine

HMS1002A

HMS1000TVE/ME



Table of Contents

Before using the appliance

Identification	inside front cover
Matters needing attention.....	1-3
Installation.....	4-5
Operational functions	6-7

How to operate the washing machine

Program description table.....	8
Preparation.....	9
Washing methods	10 -11
Other functions.....	12

Maintenance

Maintenance	13-14
Trouble shooting	15
Wiring circuit	16
Specifications	16

Name of Parts

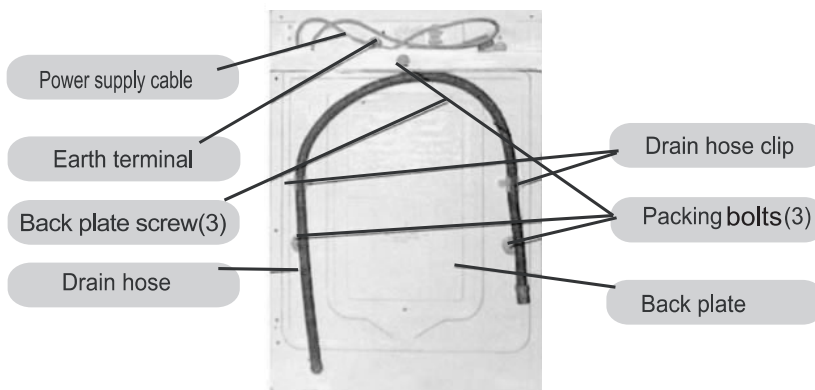
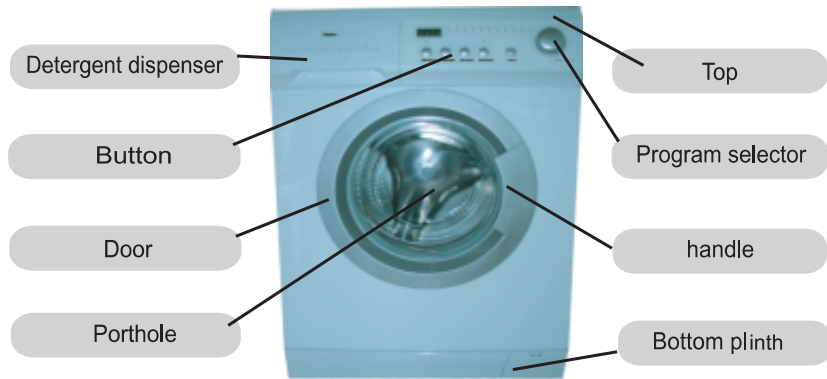

Caution and Warning symbols



For your safety, any instructions in this manual with this "Warning" sign must be followed strictly.



For your safety and to prevent damage to the washing machine, any instructions in this manual with this "Stop" sign must be followed strictly.

This diagram may be slightly different from the layout of the washing machine you have just purchased due to technical improvements

Matters Needing Attention

● Safety

1. A separate earthed socket is required for the power supply. The washing machine must be positioned so that the plug is accessible.

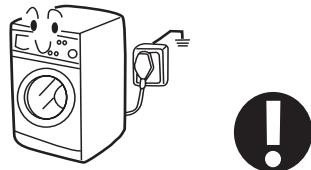

2. Hold the plug and not the electric cable when unplugging the washing machine.



3. Fuses in the power circuit should be rated for 15A. If the supply cord is damaged, it must be replaced by the manufacturer, its service agent or similarly qualified persons in order to avoid a hazard.

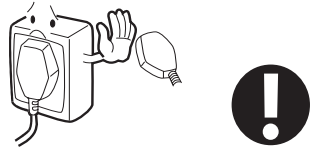

4. Do not touch or use the washing machine barefooted or when the hands or feet are wet.

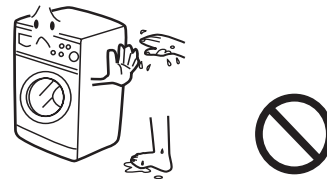

5. Do not use flammable detergent or dry cleaning agent; do not use flammable spray in close vicinity to the washing machine; do not remove or insert the plug in the presence of flammable gas.

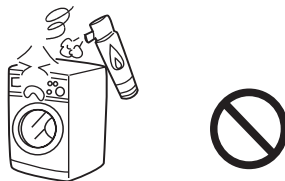

6. The door of the washing machine will become hot during the heating process. Avoid contact with the door during the heating process. For safety, keep children away from the washing machine.



7. Keep children away from the packing materials after unpacked.

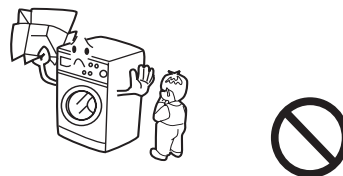

Matters Needing Attention

8. The washing machine should not be installed outdoors or in a damp place. In the event of water leakage or splashes allow the machine to dry naturally.



9. The carpet must not obstruct the ventilation openings in the base of the washing machine.



10. Keep away from heat sources and direct sunlight to prevent plastic and rubber components from aging.



11. During installation, ensure that the electric cable is not trapped by the washing machine and avoid damage to the electric cable.

Dear customer, For the machine and you own security, DO NOT REPAIR IT BY YOURSELF! DO NOT USE THE WASHING MACHINE WHICH SOME PARTS ARE LOST!



● During Use







1. Before use, check the joints of the filling hose, the tap and the drainage hose for possible problems from water pressure fluctuations. If joints are loose or there is leakage, turn off the tap and repair. Do not use the washing machine until the hoses are properly fixed.



2. Keep the door slightly open when the washing machine is not in use to prevent formation of odors; do not cover the washing machine with plastic cover so that inside dampness cannot be kept in.



Matters Needing Attention

<p>3. Do not place heavy, heating source or wet articles on the top of the washing machine.</p> 	<p>4. Do not hot wash foam rubber or sponge-like materials.</p> 
<p>5. Before washing, do up zippers, buttons and clothes straps and put small articles, such as socks, laces or bras, into a washing bag or a pillow.</p> 	<p>6. Do not open the detergent distribution drawer during the wash cycle.</p> 
<p>7. The door is fitted with a self-lock device and will not open until 2~3 minutes after the washing machine stops. Do not force the door open. Do not open the door if water level can reach the porthole.</p> 	<p>8. After each wash program, turn off the tap to prevent leakage; and unplug the washing machine and wipe clean the lower part of the porthole.</p> 

Installation

- Remove all the packing materials (including the foam base) to prevent vibration during use, as shown in Fig. 1.
Upon opening of the package, water drops may be seen on the plastic bag and the porthole. This is normal phenomenon resulting from water test in the factory

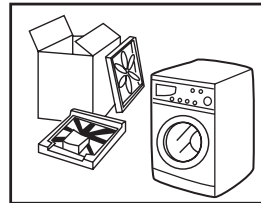

Fig.1

- Check attachments and materials with reference to the following

	Operation manual	Quality certificate	Water hose	Drainage holder	Plastic plugs
Quantity	1	1	1	1	3

- Dismantle the packing bolts as shown in Fig. 2. The packing bolts are designed for clamping anti-vibration components inside of the washing machine during the transportation process.

Before use:

1. Remove the back plate;
2. Remove the three packing bolts on the back plate and take out the rubber hose;
3. Replace the back plate;
4. Fill the holes left by the packing bolts with plastic plugs.

Attention: The packing bolts and rubber hose should be kept in a safe place for later use.

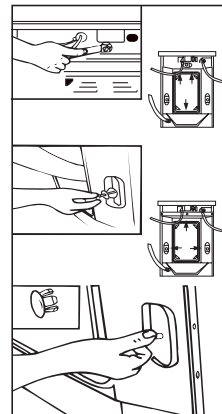

Fig.2

- Adjusting the washing machine
There are adjustable feet under the bottom of the washing machine. Before use, the washing machine should be adjusted, as shown in Fig. 3, so that it is level.

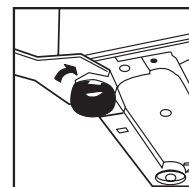
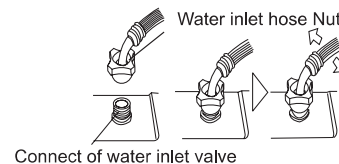

Fig 3

Installation

Joining the Inlet Hose to the Washing Machine

1. Connect the nut on the inlet hose to the connector on the water valve.
2. Tighten the nut to secure the hose.



Drainage Hose

- The height of the drainage outlet must be 80-100cm. To prevent the drainage hose from dropping off, fix it to the drainage hose clip at the back of the washing machine.
 - Use the drainage holder to keep the end of the drainage hose retained and to prevent the outflow of water. It is recommended that the length of the drainage hose not be increased; if an extension is needed, please consult a serviceman. The additional hose should be no more than 250cm (overextended hoses could lead to siphonage).
- Note: The drainage hose should not be submerged in water and should be securely fixed and leak-free. When the drainpipe is placed on the ground or the height of the pipe end is less than 80cm, the washing machine will drain while being filled.

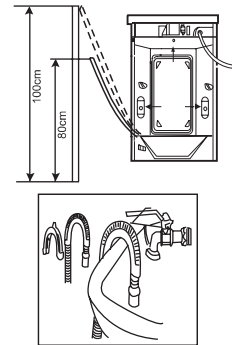

Connecting to the Power Supply

Before connecting to the power supply, check:

- The socket is adequate for the maximum power of the washing machine (For safety, fuses in the power circuit should be rated for no less than 15A).
- The voltage should meet the requirement.
- The power supply socket and the plug of the washing machine should be compatible. If they are not compatible, refer to a washing machine technician or a Haier designated service point for power cable replacement. The washing machine should be connected to the earth before use.
- Supplementary earth cable should not be necessary if the socket is connected to the earth.
- Supplementary earth cable should be installed on the upper back of the washing machine and connected to an earth if the power supply socket has no earth connection.

Operational Functions

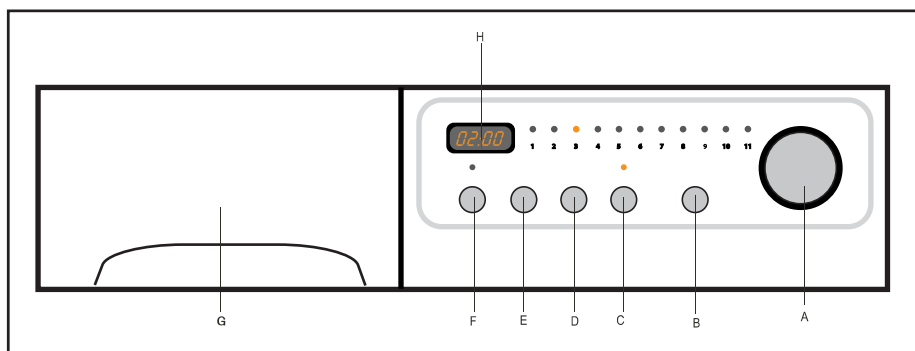

A: Wash programming knob

By turning the knob clockwise/counterclockwise, the required program can be selected. There are 11 programs available. After a program is selected, the corresponding light will go on.

B: Power Switch

Press this button to switch on the washing machine. Press it again to switch it off.

C: Start / Pause Button

When the washing machine is connected to the power socket and a program is selected, lightly touch this button to start operation. During a wash cycle, touch it lightly, operation will stop and the digits on the screen start blinking. Touch it again to resume operation. To cancel a wash program during a wash cycle, touch this button, when the digits on the screen start blinking, press the Power switch, the program will be cancelled.

D: Spinning Speed Setting Button

Touch this button lightly to select the desired speed. When a speed is set, it will be displayed on the screen.

Note: Different water temperatures and spinning speeds can be set for different laundries. Wash using the default settings if there is no special requirement.

E: Washing temperature button

Touch this button lightly, the washing temperature will be displayed on the screen. Select a temperature according to the type of laundry.

Operational functions

F: Delay Button

Touch this button lightly, the washing machine will start operation after a period of time and the corresponding indicator will go on. The range is 0.5-24 hours; each touch of this button increases a half hour. After the button is set, press the Start/Pause button to start countdown of the set time (the time is displayed on the screen until the program ends).

Note: The delay time must be longer than the program time; otherwise, the washing machine will start the wash program directly.

E+F: Combination for keyboard lock

(The key combination of E+F does not work until the Start/Pause key is pressed.)

Press these two keys simultaneously, the sign "LOCK" and the remaining washing time are displayed on the LED alternately. Now all the function keys except the Power switch can be locked. Press the key combination again to cancel this function.

G: Detergent distribution drawer

Open the drawer, three compartments can be seen:

Compartment 1: Prewash detergent

Compartment 2: Normal - Quick wash detergent

Compartment 3: Softener, conditioning agent, perfume, etc.

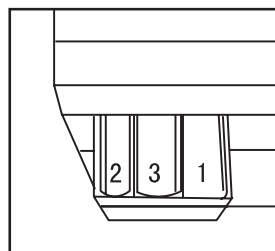

H: Display

Such information as remaining wash time, temperature and speed setting and error messages will be shown.

Note: After power is switched on, the display will go on and the remaining wash time decreases. As the water pressure and temperature may differ, the remaining time may be adjusted accordingly. When the laundry is not balanced during spinning, the time may be automatically prolonged. These are normal phenomena.

Program description table

Program	Recommended Laundry	Temperature	Detergent		
			1	2	3
Prewash	Heavy-soil laundry	Cold-30-40-60-80	★	★	○
Cotton	Cotton fabrics	Cold-30-40-60-80	×	★	○
Synthetic	Fast-color synthetic	Cold-30-40-60	×	★	○
Wool	Woolen fabrics	Cold-30-40	×	★	○
Cashmere	Cashmere fabrics	Cold-30-40	×	★	○
Silk	Silk fabrics	Cold-30-40	×	★	○
Quick	Medium-soil laundry	Cold-30-40	×	★	×
Wash	Medium-soil laundry	Cold-30-40-60	×	★	×
Rinse	Medium-soil laundry	/	×	×	○
Spin	/	/	×	×	×
Drain	/	/	×	×	×

Note: "○" indicates that softener can be added if needed;

"★" indicates that detergent must be added;

"X" indicates that detergent must not be added.

1) The wash temperature refers to the maximum temperature.

2) The wash cycle times are intended as a guide only. The actually used time may vary due to different water pressure, initial water temperature, etc.

Preparation

1. Power supply
 Plug in the power supply
 (220V-240V~/50Hz).

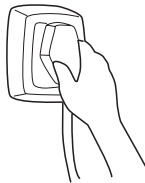

2. Water supply

Turn on the tap ensure that the water is clear.

Caution: Before starting the washing machine turn on the water faucet to ensure that the water faucet and the water inlet hose are connected correctly and do not leak.



3. Detergent selection
 Only special low foam detergent should be used in automatic drum washing machine, for blended or wool fabrics special detergent should be used. dry cleaning solvent should not be used such as trichloroethylene or alike (caution :load the required amount of detergent only).

4. Laundry treatment

- sort out clothes according to type and extent of dirt. There are three types of clothes: cotton, synthetic and woolen (silk) fabrics.
- separate white clothes from colored. If whites and coloreds are combined for one load, make sure the coloreds are colorfast.
- Remove all objects from pockets that may cause damage to the machine, such as keys and coins.

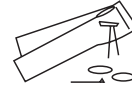

- Clothing with frayed edges or yarns should be put in a wash bag or special bag before washing.
- Repair damaged clothing, lose buttons or damaged zips and hooks before washing.
- Bed sheets and table ware should be loosely loaded and not folded.
- This washing machine is for household use and designed for mechanically washable clothes. When washing, separate unwashable clothes with reference to clothes labels.

5. Wash Load

Type	non-fade cottons	Delicat fabrics	Wool /Cashmere / Silk
Max load	5 kg	3 kg	2 kg

Washing methods

1. Loading

Open the door, put in the laundry piece by piece and then tightly close the door.

Notes:

1) When first using the washing machine, let it run unloaded for one program to prevent the laundry from being tainted by oil or dirty water from the washing machine.

2) Do not overload the washing machine.



Load Reference

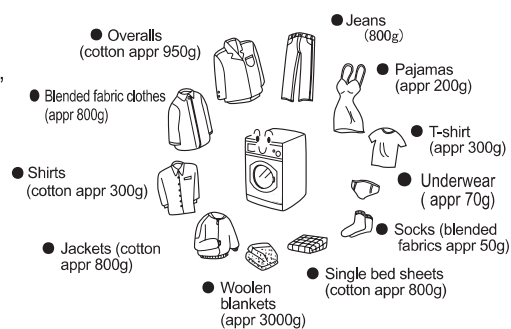

2. Adding detergent

Slide out the detergent drawer and put the required detergent and softening agent into the corresponding boxes. Push back the drawer gently.

Caution:

- 1) Do not add liquid detergent to compartment 1 and 2.
- 2) For prewashing program, detergent should be added to both compartments 1 and 2. For other programs, do not add detergent to compartment 1.
- 3) Do not overuse softener; otherwise, it will damage the artificial fibers.

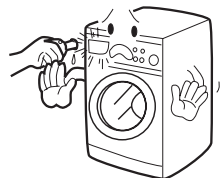

3. Selecting washing program

To get the best washing effect, an appropriate washing program should be selected according to the laundry type.

Washing methods

4. Setting washing temperature

Press the temperature button until " _ _ " is displayed if heating is not needed; otherwise, select an appropriate temperature as required .

5. Function selecting button

Select functions as required (refer to the "Operational Functions" section).

6. Washing

Press the Start / Pause button, the washing machine starts operation.

7. Finish

The washing machine will stop operation automatically when a wash cycle ends. The "End" sign will appear. Open the door and take out the laundry. Then turn off the tap and unplug the power cable.

Hints for saving energy

● During operation

1. Collect clothes for one full wash load.
2. Do not overload the washing machine.
3. Prewash heavily soiled clothes.
4. Reduce the amount of detergent or choose standard or delicate wash programs for slightly soiled clothes.
5. Choose a proper washing temperature. Only exceed 60°C for heavily soiled clothes.
6. Do not use more detergent than required.
7. Conditioner makes clothes feel softer and easier to iron.

Other Functions

1. Control panel lock function:

To prevent children from accidentally changing the settings, the control panel can be locked by pressing the "Temperature" and "Extra rinse" buttons at the same time. After the panel is locked, the sign "LOCK" and the wash time are displayed alternately and all the keys except the Power switch are inactivated. Press the two buttons again to cancel.

2. Power-off memory function:

This machine has a power-off memory function. In case of abrupt power failure or the power must be cut off during a program cycle, the present settings will be saved, and operation will resume when the power is switched on again.

3. Display messages:

- Err1** Cause: Door is not properly shut.
Correction: Shut the door properly.
- Err2** Cause: Drainage error, water not emptied within 4 minutes.
Correction: Clean the filter and check the drain hose for blockage. If error still exists, please contact the maintenance personnel.
- Err3** Cause: Temperature sensor not properly connected or damaged.
Correction: Contact the maintenance personnel.
- Err4** Cause: Heating coil damage or overload of laundry that leads to a failure to reach the set temperature within the specified time (This message is displayed at the end of a program).
Correction: Reduce load and then start washing again or contact the maintenance personnel.
- Err5** Cause: Water level not met in 8 minutes.
Correction: Make sure that tap is turned on, and water pressure is normal. If problem still exists, please contact the maintenance personnel.
- Err7** Cause: Motor overheat protection or damage.
Correction: Contact the maintenance personnel.
- Err8** Cause: Water exceeds protective level.
Correction: Contact the maintenance personnel.
- End** A program ends.
- 1:25** The remaining time is 1 hour 25 minutes.

Maintenance

1. Turn off the water tap and pull out electricity plug after each wash. Open the porthole to prevent formation of moisture and odors. If the washing machine is left idle for a long period, drain the water in the machine and replace the drainage hose.

2. Unplug the machine during cleaning and maintenance. Use a soft cloth dampened with soap liquid to clean the machine case and rubber components. Do not use organic chemicals or corrosive solvents.

3. Clean the detergent distribution drawer regularly. Raise the drawer slightly and pull it out, flush it clean with water and then replace it.

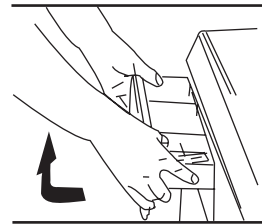

4. Clean the filter Cleaning methods (once a month)

- 1) Push out the outer cover (Fig. 1);
- 2) Screw out filter by turning counterclockwise (Fig. 2);
- 3) Flash clean with running water;
- 4) Replace the filter by turning clockwise and remount the cover.

Caution: Turn the filter clockwise until it is in the place after the drain pump is cleaned.

The filter must be in place, or it may lead to leakage.

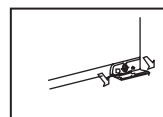

Fig,1

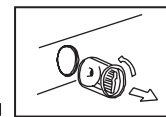

Fig,2

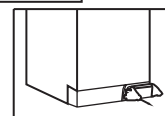

Fig,3

Maintenance

5. To prevent blockage to the water supply by ingress of foreign substances, clean the water inlet and inlet filter regularly.

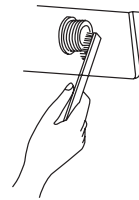

6. If the machine is to be moved to a distant place, replace the vibration absorbing locks (packing screws, rubber gaskets) removed before installation to prevent damage as shown below.

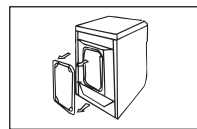

Remove the back cover and take out the three rubber plugs.

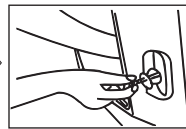

Insert the channel steel vibration locks and the bolts.

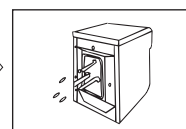

Insert the rubber bolt gaskets.

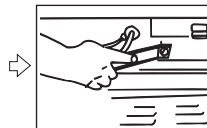

Tighten the bolts with a spanner.

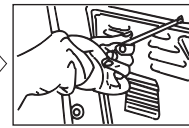

Replace the back cover.

7. If the washing machine is left idle for a long period, pull out the electrical plug and turn off the water tap. Open the door to prevent formation of moisture and odors. Let the door open while not used.

Trouble shooting

The following circumstances do not constitute problems. Do not contact the maintenance service until the problem has been confirmed.	
Problem	Possible Cause
The washing machine fails to operate	<ul style="list-style-type: none"> ● Poor connection to power supply ● Power failure ● Door is not properly closed ● Machine has not been switched on
Washing machine does not fill with water	<ul style="list-style-type: none"> ● Water tap is not turned on ● Water pressure is less than 0.03MPa ● The inlet hose is kinked ● Water supply failure ● The program knob is not properly set ● The door is not properly closed
The water supply and drainage do not stop	<ul style="list-style-type: none"> ● Check that the height of the water hose is below 80cm
Drainage failure	<ul style="list-style-type: none"> ● Drainage hose is blocked ● Drainage hose end is exceed 100cm above the floor level
Strong vibration during spinning	<ul style="list-style-type: none"> ● Some packing fixing bolts not removed ● Washing machine on a uneven surface
Operation stops before completion of the wash cycle	<ul style="list-style-type: none"> ● Water or electricity failure
Excessive foam in the drum	<ul style="list-style-type: none"> ● The detergent is not a low foam type ● Excessive detergent has been used

Wiring Circuit

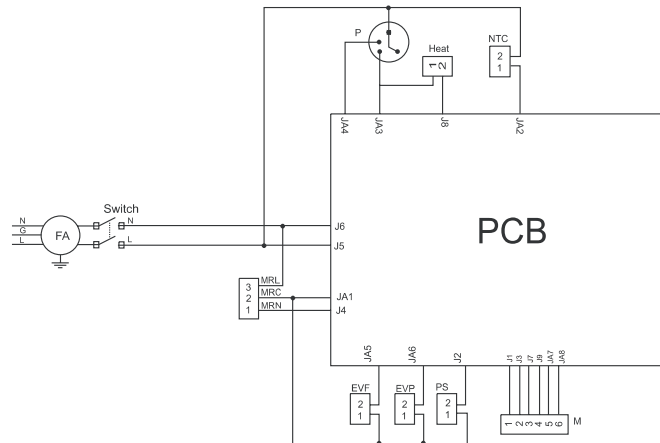

- PCB-Printed Circuit Board
- FA-Interference Suppressor
- Switch-Power Switch
- P-Pressure Switch
- Heat-Heating element
- NTC-Temperature Sensor
- MR-Door Lock
- EVP,EVF-Water Inlet Magnetic Valve
- PS-Drainage Pump
- M-Motor

Specifications

Item / Model	HMS1000TVE/ME	HMS1002A
Power supply	220V-240V~/50Hz	220V-240V~/50Hz
Maximum working current(A)	10	10
Water pressure (MPa)	$0.03 \leq P \leq 1$	$0.03 \leq P \leq 1$
Max power(W)	1850	2100
Max. wash load (kg)	5	5
Spinning speed (MAX) (r/min)	1000	1000
Wash program	11	11
Dimensions (H×D×W mm)	850×535×595	850×535×595
Weight (kg)	64	65

Free Manuals Download Website

<http://myh66.com>

<http://usermanuals.us>

<http://www.somanuals.com>

<http://www.4manuals.cc>

<http://www.manual-lib.com>

<http://www.404manual.com>

<http://www.luxmanual.com>

<http://aubethermostatmanual.com>

Golf course search by state

<http://golfingnear.com>

Email search by domain

<http://emailbydomain.com>

Auto manuals search

<http://auto.somanuals.com>

TV manuals search

<http://tv.somanuals.com>