

Haier

FRONT LOAD WASHING MACHINE

Service Manual



Suited model:

**HW-C1260TVE-U
HW-C1260TVEME-U
HW-C1460TVE-U
HW-C1460TVEME-U**

Features:

- **300mm diameter porthole, door may be open at a 180 degrees.**
- **Class-A energy-saving; Homocentric tubs with higher energy efficiency**
- **Multi-gear speed controller**
- **Unique gasket design featuring no residual water hidden inside**
- **Delay time adjustable**
- **Large wash load capacity 6kg**

Serial Number: SM HW-C1260/1460TVE/ME-U-01

Version:00.01 Edition: 2007-01-24

1、 Contents	1
2、 Features	2
3、 Sale points	2
4、 Specification	3
5、 Safety	5
6、 Installation	7
7、 Net dimension	10
8、 Names of the parts	11
9、 Operational Functions	12
10、 Trouble shooting	15
11、 Wiring circuit	24

FEATURES

- 300mm diameter porthole, door may be open at a 180 degrees.

Facilitate view of wash process, facilitate unloading and easy to use with large port.

- Class A energy-saving,Class A washing performance

Scientific design for tub can reduce the use of water heavy during washing, consequently upgrade the energy efficiency class to A,also use scientific washing

- Multi-gear speed controller

According to different costuming, you can select corresponding spin speed, from 400 to 1000 rpm.

- Unique gasket design featuring no residual water hidden inside.

By the unique gasket, washing machine can left no residual water hidden between outer drum and front board.

- Delay time adjustable.

According to different costuming, you can select delay time, from 0.5h to 24h.

Sale points

One sentence for simplicity:

Tight machine body without any wasting places

Three sentences for convenience:

- I. Choose from 11 programs, convenient uses to provide you much benefit
- II. Front-Load structured to ensure placing clothes much more facility
- III. Humanistic design for control panel to help expedient operation

Five sentences for tech-support:

- I. No need to be worried because of the function of intelligent-memory
- II. Satisfied to encourage children's curiosity because of the child-lock
- III. Perish your trouble because of the alarm to the fault
- IV. Make you happy because of quick-wash in 29 mins
- V. Reassure for you because of the 24hours pre-wash which may offer you washing anywhere and anytime.

SPECIFICATION

	<i>Proposal</i>	2006	New Sensor
	Front loaders washing machines		HW-C1260TVE/ME-U HW-C1460TVE/ME-U
1.	Product identification		
	Description of appliance		Washing machine
	Type of appliance (FS = standing, BI = built-in)		FS
	Supplier own brand		Haier
	Supplier bar code	EAN	Haier
	Mares computer code		Haier
	Commercial Brand / Model		Haier
	Commercial bar code	EAN	Haier
2.	Key-Features		
	Energy efficiency class		A
	Washing performance class		A
	Spin efficiency class		B
	Programs	n°	11
	Capacity	kg	6
	Spin speed (max. / optional)	rpm	1200-400/1400-400
	Noise level (spin)	dB(A)	68.9
	Energy consumption per wash circle *	kWh	1.14
	Water consumption*	l	56
	Residual dampness (spin result)	%	53%
	Spin speed selector switch (steps)	rpm	●
	Spin speed variator (stepless)	rpm	●
	Adjustable thermostat (water temp. adjust from - to)	°C	90/60/50/40/30
	Drum capacity dry laundry / water	kg / l	6/56
	Auto water level adjust (depending on volume of filled in laundry)	AWL	●
	Washing time (max.)	min	210
	Washing temperatures (program-controlled)	°C	30 - 90
	Certification's (CE / ISO 9001 / ISO 9002)		CE / ISO 9001
	Approvals (VDE/GS / TÜV/GS / IMQ)		TÜV
	* EN 60456 (60°C cycle, full load without pre-wash) * = COLD		●
3.	Basics data		
	Unit dimensions (H x W x D)	cm	85 x 59,5 x 56
	Net weight	kg	69
	Voltage/frequency	V/Hz	220-240V~50Hz
	Input power / main fuse (intensity)	W / A	2000/10
	Work top / removable		-/●
	Control M = electromechanical, E = electronic, F = fuzzy		E
	Inner cylinder S = stainless steel / Z = zinc coated		S
	Outer cylinder P = Plastic / S = stainless steel		P
	Door:		
	aesthetic (R = round, Y = big eye, Q = square)		Y
	Diameter	cm	30
	Outer door frame S = stainless steel / M = metal / P = plastic		P
	Inner door G = glass / P = plastic		G
	Detergent compartments	n°	3
	Removable compartment for liquid detergent		-
	Delay timer (from - to)	h	0.5-24
	Self cleaning suds pump		●
	Water inlet hose cold water / hot water		●/-
	Water drain hose / -support		●/●
	Adjustable feet	n°	4
4.	Safety systems		
	Auto door lock	ADL	●
	Motor overheating protection	MOP	●
	No heating without water	NHW	●
	Auto water cool-down (before drain 90°C boiled water)	AWC	●
	ACQUA Stop kit		-

	Child protection		●
	Programs		
5.	1) Strong action /cotton cycles	n°	1
	2) Normal action / synthetics	n°	1
	3) Delicate action / wool cycles	n°	1
	Pre-wash / wash		●/-
	Quick wash / super quick wash		●/-
	Rinse / soften		●/-
	Delicate / hand wash		-/●
	Wool / cashmere		●/-
	Soak / spin		-/●
	Drain		●
	Easy ironing		-
	Optional function keys (additional program settings)		
	ON/OFF button		●
	Half load		-
	Fussy		●
	Spin exclusion		●
	Spin reduction	rpm	●
	High water level		●
	No Soak		●
	Rinse stop		-
	Delicate		-
	Cold wash	❄	●
	Sport wash		●
	ECO		●







● Stand for having the function

- Stand for not having the function

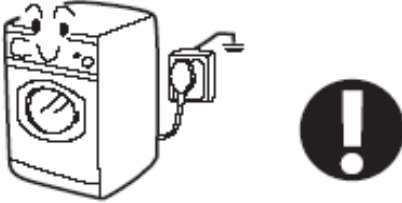
ECO stand for economical wash

Matters Needing Attention

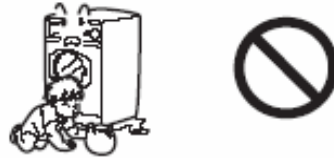
Safety

<p>1. A separate earthed socket is required for the power supply. The socket should be reachable by the power cable of the machine.</p> 	<p>2. Hold the plug and not the electric cable when unplugging the power supply.</p> 
<p>3. Fuses in the power circuit should be rated for 15A.</p> 	<p>4. Do not touch or use the washing machine bare-footed or when the hands or feet are wet.</p> 
<p>5. Do not use flammable detergent or dry cleaning agent; do not use flammable spray in close vicinity to the washing machine; do not remove or insert the plug in the presence of flammable gas.</p> 	<p>6. The door of the washing machine will become hot during the heating process. Avoid contact with the door during the heating process.</p> 
<p>7. Keep children away from the packing materials after unpacked.</p> 	

Matters Needing Attention

8. The washing machine should not be installed outdoors or in a damp place. In the event of water leakage or splashes allow the machine to dry naturally.

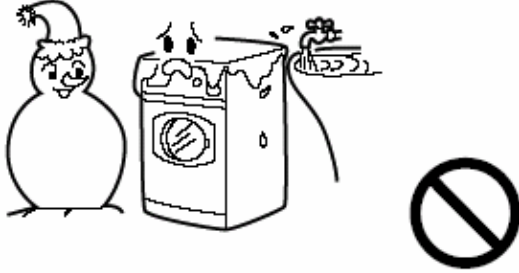

9. Do not place the washing machine directly on a carpet, or close to a wall or furniture.

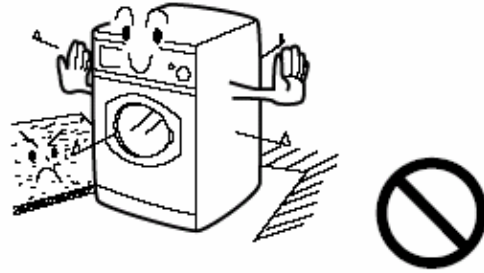

10. Keep away from heat sources and direct sunlight to prevent plastic and rubber components from aging.

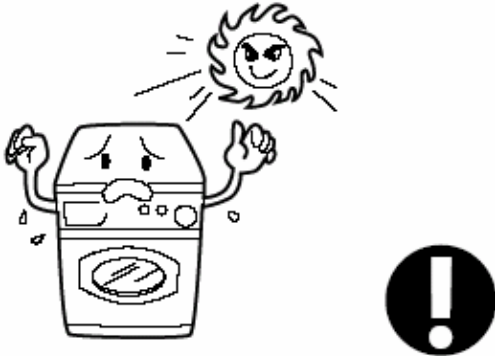

11. During installation, ensure that the electric cable is not trapped by the washing machine and avoid damage to the electric cable.

If the supply cord is damaged, it must be replaced by the manufacturer, its service agent or similarly qualified persons in order to avoid a hazard.

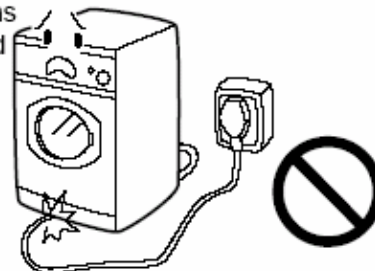

● During Use

1. Before use, check the joints of the filling hose, the tap and the drainage hose for possible problems from water pressure fluctuations. If joints are loose or there is leakage, turn off the tap and repair. Do not use the washing machine until the hose are properly fixed.





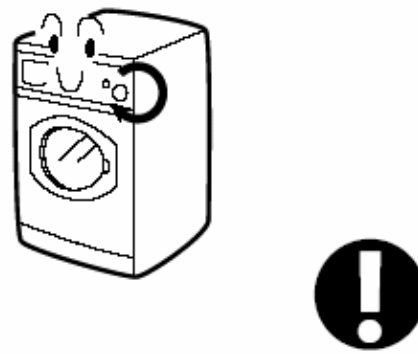

Note: That the appliance is to be connected to the water mains using new hose-sets and that old hose-sets should not be used

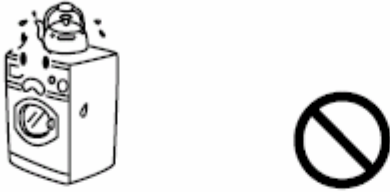

2. To select a program, simply turn the knob clockwise or counterclockwise.

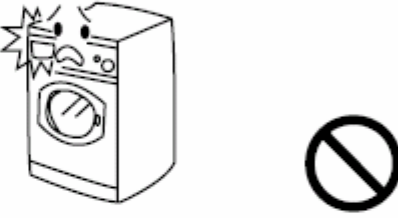

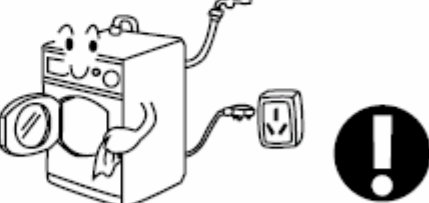
Matters Needing Attention

<p>3. Do not place heavy, heating source or wet articles on the top of the washing machine.</p> 	<p>4. Do not hot wash foam rubber or sponge-like materials.</p> 
<p>5. Before washing, do up zippers, buttons and clothes straps and put small articles, such as socks, laces or bras, into a washing bag or a pillow.</p> <p>Steel wires in bras will pop out during washing; never wash bras containing steel wires.</p> 	<p>6. Do not open the detergent distribution drawer during the wash cycle.</p> 
<p>7. The door is fitted with a self-lock device and will not open until 2~3 minutes after the washing machine stops. Do not force the door open. Do not open the door if water level can reach the porthole.</p> 	<p>8. After each wash program, turn off the tap to prevent leakage; and unplug the washing machine and wipe clean the lower part of the porthole.</p> 
<p>9. Keep the door slightly open when the washing machine is not in use to prevent formation of odors; do not cover the washing machine with plastic cover so that inside dampness cannot be kept in.</p> 	

Installation

- Remove all the packing materials to prevent vibration during use. Upon opening of the package, water drops may be seen on the plastic bag and the porthole. This is normal phenomenon resulting from water test in the factory, as shown in Fig 1.

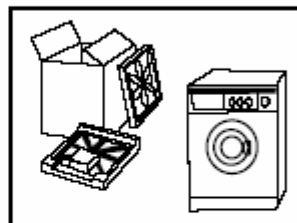

Fig. 1

- Dismantle the packing bolts as shown in Fig. 2. The packing bolts are designed for clamping anti-vibration components inside of the washing machine during the transportation process. Before use:

1. Remove the back plate;
2. Remove the three packing bolts on the back plate and take out the rubber hose;
3. Replace the back plate;
4. Fill the holes left by the packing bolts with plastic plugs.

(Attention: The packing bolts and rubber hose should be kept in a safe place for later use)

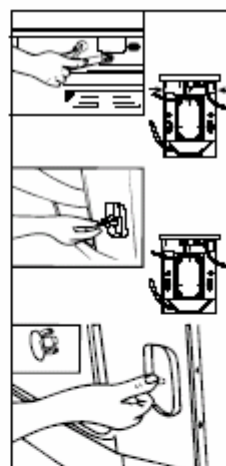

Fig. 2

- Adjusting the washing machine

There are adjustable feet under the bottom of the washing machine. Before use, the washing machine should be adjusted, as shown in Fig. 3, so that it is level.

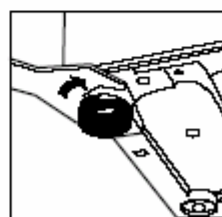
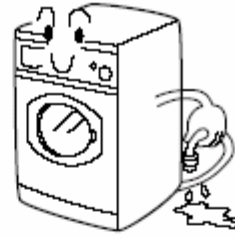
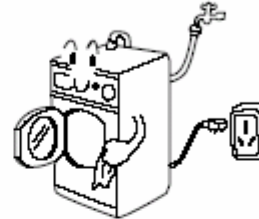

Fig. 3

1. Turn off the water tap and pull out electricity plug after each wash. Open the porthole to prevent formation of moisture and odors. If the washing machine is left idle for a long period, drain the water in the machine and replace the drainage hose.



2. Unplug the machine during cleaning and maintenance. Use a soft cloth dampened with soap liquid to clean the machine case and rubber components. Do not use organic chemicals or corrosive solvents.



3. Clean the detergent distribution drawer regularly.

Swing out the drawer, flush it clean with water and then replace it.

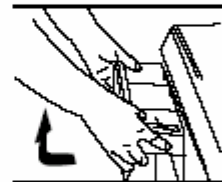

4. Clean the filter Cleaning methods (once a month)

- 1) Push out the outer cover (Fig. 1);
- 2)Screw out filter by turning counterclockwise (Fig. 2);
- 3) Flash clean with running water;
- 4) Replace the filter by turning clockwise and remount the cover.(Fig .3)

Caution: The filter must be turned clockwise to one suitable place, make sure it does not lead to leakage.

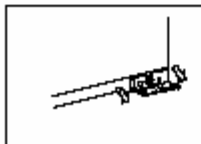

Fig1

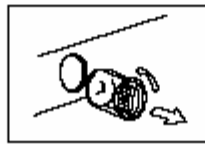

Fig2

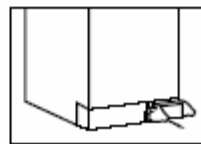
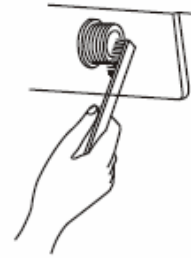

Fig3

Maintenance

5. To prevent blockage to the water supply by ingress of foreign substances, clean the water inlet and inlet filter regularly.



6. If the machine is to be moved to a distant place, replace the vibration absorbing locks (packing screws, rubber gaskets) removed before installation to prevent damage as shown below.

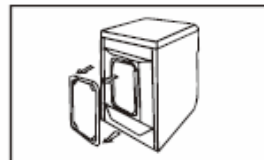

Remove the back cover and take out the three rubber plugs.



Insert the channel steel vibration locks.

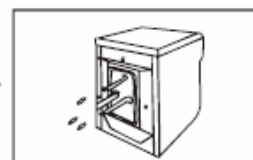

Insert the rubber bolt gaskets.

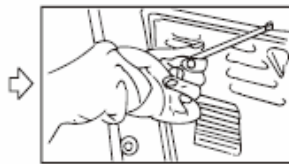

Replace the back cover.

7. If the washing machine is left idle for a long period, pull out the electrical plug and turn off the water tap. Open the door to prevent formation of moisture and odors. Let the door open while not used.

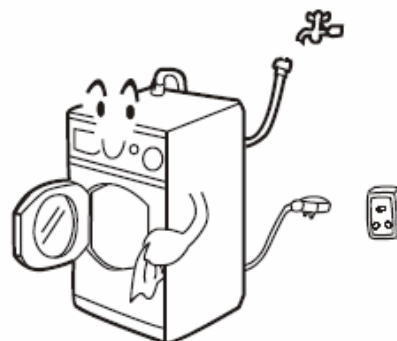

Net dimension



Names of the parts

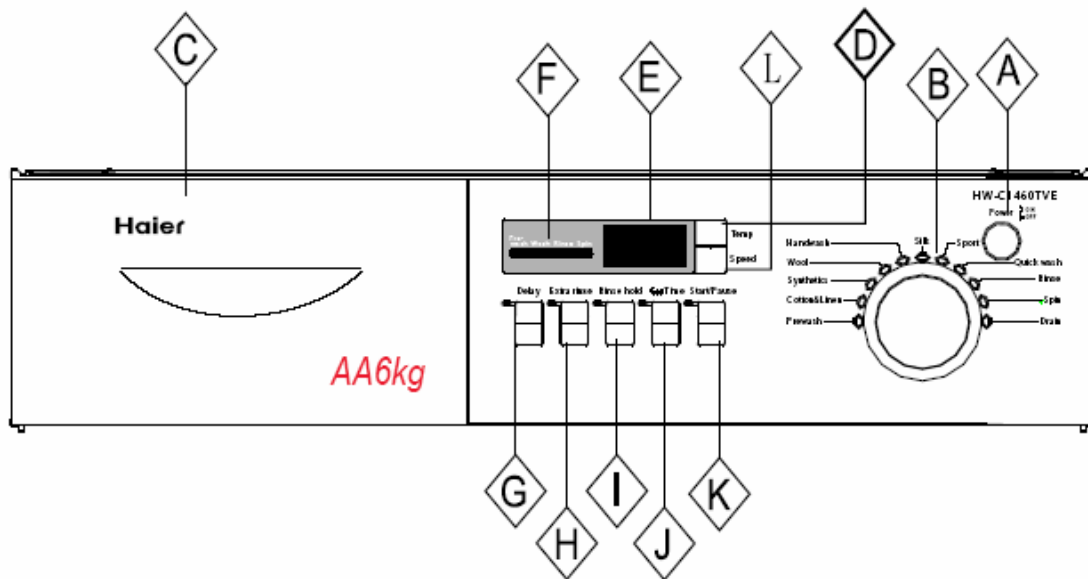
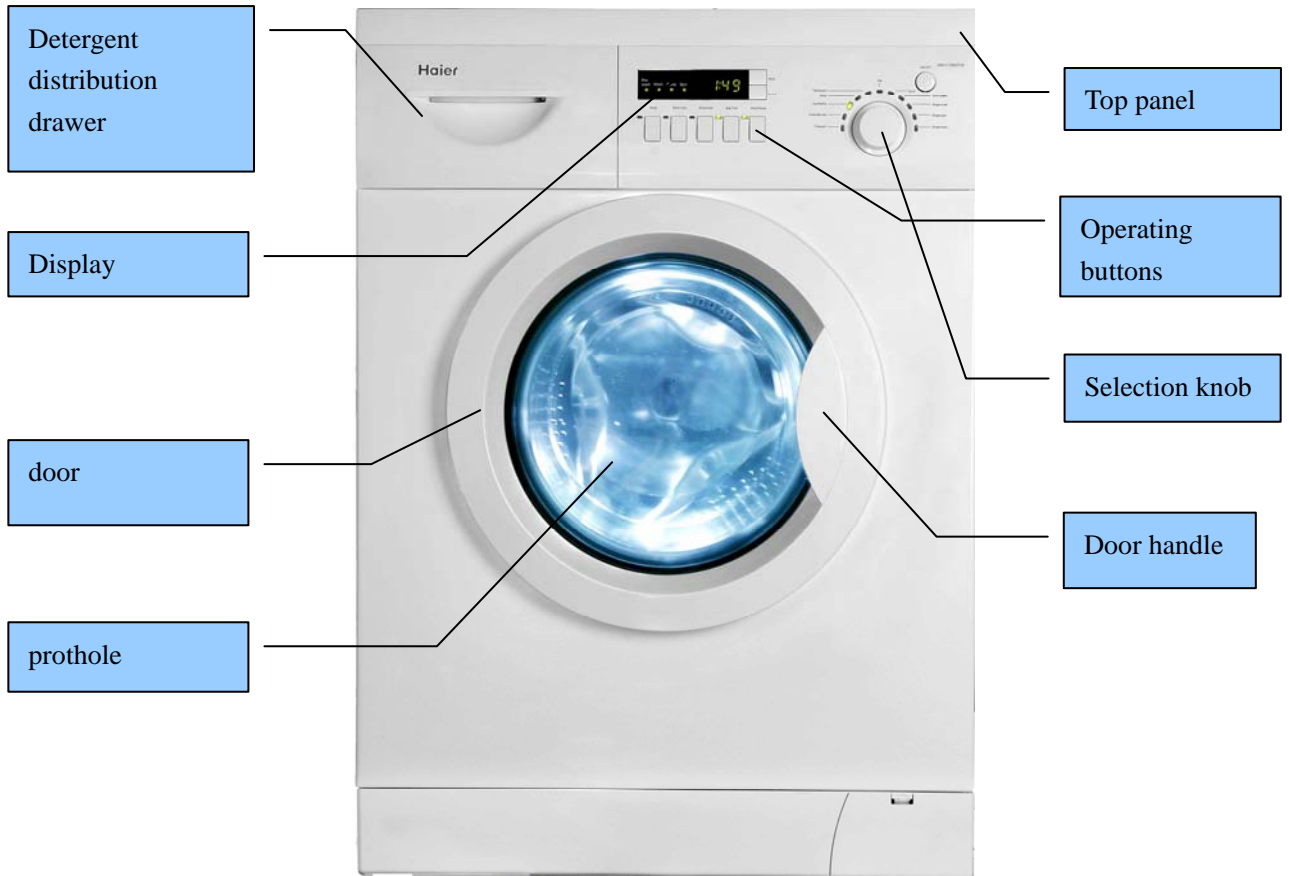

Operational Functions

A : Power Switch

Press this button to switch on the washing machine. Press it again to switch it off.

B: Wash programming knob

By turning the knob clockwise/counterclockwise, the required program can be selected.
(Refer to Guide to Operational Program Selection).

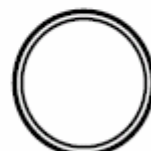
**C : Detergent distribution drawer**

Open the drawer, three compartments can be seen:

Compartment 1: Pre-wash detergent

Compartment 2: Normal - Quick wash detergent

Compartment 3: Softener, conditioning agent, perfume, etc.

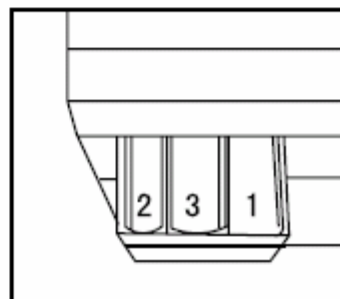
**D: Washing temperature knob**

Touch this button lightly to select the required temperature (when a temperature is selected, the corresponding indicator will go on).

E : Display

Such information as remaining wash time, temperature and speed setting and error messages will be shown.

Note: After power is switched on, the display will go on and the remaining wash time decreases. As the water pressure and temperature may differ, the remaining time may be adjusted accordingly. When the laundry is not balanced during spinning, the time may be automatically prolonged. These are normal phenomena.

F : Washing indicator

It indicates the washing process of the selected program. When the light is on, it shows that the washing process being indicated is running.

G : Delay Button

Touch this button lightly, the washing machine will start operation after a period of time and the corresponding indicator will go on. The range is 0.5-24 hours; each touch of this button increases a half hour. After the button is set, press the Start/Pause button to start countdown of the set time (the time is displayed on the screen until the program ends).

Note:The delay time must be longer than the program time;otherwise,the washing machine will start the wash program directly.

H : Extra rinse button

Touch this button lightly, the indicator will go on. An additional rinse operation will be activated.

Note: Select this function when programe 1-6 or 9 is selected.

I : Rinse hold button

Touch this button lightly, the overhead indicator will go on. When the washing machine is at the last rinsing operation, it will not drain but to start a soaking cycle. Now "hold" will appear on the display. If you want to spin the laundry, press this button again, the indicator will go off and operation will resume.

Note: Select this function when "prewash","cotton&linen","synthetics" "single rinse" is selected.

J : Eco Time button

Before a washing program, press this button to set the required washing load (L-1~L-A), the washing machine will automatically adjust the water consumption, heating time and washing time. Users can select the washing load as required for economical operation.

Note: 1. "L 1-A" refers to the five levels of washing load. If the laundry is more than half of the drum content, it is recommended to select L-4 ~ L-A; otherwise, select L-1~L-3.
2.For"synthetics","sport" and "quick wash" ,you can only select L-1~L-3
3. Please adjust the detergent quantity as per the washing load selected

K : Start / Pause button

When the washing machine is plugged and a program is selected, lightly touch this button to start operation. During a wash cycle, touch it lightly, the display will begin blinking and operation will stop. Touch it again to resume operation.

L : Spinning speed setting button

Touch this button lightly to select the desired speed. There are speed indicators over this button.

For knitted sweater and other laundries, if washing machine doesn' t spin, please rechoose the spin program.

Note: Please refer to Guide to Operational Program Selection and Washing Instructions for the required washing temperature and spinning speed for different laundry. If you have no specific requirements, please use default settings.

Special Functions

1. Control panel lock function: To prevent children from accidentally changing the settings. Press "Delay" and "Start/pause" at the same time, this function will work and the "Lock" sign and the remaining program time will appear alternatively. When this function is on, all other buttons are locked. Press the two buttons again to unlock.

2. Power-off memory function: This machine has power-off memory function. In case of abrupt power failure or the power must be cut off during a program cycle, the present settings will be saved and the preset operation will resume when the power is on again.

Note:

1.If you want to stop the program setting,at first,you should pressthe button of start/pause only one time.Then turn off power, .If you want to start the program setting again,you should turn on the power again,so it is ok.

2.Switch on the power, press the “extra rinse” button and the “rinse hold” button at same time, the washing machine will be in self check mode.

1) When the door switch is closed for ten seconds, 88:88 will be displayed.

2) When the main wash valve allows water to let in for 3 seconds, 77:77 will be displayed.

3) When the pre-wash valve allows water to let in for 3 seconds, 77:77 will be displayed.

4) When the hot water valve allows water to let in for 3 seconds, 77:77 will be displayed.

5) When the main wash valve, the pre-wash valve and and also the hot water valve allow water to let in for 3 seconds at the same time, 77:77 will be displayed.

6) When the motor runs for ten seconds with the spin speed 93rpm, 66:66 will be displayed.

7) When the motor runs for 50 seconds with the spin speed 800rpm, 66:66 will be displayed.

8) When the main wash and pre-wash allow the water to go in meanwhile until the maxim water level, 55:55 will be displayed.

9) When the water fills the tub fully, it will stop for ten seconds and at this time 55:55 will be displayed.

10) When the motor runs clockwise for 15 seconds with 50 rpm, the washing machine will stop for 5 seconds and at this time 44:44 will be displayed.

11) When the washing machine heats water for 10 seconds, 33:33 will be displayed.

12) When the washing machine drains for 30 seconds, 22:22 will be displayed.

13) When a program cycle is finished, END will be displayed.

HW-C1260/1460TVE/ME-U Error Display and Troubleshooting



Error message:Door is not properly shut 20s after program is started.

Troubleshooting:

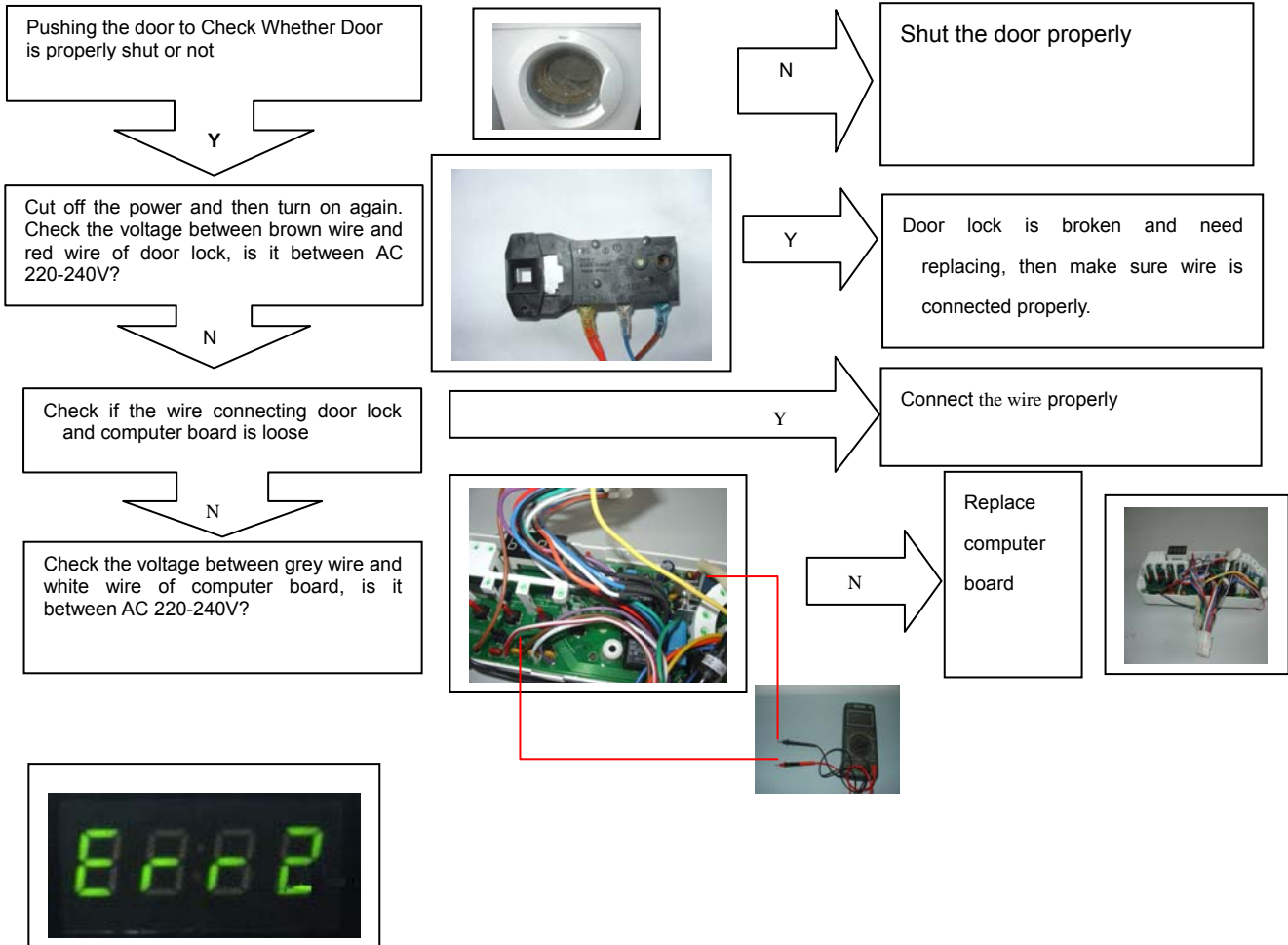

Error message:Drainage error, water not emptied within 4 min.

Troubleshooting:

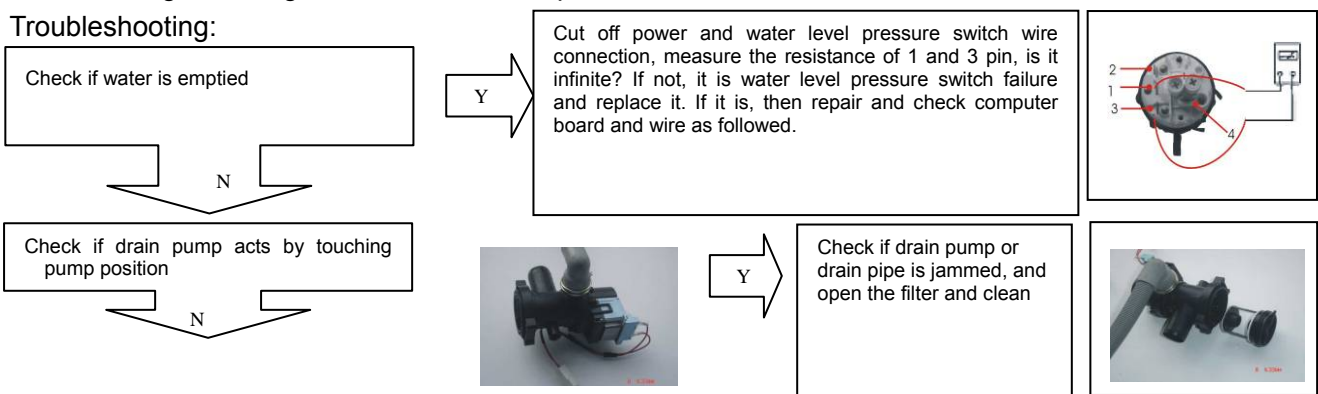

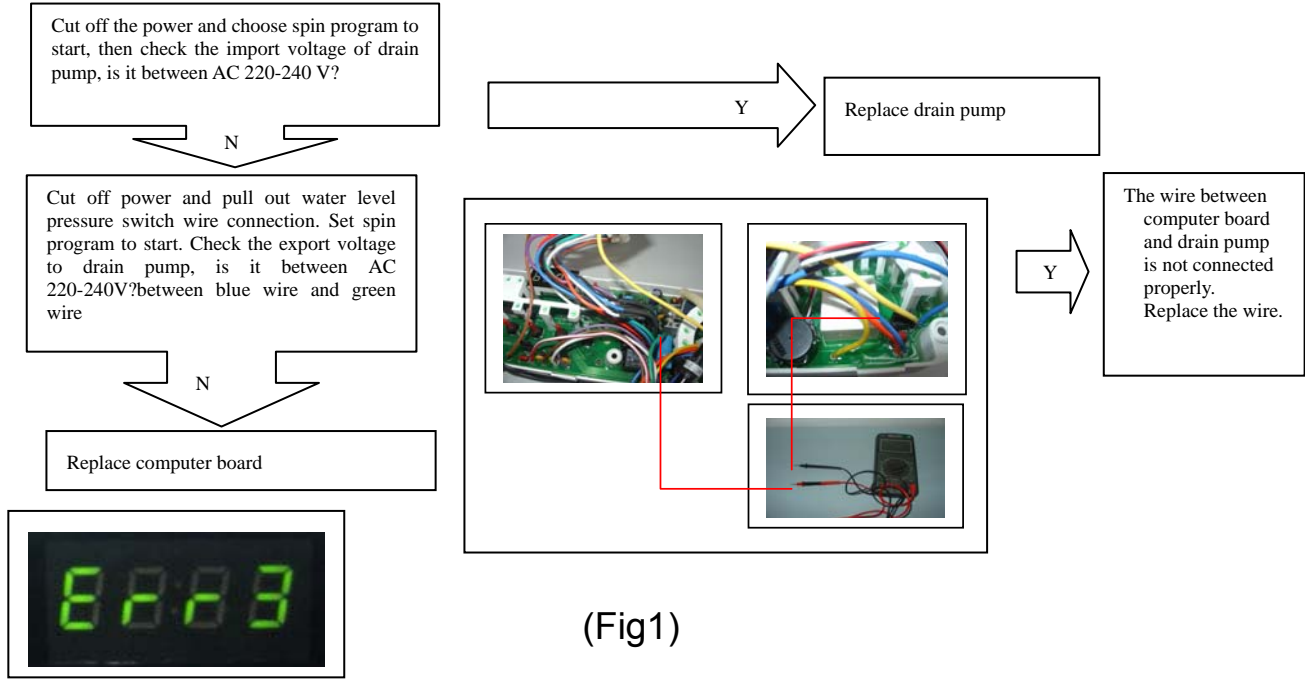

Error message:Temperature sensor is not properly connected or damaged (display at the end of a program).

Troubleshooting:

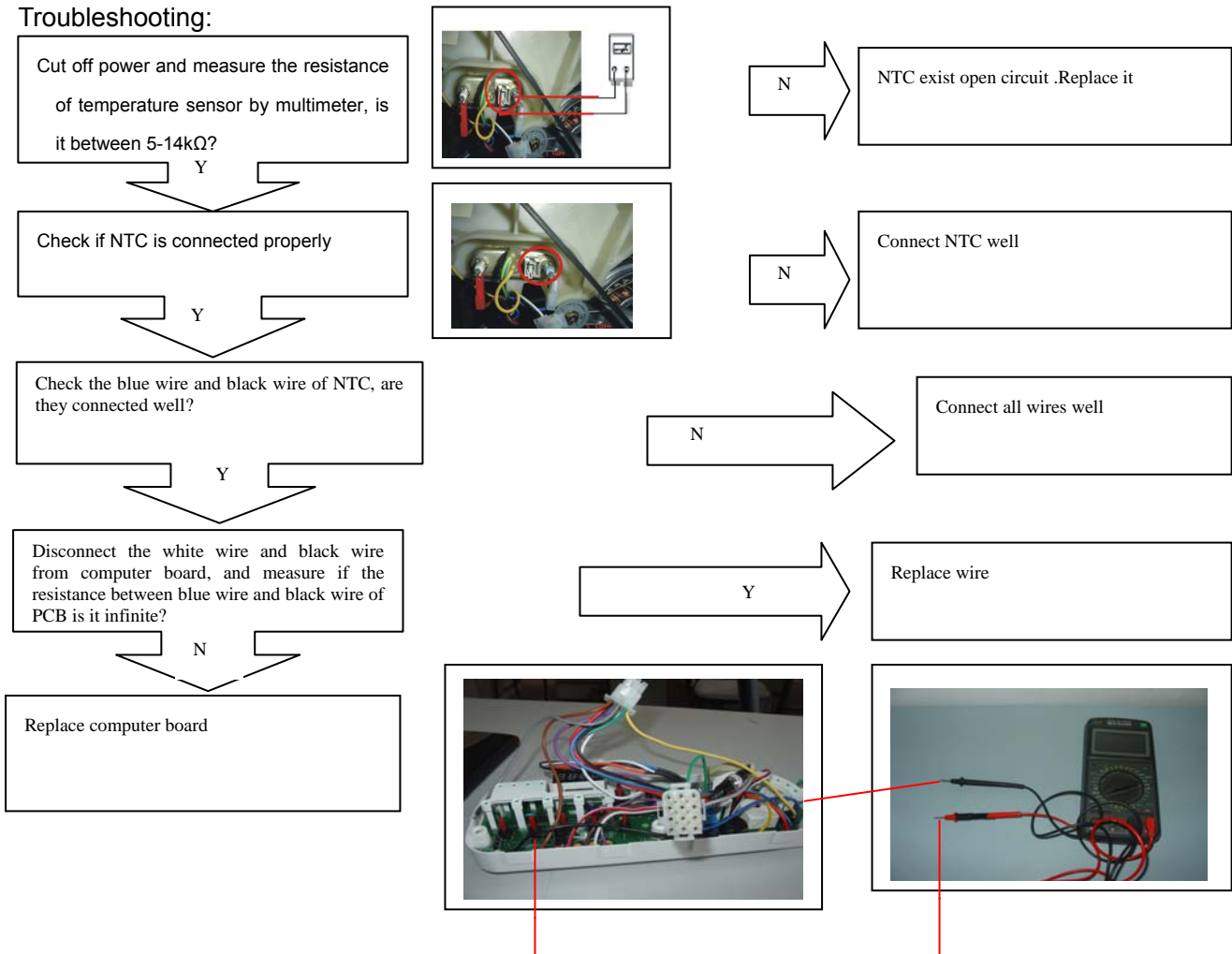



Error message :The heater may be broken

Troubleshooting:

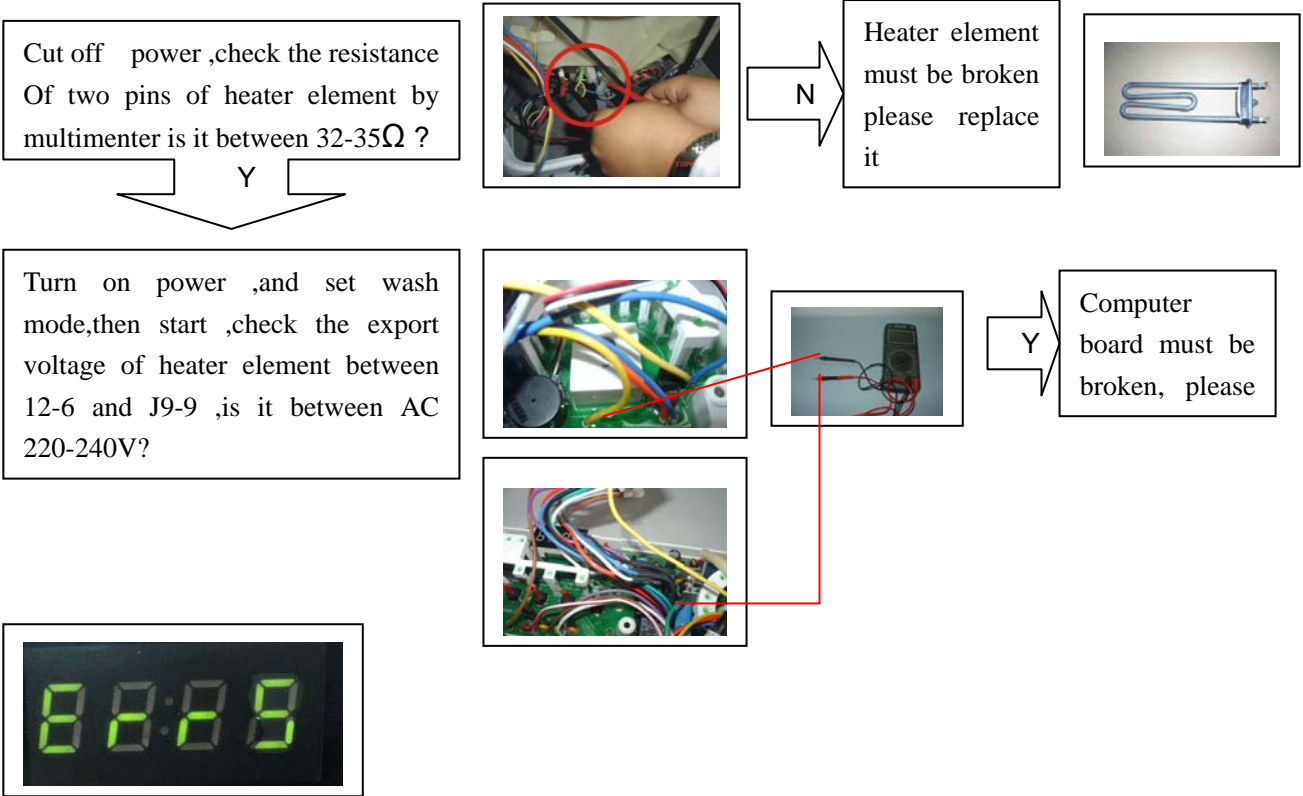

Error message: The required water level is not reached within 8 min.

Troubleshooting:

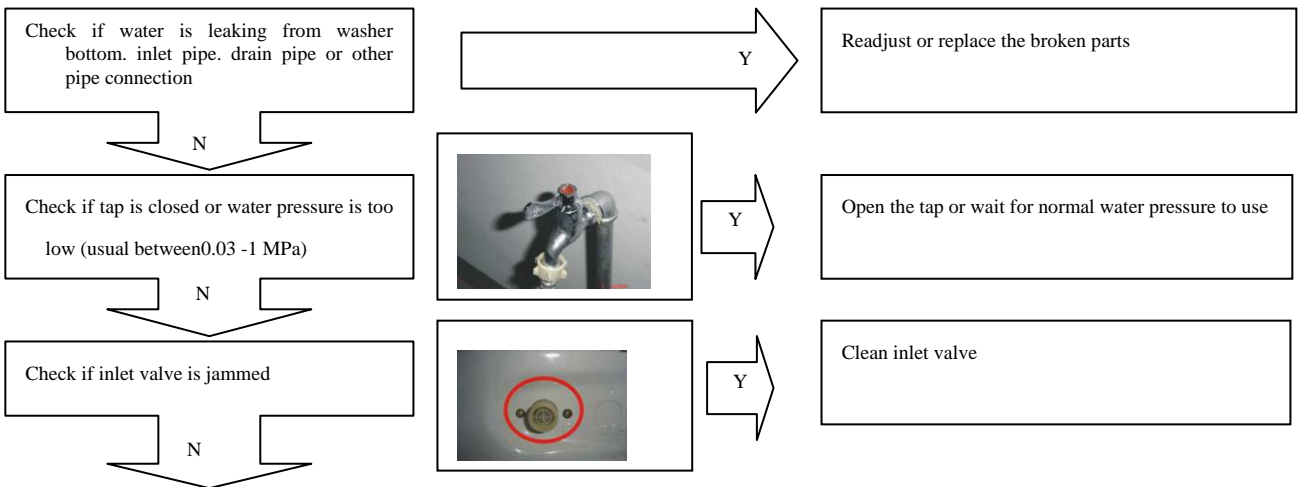

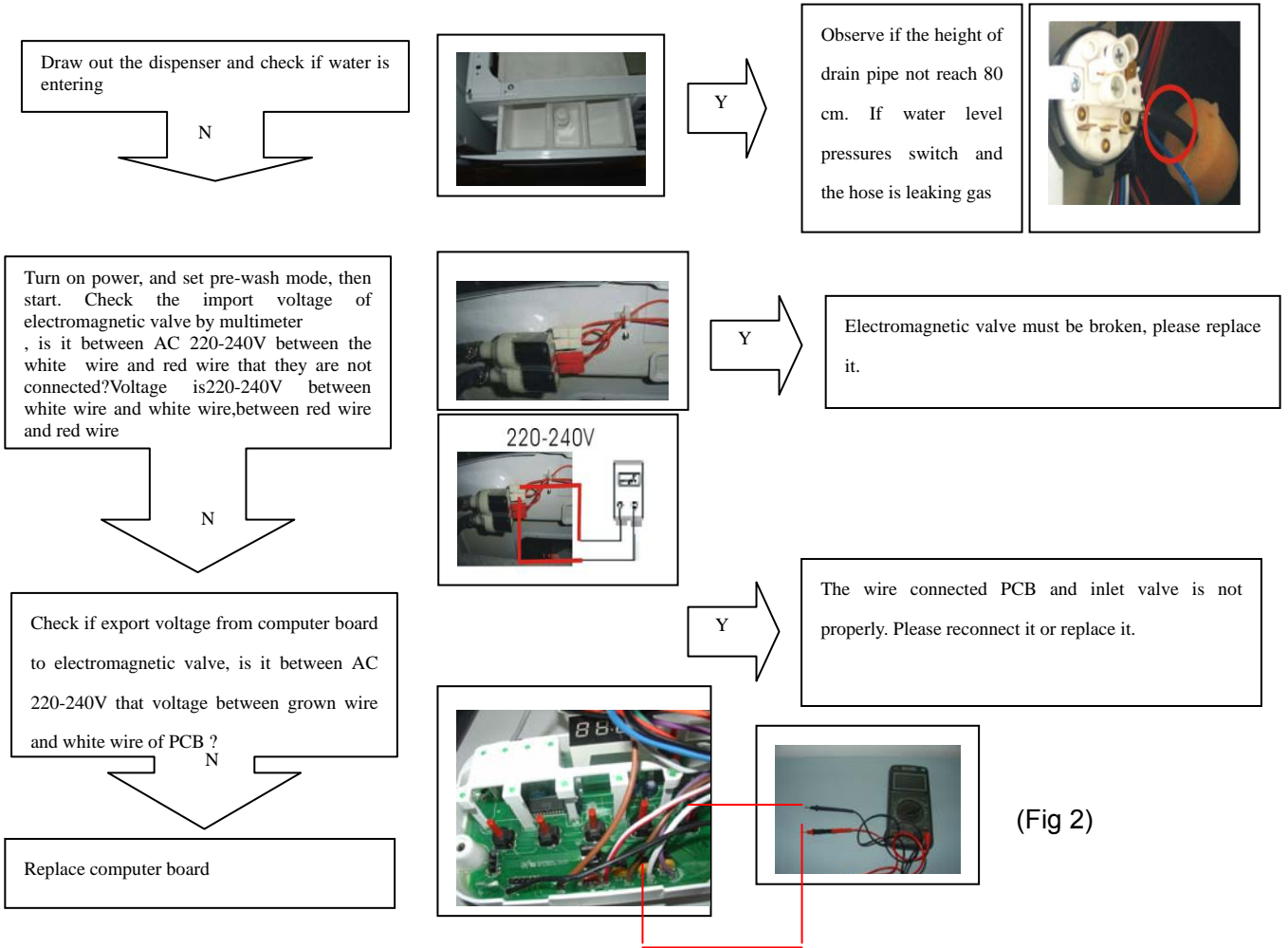



Error message: Motor speed error .it may be not properly connected or damaged.

Troubleshooting :

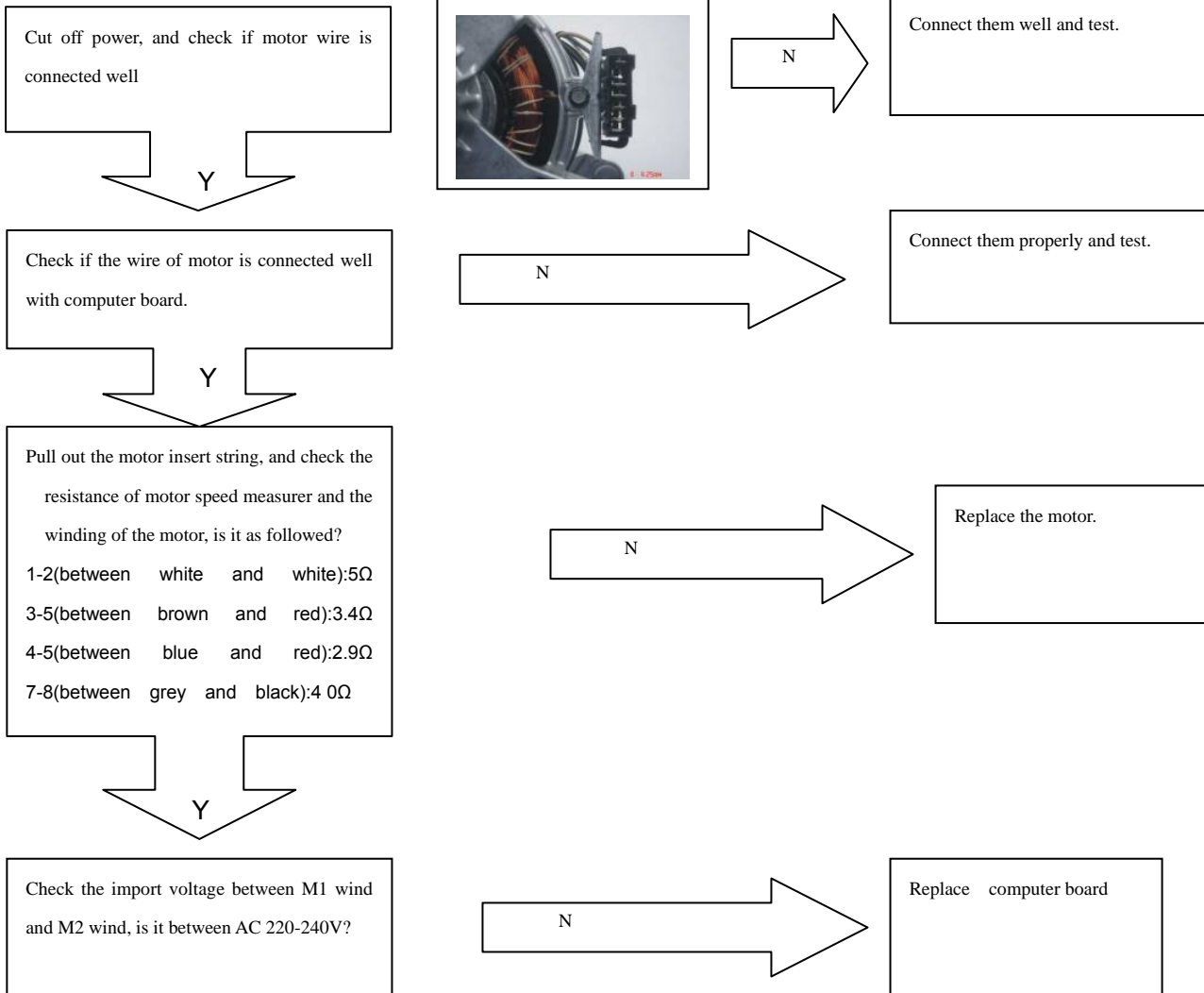



Error message. Motor overheat protection or is damaged.

Troubleshooting:

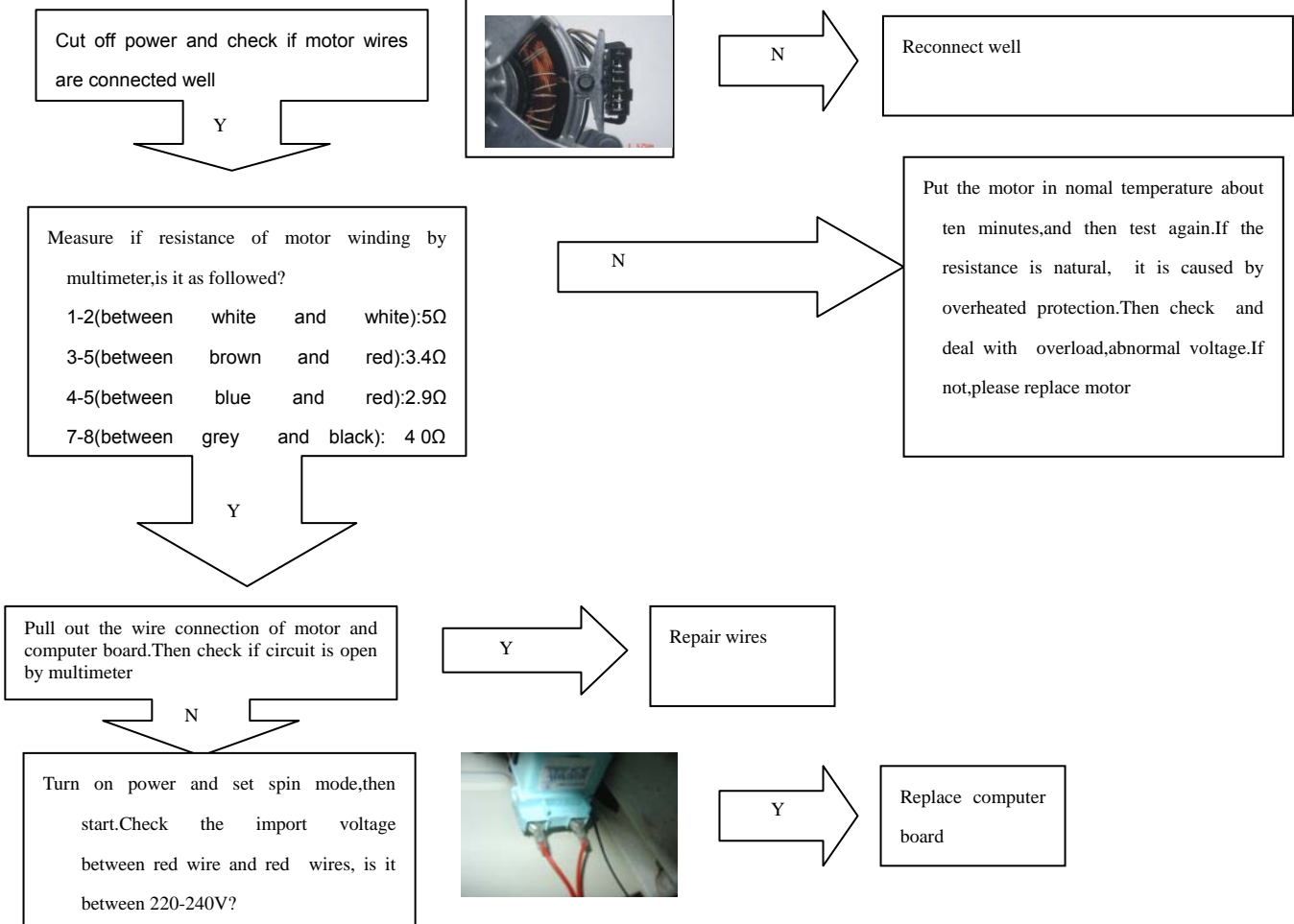



Error message. Water level exceeds protection value.

Troubleshooting:

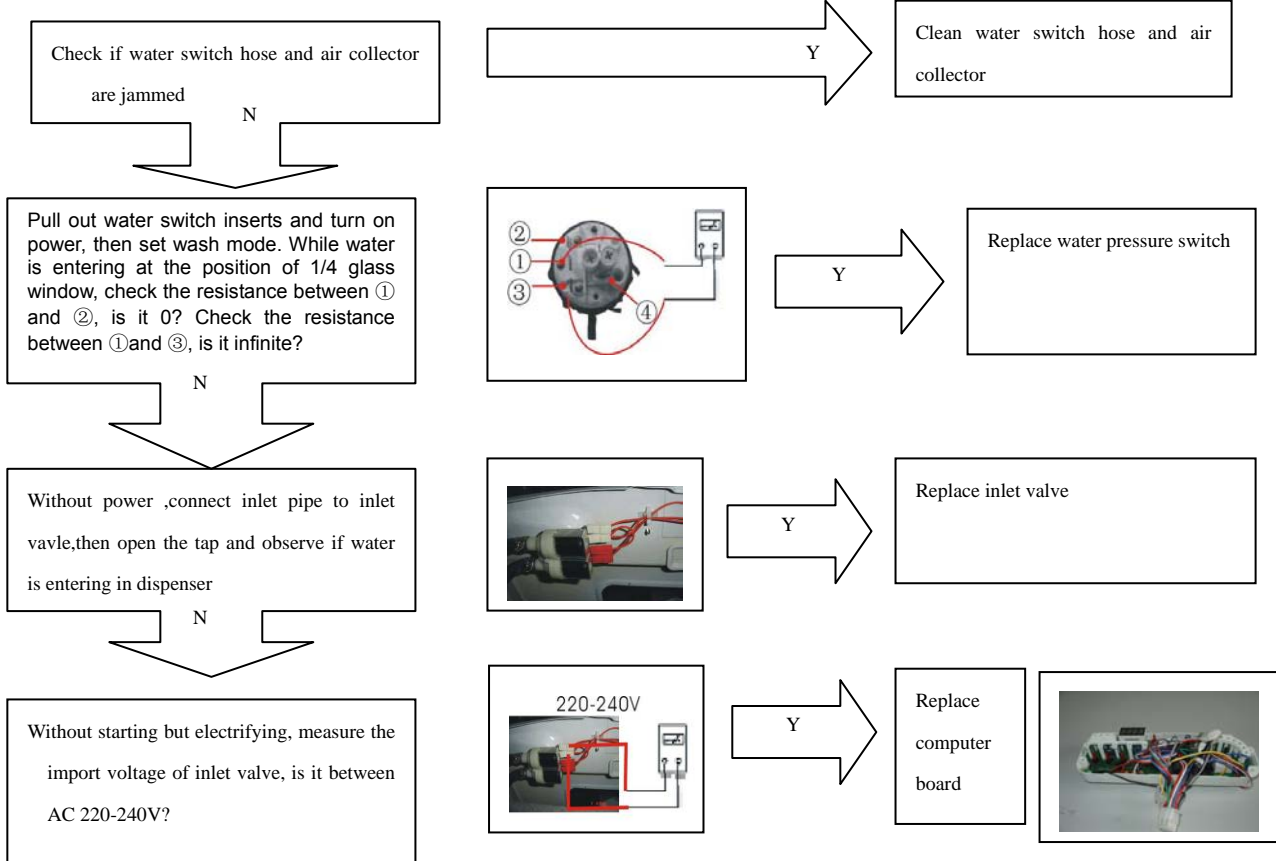

HW-C1260/1460TVE/ME-U Examination & Troubleshooting

Failure: Display nothing

Troubleshooting:

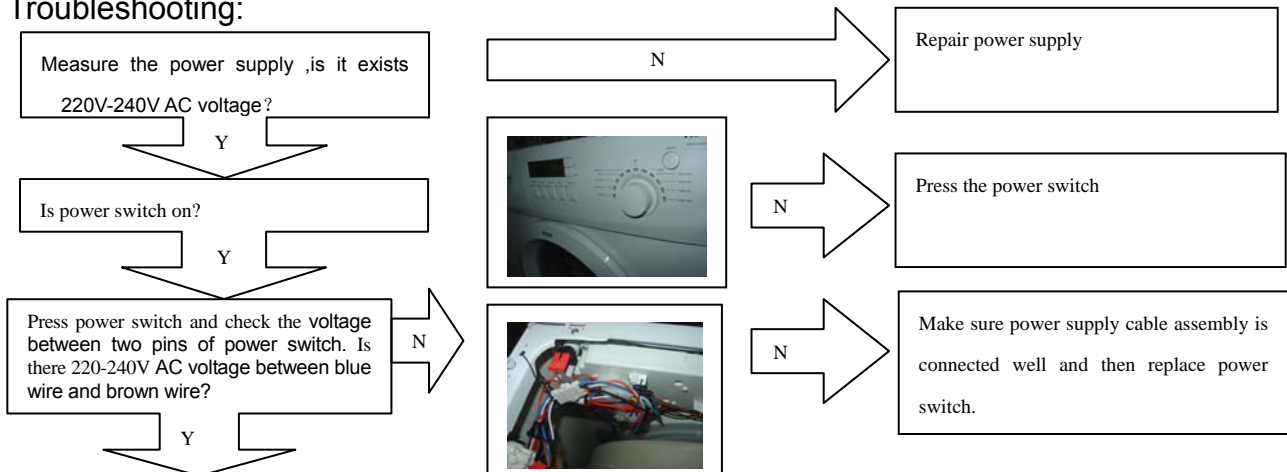

Cut off power and check if plugs are connected well by pulling the plug of computer board.



Y → Insert the plug well and test

Check if power plug exists 220V-240V AC voltage at the import pin



N → Replace PCB

**Failure:no water inletting
Troubleshooting:**

Is the tap shut off or the water pressure too low?



Y → Open tap or wait for normal water pressure

Check if water is leaking from washer connection, especially between inlet pipe and tap. to make sure of no bends.

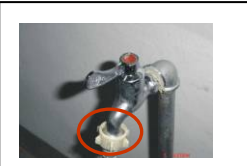

Y → Reconnect inlet pipe.

Check if filter of electromagnetic valve is jammed



Y → Clean filter

Choose pre-wash program and start. Check if there is 220-240V at import pin of electromagnetic valve

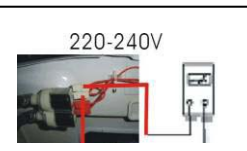

Y → Replace electromagnetic valve

Is there open circuit between electromagnetic valve and computer board?

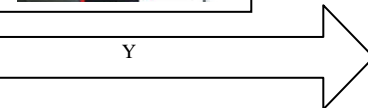

Y → Reconnect the wire

Choose pre-wash program and start. then check if there is 220-240V at export pin of electromagnetic valve

(See fig 2)
N → Replace PCB

**Failure:no draining
Troubleshooting:**

Is the height of drain pipe too high?

Y → Adjust the height of drain pipe to 80-100 cm

Turn filter anticlockwise. open and check if filter is jammed



Y → Clean and tighten filter clockwise.

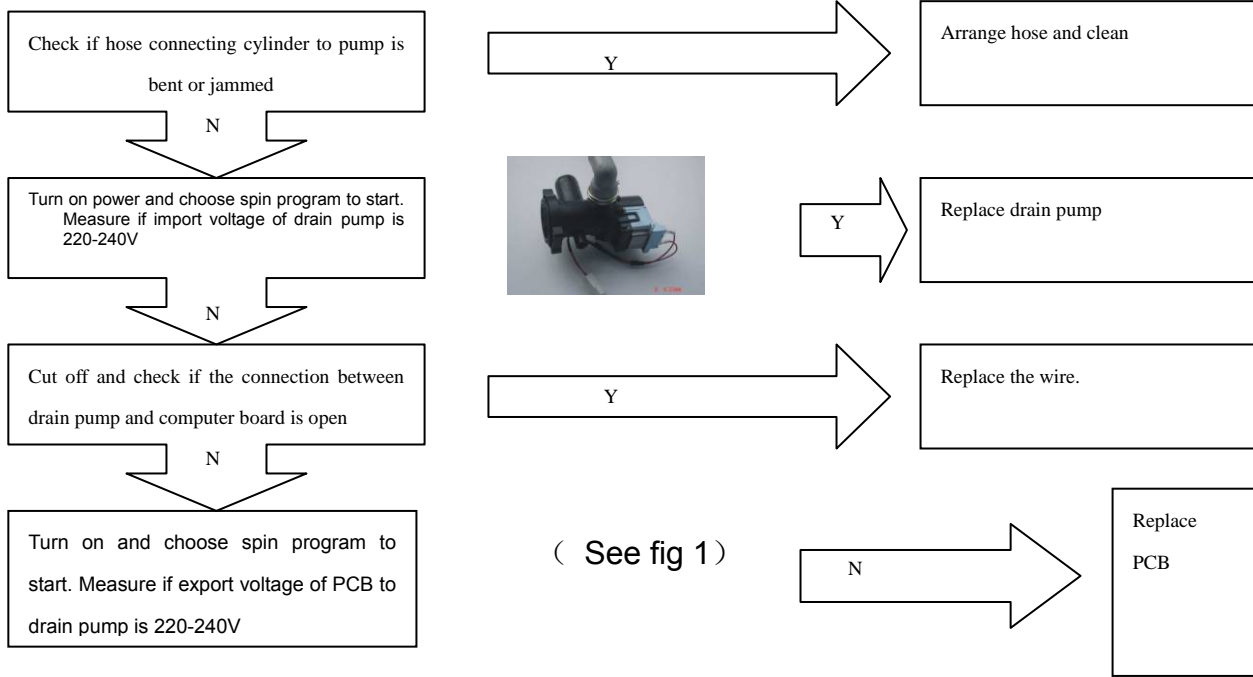

Failure :abnormal noise and vibration

Troubleshooting:

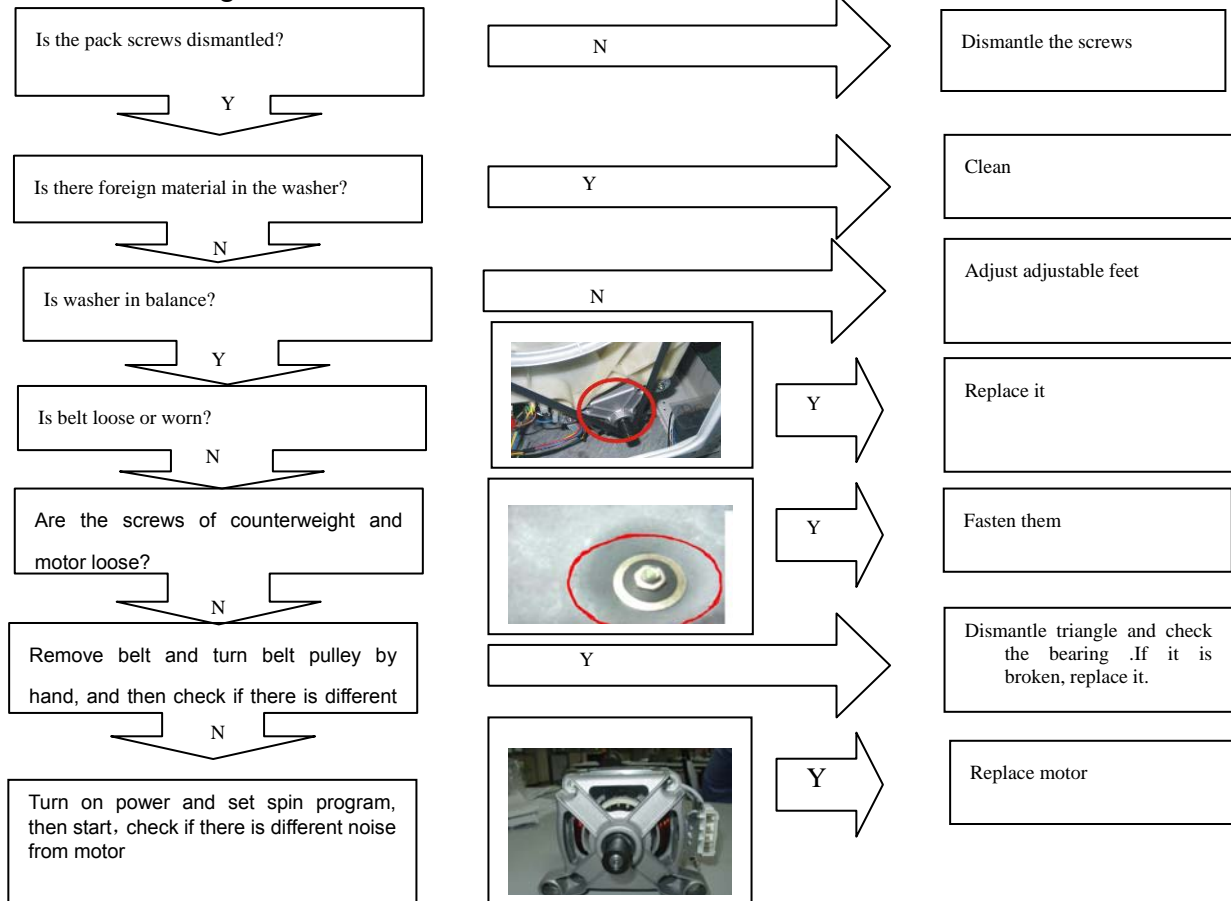

Failure:water leaking

Troubleshooting:

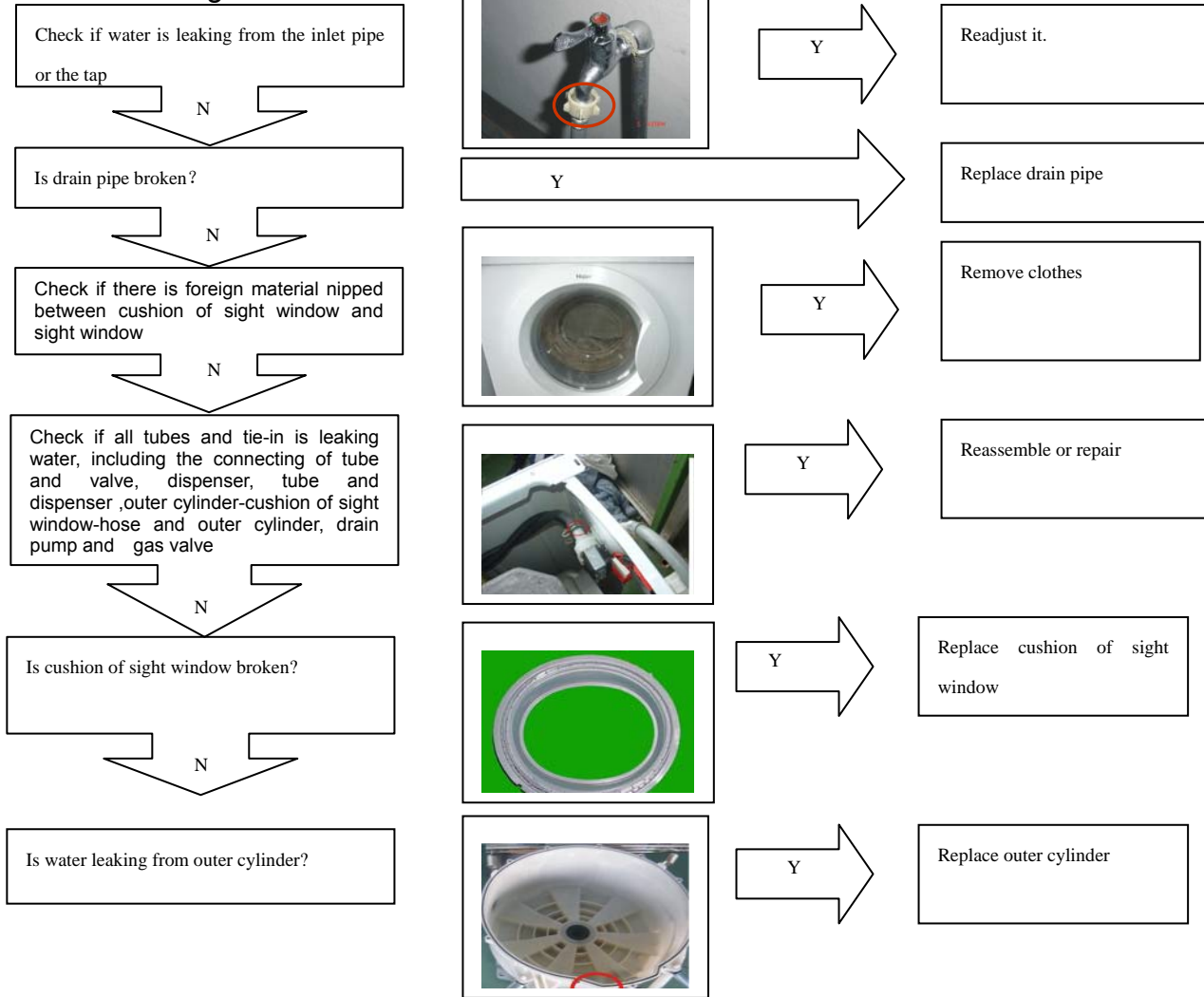

Wiring circuit

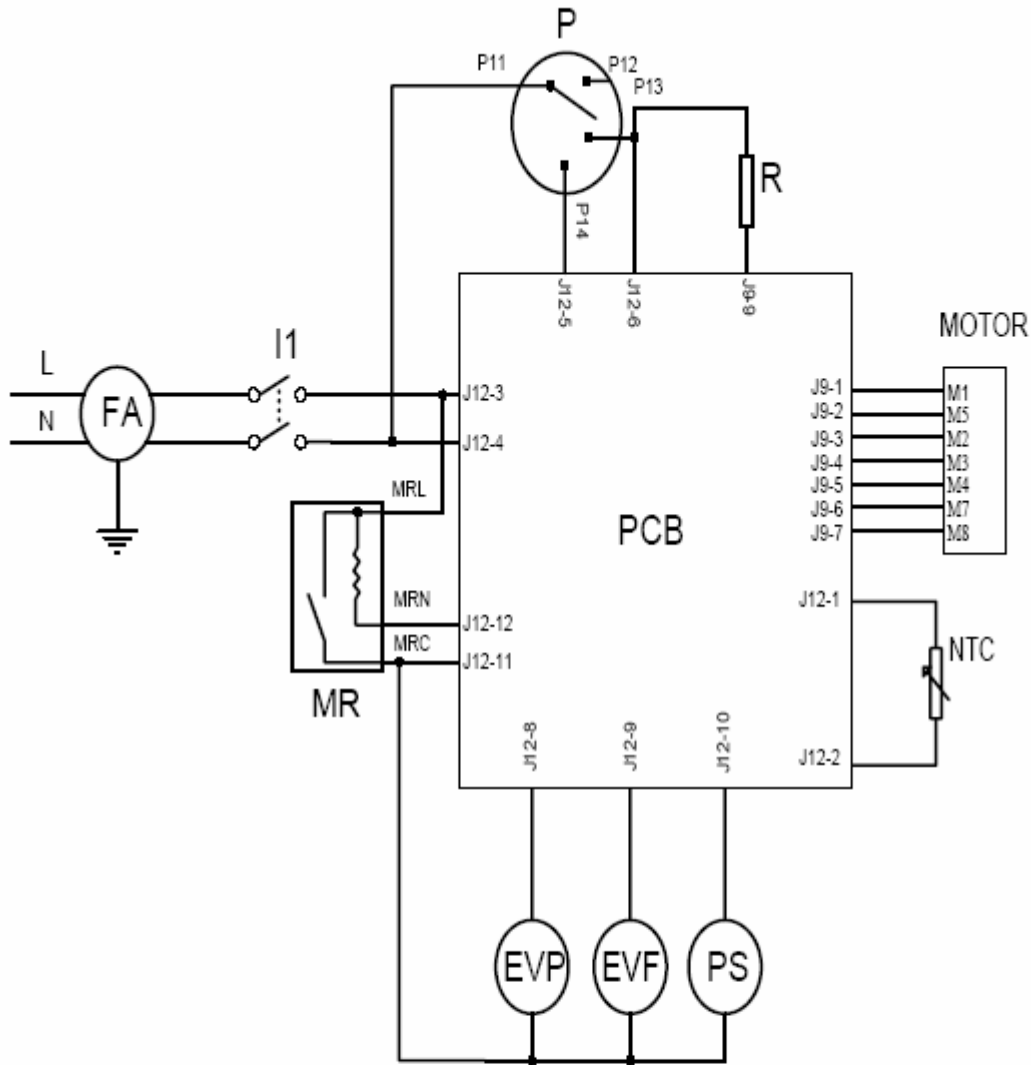

Motor-Motor
 PCB-Printed circuit board
 MR-Door lock
 R-Heating element
 PS-Drainage pump
 EVF,EVP-Water valve
 I1-on/off

P-Pressure switch
 FA-Interference suppresser
 NTC-Temperature sensor

Sincere Forever

Haier Group

Haier Industrial Park, No.1, Road

266101, Qingdao, Haier China

<http://www.haier.com>

Free Manuals Download Website

<http://myh66.com>

<http://usermanuals.us>

<http://www.somanuals.com>

<http://www.4manuals.cc>

<http://www.manual-lib.com>

<http://www.404manual.com>

<http://www.luxmanual.com>

<http://aubethermostatmanual.com>

Golf course search by state

<http://golfingnear.com>

Email search by domain

<http://emailbydomain.com>

Auto manuals search

<http://auto.somanuals.com>

TV manuals search

<http://tv.somanuals.com>