

Fully Automatic Washing Machine

User's manual



This manual is for
HWM88-0566T

- Special number:0030507833B
- Please read this manual carefully before using.
- Retain it for future reference.





CONTENTS

- Specification tablethe 2nd cover
- Names of the parts..... 1
- Safety precautions..... 2
- Installation and adjustment..... 4
- Install the water inlet hose..... 6
- Preparation before washing..... 8
- Put in the laundries 9
- Usage of the detergent..... 9
- Close the top lid..... 9
- Use the operation buttons..... 10
- Finish washing..... 13
- Disposal after washing..... 14
- Trouble-shooting answer to question..... 15
- Packing list 16

Specification table

Water level/Water quantity (about)	1/20L、2/40L、3/56L、4/72L
Water Injection pressure	0.03MPa ~ 1MPa
Standard Rated washing / spinning capacity	8.0kg/8.0kg

Packing list

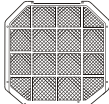
Name	Quantity	Storage position
● User's manual	● One	● Inside the document bag
● Warranty card	● One	● Inside the document bag
● Components of the water inlet hose 	● One	● Inside the accessory bag
● Tapping screws 	● Eight	● Inside the accessory bag
● Bottom plate 	● One	● Between the upper cushion of the washing machine package and the upper seal of the package carton
● Automatic washing machine	● One	

Names of the parts

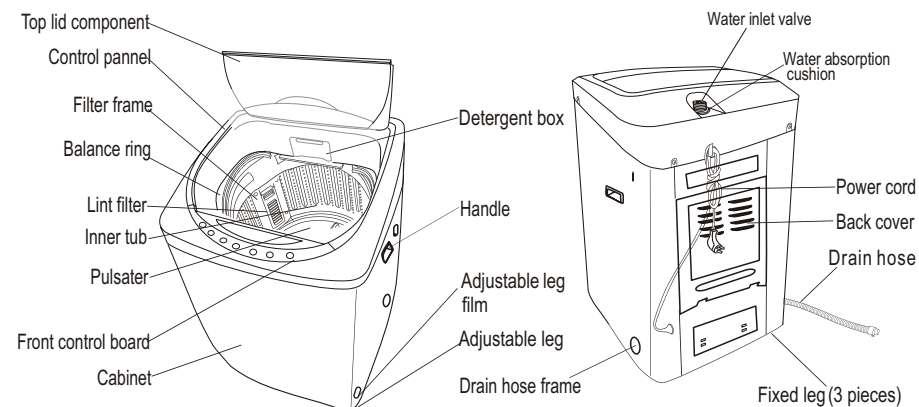

Meaning and description of the symbols

Warning sign



Contents marked with that symbol are related to the safety of the product and the personal safety of the users. Please operate in strict conformity to the contents.

Forbidden sign



Contents marked with that symbol are actions forbidden to perform. Performing of those action may result in damage of the machine or influence the personal safety of the users.

Safety precautions

Please plug the power plug on special receptacle. Be sure to use three-pins power receptacle. Ensure that the earthing prong of the power receptacle is earthed reliably. Use leakage protector if possible.

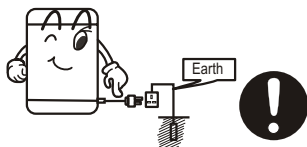

The washing machine must be positioned so that the plug is accessible. Be sure to pull the plug off and close the water faucet in following cases: power failure, delivering the machine, setting the machine idle or cleaning the machine. Do not plug or pull the power plug with wet hand.



- Do not bend, extend, twist, bind by force. Do not press or nip it with weight.
- Keep the pin of the power plug clean, if the power plug is polluted with dust, please wipe with dry cloth carefully.
- If the power cord or the power plug is bad, to avoid risk it is required to have it replaced by the technicians of our special shop or our customer care agent.



In case the washing machine is installed on ground with carpet, do not block the ventilation hole with carpet.

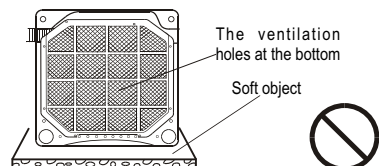

Do not use water hotter than 50°C.



Do not put the machine at damp place like the bathroom. Never wash it with water. Do not put wet laundries on the control panel.

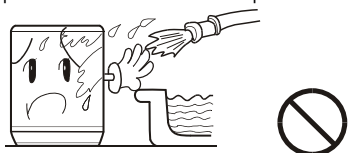

Do not wash water-proof laundries like the raincoat, bike covers etc. to avoid abnormal vibrations in spinning.



Do not let the machine share one receptacle with other electric appliances. If the plugging into the receptacle is loose, do not use the plug any more.

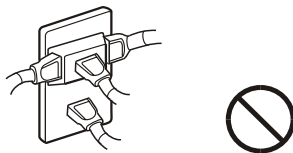

Trouble-shooting answer to question

(If there's breakdown, please pull off the power plug before checking) The following phenomena are not breakdowns sometimes. Please confirm again before sending it to repair. Do not repair it by yourself.

Phenomena	The reason	How to settle	
Buzzing upon reservation starts, the digitron displays "E0"	<ul style="list-style-type: none"> ● The top lid is not closed 	<ul style="list-style-type: none"> ● Close the top lid 	
No or slow drain, the digitron displays "E1", buzzing.	<ul style="list-style-type: none"> ● Is the drain hose put down? ● Is the drain hose blocked by foreign material? 	<ul style="list-style-type: none"> ● Put down the drain hose. Open and close the top lid once. ● Clean the foreign material. Open and close the top lid once. 	
Running pauses during spin, the digitron displays "E2", buzzing	<ul style="list-style-type: none"> ● The top cover leaves open 	<ul style="list-style-type: none"> ● Close the top lid 	
Safety switch actuates, not spin, (after self-correction twice), the digitron displays "E3", buzzing	<ul style="list-style-type: none"> ● Are the laundries put slantingly? ● Is the machine slanting? 	<ul style="list-style-type: none"> ● Re-order the laundries. Close the top lid. Level the machine in right position. ● Open and close the top lid once. 	
No or slow water filling (not reaching the level in 40 min), the digitron displays "E4", buzzing	<ul style="list-style-type: none"> ● The water tap is not open ● The water inlet valve is blocked ● The water pressure is too low and the current is too small 	<ul style="list-style-type: none"> ● Open the water tap. Push the "Start/Pause" button. ● Clean the water inlet valve. Push the "Start/Pause" button. ● Wait for the normal water pressure before use. 	
The digitron displays E6.	<ul style="list-style-type: none"> ● The water level sensor is bad. 	<ul style="list-style-type: none"> ● Please contact the after-sales service department. 	
Poor or no waterfall flow	<ul style="list-style-type: none"> ● If the nozzle is choked with foreign bodies 	<ul style="list-style-type: none"> ● Remove the foreign bodies 	
The machine does not act	Not wash	<ul style="list-style-type: none"> ● Is there power failure? ● Is the power plug loose? ● Does the water level arrive at the set water level? 	<ul style="list-style-type: none"> ● Use it when the power is on. ● Insert the power plug tightly. ● Affusion to the set water level.
	Not spin	<ul style="list-style-type: none"> ● Is the power plug loose? ● Is the top lid closed? ● Are the laundries put orderly? 	<ul style="list-style-type: none"> ● Insert the power plug tightly. ● Close the top lid ● Put the laundries orderly.
There's abnormal sound inside the machine	<ul style="list-style-type: none"> ● Is the machine slanting? ● Are the laundries slanting in spinning? 	<ul style="list-style-type: none"> ● Level the machine properly. ● Re-order the laundries. 	
The water faucet leaks	<ul style="list-style-type: none"> ● Is the jointer screw of the water inlet hose is loose or twisted awry? 	<ul style="list-style-type: none"> ● Fasten the jointer screw properly. 	

Common phenomena

Phenomena	Explanation
<ul style="list-style-type: none"> ● The spinning is intermittent when it starts. 	<ul style="list-style-type: none"> ● Balance the laundries to avoid slanting.
<ul style="list-style-type: none"> ● The wash procedure pauses. 	<ul style="list-style-type: none"> ● The cloth sensor is detecting, it will add water after about 48 seconds.
<ul style="list-style-type: none"> ● Select spin program, but it does not work. 	<ul style="list-style-type: none"> ● The program is setting the drain time, certain period is needed before it starts spinning.
<ul style="list-style-type: none"> ● There may be some water flowing out of the drain hose in the first use of the machine. 	<ul style="list-style-type: none"> ● It is the water remained performance inspection by the factory.

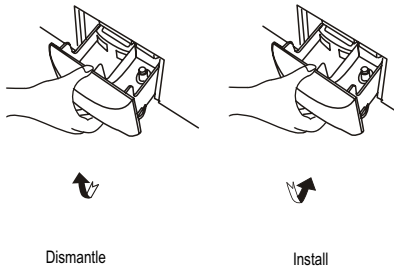
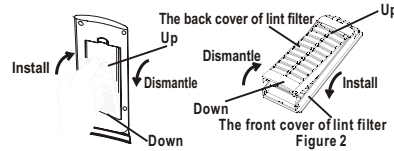
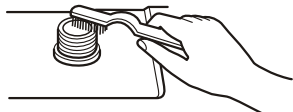
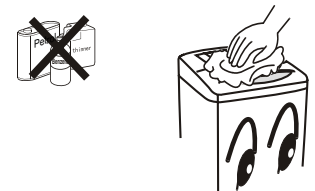

Disposal after washing

- After using, please clean the lint and foreign materials of the lint filter etc. in time. Otherwise it may influence your using the machine.
- Please first pull off the power plug from the receptacle before cleaning.

<p>Clean the detergent box and set it on the control panel seat.</p> <p>1.The method of dismantle: Push it up aslant and gently.</p> <p>2.The method of install : install it upwards and aslant and push it in .</p> 	<ul style="list-style-type: none"> • The lint filter must be used during washing. • It must be cleaned in time after each using. <p>Lint filter:</p> <ol style="list-style-type: none"> 1.Push down the spring piece of the top lint filter to make the claws out of the filter cover, and then pull out the lint filter to get it down. (figure1) 2.Pull the back of the lint filter, and then you can get down it off the front cover of the lint filter. (figure2) 3.Sweep the rubbish in the lint filter. 4.Put the back of the lint filter into the front cover . 5.Put the lint filter into filter cover, and make it tight . 6.Make sure the lint filter well installed, or it can influence your use.  <p>Figure 1</p>
<p>The filter screen of the water inlet valve is likely to be blocked by foreign materials and influence the water inlet. Please clean it with brush every two months.</p> 	<p>If the cabinet is dirty, wipe it with wet cloth</p> <ul style="list-style-type: none"> • Do not flush it directly with water. • Wipe it with neutral detergent. • Do not wipe it with thinner, petrol, alcohol etc. 

- 1.After washing, close the water faucet. (If needed, you can dismantle the water inlet hose).
- 2.Do not store water in the washing machine for a long period. Drain the water completely after each using.
- 3.Be sure to pull off the power plug before maintenance.
- 4.Hang up the power cord and drain hose.
- 5.Wipe off the water drops on the surface of the machine and inside the tub. Open the top lid for some time (about 1 hour), then close the top lid.

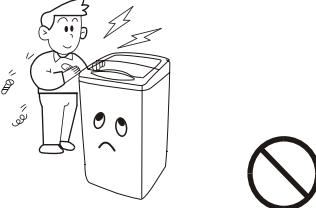
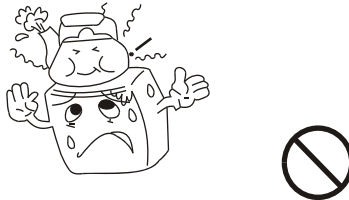
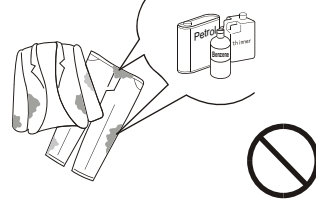
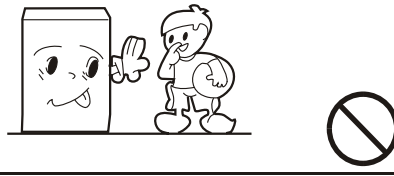
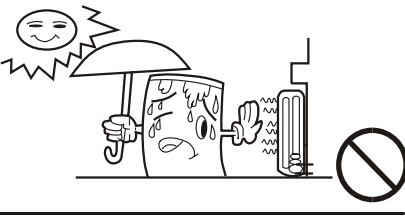
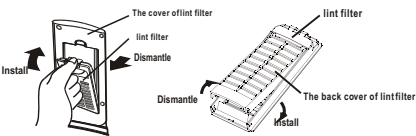
Safety precautions

<p>Do not put hand into the rotating tub. It is dangerous even if the rotation speed is slow. Take special care of the children. Keep children away from the washing machine to avoid them climbing on.</p> 	<p>Do not decompose, repair or alter the machine by yourself.</p> 
<p>Do not put any hot or heavy items (such as the kettle with hot water) on the washing machine.</p> 	<p>Do not wash laundries with volatile materials (such as thinner, petrol etc.).</p> 
<p>The handicapped or children without care shall not use the machine.</p> 	<p>Keep the machine away from direct sunlight and heat source like the heater.</p> 
<p>Please keep the lint filter in good condition, and install it to proper position during washing. If the lint filter is lost or damaged, please contact the local customer care agent.</p> 	<ul style="list-style-type: none"> • To protect your laundries and washing machine, please take out all of the coins, buttons, sand, hairpin and other foreign materials before washing. • Please check if the water faucet is open, and if the connection of the water inlet pipe is proper. • It is suggested to use foamless washing powder. 

Installation and adjustment

Please install and adjust the machine according to the requirement of the manual. It is very important to your security and correct operating the machine.

Install the bottom plate

After you open the package, please lean the washing machine gently down on soft items (like the towel cloth, blanket, etc.). Install the bottom plate to the bottom of the machine with the eight screws by a cross screwdriver, then lift the machine up gently. See to the figure:

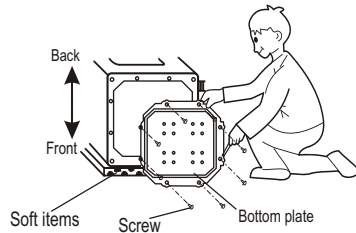

Adjust the Installation position

The largest allowable slope of the shank base of the machine is 2°. The slanting or rough ground will result in unstable running or stoppage of the machine. Please adjust it with following methods:

- Confirm it's horizontal:
Hang the lead line to check if it is horizontal.

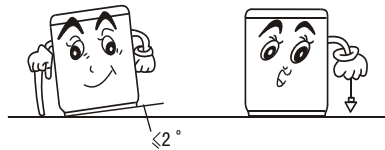

- Adjust the adjustable leg:

1. To twist the adjustable leg, please first lift up the side of the leg slightly, loosen the adjustable nut, and twist the leg.

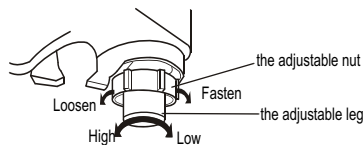

2. After adjustment, fasten the nut.

4 Push the "water level" button, select suitable water level



After switching on the power, the washing machine will execute fuzzy program automatically to detect the cloth. After defection, it can set the water level automatically. To select other water level, first push the "start/pause" button, then push the "water level" button to set the water level.

5 Push the "reserve" button to select suitable reserve wash program



After switching on the power, the reserve program is set to off mode automatically. If you need to set the washing procedure to be finished at reserved time, please push the "reserve" button to set the reserve wash program. Refer to reserve button in Page 10 for selection.

- Confirm the operation of reserve program



- When the "reserve" function is activated, the indicator light of the program you have set will be off. The "reserve (hour)" and "time remain" indicator lights will be on. During reserve procedure, push the "reserve" button to display the reserve mode.
- To change the running program or cancel the reserve setting, you need to switch off the power and make new selection.



the washing will be finished after 18 hours

6 Push the "Air dry" button



Attention:

- After switching on the power, the function of the "Air dry" and "reserve" is not selected at the same time.
- Only after the program with the spin is set, "Air dry" program can be selected; selecting the other program without spinning, "Air dry" program can not be selected that is the button of "Air dry" is no reaction.

7 Push the "Start/Pause" button



6 Finish washing

After finishing wash, it'll alarm automatically

b Steps of using the operation buttons and description of the steps

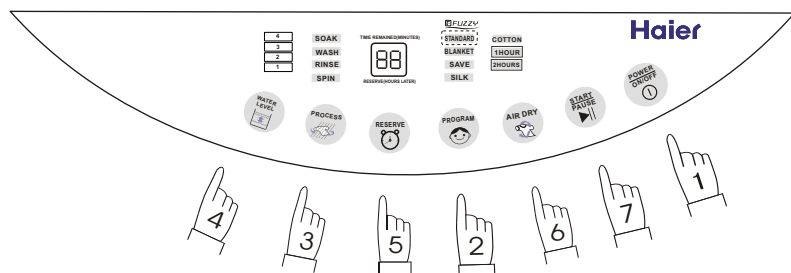

1. Push "power" button to switch on the power



2. Push "program" button to select suitable full-auto program



After the power is switched on, "standard" is automatically set. To select other full-auto program, please push the "program" button till the corresponding indicator is on. Refer to the "Program button" on Page 11. E.g. Set to "SAVE" program for small quantity of laundries with light soil.

P11

3 Push "Process" button to select suitable procedure program



Attention

P10

- Even there's no water in the tub, a certain period is required before spin starting.
- Separate the laundries that are not colorfast from other laundries in washing.
- The soak procedure can work in cooperation with automatic programs like standard, blanket cotton. There is intermittent pulsator stirring during soak.
- After the machine starts operation, you can only set the program and procedure during washing, and can not make setting in other cases.

How to change the direction of the drain hose

1. Dismantle the rear cover of the washing machine.
2. Put down the drain hose. Take off the drain hose frame as indicated in Figure 1. Take the drain hose into the cabinet, then nip the drain fixing clamp to make it deviated from the clip, the other hand is used to put down the drain bushing, as indicated in Figure 2, 3.
3. Dismantle the drain outlet protecting cover at the other side, (the way is the same as the drain bushing), then install the drain bushing, as indicated in Figure 4.
4. Extend the drain hose from the other side. Fix the drain hose with drain hose frame onto the cabinet, as indicated in Figure 5.
5. Install the drain outlet protecting cover to the other side, as indicated in Figure 6.

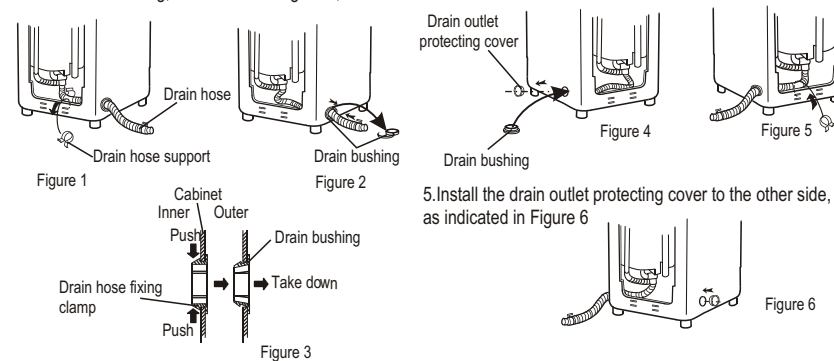

Remarks: in order to make sure of the correct of installation, it is suggested to change the direction of the drain hose with our company serviceman.

Usage the drain hose

The drainage shall be smooth with the drain hose.

1. The height of the drain hose shall be less than 10cm, or the drainage will not be smooth, and cost such long time that the machine may stop at mid way.
2. Do not step on or press the drain hose.
3. If the drain hose is too long, cut it at mid point. To make smooth drainage, cut the front end of the hose slantingly.
4. If extra drain hose is needed, please make separate purchase. The inner diameter of the extra hose shall not less than 30mm, and the length shall not exceed 1.5m.
5. If the extra hose is too long, cut it either at A or at B.

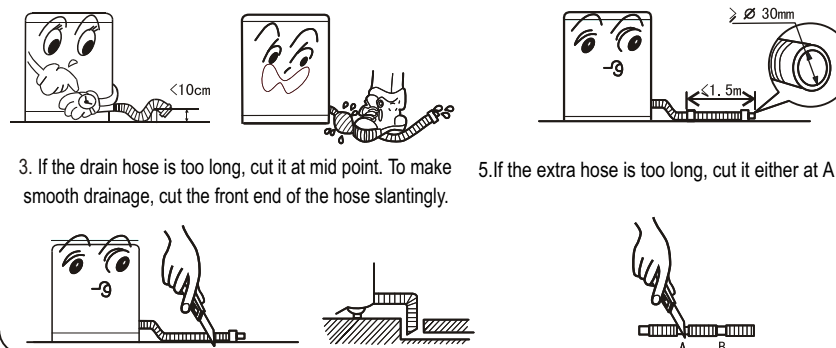

Install the water inlet hose

Confirm the water faucet

Water faucet, suitable

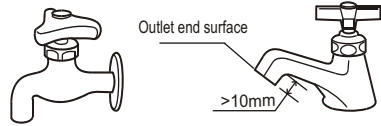

It is required that the front end shall be longer than 10mm.
The exit end face of the faucet shall be flat and smooth. If not please file it to avoid leakage.

Water faucet, not suitable

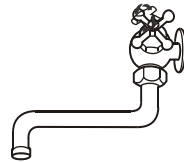

Connection between the water inlet hose jointer and the water faucet

1. Press the lower end of the lock lever and push down the slider. Take off the water inlet hose jointer from the water inlet hose component. See to Figure 1.
2. Loosen the screw till the water faucet can be accessed. Put the jointer of the water inlet hose on the faucet. See to Figure 2. (If the faucet is too large and the jointer can not be set on the water faucet, please loosen the four screws and take out the bushing in the jointer. The front end of the faucet must be smooth, otherwise it may leak water. See to Figure 3.)

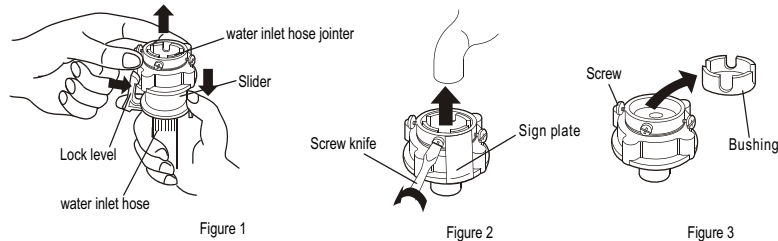

3. Fasten the four screws evenly. See to Figure 4.
4. Take off the nameplate. Twist the fastening nut as per the indication of the figure to seal up the exit end face of the faucet. See to Figure 5.

remark: Before installation, the threading is 4mm above the upper surface of the nut.
After installation, the threading is 2mm above the upper surface of the nut. See to figure 6.

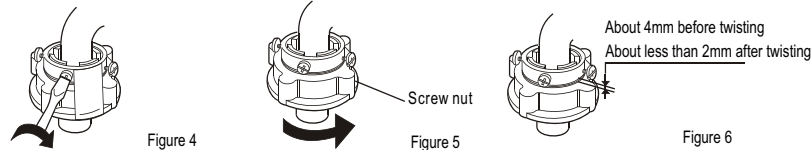

"Start/pause" button

- After the power is switched on, press it to start the machine
- During working, push it to pause.
 - During pause, push this button to restart and go on working

"Power" button

- Push the "power" button to switch on the power.
- Under power-on mode, push it to switch off the power.
- Push the "power" button to switch on the power. If the "start/pause" button is not pushed, the machine will switch off the power automatically after 5 minutes.

FUZZY

STANDARD

BLANKET

SAVE

SILK

COTTON

1 HOUR

2 HOURS



"Program" button

Following full-auto program is available

Program	Application
Standard	Common washing
Blanket	Washing for coverlet, bigger, heavy thickness laundries
Save	Washing for the normal laundries in short time
Silk	Washing for silk textiles
Cotton	Washing for cotton textiles

"AIR-DRY" button

Push the "AIR-DRY" button, then the "AIR-DRY" indicator light is on, that means the "AIR-DRY" program is chosen. The purpose is drying the inner tub and the outer tub, which can avoid growing mildew on the outer tub and the inner tub.

5 Use the operation buttons

a Description of operation button

Indicator mode and meaning

- Off:
- :○: Flashing: indicate the running program
- On: indicate the program about to run, or indicate the selected mode

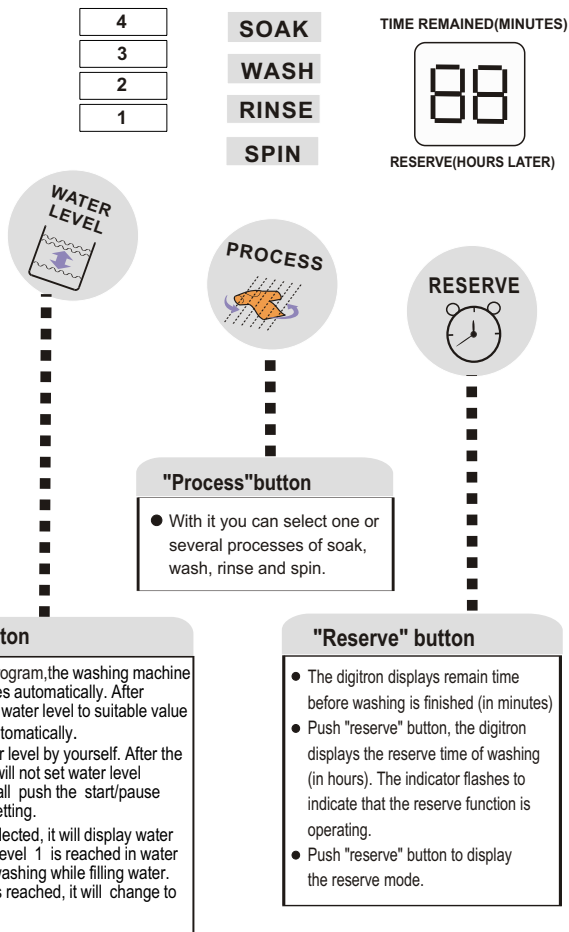

Connection between the water inlet hose and the washer

1. Do not take off the water absorption cushion. Please check if the cushion is dropped or damaged before each usage. If it happens, please contact our after-sale department immediately.
2. Put the nut of the water inlet hose on the valve jointer.
3. Fasten the nut. Swing it gently to confirm if it's suitable.

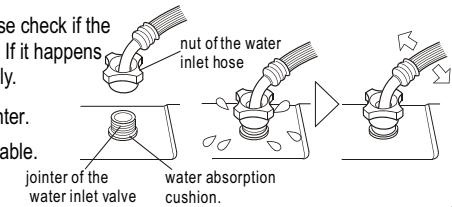

Connection between the jointer of the water inlet hose and the water inlet hose

1. Push down the slider. Insert the water inlet hose into the jointer.
2. Hang the lock lever to the jointer. Release the slider till a click sound is heard.

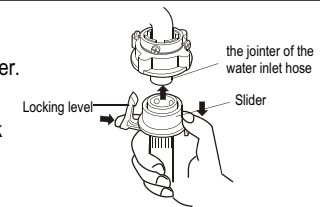

Check the connection between the jointer of the water inlet hose and the water faucet

1. Swing the hose gently to confirm if it is fastened stable.
2. After installation, open the faucet to check if it leaks.
3. Do not bend the hose with overstrain.
4. Before each usage please check if the connection between the jointer of the water inlet hose and the water faucet, and the installation of the water inlet hose are firm, so as to prevent dropping from improper installation position.

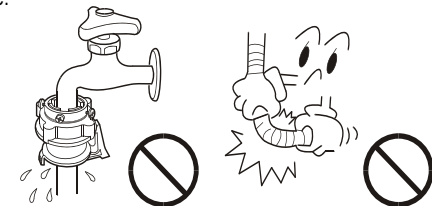

Dismantle the water inlet hose

1. Close the water faucet.
2. Press the locking lever. Push down the slider. Then pull of the water inlet hose.

If the machine is used frequently, the jointer of the water inlet hose can be kept on the faucet to prevent damaging the fixing screw.

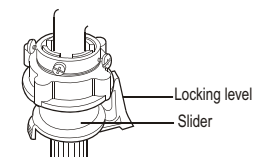

1.Preparation before washing





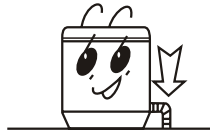

Preparation before washing

- 1.Connect the water inlet hose
- 2.Confirm that the washing machine is earthed reliably. Then insert the power plug into the receptacle. Do not connect the earth terminal to the gas pipe and tap water pipe.
- 3.Put down the drain hose



- 4.Slanting or uneven ground may result in unstable working or abnormal noise. Please make the machine stand horizontally.

Pay attention to followings before washing the laundries

<p>Confirm if there's special requirement for the laundries.</p>	<p>Clear the pocket. Take out the coins, sand, hairpins etc.</p> 	<p>Fasten the buttons and zippers.</p> 	<p>The quantity of the laundries shall not exceed the rated value. The big laundries like the jeans shall be put in loosely.</p> 	<p>When the pulsator is running, the buttons of the laundries may cause noise. For the sake of discretion, please put the laundries with buttons into other laundries.</p> 
<p>a. Check if the laundries are applicable for washing with machine. b. Divide the laundries that are not colorfast from other laundries. c. Put those laundries difficult to absorb water into water with hand. d. For those laundries with heavy soil, please first remove the dirt like mud or dust. For the parts with heavy soil, please apply detergent in advance, which can make it easier to remove the soil. e. For those laundries that may get lint ball and those with long fur, turn it over before putting in. f. Do not put those laundries polluted by chemicals directly into the washing machine. For those small laundries and those may get twisting or worn, and woolen/fur laundries, please put them into mesh bag for washing.</p>				

2.Put in the laundries



- The capacity of washing of the machine refer to the largest weight of the standard laundries under dry condition that can be washed in one time. Laundries quantity in one washing cycle shall be lower than the rated capacity.
- The thickness, size, type of the cloth will influence the actual washing capacity.
- It is suitable to put in reasonable amount of laundries and the laundries can be turned round in washing for one time washing.

3. Usage of detergent

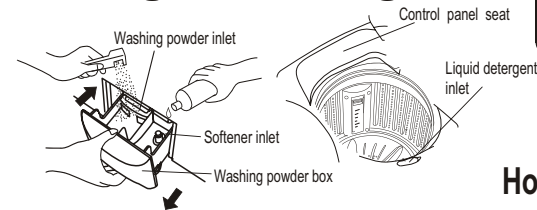

- Add washing powder and softener into the box directly as per indicated in left figure.
- After adding, close the box.

How to use washing powder

- It is suggested to add washing powder into the box directly under fuzzy program and reserve program.
- Dissolve directly inside the washing machine: (not applicable for fuzzy and reserve program)
 - 1.Add some water(select the "1" water level)
 - 2.Add washing powder. Run for about 30s to fully dissolve the Powder. Then push the "start/pause" button.
 - 3.Put in laundries. Select suitable water level. Push the "start/pause" button again.
- Quick dissolving of washing powder:
 1. Prepare warm water of 30°C and container.
 2. Add washing powder while stirring to dissolve it completely.
- Please add suitable washing powder as per the laundries quantity, the set water level and water quantity.
- If you select save program, it is suggested to use liquid detergent instead of washing powder to guarantee the washing effect.
- It is not recommended to use rich-foam washing powder.
- Washing powder with poor quality or long-time storage may get caked. Please clean the detergent box duly in usage.

How to use softener

- See to the manual of softener for the usage and dosage.
- When adding softener into the softener inlet of washing powder box, note that it shall not exceed the lower side of the cap.
- Do not leave the softener for long period after adding it into the box. Otherwise it may be solidified and block the inlet.
- As the softener is easy to solidify, please clean the box frequently.(You shall clean it each time you use reserve function).
Before use softener, you must select to sterilize function

How to use whitener

- Add water to stipulated level. Dilute the whitener with container, and then pour it into the liquid whitener inlet slowly.
- Laundries with color or pattern is not colorfast, thus not applicable.
- The whitener shall not touch laundries directly.
- See to the manual of whitener for the usage and dosage.
- For whitener in powder, dissolve it before use.

4. Close the top lid

If you open the top lid, the machine will stop working and alarm in spinning process.

Free Manuals Download Website

<http://myh66.com>

<http://usermanuals.us>

<http://www.somanuals.com>

<http://www.4manuals.cc>

<http://www.manual-lib.com>

<http://www.404manual.com>

<http://www.luxmanual.com>

<http://aubethermostatmanual.com>

Golf course search by state

<http://golfingnear.com>

Email search by domain

<http://emailbydomain.com>

Auto manuals search

<http://auto.somanuals.com>

TV manuals search

<http://tv.somanuals.com>