

Full Automatic Washing Machine

User's manual



**This manual is for
HWM90-96A**

0030807216

- Please read this manual carefully before using.
- Retain it for future reference.



CONTENTS

- Names of the parts····· 1
- Safety precautions····· 2
- Installation and adjustment····· 3
- Install the water inlet hose····· 5
- Preparation before using····· 7
- Put in the laundries····· 8
- Usage of the detergent····· 9
- Use the operation buttons····· 10
- Close the top lid····· 14
- Finish washing····· 14
- Disposal after washing····· 15
- Trouble shooting answer to question····· 16
- Packing list····· 17
- Specification table····· 17

Packing list

Name	Quantity	Storage position
● User's manual	● One	● Inside the document bag
● Warranty card	● One	● Inside the document bag
● Components of the water inlet hose	● One	● Inside the accessory bag
● Tapping screws	● Eight	● Inside the accessory bag
● Computerized Automatic washing machine	● One	
● Bottom plate	● One	● Between the upper cushion of the washing machine package and the upper seal of the package carton

Specification table

Model	HWM90-96A
Rated voltage • frequency	220V-240V ~ • 50Hz
Standard Rated washing / spinning capacity	7.0kg
Largest Rated washing / spinning capacity	9.0kg
Water level/Water quantity (about)	1/23L、2/28L、3/32L、4/37L、5/41L 6/45L、7/50L、8/56L、9/63L、10/68L
Max water consumption	About 160L (Highest water level; Standard program)
Water Injection pressure	0.03MPa~0.78MPa
Rated washing input power	380W
Rated spinning input power	300W
Weight	About 39kg

Trouble-shooting answer to question

(If there's breakdown, please pull off the power plug before checking) The following phenomena are not breakdowns sometimes. Please confirm again before sending it to repair. If there are real breakdowns, please come to the special maintenance department or after-sale service department of our company. Do not repair it by yourself.

Phenomena	The reason	How to settle	
Buzzing upon reservation starts, Nixie tube indicates "E0"	<ul style="list-style-type: none"> The top lid is not closed 	<ul style="list-style-type: none"> Close the top lid 	
No or slow drain, nixie tube indicates "E1", buzzing.	<ul style="list-style-type: none"> Is the drain hose put down? Is the drain hose blocked by foreign material? 	<ul style="list-style-type: none"> Put down the drain hose. Open and close the top lid once. Clean the foreign material. Open and close the top lid once. 	
Running pauses during spin, nixie tube indicates "E2", buzzing	<ul style="list-style-type: none"> The top cover leaves open 	<ul style="list-style-type: none"> Close the top lid 	
Safety switch actuates, not spin, (after self-correction twice), nixie tube displays "E3", buzzing	<ul style="list-style-type: none"> Are the laundries put slantingly? Is the machine slanting? 	<ul style="list-style-type: none"> Re-order the laundries. Close the top lid. Level the machine in right position. Open and close the top lid once. 	
No or slow water filling (not reaching the level in 40 min), nixie tube indicates "E4", buzzing	<ul style="list-style-type: none"> The water tap is not open The water inlet valve is blocked The water pressure is too low and the current is too small 	<ul style="list-style-type: none"> Open the water tap. Push the "Start/Pause" button. Clean the water inlet valve. Push the "Start/Pause" button. Wait for the normal water pressure before use. 	
The digitron displays E6.	<ul style="list-style-type: none"> The water level sensor is bad. 	<ul style="list-style-type: none"> Please contact the after-sales service department. 	
Poor or no waterfall flow	<ul style="list-style-type: none"> If the nozzle is choked with foreign bodies 	<ul style="list-style-type: none"> Remove the foreign bodies 	
The machine does not act	Not wash	<ul style="list-style-type: none"> Is there power failure? Is the power plug loose? Does the water level arrive at the set water level? 	<ul style="list-style-type: none"> Use it when the power is on. Insert the power plug tightly. Affusion to the set water level.
	Not spin	<ul style="list-style-type: none"> Is the power plug loose? Is the top lid closed? Are the laundries put orderly? 	<ul style="list-style-type: none"> Insert the power plug tightly. Close the top lid Put the laundries orderly.
There's abnormal sound inside the machine	<ul style="list-style-type: none"> Is the machine slanting? Are the laundries slanting in spinning? 	<ul style="list-style-type: none"> Level the machine properly. Re-order the laundries. 	
The water faucet leaks	<ul style="list-style-type: none"> Is the jointer screw of the water inlet hose is loose or twisted awry? 	<ul style="list-style-type: none"> Fasten the jointer screw properly. 	

Common phenomena

Phenomena	Explanation
<ul style="list-style-type: none"> The spinning is intermittent when it starts. 	<ul style="list-style-type: none"> Balance the laundries to avoid slanting.
<ul style="list-style-type: none"> The wash procedure pauses. 	<ul style="list-style-type: none"> The cloth sensor is detecting, it will add water after about 48 seconds.
<ul style="list-style-type: none"> Select spin program, but it does not work. 	<ul style="list-style-type: none"> The program is setting the drain time, certain period is needed before it starts spinning.
<ul style="list-style-type: none"> There may be some water flowing out of the drain hose in the first use of the machine. 	<ul style="list-style-type: none"> It is the water remained performance inspection by the factory.

Names of the parts

Before Using

Honourable users:

Thank you for choosing our products.

Our products integrate high-tech, precision, frontier science. To facilitate using it, please read this manual carefully and operate this machine according to it.

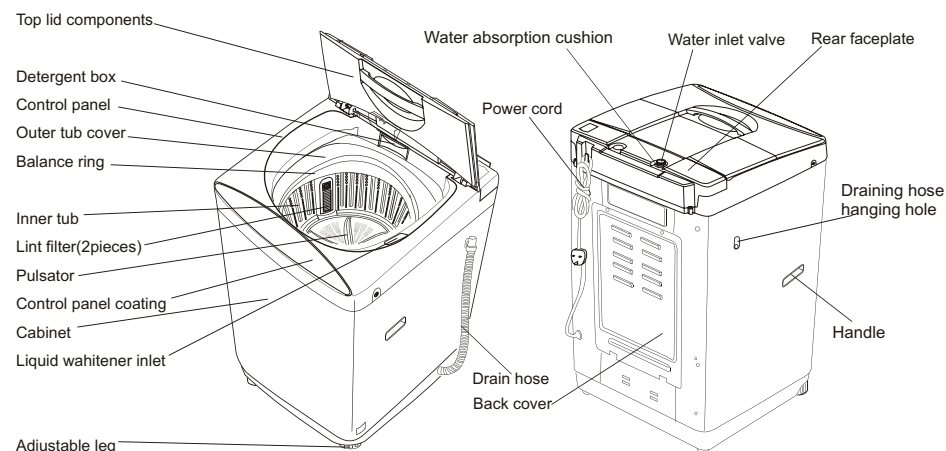

Accessories

	Bottom plate (One piece)
	Water inlet hose (One piece)
	Water inlet hose jointer (One piece)
	Tapping screw (Eight pieces)

Meaning and description of the symbols

	Contents marked with that symbol are related to the safety of the product and the personal safety of the users. Please operate in strict conformity to the contents, otherwise it may result in damage of the machine or influence the personal safety of the users.
	Contents marked with that symbol are actions forbidden to perform. Performing of those actions may result in damage of the machine or influence the personal safety of the users.

The figure in this manual being sketch map and with the improvement of our products, the machine you buy is like to be different from the figure indicated in the manual. Please understand.

Safety precautions

Before Using

Please plug the power plug on special receptacle. Be sure to use three-pins power receptacle. Ensure that the earthing prong of the power receptacle is earthed reliably. Use leakage protector if possible.

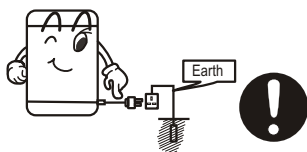

The washing machine must be positioned so that the plug is accessible. Be sure to pull the plug off and close the water faucet in following cases: power failure, delivering the machine, setting the machine idle or cleaning the machine. Do not plug or pull the power plug with wet hand.



- Do not bend, extend, twist, bind by force. Do not press or nip it with weight.
- Keep the pin of the power plug clean, if the power plug is polluted with dust, please wipe with dry cloth carefully.
- If the power cord or the power plug is bad, to avoid risk it is required to have it replaced by the technicians of our special shop or the after-sale service department.



In case the washing machine is installed on ground with carpet, do not block the ventilation hole with carpet.

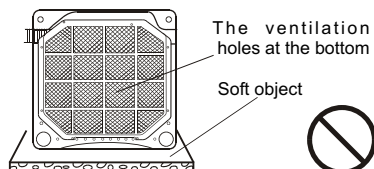

Do not use water hotter than 50°C.



Do not put the machine at damp place like the bathroom. Never wash it with water. Do not put wet laundries on the control panel.

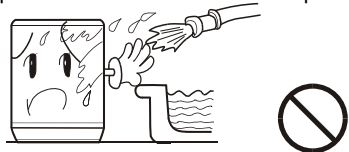

Do not wash water-proof laundries like the raincoat, bike covers etc. to avoid abnormal vibrations in spinning.



Do not let the machine share one receptacle with other electric appliances. If the plugging into the receptacle is loose, do not use the plug any more.

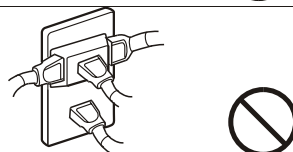

Please keep the lint filter in good condition, and install it to proper position during washing. If the lint filter is lost or damaged, please contact the local after-sales service department of our company.

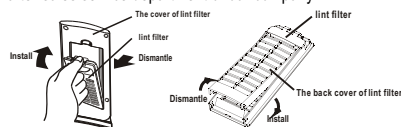

To prevent your laundries and washing machine from damages, be sure to take out all of the foreign materials from your pocket, such as coins, buttons, sandor hair pins etc.



- Before washing, please check if the water tap is open, and if the water inlet pipe is connected properly.
- It is suggested to use low-foaming washing powder.

7 Disposal after washing Using process

- After using, please clean the lint and foreign materials of the lint filter etc. in time. Otherwise it may influence your using the machine.
- Please first pull off the power plug from the receptacle before cleaning.

Clean the detergent box and set it on the control panel seat.

- The method of dismantle : Push it up aslant and gently.
- The method of install : install it upwards and aslant and push it in .

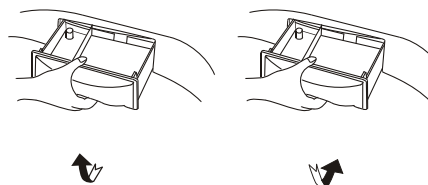

Dismantle

Install

Please keep the lint filter in good condition, and install it to proper position during washing. If the lint filter is lost or damaged, please contact the local after-sales service department of our company.

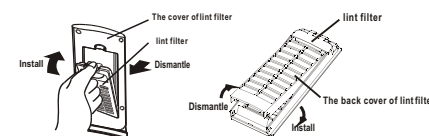

The filter screen of the water inlet valve is likely to be blocked by foreign materials and influence the water inlet. Please clean it with brush every two months.

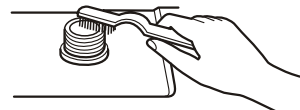

If the cabinet is dirty, wipe it with wet cloth

- Do not flush it directly with water.
- Wipe it with neutral detergent.
- Do not wipe it with thinner, petrol, alcohol etc.



1. After washing, close the water faucet. (If needed, you can dismantle the water inlet hose).

2. Do not store water in the washing machine for a long period. Drain the water completely after each using.

3. Be sure to pull off the power plug before maintenance.

4. Hang up the power cord and drain hose.

5. Wipe off the water drops on the surface of the machine and inside the tub. Open the top lid for some time (about 1 hour), then close the top lid.

Using process

- * Total time: including the normal water inlet time and drain time. The total washing time may be influenced by the water inlet pressure and water level.
- * Spin time: From the moment the intermittent spinning starts to the moment it stops running (the time displayed on spin digitron is from intermittent spinning to the moment before inertia spinning; the time displayed on the time remain digitron is the total remained time)
- * During saving water program, if the water inlet pressure is lower, the machine will come into rinse with water.
- * When selecting soak procedure, it will first soak for 10~40 minutes, then do washing, rinsing and spinning.

5 Push the "reserve" button to select suitable reserve wash program

RESERVE

After switching on the power, the reserve program is set to off mode automatically. If you need to set the washing procedure to be finished at reserved time, please push the "RESERVE" button to set the reserve wash program. Refer to RESERVE button in Page 11 for selection.

Page 11 

TIME REMAINED(MINUTE)



RESERVE(HOURS LATER)

6 Push the "START/PAUSE" button

START
PAUSE

Attention

- After the program starts running, the buttons are not selected excepted the water level and start/pause button
- If you open the top lid during the running program, The digitron displays E2

5 Close the top lid

As the top lid opened, the Washer will automatically give an alarm and stop running, exclusively during supplying water and rinsing.

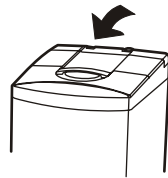

6 Finish washing

After finishing wash, it'll switch off the power automatically.



Safety precautions

Before Using

Do not stretch hands into the working machine. It is dangerous even if the rotation is slow. Take special care of the children.



Do not decompose, repair or alter the machine by yourself.



Do not put any hot or heavy items (such as the kettle with hot water) on the washing machine



Do not wash laundries with volatile materials (such as thinner, petrol etc.).

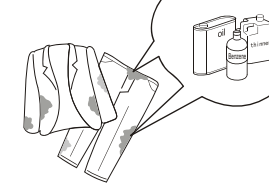

The appliance is not instruct for use of young children of infirm persons without supervision. Young children should be supervised to ensure that they do not play with the appliance.

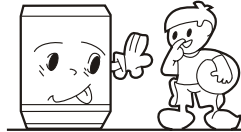

Keep the machine away from direct sunlight and heat source like the heater.

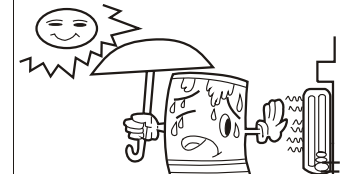

Installation and adjustment

Please install and adjust the machine according to the requirement of the manual. It is very important to your security and correct operating the machine.

Install the bottom plate

After opening the package, please lean the washing machine gently down on soft items (like towel cloth, blanket, etc.). Install the bottom plate to the bottom of the machine with eight screws by a cross screwdriver, then lift the machine up gently. See to the figure:

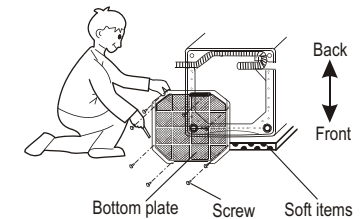

Adjust the Installation position

Before Using

The largest allowed slope of the shank base of the machine is 2°. The slanting or rough ground will result in unstable running or stoppage of the machine. Please adjust it with following methods:

- Confirm it's horizontal
Hang the plumb to confirm it's horizontal
- Adjust the adjustable foot
(1) To twist the adjustable foot at the right front of the cabinet (front the sight of front), please first lift up the side of the foot slightly, loosen the adjustable nut, and twist the foot.
(2) Fasten the nut after adjustment.

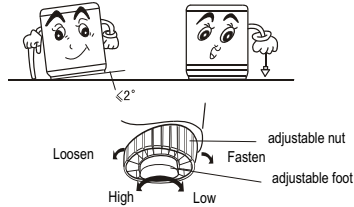

How to change the direction of the drain hose

1. Lean the machine down gently with the front surface facing the ground. Loosen the eight screws by a cross screwdriver.
3. Extend the drain hose from the right side. Push the drain hose into the groove with hands.

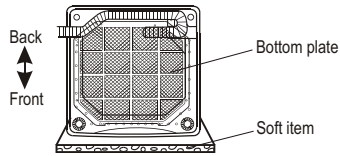

2. Pull out the drain hose from the groove at the left side.

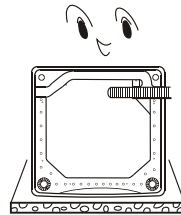
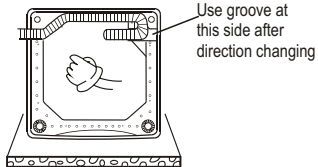

4. Install the bottom plate (as per indicated before), then lift the machine up gently.

Page 3

Usage of the drain hose

The drain hose shall drain smoothly

1. The height of the drain hose shall be less than 10cm, or the drainage will not be smooth, and cost such long time that the machine may stop at mid way.
2. Do not ramp or press the drain hose.
4. If extra drain hose is needed, please make separate purchase. The inner diameter of the extra hose shall not less than 30mm, and the length shall not exceed 1.5m.

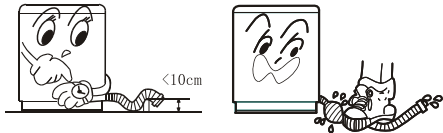

3. If the drain hose is too long, cut it at mid point. To make smooth drainage, cut the front end of the hose slantingly.



5. If the extra hose is too long, cut it either at A or at B point.

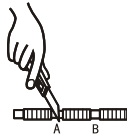

Using process

After switching on the power, the washing machine will set to standard program including "wash, rinse, spin" automatically. To select other procedures, push the "SOAK", "WASH", "RINSE" or "SPIN" button to select the time of soak, wash and spin, and the times of rinse. After switching on the power, if you push one of the button among "WASH", "RINSE" and "SPIN", the digitron of the former procedures will turn off automatically. The former procedures will not run. For instance: after switching on the power. If you push the "SPIN" button first, it will execute spin singly after starting.

Attention

- Even there's no water in the tub, a certain period is required before spin starting.
- Do not use the soak program for the woolen textiles.
- Separate the laundries that are not colorfast from other laundries in washing.
- The pulsator will not rotate unless the water is filled to water level 3.

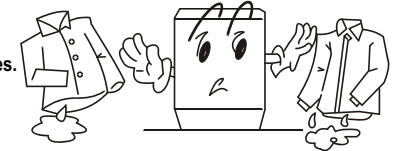

- After the machine starts operation, you can only set the program and procedure during washing, and can not make setting in other cases.
- The soak program can be used as fitting of common, carpeting, nomarl or cotton automatic programs. It will do soaking with intermittent stirring of pulsator.

4 Press "WATER LEVEL" button, select suitable water level



After switching on the power, the washing machine will execute fuzzy program automatically to detect the cloth. After defection, it can set the water level automatically. To select other water level, first push the "START/PAUSE" button, then push the "WATER LEVEL" button to set the water level. Refer to "water level, water quantity and desoge of powder" in Page 9 and "WATER LEVEL" button in Page 11 for selection.

Page 9

Page 11

Water Level and Time Table for Each Program (self programming not included)

Program	Wash(minutes)	Rinse(times)	Spin(minutes)	Total time(minutes)
Standard	About 12	Rinse twice, about 2 each time	About 4	About 30
Dry-cleaning	About 15	Rinse twice, about 5 each time	About 5	About 51
Save	About 3	Rinse once, about 3 each time	About 1	About 12
Blanket	About 15	Rinse twice, about 5 each time	About 5	About 72
Silk	About 5	Rinse twice, about 2 each time	About 2	About 30
Cotton	About 10	Rinse twice, about 3 each time	About 3	About 56
Woolen	About 6	Rinse twice, about 2 each time	About 1	About 37

Using process

b Steps of using the operation buttons and description of the steps

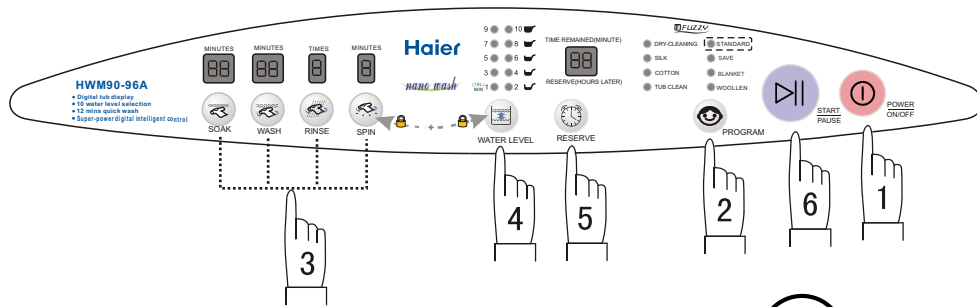

1 Push the "POWER ON/OFF" button to switch on the power.

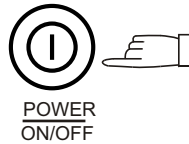

2 Push the "PROGRAM" button to select suitable automatic program.



After switching on the power, the machine will set standard program automatically. To select other automatic program, push the "program" button till the relative indicator is on. Refer to the "program button" on Page 11 for the selection.

For instance: select "SAVE" program for laundries with small quantity and light soil.

Page 11

FLUZZY

● In selecting the standard program, the machine will execute fuzzy program to select water and wash time according to the cloth and weight of the laundries. The full procedure is controlled automatically.



3 Push the "SOAK", "WASH", "RINSE" or "SPIN" button to select suitable procedure.

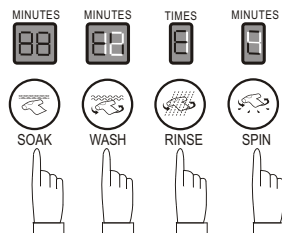

Install the water inlet hose Before Using

Confirm the water faucet

water faucet, suitable

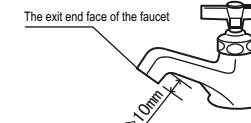

water faucet, not suitable

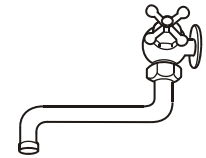

It is required that the front end shall be longer than 10mm.

The exit end face of the faucet shall be flat and smooth. If not please file it to avoid leakage.

Connection between the water inlet hose jointer and the water faucet

1. Press the lower end of the lock lever and push down the slider. Take off the water inlet hose jointer from the water inlet hose component. See to Figure 1.
2. Loosen the screw till the water faucet can be accessed. Put the jointer of the water inlet hose on the faucet. See to Figure 2. (If the faucet is too large and the jointer can not be set on the water faucet, please loosen the four screws and take out the bushing in the jointer. The front end of the faucet must be smooth, otherwise it may leak water. See to Figure 3.)

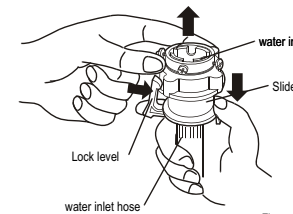

Figure 1

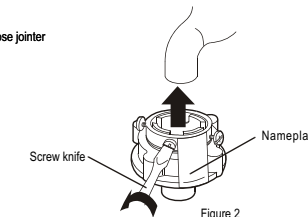

Figure 2

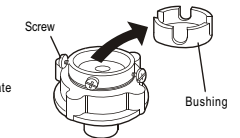

Figure 3

3. Fasten the four screws evenly. See to Figure 4.

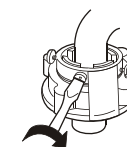

Figure 4

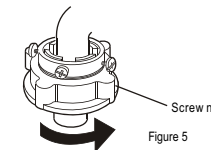

Figure 5

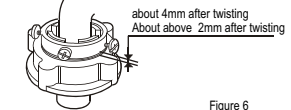

Figure 6

4. Take off the nameplate. Twist the fastening nut as per the indication of the figure to seal up the exit end face of the faucet. See to Figure 5.

Remark: Before twisting the fastening nut, the threading is 4mm above the upper surface of the nut. After twisting, the threading is less than 2mm above the upper surface of the nut. See to Figure 6

Before Using

Connection between the water inlet hose and the washer

1. Do not take off the water absorption cushion. Please check if the cushion is dropped or damaged before each usage. If it happens please contact our after-sale department immediately.

2. Put the nut of the water inlet hose on the valve jointer.

3. Fasten the nut. Swing it gently to confirm if it's suitable.

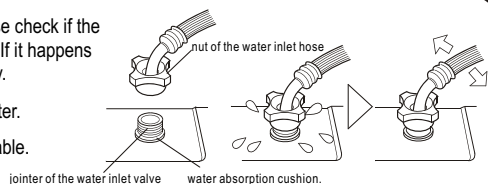

Connection between the jointer of the water inlet hose and the water inlet hose

1. Push down the slider. Insert the water inlet hose into the jointer.

2. Hang the lock lever to the jointer. Release the slider till a click sound is heard.

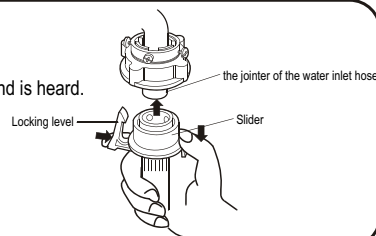

Check the connection between the jointer of the water inlet hose and the water faucet

1. Swing the hose gently to confirm if it is fastened stable.

2. After installation, open the faucet to check if it leaks.

3. Do not bend the hose with overstrain.

4. Before each usage please check if the connection between the jointer of the water inlet hose and the water faucet, and the installation of the water inlet hose are firm, so as to prevent dropping from improper installation position.

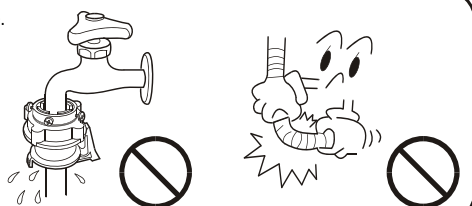

Dismantle the water inlet hose

1. Close the water faucet.

2. Press the locking lever. Push down the slider. Then pull of the water inlet hose. If the machine is used frequently, the jointer of the water inlet hose can be kept on the faucet to prevent damaging the fixing screw.

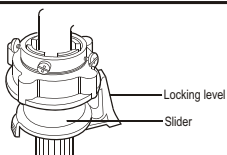

Remarks: use the new hose sets supplied with the washer.

Any other old hose sets should not be used.

Using process

Child lock function

- This function is used to protect the children and prevent them from changing the washing procedure.
- Start up: The program is optional anytime after the machine has been started. Push and hold the WATER LEVEL button and SPIN button for more than 3 seconds at the same time. After a beep sound, the child safety lock program works; all buttons are locked and cannot be selected. During this period, when open the top lid, the machine will give a beep alarm. 15 seconds later, no matter opening or closing the top lid, the machine goes on alarming and drains water. After draining, 10 minutes later power off automatically.
- Release: push and hold WATER LEVEL button and SPIN button for more than 3 seconds at the same time. After a beep sound, the child safety lock program is released; all buttons are unlocked.

Reserve/remain time indicator digitron

- During sensing, it displays "--"
- During reserve procedure, it displays the remained reserve time (in hour)
- During operation of programs, it displays the remained time (minute). If the remained time exceeds 99 minutes, it adopts A at tens place to represent 100 minutes, b to represent 110 minutes. For instance, A3 represents 103 minutes.
- In case of abnormal phenomenon, it displays the abnormal symbol (see to Page 16)

Power On/Off button

- Push the POWER ON/OFF button to switch on the power. When the power is on, push it again to switch off the power.
- Push the POWER ON/OFF button to switch on the power. If the START/PAUSE button is not pushed, the washing machine will automatically switch off the power after 5 minutes.

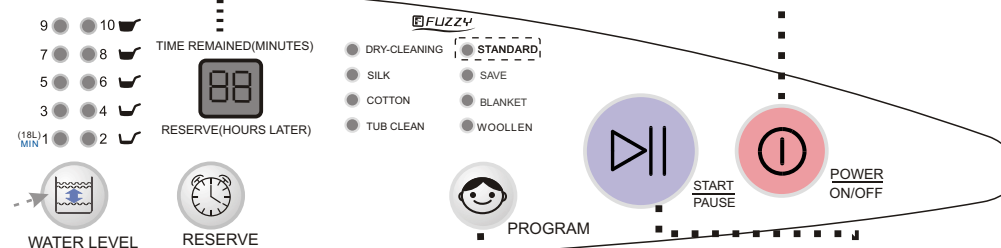

WATER LEVEL button

- If the standard program, the washing machine can detect the laundries automatically. After detection, it will set the water level to suitable value among 4, 6, 8, and 10 automatically.
- You can also set water level by yourself. After the machine is started, it will not set water level automatically. You shall push the START/PAUSE button to make new setting.
- If there's water inside the tub, the machine cannot detect the laundries and will display water level 6.
- If wet laundries are put in, it may display water level 10. You must set suitable water level by yourself.
- If SAVE program is selected, it will display water level 2. the water is never to be changed. When water level 2 is reached in water filling, it will perform washing while filling water. When water level 3 is reached, it will change to standard washing.
- During the program of the woolen or the dry-cleaning, it will display water level 10. the water level is selected from 8 to 10;
- During operation of wash and rinse program, you can push down the water level button to add water. When you release the button, or it reaches the overflow water level, the machine will stop adding water. The water level decided may be different from actual value because of the different moisture level of the laundries.

RESERVE button

- In standard operation mode, the reserve indicator light is off. The time remain indicator light is on. The digitron displays the time remained (in minute) before the washing is finished.
- Push down the RESERVE button. The digitron displays the reserve time of finishing washing (in hour). When the machine is started, the reserve indicator light is on, indicating that the reserve function is running and other lights are off.

Start/Pause button

- After the power is switched on, push it to Start the machine
- During working, push it to pause working.
- During pause, push it to resume working.

PROGRAM selection button

Program	Applicable situation
Standard	Common washing
Save	Quick and high-efficiency wash for common laundries
Blanket	Washing the relatively big and thick laundries
Woolen	Washing the woolen textiles
Dry-cleaning	Washing for laundries requiring dry-clean (see to dry-clean description and No.12 of the points of attention for details)
Silk	Washing the textile
Cotton	Washing the cotton textiles
Tub clean	Avoid growing mildew on the outer tub and the inner tub

4 Use the operation buttons

Using process

a Description of the function of the buttons

Mode and meaning of the indicator

- the frame of the indicator is on : indicate the program about to run, or indicate the selected mode

Attention

- During the machine works, all buttons except "LEVEL" button and "START/PAUSE" button unselect.
- During the machine works, opening the top lid the machine will give a beep alarm.

Digital tube

- During sensing, it displays "--"
- During operation of programs, it displays the remained time (minute) or remained times of the corresponding procedure
- The digital tube corresponding to the running program lights.

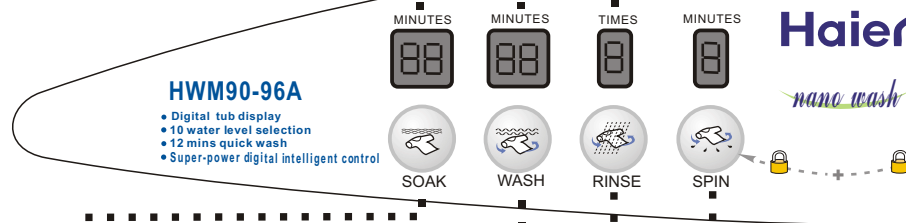

SOAK button

- Push the SOAK button to set the soak procedure.
- During standard and blanket programs, push the SOAK button to set different soak time (10,20,30 or 40 minutes)
- During cotton programs, push the SOAK button to select soak procedure, but the soak time can not be changed.
- During other programs, push the SOAK button, the machine have no reaction.

WASH button

- Push the WASH button to set the wash procedure.
- During standard and blanket programs, push the WASH button to set different wash time (from 0 to 25 minutes)
- During cotton woollen and silk programs, push the WASH button to select wash procedure, but the wash time can not be changed.
- During other programs, push the WASH button, the machine have no reaction.

RINSE button

- Push the RINSE button to set the rinse procedure.
- During standard and blanket programs, push the RINSE button to set different rinse times (0, 1,1., 2,2., 3,3., 4,4. Times) when display (1.,2.,3.,4.), the first rinse is overflowing.
- During cotton woollen and silk programs, push the RINSE button to select rinse procedure, but the rinse times can not be changed.
- During other programs, push the RINSE button, the machine have no reaction.

SPIN button

- Push the SPIN Button to set the spin
- During standard and blanket programs, push the SPIN button to set different spin time (from 0 to 9 minutes)
- During cotton, woollen and silk programs, push the SPIN button to select spin procedure, but the spin time can not be Changed.
- During the other program, push the SPIN button, the machine have no reaction

1 Preparation before washing

Using process

Preparation before washing

1. Connect the water inlet hose. Open the water faucet.
2. Confirm that the washing machine is earthed reliably. Then insert the power plug into the receptacle. The earth terminal shall not link to gas pipeline and faucet water pipeline.
3. Put down the drain hose.

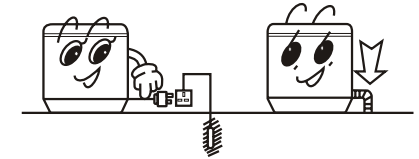

Pay attention to the followings before washing

Check if the laundries has special requirement on washing

Clear the pocket. Take out the coins, sand, hairpins etc.

Tie the long strips; fasten the buttons; close zippers.

The quantity of the laundries shall not be too large. Stretch and loosen the laundries before putting them in the tub.

When the pulsator is running, the buttons of the laundries may cause noise. For the sake of discretion, please put the laundries with buttons into other laundries.



- a. Check if the laundries are applicable for washing with machine.
- b. Divide the laundries that are not colorfast from other laundries.
- c. Put those laundries difficult to absorb water into water with hand.
- d. For those laundries with heavy soil, please first remove the dirt like mud or dust. For the parts with heavy soil, please apply detergent on them in advance, which can make it easier to remove the soil.
- e. For those laundries that may get lint ball and those with long fur, turn it over before putting in.
- f. Do not put those laundries polluted by chemicals into the washing machine directly.

2 Put in the laundries

Using process



- The capacity of washing and spinning of the machine refer to the largest weight of the standard laundries under dry condition that can be washed or spinning in one time. One time washing quantity shall be lower than the rated capacity. The largest capacity of this machine is 9.0kg.
- The thickness, size, type of the cloth will influence the actual washing capacity. It is suitable for one time washing to put in reasonable amount of laundries and the laundries can be turned round in washing.
- Do not select above 4 water level for laundries small than 1.0kg, so as to avoid splashing of water.

Reference weight of the laundries:

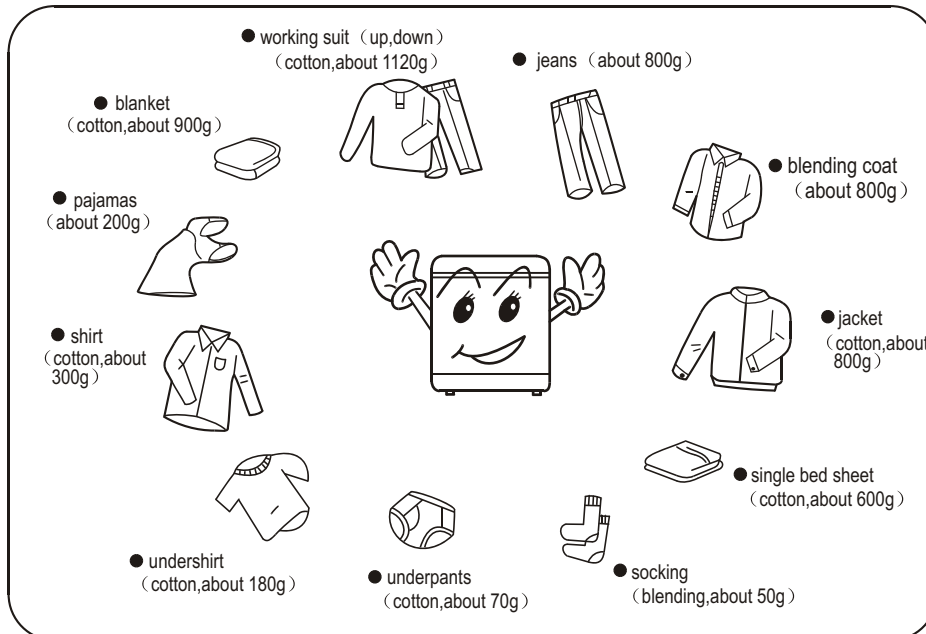

3 Usage of the detergent

Using process

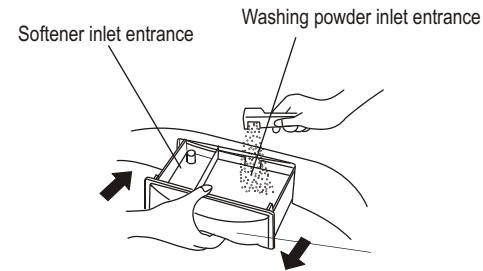

- Add the washing powder or softener into the detergent box directly as indicated in the left figure.
- After adding washing powder, please close the detergent box. See to following table for the dosage of the washing powder.

How to use the washing powder

- Direct dissolved in the machine (not applicable for fuzzy and reserve programs)
 1. Fill small quantity of water.
 2. Add the power. Run for 30 seconds to dissolve it completely.
 3. Put in the laundries. Select suitable water level.
- The instant dissolving of the washing powder:
 1. Prepare warm water of 30°C and a container.
 2. Add the powder while stirring to fully dissolve it.
- It is suggested to use liquid detergent when you use SAVE WASH.
- Please add the powder according to the laundry quantity, water level and water quantity.
- It is suggested not to use high sudsing detergent.

How to use the whitener

- Fill water to decided level. Dilute the whitener with container. Pour it slowly into the washing tub.
- Avoid using whitener on laundries with colour or pattern as they are prone to lose colour.
- The whitener shall not touch the laundries directly.
- Refer to the user's manual for the usage and quantity of the whitener.
- For powder whitener, please dissolve it before use.

How to use softener

- When you use softener, the softener must be lower than the underside of water cap.
- Please often wash the detergent box, because softener may curdle easily.
- Before use softener, you must select to disinfect clothes.

Water level, water quantity and dosage of the washing powder

Laundry quantity(kg)	Water level	Water quantity	Common powder (add 40g in each 30L water)	Concentrated powder (add 30g in each 30L water)
5.0 ~ 9.0	10 9	About 68L About 63L	About 93.3g About 88g	About 58.3g About 55g
3.5 ~ 5.0	8 7	About 56L About 50L	About 80g About 72g	About 50g About 45g
2.0 ~ 3.5	6 5	About 45L About 41L	About 64g About 56g	About 40g About 35g
1.0 ~ 2.0	4 3	About 37L About 32L	About 48g About 40g	About 30g About 25g
1.0 below	2 1	About 28L About 23L	About 32g About 24g	About 20g About 15g

Free Manuals Download Website

<http://myh66.com>

<http://usermanuals.us>

<http://www.somanuals.com>

<http://www.4manuals.cc>

<http://www.manual-lib.com>

<http://www.404manual.com>

<http://www.luxmanual.com>

<http://aubethermostatmanual.com>

Golf course search by state

<http://golfingnear.com>

Email search by domain

<http://emailbydomain.com>

Auto manuals search

<http://auto.somanuals.com>

TV manuals search

<http://tv.somanuals.com>