

Automatic Washing Machine User manual

Haier

This manual is for
HWMP55-918
HWMP65-918

- Please read this manual carefully before using.
- Retain for future reference.

Haier



CONTENTS

● Product Overview	1
● Safety Precautions.....	2-3
● Installation and Adjustment.....	4
● Installation of drainage hose.....	5
● Installation of water inlet hose.....	6
● Before washing.....	7
● Loading your laundry.....	8
● Detergent usage guide.....	8
● Operation & Wash Cycles.....	9-13
● Maintenance.....	14
● Trouble-shooting.....	15
● Packing list.....	17
● Specifications	18

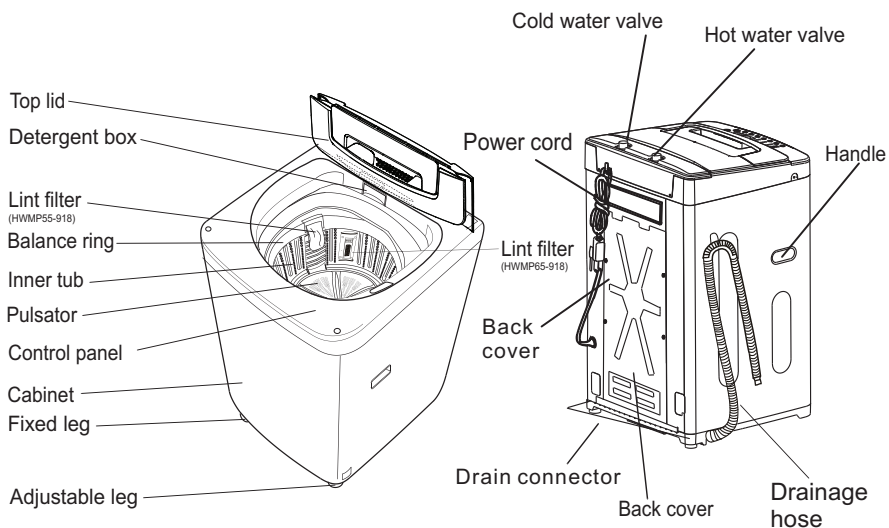
Product Overview



Description of symbols

<p>Warning sign</p> 	<p>Contents marked with this symbol are related to the safe use of the product and the personal safety of the user. Please operate in accordance to the contents of this manual, to avoid harm to the user or damage to the machine itself.</p>
<p>Forbidden sign</p> 	<p>Contents marked with this symbol indicate operations or actions that should not be undertaken by the user. Performing of such actions may result in injury to the user or damage to machine itself, and void warranty.</p>

SAFETY WARNING

Please check power socket condition to ensure it has been earthed correctly prior to installation to ensure your safety

Safety Precautions

A separate, earthed power socket is required for the power supply. Hold the plug - NOT the electric cable - when unplugging the washing machine. Do not insert or remove the power plug with wet hands. After installation of the washing machine, the power plug should be accessible.



Ensure the plug is removed and the taps turned off in the following cases: Power failure, cleaning, moving, installation and when not in use.



If power cord or other parts of this machine become damaged or faulty, please contact a technician to have it repaired. DO NOT attempt repairs yourself as this may cause personal harm or void warranty.



CAUTION: If this appliance is supplied from a cord extension set or electrical portable outlet device, the cord extension set or electrical portable outlet device must be positioned so that it is not subject to splashing or ingress of moisture.

Do not install this appliance in a damp or wet environment. Do not leave wet laundry on the Control Panel or spray water directly on to this appliance, as this may cause the washer to malfunction or cause an electrical fault.

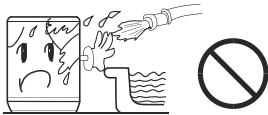

Do not connect to hot water higher than 50°C temperature



Do not block the ventilation holes with carpet. Ensure carpet does not obstruct the opening under the base of the cabinet

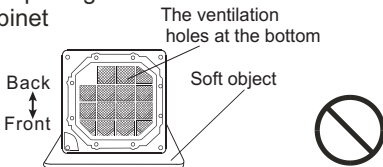

Do not wash water-proof clothing as this may affect load balance during spin cycle(s)



If you are using an extension cord or a portable electrical outlet device (not recommended), ensure that it is positioned so that it does not come into contact with water or moisture

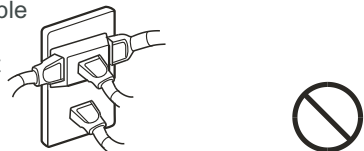

Safety precautions

Do not attempt to move washing or place hands inside washing machine while in operation. Please ensure children are supervised around machine to avoid harm.



Do not take apart, repair or alter the machine by yourself.



Do not leave hot or heavy items on lid or control panel as this may cause damage to the washer or make the washer unsafe to operate



Do not wash laundry with chemicals or other volatile materials (such as petrol, solvents or thinners) as this may cause damage to the machine.



This clothes washer is not intended for use by children and persons with reduced physical, sensory or mental capabilities, or lack of experience and knowledge, unless they have been given supervision or instruction concerning use of the appliance by a person responsible for their safety.

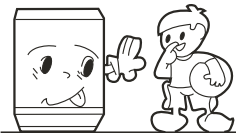

Keep washer away from heat sources such as heaters, stoves or direct sunlight.

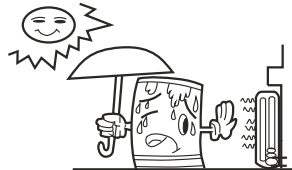

● If power cord or other parts of this machine become damaged or faulty, please contact a technician to have it repaired. DO NOT attempt repairs yourself as this may cause personal harm or void warranty.

● Please remove items such as coins, buttons, sand and other solid materials from clothing before washing.



● Check that water faucets are open after connection to machine, prior to operation and that pipes are connected correctly.

● Please use low suds/High Efficiency washing powder.

Installation & Adjustment

Please install and adjust the machine according to the directions contained in this manual. It is very important to follow these directions for the safe operation of the machine, and to ensure your machine operates correctly.

Install the lint filter

After removing washer from outer packaging, take out the lint filter from the document bag, install it to the inner tub. See the figure opposite

- Please ensure the lint filter is installed correctly and maintained in good condition to ensure the water outlet is not blocked or the flow altered. If the lint filter is lost or damaged, contact Customer Care.

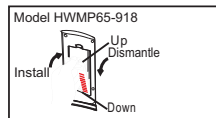
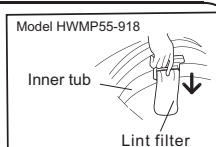

Install the bottom plate

The purpose of the bottom plate is to suppress noise from the washing machine during operation.

Steps:

1. Lay the washer on its back, on a non-abrasive surface.
2. Place the plate on to the bottom of the machine.
3. Use a screwdriver to tighten the screws (in accessory bag) securing the panel to bottom of the washer.
4. Once all screws are tight and the panel is secure, return the washer to its standing position.

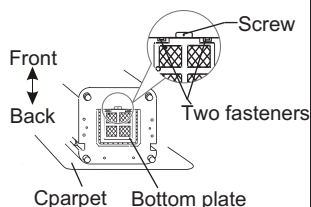

Balance washing machine

Do not install this machine on an incline greater than 2°. Installing machine on an angle or on rough ground will result in unstable running or stoppage of the machine. Please adjust it by the following method:

1. Confirm it is level
2. Lift up the side of the leg slightly and twist the adjustable leg.

Note: The distance between the washing machine and wall: at least 20 mm.

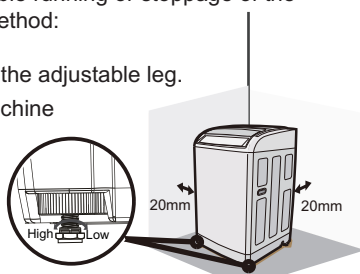
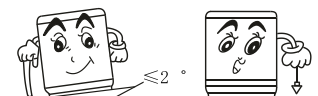

Installation of drainage hose

Install drainage hose

- First connect the drainage hose to the connection point on the lower left side of the cabinet, and fasten with drain hose hoop (provided).
- Connect drain hose guide on to the outside of drainage hose. To guide the drain hose over the tub or standpipe the hose guide MUST be fitted to the drain hose

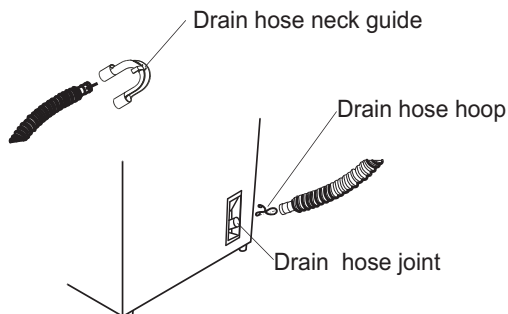

Placement of Drainage Hose

- The height of the standpipe or tub should be between 850 - 1200 mm. To avoid syphoning, the drain hose should not extend more than 20 mm from the end of the guide.
- Ensure drainage hose is held in place to avoid leaks or spills.

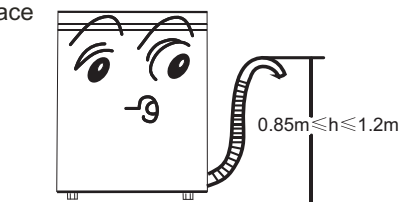

Installation of water inlet hoses

NOTE: Use the new inlet hoses supplied, do not reuse old hoses.

1. Insert a new flat washer into each end of the inlet hose.



2. Connect the water inlet hose to the water faucet. You may have to use pliers to tighten the coupling. Do not over tighten as this may cause damage to the valve or hose fittings.
3. Connect the other ends to their respective cold and hot water inlet valves located on the top of the washer.

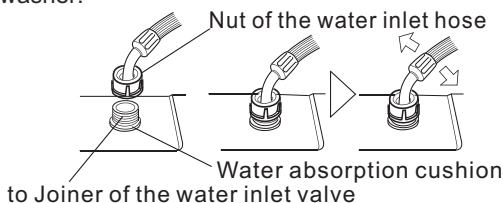

4. Fasten each hose on the washing machine, and ensure a tight connection.

Check the inlet hose connections

1. Swing the hose gently to confirm that the hose is securely fastened.
2. After installation, open the tap to check for leaks.
3. Do not bend the hose unduly.
4. Periodically check the hose connections are firm at both ends. This is to ensure the connections remain watertight over time.



Removing the water inlet hoses

1. Turn off the water taps.
2. Loosen each connection at faucet and washer.
3. Carefully remove each hose separately, as they may contain residual water.

Before washing





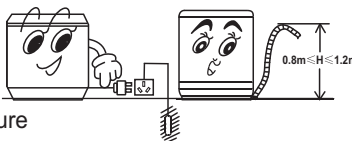

Preparation

1. Ensure the water inlet hoses are correctly installed and faucets are turned on.
2. Insert the power plug into the electrical socket.
3. Ensure the drain hose is mounted at the correct height.
4. Select a suitable location for the washer on a hard, even Surface, away from direct sunlight or heat sources, e.g. Radiators/heaters, cooking, appliances etc.
5. Any floor unevenness may result in unstable working or abnormal noise. Please ensure the machine is level.



Check the following before washing

<p>Check if the laundry has any special washing instructions</p>	<p>Clear the Pockets, and take out loose items such as coins, sand, hairpins etc.</p>	<p>Tie any long Straps or strings, fasten buttons and close zippers</p>	<p>The weight of the laundry shall not exceed the rated capacity of your machine, Loosen the laundry before placing it evenly in the tub</p>	<p>When the machine is running, buttons may cause noise. To reduce the noise, turn clothes inside out or place them in a laundry bag.</p>
				
<ol style="list-style-type: none"> a. Check if the laundry is suitable for machine washing. b. divide the laundry into colour fast and non-colour fast items. c. separate items that do not absorb water easily and wash by hand. d. for heavily soiled items, please first remove loose dirt, then apply detergent directly (as per instructions on pack) to the stain before washing. e. for those items that may attract lint or are furry or fluffy, please turn inside out before washing. f. do not put laundry soiled with chemicals or solvents into the washing machine 				

Load the laundry



- The rated washing capacity refers to the largest dry weight of a load that can be washed.
- The thickness, size and type of clothes will influence the actual capacity.
- Do not select more than Water Level “4” for clothes less than 1.0kg, to avoid splashing of water.
- It is recommended that low suds/High efficiency detergent is used.

Detergent Usage Guide

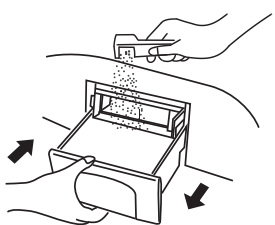

Adding washing powder

How to use Bleach/whitener

- Always refer to the bleach/whitener instructions prior to usage
- Fill water to desired level.
- Dilute the bleach/whitener in a container. Pour it slowly into the washing tub.
- Avoid using whitener on laundry with colour or patterns as they are prone lose colour.
- The bleach/whitener should NOT be directly applied to laundry directly.

- It is suggested to dissolve detergent before adding to the tub, see as below:
 1. Prepare warm water (<35 C) in a container.
 2. Add washing powder, stirring to dissolve it completely.
 - **Adding washing powder Fuzzy Logic Programs**
Add washing powder/liquid into the detergent box directly for "Fuzzy logic" programs and "Delay" program.
 - **Adding washing powder Normal Wash**
It is recommended that washing powder/liquid is dissolved with water and then directly emptied into the washing machine: (not applicable for Fuzzy Logic and Delay program)
 1. Add some water (select the "1" water level)
 2. Add washing powder/liquid. Run for about 30s to fully dissolve the detergent. Then push the "Start/Pause" button to pause the wash cycle.
 3. Load laundry. Select suitable water level. Push the "Start/Pause" button again to recommence washing cycle
 - If you select "Quick" program, it is recommended to use liquid detergent instead of washing powder to ensure the most effective wash results.
 - Old or poor quality washing powder may causing caking in tub or detergent dispenser.
 - Clean the detergent box periodically to ensure washing power is evenly distributed and remove any detergent buildup.
- Note: For best wash performance, use low suds/High Efficiency detergent and dissolve the detergent in <1L warm water prior to mixing with laundry.

Close the lid

If you open the lid during spin cycle the machine will stop and an audible alarm will sound.

Operation & Wash Cycles

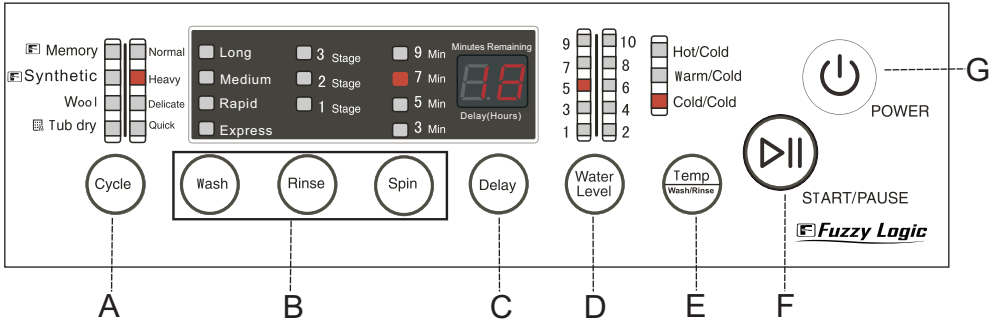

Indicator display

- Off
- On: Indicates the program is about to run and indicates the selected cycle and options
- Flashing: Indicates the program is running and indicates the selected cycle and options

Remaining time display

- Displays “-” during Fuzzy Logic detection cycle until level is determined
- Displays total remaining during current, in progress wash cycle
- Displays remaining time when the "Delay" program is used (hours).
- Displays error codes (see page 15)

Page 15

A “Cycle” button

Program	Recommended for
Normal	Recommended for mixed fabrics and general clothing items
Heavy	Items that are soiled or items that are heavy/big
Delicate	Delicate items that are machine washable
Quick	Lightly soiled or small laundry loads less then 1.5kg
Memory	This cycle setting remembers the last wash, rinse and spin settings (Water level will not be remembered as it is determined by fuzzy logic function).
Synthetic	Ideal for synthetic fabrics
Wool	Machine washable woollen items
Tub dry	Dries the inner and outer tub to avoid the growth of mildew

Operation & Wash Cycles

B “Wash” “Rinse” “Spin” button

- You may change the Wash, Rinse and Spin times when Memory , Heavy Normal and Synthetic cycles are selected.
- When the Wool cycle has been selected you cannot change the Wash, Rinse and Spin times.
- You can not change the Wash Rinse and Spin times when Tub dry and Quick cycles are selected.

C “Delay” button

- The display shows the time remaining (in minutes) before the cycle will finish.
- Push the "Delay" button and the display will show the remaining time for the cycle to finish (in hours). The indicator flashes to indicate that the delay function is operating.
- Delay start can be set for 2-24hr operation.

NOTE: The delay time is until the selected wash program finishes (you will need to deduct wash time from this delay time to calculate when the wash will start).

D “Water Level” button

- During the Memory and Synthetic programs the washing machine will detect the size of the laundry and automatically select the water level between levels 4, 6, 8 or 10.
- To change the water level, press the Start/Pause button and make your selection by pressing the “Water Level” button until desired level is shown (1-10).
- If there is water inside the tub and the machine cannot detect the laundry load, it will display water level "6". If wet laundry is put in the machine, it will display level "3", you can then manually adjust to the desired water level.
- If Quick program is selected it will display water level “3” you can then manually adjust to the desired water level.
- If Tub Dry program is selected the water level cannot be manually overridden.
- During operation of the wash, or rinse program, you can adjust the water level by pressing the Water Level button.
- The water level may vary due to the different moisture level of the laundry items.

Operation & Wash Cycles

E “Temp(Wash/Rinse) ” button

- Press the Temp(Wash/Rinse)" button to select your wash temperature.
- During “Quick” cycle, the water temperature is preset. Temp button does not work
- During wool cycle, the "hot/cold" water temperature cannot be chosen.

F “START/PAUSE” button

- After the power is switched on press the “Start/Pause” button to start the machine.
- During operation, push the Start/Pause button to pause the machine.
 - Push the Start/Pause button again to restart the machine.

G “POWER” button

- To turn on/off the power, press the power button.
- If the start pause button is not pushed within 5 minutes, the washing machine will automatically switch off the power

Button Operation and Descriptions

1 Press the “” button to switch power on/off

POWER

2 Press the “” button to select automatic program

When the power is switched on "Normal" cycle is automatically set. To select a different automatic cycle, press the "Cycle" button till the corresponding indicator is on. Refer to the section on the "Cycle" button above.

E.g choose "Quick" cycle for a small load of lightly soiled laundry. When the "Synthetic", Memory cycles are selected the Fuzzy Logic program is run. The washing cycle is automatically set while the water level and wash time can be selected according to the texture and size of the load.

Operation & Wash Cycles

3 Press the “Wash Rinse Spin” buttons to customise the pre-set options

- Even there is no water in the tub, a certain period is required before spinning
- Separate colour fast clothes before loading washing machine.
- During Rinse cycle, only SPIN times can be set, all other wash functions are locked.
- During Wool and Tub Dry cycles, these settings cannot be changed and buttons will not function, as machine will only follow pre-programmed settings.

4 Press the “Water Level” button to change the water level

- For the "Synthetic" and "Memory" cycles the machine will run a Fuzzy Logic program that automatically detects the type of laundry in the tub. After detection it will set the water level automatically.
- The water level can only be changed once the machine has started by pushing the "Start/Pause" button, then push the "Water Level" button to reset the water level. Press the "Start/Pause" button to resume the wash cycle

5 Press the “Temp Wash/Rinse” button to select the the wash and rinse temperature

Set the wash and rinse temperatures in accordance to the requirements of each load. The wash and rinse temperatures will be the same (i.e. if “Warm/Cold” is selected, both wash and rinse cycles will be warm/cold).

6 Press the “Delay” button to select the delay wash program

The delay time program is automatically off, and wash cycles will start as soon as “Start/Pause” button is pushed.

Confirm the operation of “Delay” program

- To set a delay time, first select the Cycle and options required and push the “Delay” button
- The cycle indicator lights will go off and the "Delay (Hours) indicator light will be on.
- During the delay program, press the "Delay" button to display the time remaining. The delay time indicator shows the time remaining till the wash ends.
- To cancel the delay program, switch the power off and back on, then make a new selection.
- Delay start (2-24hr) option
- Delay time is to the end of washing washing cycle

The wash will finish
in about 18 hours

Operation & Wash Cycles

7 Press the “” button to start the cycle

Start/Pause

- If the top lid is opened while machine is in SPIN cycle, the machine will stop and an audible alarm will sound.

Note:

- The energy test program was performed using the "Normal" cycle default setting of:
Wash "Long"
Rinse:1 Rinse
Spin:7 mins
Water level:10.
- Please use low suds/high efficiency detergent.

Cycle completed

When the machine has completed the selected/current wash cycle an audible alarm will sound and the machine will switch off automatically

Maintenance

- Remove the power plug before carrying out any cleaning or maintenance.
- Clean the lint filter(s) and detergent box after each wash.

Remove and clean the detergent box, replace after cleaning.

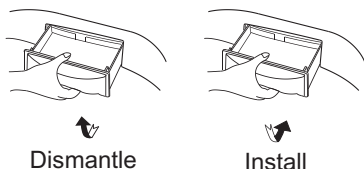

- The lint filter must be used during washing.
- It must be cleaned after each use Lint filter:
 1. Slide upwards to remove.
 2. Gently push it down to install; ensuring it is in place before next wash.

Directions for cleaning lint filter on model HWMP55-918



Directions for cleaning lint filter on model HWMP65-918

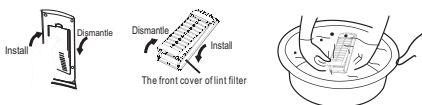

The filter at the water inlet valve may become blocked by impurities in the water supply. Clean it with a plastic bristled brush every two months.

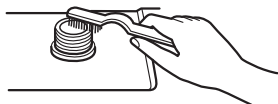

If the cabinet is dirty, wipe it with a damp cloth.

- Do not wash directly with water.
- Wipe with a neutral detergent (please check directions on detergent bottle first).
- Do not wipe machine with thinners, petrol, alcohol or other harsh solvents.

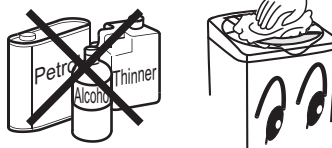

1. After washing cycle has finished, turn off the water faucet. (If needed, you can remove the water inlet hose).
2. Do not store water in the washing machine for a long period without completing a wash cycle. Drain the water completely after each wash.
3. Hang up the power cord and drain hose.
4. Wipe up any drops of water on the surface of the machine and inside the tub. Leave the lid open for about 1 hour after each wash to evaporate any residual water.

Trouble-shooting



If there is a fault or the machine does not operate correctly, remove the power plug before checking the machine. Using diagnostic list below, please check the machine requires repair. If a repair is required, please contact our Customer Care Team, do not try to fix it yourself.

Problem		Possible causes	What to do
The machine does not drain or drains slowly. The display shows E1.		<ul style="list-style-type: none"> Is the drain hose blocked? 	<ul style="list-style-type: none"> Remove the blockage. Open and close the top lid once.
The machine stops running. The display shows E2.		<ul style="list-style-type: none"> The top lid is not closed. 	<ul style="list-style-type: none"> Close the top lid.
The machine does not spin. The display shows E3..		<ul style="list-style-type: none"> Has the laundry been placed unevenly in the machine? Is the machine level? 	<ul style="list-style-type: none"> Redistribute the load evenly. Close the top lid. Level the machine. The machine will start 10. seconds after being leveled correctly.
The display will show E4.		<ul style="list-style-type: none"> Is the water tap closed or has the water supply been interrupted? Is the water inlet valve blocked? Is the water pressure too low? 	<ul style="list-style-type: none"> Open the water tap. Push the Start/Pause button once. Clean the water inlet valve then push the Start/Pause button once. Use after the water pressure is normal.
The display shows E6.		<ul style="list-style-type: none"> The water level sensor has failed. 	<ul style="list-style-type: none"> Please contact Customer Care.
The machine does not work.	Will not wash	<ul style="list-style-type: none"> Is there a power failure? Is the power plug inserted tightly? Has the water level reached preset position? 	<ul style="list-style-type: none"> Wait for the power supply to be restored. Insert the power plug tightly. Wait for water to fill to the preset level.
	Will not spin	<ul style="list-style-type: none"> Is the power plug inserted tightly? Is the top lid closed ? Is the laundry distributed unevenly in the machine? 	<ul style="list-style-type: none"> Insert the power plug tightly. Close the top lid. Redistribute the laundry.
There are abnormal sounds inside the machine.		<ul style="list-style-type: none"> Is the machine level? Has the laundry been placed unevenly in the machine? Are there any foreign objects inside the bowl? 	<ul style="list-style-type: none"> Redistribute the load evenly. Close the top lid. Level the machine. Remove the foreign object.
The water tap leaks.		<ul style="list-style-type: none"> Is the water inlet hose loose? 	<ul style="list-style-type: none"> Fasten the inlet hose.

Common occurrences

Situation	Cause
• The spinning is intermittent after it starts.	• Redistribute the load evenly. Close the top lid.
• The wash procedure pauses.	• The cloth sensor is detecting , it will add water after about 48 seconds.
• Select spin program, but it does not work.	• The program is setting the drain time, there will be a pause before the spin program starts.
• There maybe water in the drain hose in when first used.	• It maybe residual water after performance inspection by the factory.

Packing list

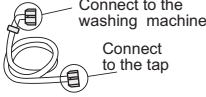
Name	Quantity	Storage position
<ul style="list-style-type: none"> ● Automatic washing machine 	<ul style="list-style-type: none"> ● One 	
<ul style="list-style-type: none"> ● Bottom plate 	<ul style="list-style-type: none"> ● One 	<ul style="list-style-type: none"> ● Between the upper cushion of the washing machine package and the upper seal of the package carton.
<ul style="list-style-type: none"> ● User manual 	<ul style="list-style-type: none"> ● One 	<ul style="list-style-type: none"> ● Inside the document bag
<ul style="list-style-type: none"> ● Warranty card 	<ul style="list-style-type: none"> ● One 	<ul style="list-style-type: none"> ● Inside the document bag
<ul style="list-style-type: none"> ● Lint filter (HWMP55-918) 	<ul style="list-style-type: none"> ● One 	<ul style="list-style-type: none"> ● Inside the document bag
<ul style="list-style-type: none"> ● Tapping screws 	<ul style="list-style-type: none"> ● One 	<ul style="list-style-type: none"> ● Inside Accessory bag
<ul style="list-style-type: none"> ● Components of the water inlet hose 	<ul style="list-style-type: none"> ● Two 	<ul style="list-style-type: none"> ● Inside Accessory bag
<ul style="list-style-type: none"> ● Drain hose 	<ul style="list-style-type: none"> ● One 	<ul style="list-style-type: none"> ● Inside Accessory bag
<ul style="list-style-type: none"> ● Drain hose Guide 	<ul style="list-style-type: none"> ● One 	<ul style="list-style-type: none"> ● Inside Accessory bag
<ul style="list-style-type: none"> ● Drain hose Clamp 	<ul style="list-style-type: none"> ● One 	<ul style="list-style-type: none"> ● Inside Accessory bag

Specifications

Type	Fully Automatic Washing Machine	
Model	HWMP55-918	HWMP65-918
Rated voltage/frequency	220-240V~ 50Hz	220-240V~ 50Hz
Rated washing power	380W	390W
Rated spinning power	340W	350W
Net weight	About 32.5kg	About 36.5kg
Gross weight	About 37.5kg	About 41.5kg
Dimensions (mm)	L 520 W 530 H 900	L 550 W 560 H 955
Water level/Water Quantity(approx)	1/14 L 2/18L 3/22L 4/26L 5/30L 6/34L 7/38L 8/43L 9/47L 10/52L	1/18L 2/24L 3/30L 4/36L 5/42L 6/48L 7/54L 8/60L 9/65L 10/70L
Water inlet pressure	0.03MPa-1.0MPa (when water temperature is 50℃, the water inlet pressure of hot water shall not exceed 0.4MPa)	

Note: Default settings when you choose this program after power on

Cycle \ Item	Wash	Rinse	Spin	Water level	Temp	Time
Normal	Long	1 Rinse	7 Min	10	Warm/Cold	97 Min(HWMP55-918) 107Min(HWMP65-918)
Heavy	Long	2 Rinses	7 Min	6	Warm/Cold	76 Min
Delicate	Rapid	2 Rinses	5 Min	6	Warm/Cold	34 Min
Quick	Express	1 Rinse	3 Min	3	Warm/Cold	10 Min
Memory	This cycle setting remembers the last wash, rinse and spin settings					
Synthetic	Medium	1 Rinse	5 Min	6	Warm/Cold	/
Wool	Express	2 Rinse	3 Min	6	Cold/Cold	25 Min
Tub dry	/	/	/	/	/	53 Min

Free Manuals Download Website

<http://myh66.com>

<http://usermanuals.us>

<http://www.somanuals.com>

<http://www.4manuals.cc>

<http://www.manual-lib.com>

<http://www.404manual.com>

<http://www.luxmanual.com>

<http://aubethermostatmanual.com>

Golf course search by state

<http://golfingnear.com>

Email search by domain

<http://emailbydomain.com>

Auto manuals search

<http://auto.somanuals.com>

TV manuals search

<http://tv.somanuals.com>