



XPB80-50

Single-tub Washing Machine



| Contents | |
|-----------------------------------|----------------|
| Before using | |
| Names of the parts..... | the 2nd cover |
| Safety precautions | 1 |
| Installation and adjustment | 3 |
| Using process | |
| Preparation before washing | 5 |
| Put in the laundries | 6 |
| Put in the detergent | 7 |
| Select the wash selector..... | 7 |
| Select the wash time | 7 |
| Close the top cover | 8 |
| Finish washing | 8 |
| Disposal after washing | 8 |
| Trouble shooting | 9 |
| Packing list | 9 |
| Specification | the back cover |



- Please read this manual carefully before using.
- Please retain it attentively for future reference.

Names of the parts

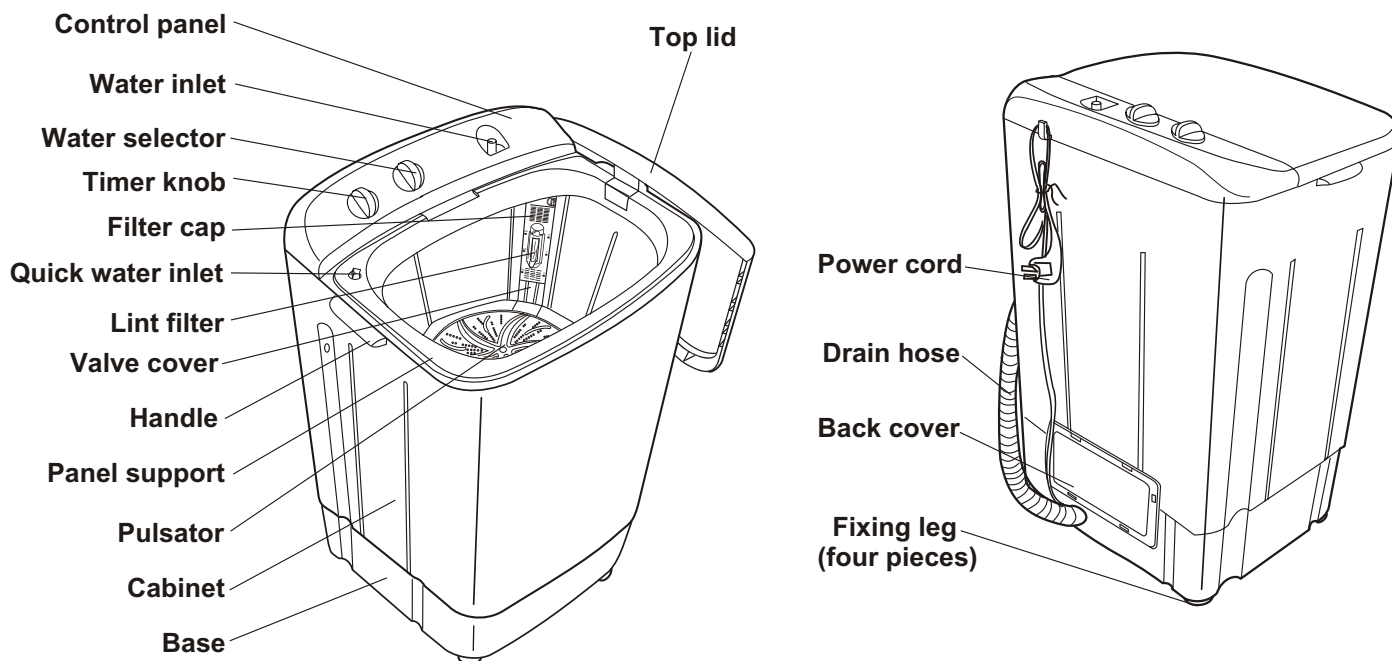
Before Using

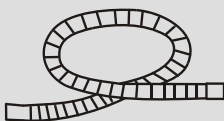

Accessories

| | |
|---|---|
|  | <p>water inlet hose (one pc)</p> |
|  | <p>Water-filling jointer (one pc)</p> |



Contents marked with that symbol are related to the safety of the product and the personal safety of the users. Please operate in strict conformity to the contents.



Contents marked with that symbol are actions forbidden to perform. Performing of those action may result in damage of the machine or influence the personal safety of the users.

Safety precautions

Before Using

Be sure to use three-phase receptacle. Earth the earthing terminal of the receptacle reliably.

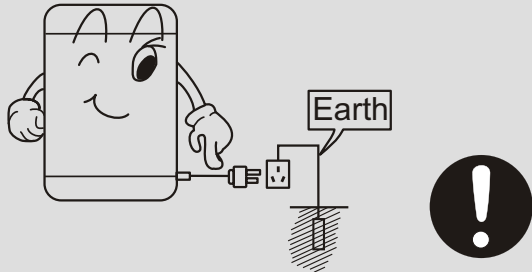

When the machine is normally using, please put the power plug at the location easily to be inserted and extracted by hand. Be sure to pull the plug off when there's power failure, or the machine is being moved, cleaned or when it is idle.

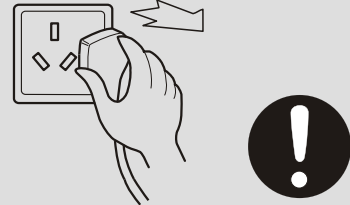

If the power cord is bad, to avoid risk it is required to replace it by the technicians of our special shop or the after-sale service department. Keep the pin of the power plug clean.

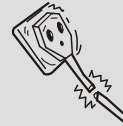

In case the washing machine is installed on ground with carpet, do not block the ventilation hole with carpet.

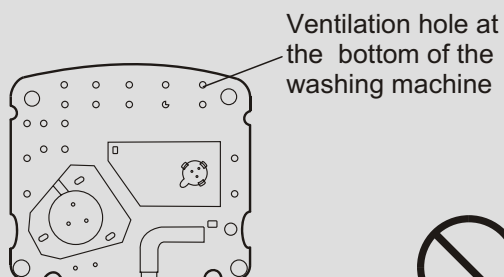

Do not use water hotter than 50°C .

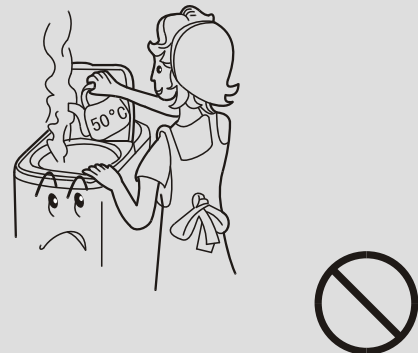

Do not put the machine at damp place like the bathroom . Never wash it with water. Do not place wet laundries on the control panel.

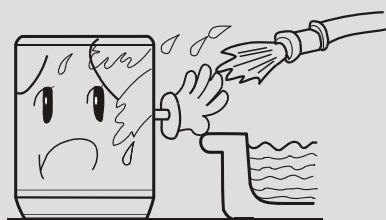

Do not share one receptacle with other electric appliances. Do not use it in case that the power plug is damaged or the inserting into the receptacle is loose.

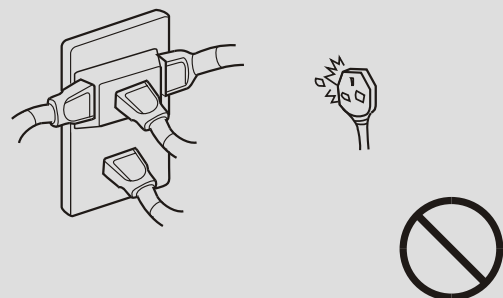

Safety precautions

Before Using

Do not stretch hands into the working machine. It is dangerous even if the rotation is slow. Take special care of the children.



Do not decompose, repair or alter the machine by yourself.

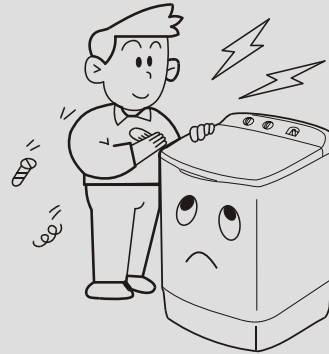

Do not put any hot or heavy items (such as the kettle with hot water) on the washing machine.



Do not wash laundries with volatile materials (such as thinner, petrol etc.).



Handicapped or children without care shall not use the machine.

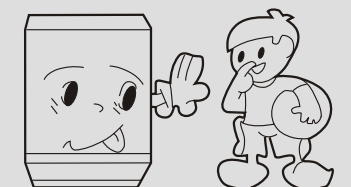

Keep the machine away from direct sunlight and heat source like the heater.

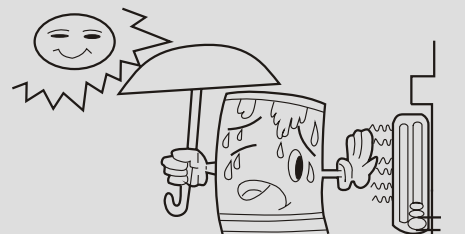

Please install and adjust the machine according to the requirement of the manual. It is very important to your security and correct operating the machine.

Usage of the drain hose

The drainage shall be smooth with the drain hose.

1. The height of the drain hose shall be less than 10cm, or the drainage will not be smooth enough and cause incomplete drainage.

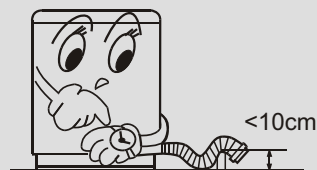

2. Do not step on or press the drain hose.

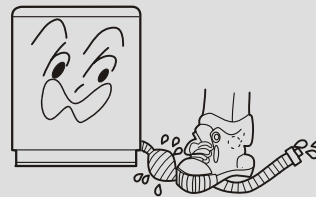

3. If extra drain hose is needed, the inner diameter of the extra hose shall not be less than 30mm, and the length shall not exceed 1.5m.

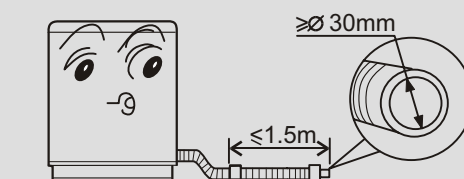

If the extra hose is too long, cut it either at point A or B.

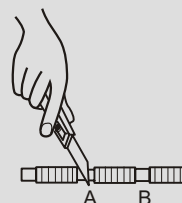

Adjust the installation position

The largest permitted slope of the bearing surface of the washing machine is 2°. Slanting or uneven ground will cause unstable operation of the machine. Please check with following methods:

- Hang a becket with weight to confirm if the washing machine is horizontal.

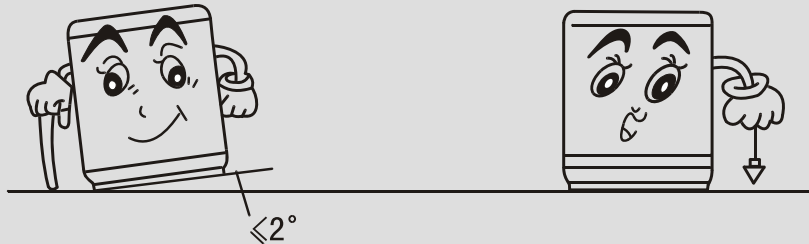

Install the water inlet hose ; Select the water level

Insert the water inlet hose into the water-inlet on the control panel directly. (pull it out to dismantle it)

Fill the water to the water level selected according to the quantity of the laundries.

Attention:

- Do not exceed the " High " water level , otherwise the water may overflow out of the machine.



Use the quick water inlet

Insert the water-filling jointer into water inlet hose, then push the water-filling jointer into the water inlet on the control panel. (To dismantle the water inlet hose, just push the control handle as indicated in the figure and pull it out)

Fill water into the wash tub directly through quick water inlet. It can reduce the humidity inside the control panel significantly and prolong the operating life of the components.

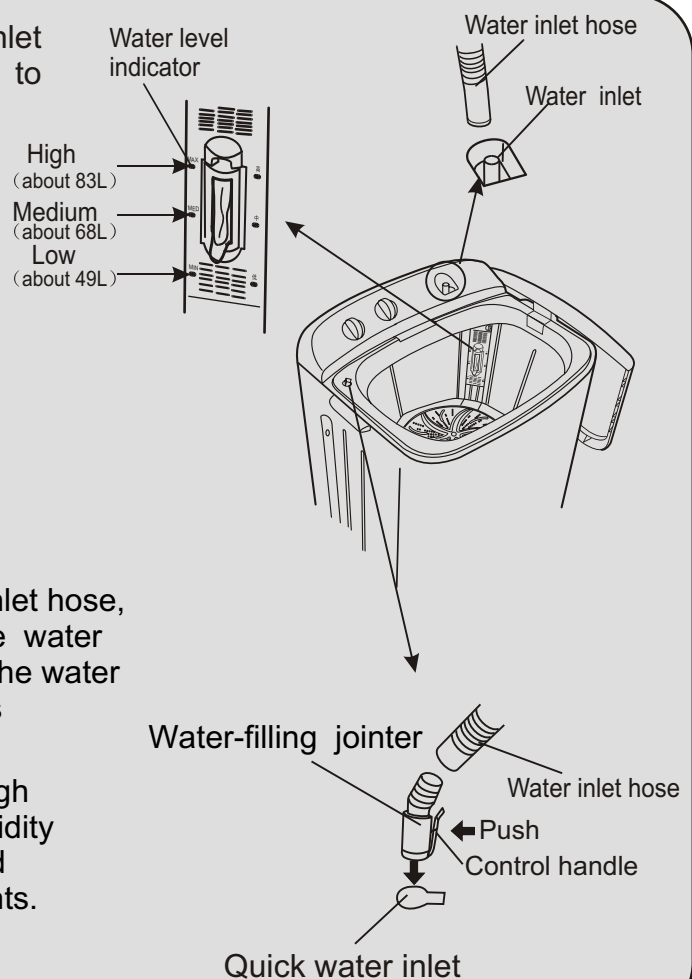

1 Preparation before washing *Using process*



Preparation before washing
 1. Connect the water inlet hose.
 2. Confirm that the washing machine is earthed reliably. Then insert the power plug into the receptacle. Do not connect the earth terminal to the gas pipe and tap water pipe.
 3. Hang the drain hose up.

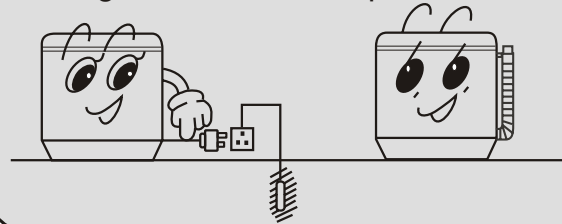

Pay attention to followings before washing the laundries

| | | | | |
|--|--|--|--|--|
| <p>Confirm if there's special requirement for the laundries.</p> | <p>Clear the pocket. Take out the coins, sand, hairpins etc.</p> | <p>Fasten the buttons and zippers.</p> | <p>The quantity of the laundries shall not exceed the rated value. The big laundries like the jeans shall be put in loosely.</p> | <p>When the pulsator is running, the buttons of the laundries may cause noise. For the sake of discretion, please put the laundries with buttons into other laundries.</p> |
| | | | | |

2 Put in the laundries

Using process



- The capacity of washing of the machine refer to the largest weight of the standard laundries under dry condition that can be washed in one time. Laundries quantity in one washing cycle shall be lower than the rated capacity.
- The thickness ,size , type of the cloth will influence the actual washing capacity. It is suitable to put in reasonable amount of laundries and the laundries can be turned round in washing for one time washing.
- Do not select " High " water level for laundries less than 4.0kg, so as to avoid splashing of water.

Reference weight of the laundries:

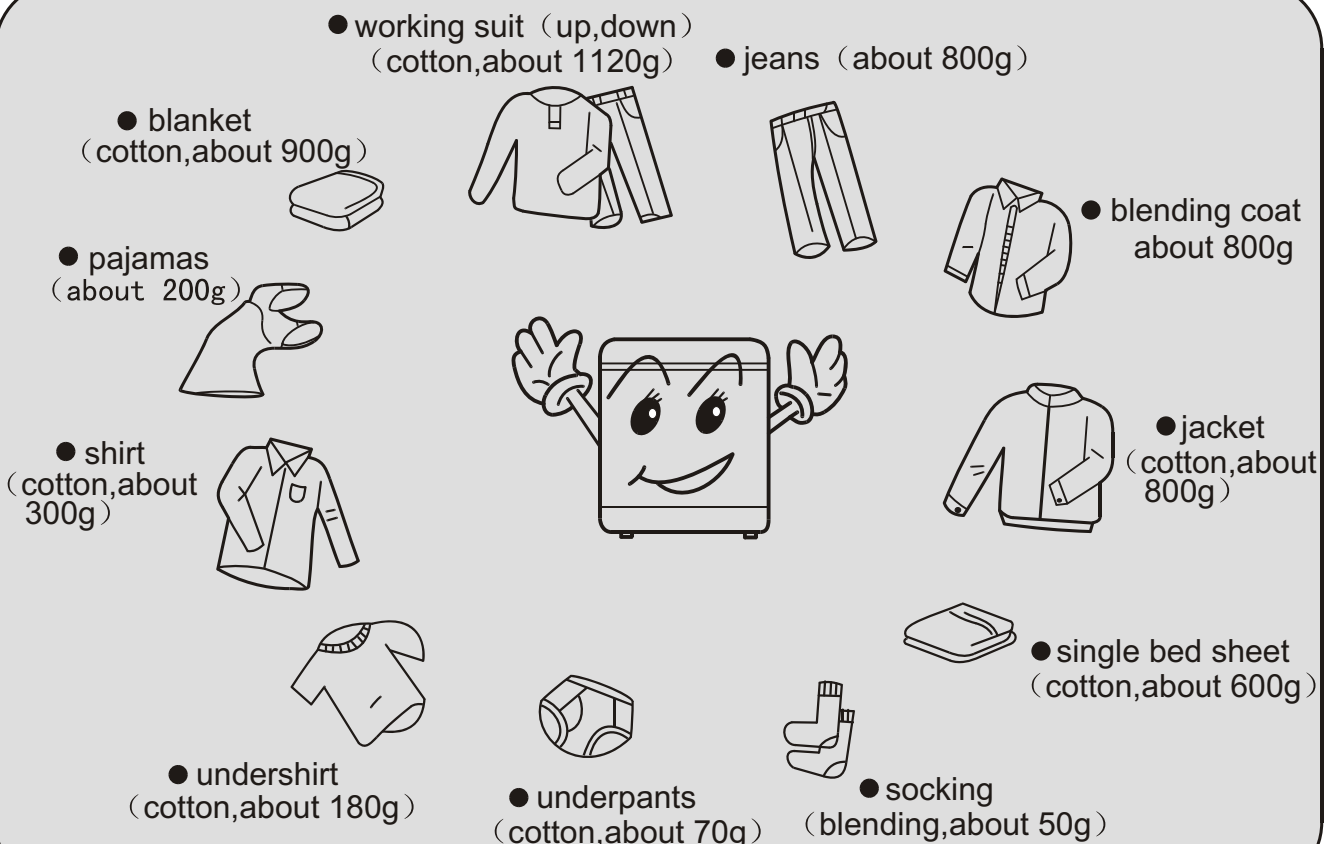

3 Put in the detergent

Using process

How to use the whitener

- Fill water to decided level. Dilute the whitener with container. Pour it slowly into the washing tub.
- Avoid using whitener on laundries with color or pattern as they are prone to lose color.
- The whitener shall not touch the laundries directly.
- Refer to the user's manual for the usage and quantity of the whitener.
- For powder whitener, please dissolve it before using.

How to use the washing powder

- | | |
|---|--|
| <ul style="list-style-type: none"> ● Direct dissolved in the machine: <ol style="list-style-type: none"> 1.Fill small quantity of water. 2.Add the powder . Run for 30 seconds to dissolve it completely. 3.Put it in the laundries. Select suitable water level. ● The instant dissolving of the washing powder: <ol style="list-style-type: none"> 1.Prepare warm water of 30°C and a container. 2.Add the powder while stirring to fully dissolve it. | <ul style="list-style-type: none"> ● The powder is more prone to pollute the laundries than the detergent. Therefore please use it with proper quantity. ● It is suggested not to use high sudsing detergent. ● Dosage of different washing powder is different. Please refer to the instruction of the washing powder for the detail dosage. |
|---|--|

Selection of the quantity of the washing powder

| Water level (Water quantity) | Standard dosage | |
|---------------------------------|-----------------------------|-----------------------|
| | Concentrated washing powder | Common washing powder |
| High (about83L) | About 75g | About 83g |
| Medium (about68L) | About 61g | About 68g |
| Low (about49L) | About 43g | About 49g |

4 select the wash selector

Please select water current according to the laundries.

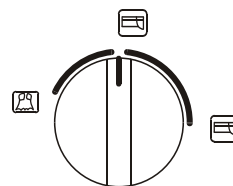

5 select the wash time

Please select wash time according to the laundries.

| Laundries | Wash time (minutes) |
|--------------------------------|---------------------|
| Silk(thin laundries) | About2~4 |
| Knitwear/chemical fiber | About3~6 |
| Bed sheet | About7~13 |
| Cotton,blending,linen | About8~10 |
| Very dirty and thick laundries | About10~13 |

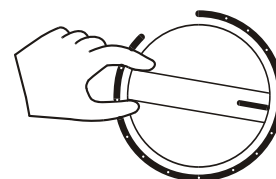

6 Close the top lid

Using process

7 Finish washing

- The pulsator stops rotating. Put down the drain hose to discharge the water.

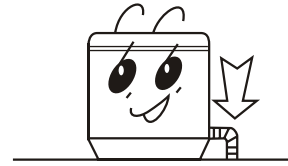

8 Disposal after washing

- After using, please clean the lint and foreign materials of the lint filter and lint frame in time. Otherwise it may influence your using the machine.
- Please first pull off the power plug from the receptacle before cleaning.

Cleaning the lint filter

- * The lint filter must be used during washing.
- * It must be cleaned in time after each using.

1. Take off the lint filter

Put hand at the indicated position.
Push down to take it off. (See to Figure 1)

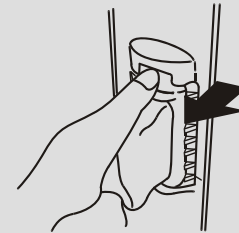

Figure 1

2. Clean the lint

Put it in water and clean while it is still wet. (See to Figure 2)

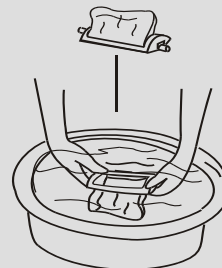

Figure 2

3. Install the lint filter

After cleaning, insert the bottom of the lint filter (marked with "down side") into the filter frame, then push the upper part of the filter in (marked with "up side"). (See to Figure 3)



Figure 3

Attention: be sure not to confuse the direction.

- Wipe the complete unit with soft cloth twisted dry.
- Wipe with neutral detergent if too dirty.
- Do not wash it directly by water.



- After washing, dismount the water inlet hose.
- Pull off the power plug and hang up the power cord.
- Do not store water in the tub for long period. Discharge the water immediately after each using.
- Wipe off the water drops on the surface and inside the tub with clean soft cloth. Open the cover of the wash tub for some time (about one hour), then close it.
- Hang up the drain hose.

Trouble-shooting

The following phenomena are not breakdowns sometimes. Please confirm again before sending it to repair.

| Phenomena | How to check |
|--|---|
| The washing machine does not act | <ul style="list-style-type: none">● Is there power failure?● Is the power plug inserted tightly? |
| There's abnormal sound inside the machine. | <ul style="list-style-type: none">● Is the machine slanting?● Is there metal item inside the tub? |
| The drainage does not work. | <ul style="list-style-type: none">● Is the drain hose put down?● Is the drain hose frozen?● Is the front end of the drain hose blocked? |

Packing list

| | |
|-------------------------|--------|
| ● User's manual | ● 1pc |
| ● Water inlet hose | ● 1pc |
| ● Water-filling jointer | ● 1pc |
| ● Washing machine | ● 1set |

Specification

| | |
|--------------------------------------|-----------------------------|
| Type | Single-tub washing machine |
| Model | XPB80-50 |
| Rated voltage • Frequency | 220V~ • 50Hz |
| Water level / Water quantity (about) | High/83L Medium/68L Low/49L |
| Rated washing capacity (kg) | 8.0 |
| Rated input power (W) | 480 |
| Dimension(mm) | L520 W490 H916 |
| Weight (kg) | 16 |
| Injection pressure | 0.02MPa~0.2MPa |



Free Manuals Download Website

<http://myh66.com>

<http://usermanuals.us>

<http://www.somanuals.com>

<http://www.4manuals.cc>

<http://www.manual-lib.com>

<http://www.404manual.com>

<http://www.luxmanual.com>

<http://aubethermostatmanual.com>

Golf course search by state

<http://golfingnear.com>

Email search by domain

<http://emailbydomain.com>

Auto manuals search

<http://auto.somanuals.com>

TV manuals search

<http://tv.somanuals.com>