

XQB42-62



Full Automatic Washing Machine



- Please read this manual carefully before using.
- Please retain it attentively for future reference.
- Please check if the power receptacle is earthed reliably before usage to guarantee your safety.
- The manufacturer is not responsible for any risks occurred owing to disobey these stipulations.

Contents

Before using

Names of the parts.....the 2 nd cover	
Safety precautions	1
Installation and adjustment	3
Install the water inlet hose.....	5

Using process

Preparation before washing	7
Put in the laundries	8
Put in the detergent	9
Use the operation buttons	10
Close the top lid	14
Finish washing	14
Disposal after washing	15

Trouble shooting • Answer to questions.....16

Packing list	17
--------------------	----

Specifications.....the back cover

Names of the parts

Before Using



Honourable users,

Thank you for choosing our products.

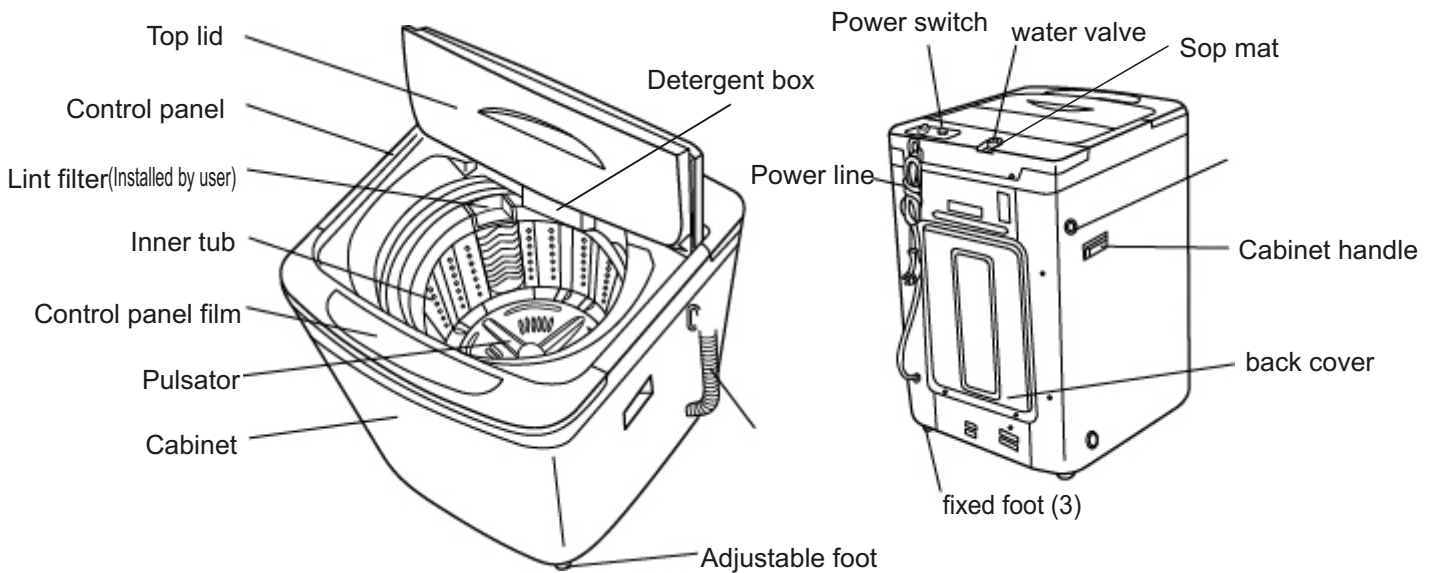

Our products integrate high-tech, precision, frontier science. To facilitate using it, please read this manual carefully and operate this machine according to it.

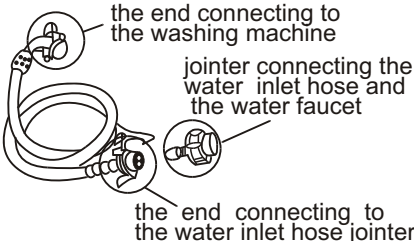

Accessories

	bottom plate (one)
	water inlet hose (one) Water inlet hose jointer (one)
	tapping screws ST4X16 (eight)

Meaning and description of the symbols

Warning sign 	Contents marked with that symbol are related to the safety of the product and the personal safety of the users. Please operate in strict conformity to the contents, otherwise it may cause damage of the machine or injure the personal safety of the user.
Forbidden sign 	Contents marked with that symbol are actions forbidden to perform. Performing of those actions may result in damage of the machine or injure the personal safety of the user.

Safety precautions

Before Using

Please insert the power cord into special receptacle with rated voltage. If the power cord is three-phase wire, please use three-phase receptacle. The earthing terminal of the receptacle must be earthed reliably. If it is two-phase wire, please guarantee that the earthing wire is earthed reliably. If possible, please adopt electric leakage protector.

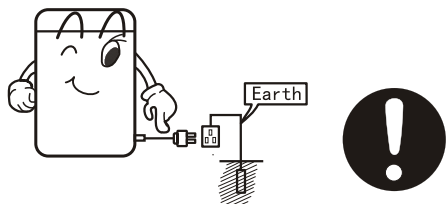

The power cord plug should be convenient to be plugged in or plugged out with hand while the washing machine runs normally. Be sure to pull the plug out and close the water tap when the machine is idle, when moving the machine, or when cleaning the machine. Do not use wet hand to insert or pull out the power plug.



Do not damage the power cord, bend, extend, twist, bind or alter it by force. Do not press or nip it with weight. If the power cord or the power plug is bad, or the power plug becomes flexible, to avoid risk it is required to have it replaced by the technicians of our special shop or the after-sale service department. Keep the pin of the power plug clean, if the power plug is polluted with dust, please wipe with dry cloth carefully.



Do not put the machine at damp place like the bathroom. Never wash it with water. Not put wet laundries on the control panel.

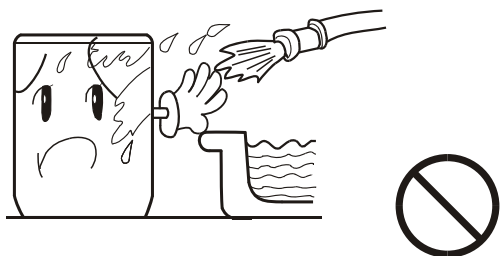

Do not use water hotter above 50°C.



In case the washing machine is installed on ground with carpet, do not block the ventilation hole with carpet.

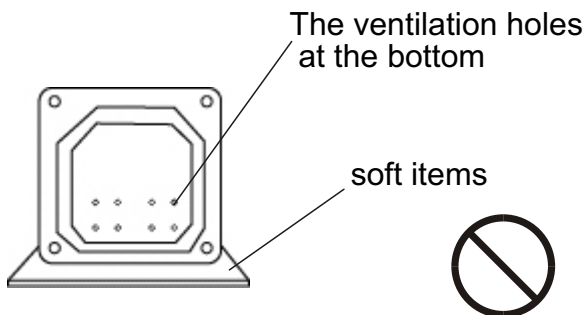

Do not wash water-proof laundries like the raincoat, bike covers etc. to avoid abnormal vibrations in spinning.

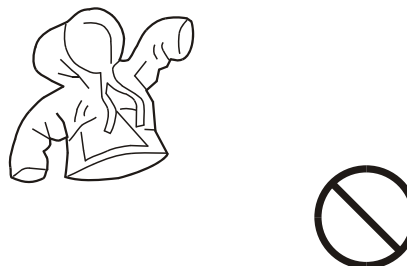

Do not let the machine share one receptacle with other electric appliances. If the power plug is damaged, or the plugging into the receptacle is loose, do not use the plug any more.



Before Using

Do not stretch hands into the working machine. It is dangerous even if the rotation is slow. Take special care of the children. Do not let the children climb the washing machine.



Do not decompose, repair or alter the machine by yourself.

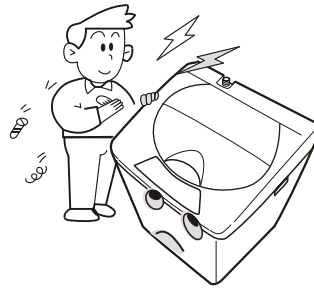

Do not put any hot or heavy items (such as the kettle with hot water) on the washing machine.



Do not wash laundries with volatile materials (such as thinner, petrol etc.)



The handicapped or children without care shall not use the machine.

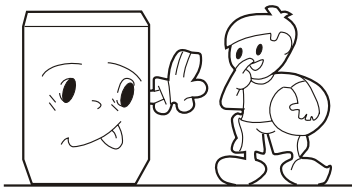

Keep the machine away from direct sunlight and heat source like the heater.

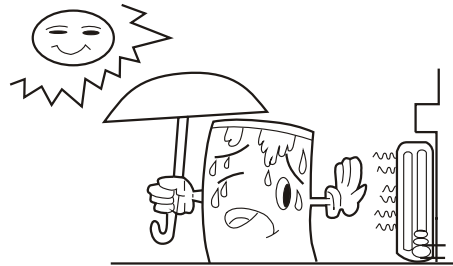

Please keep the lint filter in good condition, and install it to proper position. If the lint filter is lost or damaged, please contact the local after-sales service department of our company.

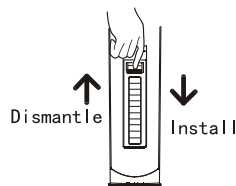

To prevent your laundries and washing machine from damage, be sure to take out all of the foreign materials from your pocket, such as coins, buttons, sand or hairpins etc.

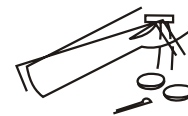

- Before washing, please check if the water tap is open, and if the water inlet pipe is connected properly.
- It is suggested to use low-foaming washing powder

Installation and adjustment

Before Using

Please install and adjust the machine according to the requirement of the manual. It is very important to your security and correct operating the machine.

Install the lint filter

1. Press downward to assemble.
2. Pull upward to detach.

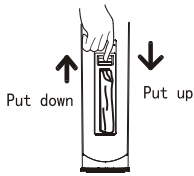

Install the bottom plate

After you open the package, please lean the washing machine gently down on soft items (like the towel cloth, blanket, etc.). Install the bottom plate to the bottom of the machine with the eight screws by a cross screwdriver, then lift the machine up gently. See to the figure:

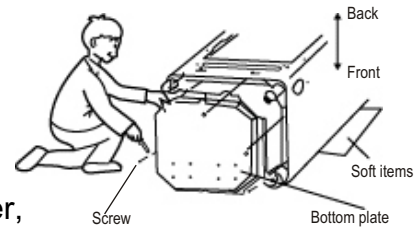

Adjust the installation position

The washing machine shall be more than 20mm away from the wall. The largest allowed slope of the shank base of the machine is 2° . The slanting or rough ground will result in unstable running or stoppage of the machine. Please adjust it with following methods:

- **Confirm it's horizontal:**

Hang the lead line to check if it is horizontal.

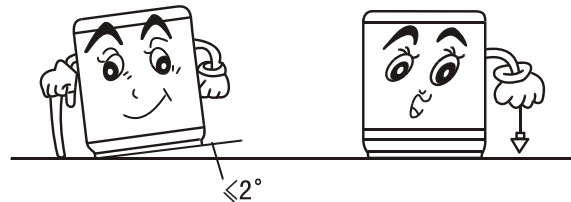

- **Adjust the adjustable foot:**

1. To twist the adjustable foot, please first lift up the side of the foot slightly, loosen the adjustable nut, and twist the foot.
2. Fasten the nut after adjustment.

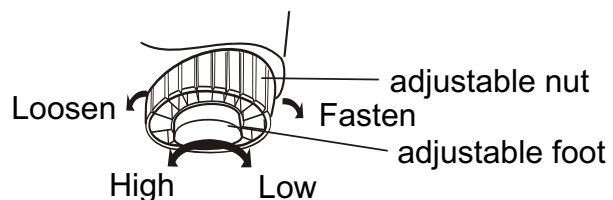

Usage of the lower drain hose

The drainage shall be smooth with the drain hose.

1. The height of the drain hose shall be less than 10 Cm, or the drainage will not be smooth , and cost such long time that machine may stop at mid way.

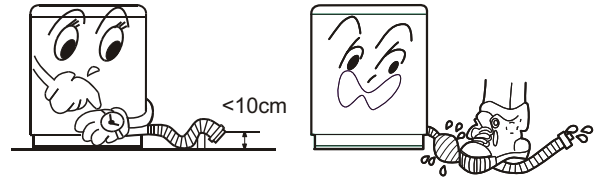

2. Do not step on or press the drain hose.



3. If the drain hose is too long , cut it at mid point. To make smooth drainage, cut the front end of the hose into slope.

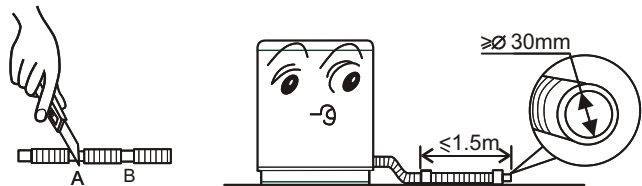

4. If extra drain hose is needed, please make separate purchase. The inner diameter of the extra hose shall not less than 30 mm, and the length shall not exceed 1.5m.

If the extra hose is too long, cut it either at A or at B point.

Remarks: during operation, be sure to put down the drain hose to ground to ensure that the recycled water can flow out. Otherwise it will result in incomplete recycled water drainage, and unable to spin etc.

Useage the drain hose

- Before using , hang up the drain hose on suitable location. Do not put down the drain hose on the ground.
- Confirm the end of drain hose is higher than the level of tub . If not the siphon will being .

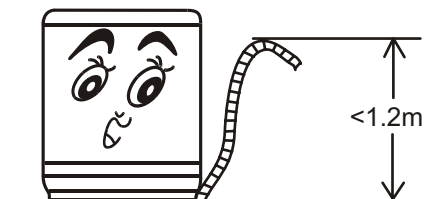

Install the water inlet hose

Confirm the water tap

Before Using

Water tap, suitable

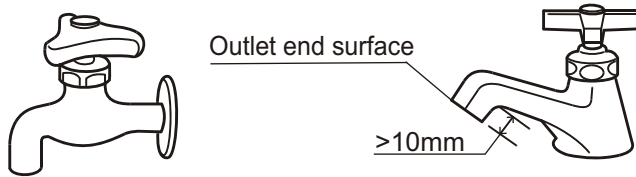

Water tap, not suitable

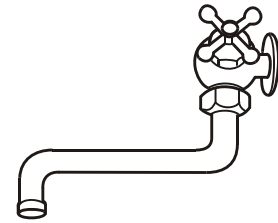

It is required that the front end shall be longer than 10mm.
The outlet end surface of the tap shall be flat and smooth. If not please file it to avoid leakage.

Connection between the water inlet hose jointer and the water tap

1. Use the new water inlet hose provided with the machine to connect to the water faucet. Old hose sets should not be reused.
2. Press the lower end of the lock lever and push down the slider. Take off the water inlet hose jointer from the water inlet hose component. See to Figure 1.
3. Loosen the screw till the water tap can be accessed. Put the jointer of the water inlet hose on the tap. See to Figure 2. (If the tap diameter is too large and the jointer can not be set on the water tap, please loosen the four screws and take out the bushing in the jointer. See to the figure3.)

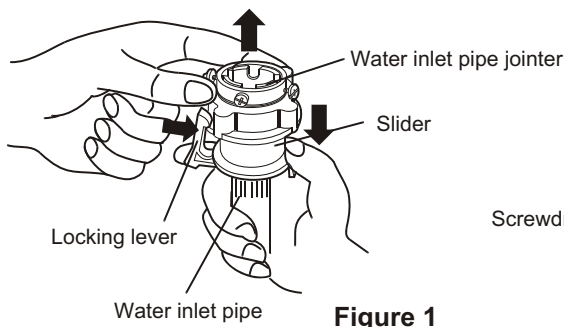

Figure 1

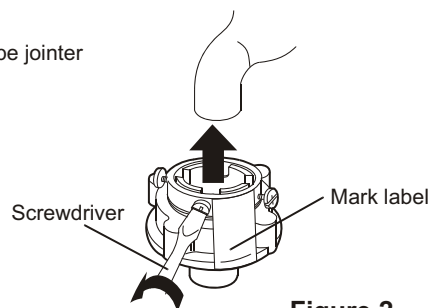

Figure 2

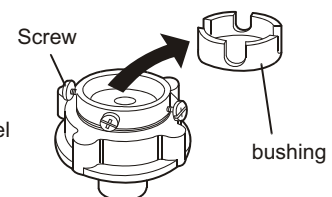

Figure 3

4. Fasten the four screws evenly. See to Figure 4.
5. Take off the nameplate. Twist the fastening nut as per the indication of the figure. See to Figure 5.

Remarks: Before twisting the fastening nut, the thread is 4mm above the upper surface of the nut. After twisting the fastening nut, the thread is 2mm above the upper surface of the nut. See to Figure 6.

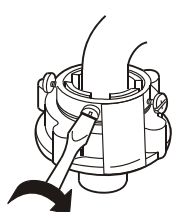

Figure 4

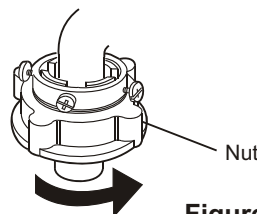

Figure 5

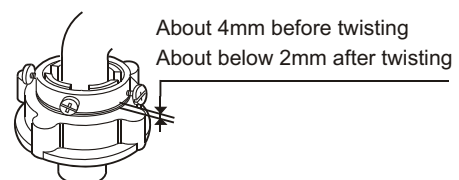
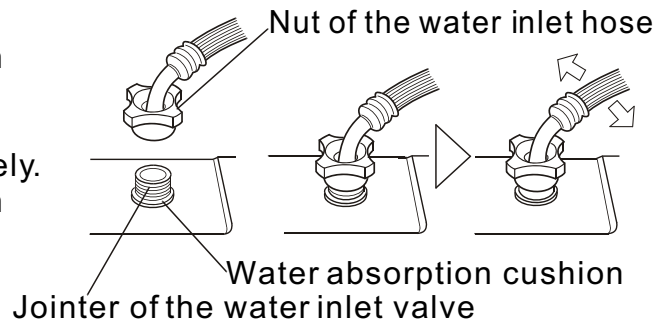

Figure 6

Connection between the water inlet hose and the washing machine

1. Do not take off the water absorption cushion. Please check if the cushion is dropped or damaged before each usage. If it happens please contact our after-sale department immediately.
2. Put the nut of the water inlet hose on the valve jointer.
3. Fasten the nut. Swaying it gently to confirm if it's suitable.



Connection between the jointer of the water inlet hose and the water inlet hose

1. Push down the slider. Insert the water inlet hose into the jointer.
2. Hang the lock lever to the jointer. Release the slider till a click sound is heard.

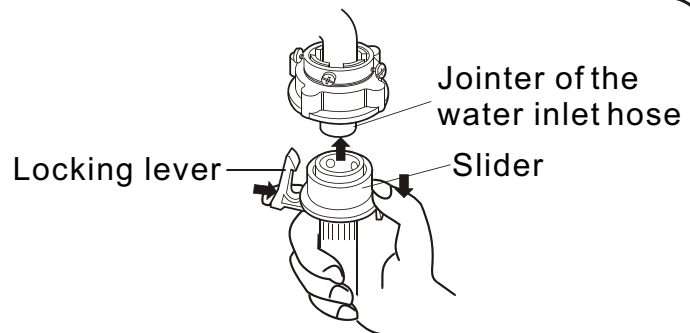

Check the connection between the jointer of the water inlet hose and the water tap

1. Swaying the hose gently to confirm if it is fastened stable.
2. After installation, open the tap to check if it leaks.
3. Do not bend the hose with overstrain.
4. Before each usage please check if the connection between the jointer of the water inlet hose and the water tap, and the installation of the water inlet hose are firm, so as to prevent dropping from improper

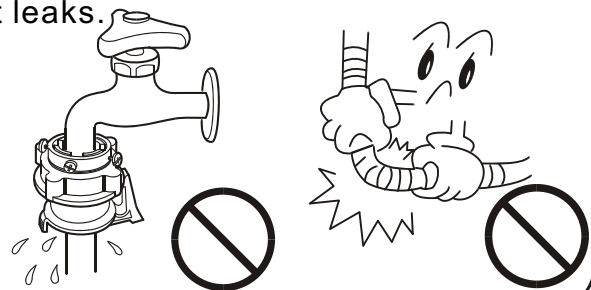

Take down the water inlet hose

1. Close the water tap.
2. Press the locking lever. Push down the slider. Then pull off the water inlet hose. If the machine is used more than once every week, the jointer of the water inlet hose can be kept on the tap to prevent damaging the fixing screw.

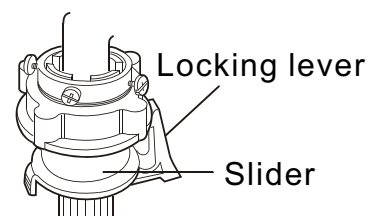

1 Preparation before washing *Using process*



Preparation before washing

1. Connect the water inlet hose and open the water tap .
2. Confirm that the washing machine is earthed reliably . Then insert the power plug into the receptacle. Do not connect the earth terminal to the gas pipe and tap water pipe.
3. Put up the drain hose.

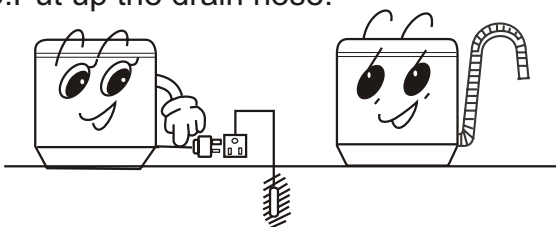

Pay attention to followings before washing the laundries

Confirm if there's special requirement for the laundries.

Clear the pocket. Take out the coins , sand, hairpins etc.

Fasten the buttons and zippers.

The quantity of the laundries shall not exceed the rated value. The big laundries like the jeans shall be put in loosely.

When the pulsator is running , the buttons of the laundries may cause noise. For the sake of discretion, please put the laundries with buttons into other laundries.



- a. Please check if the laundries are applicable for washing.
- b. Separate those not colorfast from other laundries.
- c. For laundries not waterabsorbing, please put them into water with hands.
- d. For laundries with much soil, please remove the soil first. You can add detergent on the part with serious soil directly. It is much easier to remove the soil by that mean.
- e. For laundries likely to get lint ball or with long fiber, please first turn the inside out before putting them into the water.
- f. Do not put the laundries polluted with chemicals directly into the washing machine.
- g. For those small laundries ,laundries likely to be twisted or worn, and woolen laundries, please put them into mesh bag before wasing.

2 Put in the laundries

Using process



- The capacity of washing and spinning of the machine refer to the largest weight of the standard laundries under dry condition that can be washed or spinned in one time. One time washing quantity shall be lower than the rated capacity. The largest capacity of this machine is 4.2kg.
- The thickness, size, type of the cloth will influence the actual washing capacity. It is suitable for one time washing to put in reasonable amount of laundries and the laundries can be turned round in washing.
- Do not select "High" water level for laundries less than 1.0kg, so as to avoid splashing of water.
- To wash thin laundries like the stocking, silk etc., please first put them into washing mesh bag (which can be purchased separately) before wash.

Reference weight of the laundries:

● working suit (up,down)
(cotton,about 1120g) ● jeans (about 800g)

● blanket
(cotton,about 900g)

● pajamas
(about 200g)

● shirt
(cotton,about 300g)

● undershirt
(cotton,about 180g)

● underpants
(cotton,about 70g)

● Socks
(blending,about 50g)

● blending coat
(about 800g)

● jacket
(cotton,about 800g)

● single bed sheet
(cotton,about 600g)

3 Put in the detergent

Using process

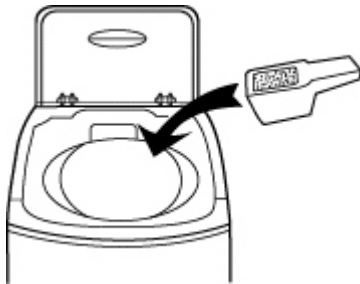

How to use the whitener

- Fill water to decided level. Dilute the whitener with container. Pour it slowly into the washing tub.
- Avoid using whitener on laundries with color or pattern as they are prone to lose color.
- The whitener shall not touch the laundries directly.
- Refer to the user's manual for the usage and quantity of the whitener.
- For powder whitener, please dissolve it before use.

How to use the washing powder

- Direct dissolved in the machine
 - 1.Fill water to "Low" water level.
 - 2.Add the power. Run for 30 seconds to dissolve it completely.
 - 3.Put in the laundries. Select suitable water level.
- The instant dissolving of the washing powder:
 - 1.Prepare warm water of 30°C and a container.
 - 2.Add the powder while stirring to fully dissolve it.
- The powder is more prone to pollute the laundries than the detergent. Therefore please use it with proper quantity.
- It is suggested not to use high sudsing detergent.
- Different washing powders have different dosage. Please refer to the usage manual of the washing powder for the details.



Standard usage quantity of the detergent and water quantity

Laundries quantity(kg)	Water level	Water quantity	Common powder (Add 40g in each 30L water)	Concentrated powder (Add 25g in each 30L water)
Above 2.5	High	About 36L	About 48g	About 30g
1.0~2.5	Medium	About 30L	About 40g	About 25g
Below 1.0	Low	About 21L	About 28g	About 17.5g

4 Use the operation buttons *Using process*

a. Description of the function of the buttons

Mode and meaning of the indicator light

-  : Flashing: indicate the running program
-  : On: indicate the program about to run, or indicate the selected mode
-  : Flashing rapidly: indicate abnormal condition

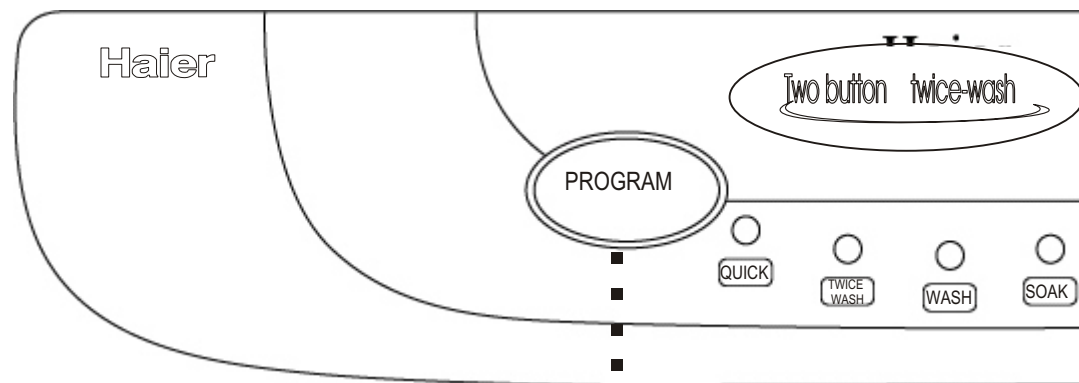

Procedure selection

- one or more one out of the five procedure programs are available for your option: quick、twice-wash、wash、rinse、spin.

Using process

“start/pause” button

After the power is switched on, push it to start the machine

- During working, push it to pause working.
- During pause, push it to resume working.

"Power switch" button

- Push the "On/Off" button to switch on the power.
- When the power is on, push it again to switch off the power.

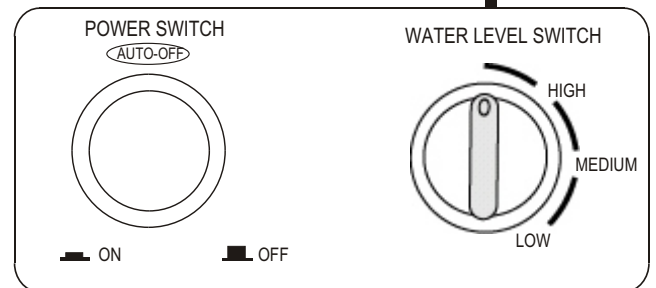

"Water Level Selection" button

- Select or adjust the water level.

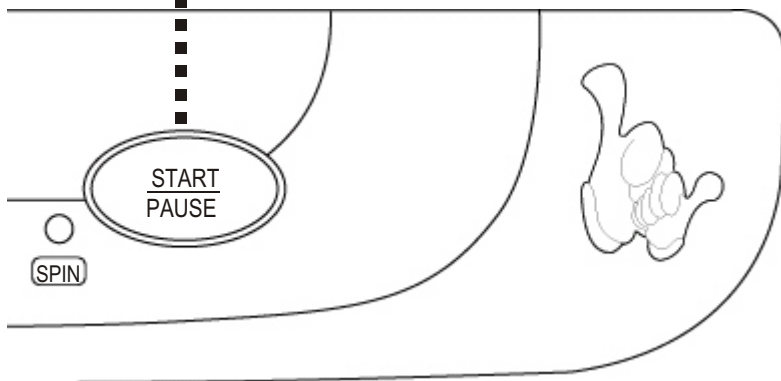

Description:

1. Push the power button to switch on the power. If the machine is idle for 10 minutes, the power will be switched off automatically.
2. In usage, please first push the "Power switch" button, then push the "Procedure selection" button. After selection, adjust the water level. Finally push the "start/pause" button to start the machine.

b. Operating procedure and explanations for the buttons

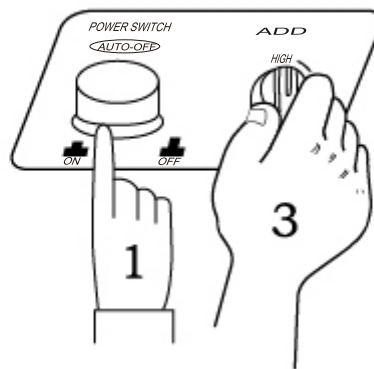
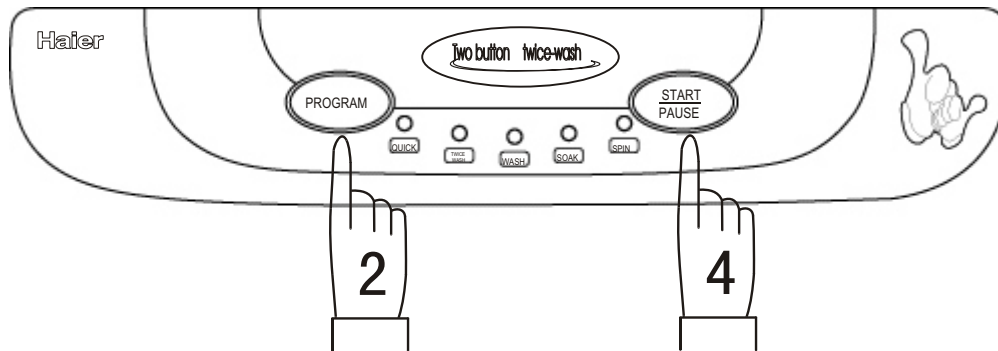

1 Push the "Power switch" button to switch on the power.

2 Press the "PROGRAM" button to select the suitable procedure program.



After switching on the power, the machine will set to standard program automatically including "wash-rinse-spin". To select other program, push the "Procedure selection" button to select one or more programs among "quick wash" "twice wash" "wash" "rinse" "spin". Refer to the "Procedure selection method" for the selection.



Attention

- Even there's no water in the tub, the spinning will start after a certain period.
- Do not use the "Twice wash" program for the woolen laundries.
- Wash the laundries that are prone to lose colors separately from other laundries.
- The pulsator will not rotate unless the water is filled to selected water level.

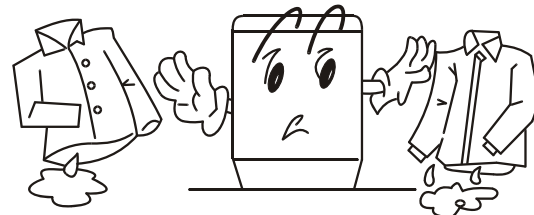

Selection method of the procedure programs

Times of pushing the "Process Selector" button	Selected procedure program	Applicable procedure	Contents (the lighted indicators indicate the programs about to run)							
0	Wash, rinse, spin (standard program)	When the common laundries need washing, rinsing and spinning	Speedy wash ●	Twice wash ●	Wash	rinse	spin	○	○	○
1	Wash (the washing liquid remains in the tub)	Repeat using the washing liquid	Speedy wash ●	Twice wash ●	Wash	rinse	spin	○	●	●
2	Wash, rinse (the rinsing liquid remains in the tub)	Repeat using the washing liquid	Speedy wash ●	Twice wash ●	Wash	rinse	spin	○	○	●
3	Rinse, spin	When the laundries need rinsing and spinning after manual washing	Speedy wash ●	Twice wash ●	Wash	rinse	spin	●	○	○
4	Spin (spin after drain)	When the laundries need only spinning after manual washing (first drain then spin)	Speedy wash ●	Twice wash ●	Wash	rinse	spin	●	●	○
5	Twice wash, wash, rinse, spin	If the laundries are very dirty, or the sleeve and collar are dirty, first soak then wash	Speedy wash ●	Twice wash ○	Wash	rinse	spin	○	○	○
6	Speedy wash, wash, rinse, spin	When quickly wash the light dirty laundries.	Speedy wash ○	Twice wash ●	Wash	rinse	spin	○	○	○

- If you push the "Process Selector" button for 7 times, it will resume the original mode, and it will circulate like that.
- If you select the "Speedy wash" program, you have to set the full procedure of wash, rinse and spin. The procedure cannot be selected.

Time list of each program (minute)

Program	Soak (min)	Wash (min)	Rinse (min/time)	Spin (min)	Total time (min)
Standard	—	About 12	Rinse twice with stored water, about 3	About 4	About 42
Twice wash	About 25	About 24	Rinse twice with stored water, about 3	About 4	About 82
Speedy wash	—	About 6	Rinse once with stored water, about 3	About 4	About 25

Using process

- * Total time: including the normal water inlet time, drain time, excluding the power off time. The total washing time may be influenced by the water inlet pressure and water level.
- * Spin time: the time from intermittent running to finishing
- * When selecting " Twice wash " program, first soak for about 20 minutes, pre-wash for about 8 minutes, then soak for about 5 minutes, then do washing, rinsing and spinning. The wash time in the list includes the pre-wash time

3.Adjust the "water level selection" knob to select suitable water level

- Three water levels available according to the laundries quantity: High; Medium; Low.



- After the water inlet as per the preset water level, in case additional water quantity is required, please first set the button to the "Reset", push and hold it to perform automatic water inlet. When it reaches the suitable water level, you can turn it to the needed water level.
- After the water inlet under set water level, if higher water level is needed, please first turn the knob to " Reset ", then turn back to needed water level. The washing machine will fill water to the new water level.

4 Press the "Start/Pause" button

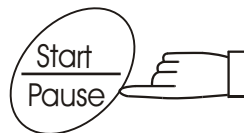

5 Close the top lid

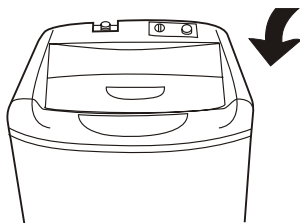

If you open the top lid, the machine will stop working before spinning

6 The washing is finished



It beeps to indicate the finishing of washing

When the washing is finished, The power will be switched off automatically about 10 minutes after the finishing of the washing.

7 Disposal after washing

Using process

- After using, please clean the lint and foreign materials of the lint filter etc. in time. Otherwise it may influence your using the machine.
- Please first pull off the power plug from the receptacle before cleaning.

- The lint filter must be used during washing.
- It must be cleaned in time after each using

Lint filter:

1. Rotate the inner tub with hand till the lint filter reaches the position convenient for you to take it off. Pull it up to dismount.
2. Push it down to install.
3. Clean the filter screen after washing.

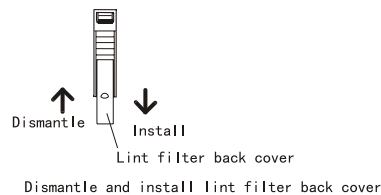
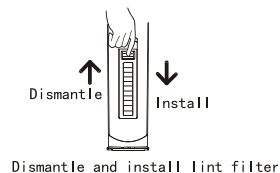

The filter screen of the water inlet valve is likely to be blocked by foreign materials and influence the water inlet. Please clean it with brush every two months.

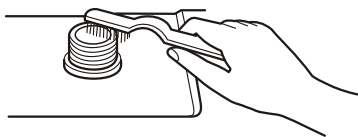

If the cabinet is dirty, wipe it with wet cloth

- Do not flush it directly with water.
- Wipe it with neutral detergent.
- Do not wipe it with thinner, petrol, alcohol etc.

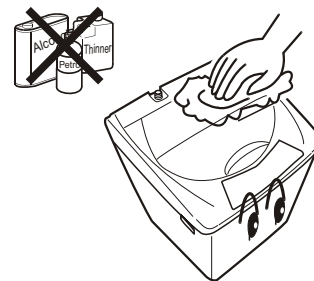

1. After washing, close the water faucet. (If needed, you can dismantle the water inlet hose).
2. Do not store water in the washing machine for a long period. Drain the water completely after each using.
3. Be sure to pull off the power plug before maintenance.
4. Hang up the power cord and drain hose.
5. Wipe off the water drops on the surface of the machine and inside the tub. Open the top lid for some time (about 1 hour), then close the top lid.

Trouble shooting • Answer to question

(If there's breakdown, please pull off the power plug before checking) The following phenomena are not breakdowns sometimes. Please confirm again before sending it to repair. If there are real breakdowns, please come to the special maintenance department or after-sale service department of our company. Do not repair it by yourself.

Phenomenan	The reason	How to settle
In spinning, the machine stops running. (The "wash" "rinse" "spin" indicator flash quickly)	<ul style="list-style-type: none"> ● The top lid is not closed. 	<ul style="list-style-type: none"> ● Close the top lid.
The draining does not work, or the speed of draining is too slow (the indicators of "rinse" "spin" flash)	<ul style="list-style-type: none"> ● Is the drain hose put down? ● Is the drain hose blocked by foreign material? 	<ul style="list-style-type: none"> ● Put down the drain hose. Open and close the top lid once. ● Clean the foreign material. Open and close the top lid once.
The safety switch acts. The spinning can not work (the indicators of "wash" "rinse" flash quickly)	<ul style="list-style-type: none"> ● Are the laundries put slantingly? ● Is the machine slanting? 	<ul style="list-style-type: none"> ● Re-order the laundries. Close the top lid. ● Level the machine in right position. Open and close the top lid once.
The program pauses after about 8 minutes of water inlet (the indicators of "wash" "spin" flash quickly)	<ul style="list-style-type: none"> ● The water faucet is not open. ● The water inlet valve is blocked. ● The water pressure is too low and the current is too small. 	<ul style="list-style-type: none"> ● Open the water faucet. Push the "Start/Pause" button. ● Clean the water inlet valve. Push the "Start/Pause" button. ● Wait for the normal water pressure before use.
The machine does not act.	<ul style="list-style-type: none"> ● Is there power failure? ● Is the power plug loose? 	<ul style="list-style-type: none"> ● Use it when the power is on. ● Insert the power plug tightly.
There's abnormal sound inside the machine.	<ul style="list-style-type: none"> ● Is the machine slanting? ● Are the laundries slanting in spinning? 	<ul style="list-style-type: none"> ● Level the machine properly. ● Re-order the laundries.
The water faucet leaks.	<ul style="list-style-type: none"> ● Is the jointer screw of the water inlet hose is loose or twisted awry? 	<ul style="list-style-type: none"> ● Fasten the jointer screw properly.

Common phenomena

Phenomena	Explanation
<ul style="list-style-type: none"> ● The spinning is intermittent when it starts. 	<ul style="list-style-type: none"> ● Balance the laundries to avoid slanting.
<ul style="list-style-type: none"> ● Push the "Process selector" button to select "Spin", but it doesn't work. 	<ul style="list-style-type: none"> ● The program is setting the drain time. Some time is needed before it starts spinning.
<ul style="list-style-type: none"> ● There may be some water flowing out of the drain hose in the first use of the machine. 	<ul style="list-style-type: none"> ● It is the water remained in the factory inspection of performance.
<ul style="list-style-type: none"> ● In the final spinning, it stops and displays "Rinse", and starts water inlet. 	<ul style="list-style-type: none"> ● It is because that the laundries are slanting to one side, and the safety switch acts. After water inlet and stirring, the slanting will be removed and the spinning will work.

Packing list

Name	Quantity	Storage position
● User's manual	● One	● Inside the document bag
● Certificate of qualification	● One	● Inside the document bag
● Post card	● One	● Inside the document bag
● Certificate of warranty	● One	● Inside the document bag
● Components of the water inlet hose	● One	● Inside the accessory bag
● Bottom plate	● One	● Between the upper cushion of the washing machine package and the upper seal of the package carton
● Tapping screws ST4x12-A	● Eight	● Inside the accessory bag
● Computerized Automatic washing machine	● One	

After-sales service

Honorable users:

Thank you for using Haier series washing machine. We will offer you following services according to the stipulation in the Act on Protection of Consumers' Rights and Interests by evidences of your Guarantee certificate and invoice:

1. Three years' guarantee for the whole machine on our account.
2. The following cases are not included in above guarantee:
 - (1) Those damaged by improper transportation, handling, using and maintenance by users.
 - (2) Those decomposed by self.
 - (3) Those with altered invoice or without invoice and guarantee certificate.
 - (4) Those damaged by outer reasons such as abnormal voltage, fire, etc.
 - (5) Those not used according to the operating handbook and the notice on the labels of the machine cabinet.
 - (6) Those used outside family (such as public machines, those used for business purpose, those used as accessories of automobiles and ships, etc.).

If you meet any difficulty in use please call the local after-sales service department according to the certificate of warranty. We will offer sincere services for you.

Remarks:

Future changes on the structure and technical data of this model are not to be informed to the users.

If extra water inlet hose and drain hose are needed, following components are available for purchase: (1) water inlet hose (0.5m, 1m) (2) drain hose (3) washing bag

Specification

Model	XQB42-62
Rated voltage • frequency	220V ~ • 50Hz
Rated washing / spinning capacity	4.2kg (weight of standard dry cloth)
Water level/Water quantity (about)	High/36L, Medium/30L, Low/21L
Max water consumption	About 108L(High water level; Standard program)
Injection pressure	0.03Mpa-0.78Mpa
Rated washing power	325W
Rated spinning power	255W
Weight About	29kg
Dimension	L 555 mm W 510 mm H 870 mm

Free Manuals Download Website

<http://myh66.com>

<http://usermanuals.us>

<http://www.somanuals.com>

<http://www.4manuals.cc>

<http://www.manual-lib.com>

<http://www.404manual.com>

<http://www.luxmanual.com>

<http://aubethermostatmanual.com>

Golf course search by state

<http://golfingnear.com>

Email search by domain

<http://emailbydomain.com>

Auto manuals search

<http://auto.somanuals.com>

TV manuals search

<http://tv.somanuals.com>