

Automatic Washing Machine

User's manual

Haier

This manual is for
XQB50-10A

- Please read this manual carefully before using.
- Retain it for future reference.

The Haier logo consists of the word "Haier" in a bold, white, sans-serif font, centered within a dark gray square.

Contents





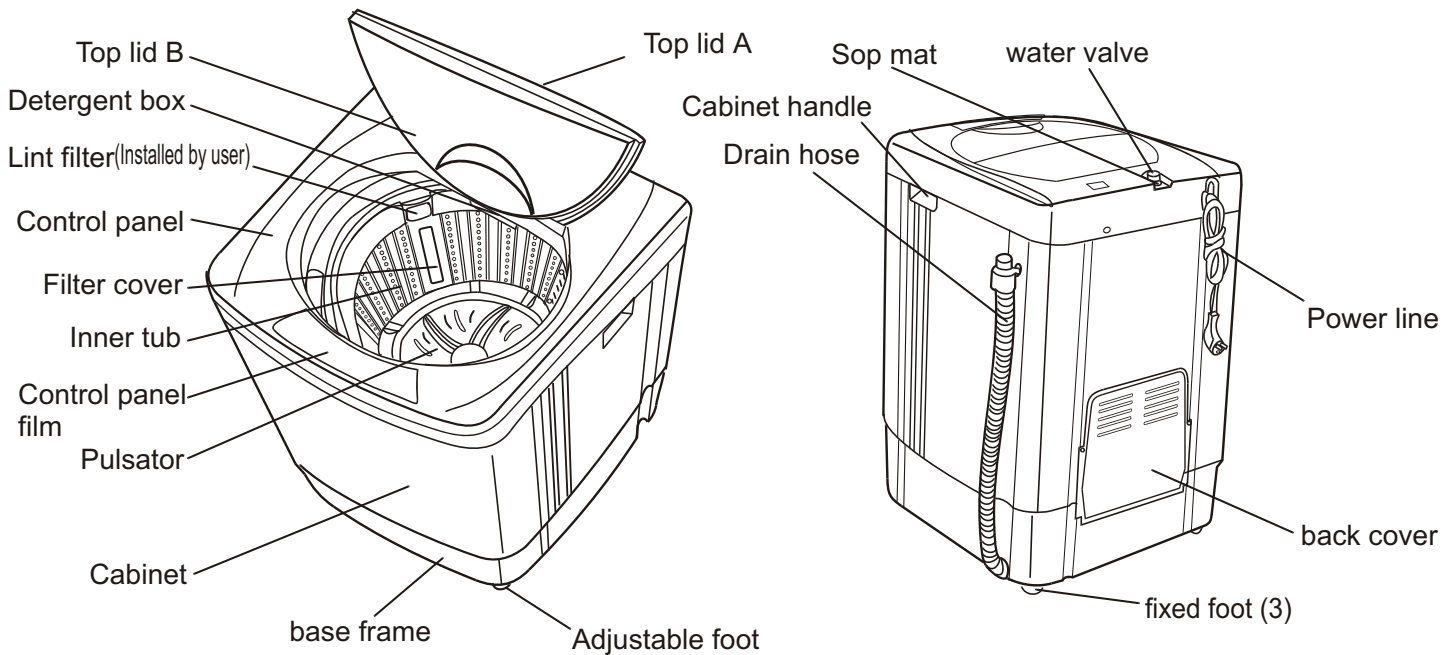

Names of the parts.....the 2 nd cover	
Safety precautions	1
Installation and adjustment	3
Install the water inlet hose.....	5
Using process	
Preparation before washing	6
Put in the laundries	7
Put in the detergent	8
Use the operation buttons	9
Close the top lid	13
Finish washing	14
Disposal after washing	14
Trouble shooting • Answer to questions....	15
Packing list	16
Specifications.....	17

Names of the parts

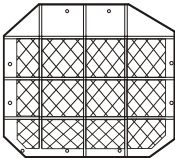

Before Using



Accessories

	Bottom plate (one)
	water inlet hose (one)
	Drain hose
	Drain hose support
	tapping screws ST4X16 (eight)
	Lint filter (two)

Meaning and description of the symbols

<p>Warning sign</p> 	<p>Contents marked with that symbol are related to the safety of the product and the personal safety of the users. Please operate in strict conformity to the contents, otherwise it may cause damage of the machine or injure the personal safety of the user.</p>
<p>Forbidden sign</p> 	<p>Contents marked with that symbol are actions forbidden to perform. Performing of those actions may result in damage of the machine or injure the personal safety of the user.</p>

Safety precautions

Before Using

Please plug the plug on special 120V AC receptacle. Please guarantee that the earthing wire is earthed reliably.

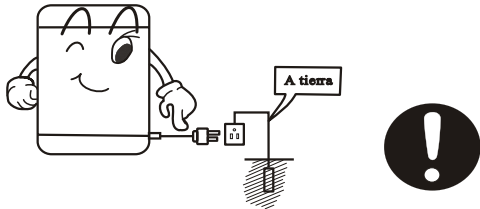

The power cord plug should be convenient to be plugged in or plugged out with hand while the washing machine runs normally. Be sure to pull the plug out and close the water tap when the machine is idle, when moving the machine, or when cleaning the machine. Do not use wet hand to insert or pull out the power plug.

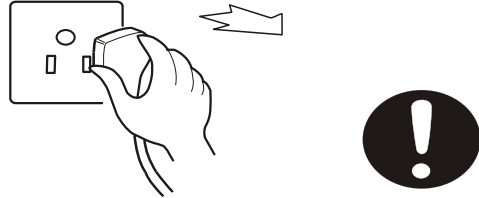

- Do not bend, extend, twist, bind by force. Do not press or nip it with weight.
- Keep the pin of the power plug clean, if the power plug is polluted with dust, please wipe with dry cloth carefully.



Do not put the machine at damp place like the bathroom. Never wash it with water. Do not put wet laundries on the control panel.

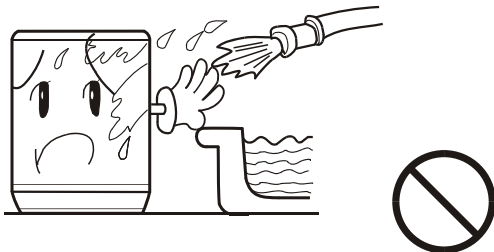

Do not use water hotter above 50°C.

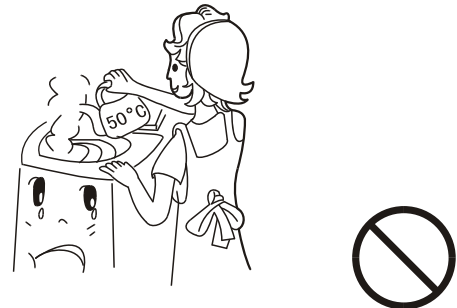

In case the washing machine is installed on ground with carpet, do not block the ventilation hole with carpet.

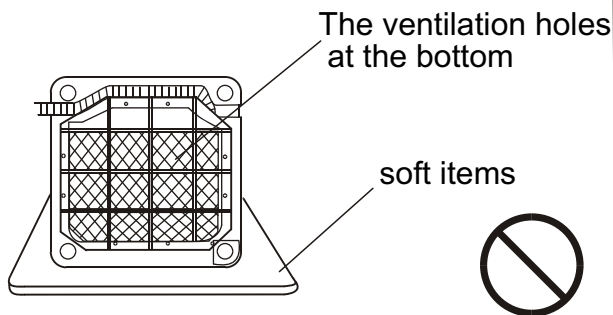

Do not wash water-proof laundries like the raincoat, bike covers etc. to avoid abnormal vibrations in spinning.

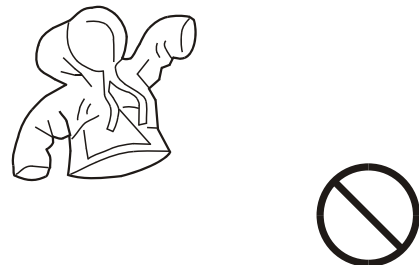

Do not let the machine share one receptacle with other electric appliances. If the power plug is damaged, or the plugging into the receptacle is loose, do not use the plug any more.



Before Using

Do not stretch hands into the working machine. It is dangerous even if the rotation is slow. Take special care of the children. Do not let the children climb the washing machine.



Do not decompose, repair or alter the machine by yourself.

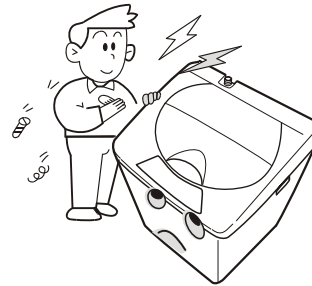

Do not put any hot or heavy items (such as the kettle with hot water) on the washing machine.



Do not wash laundries with volatile materials (such as thinner, petrol etc.)

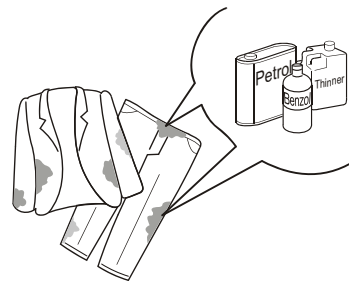

The handicapped or children without care shall not use the machine.

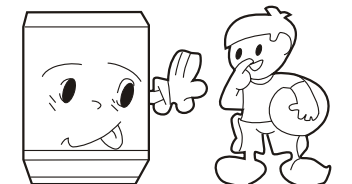

Keep the machine away from direct sunlight and heat source like the heater.

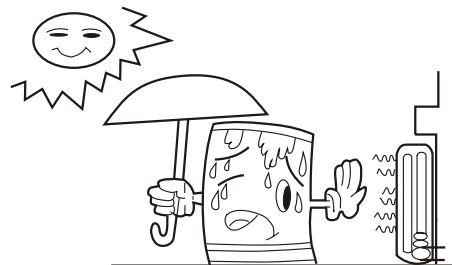

To prevent your laundries and washing machine from damage, be sure to take out all of the foreign materials from your pocket, such as coins, buttons, sand or hairpins etc.



- Before washing, please check if the water tap is open, and if the water inlet pipe is connected properly.
- It is suggested to use low-foaming washing powder

To prevent the lint in the tub from blocking the cascade outlet and influencing the cascade effect, please keep the lint filter in good condition, and install it to proper position during washing.

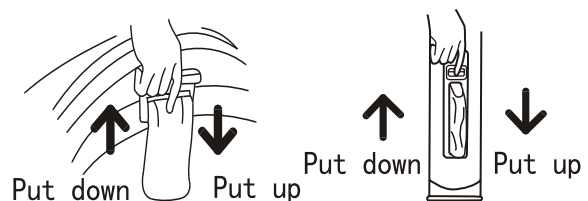

Installation and adjustment

Please install and adjust the machine according to the requirement of the manual. It is very important to your security and correct operating the machine.

Install the lint filter

1. Press downward to assemble.
2. Pull upward to detach.

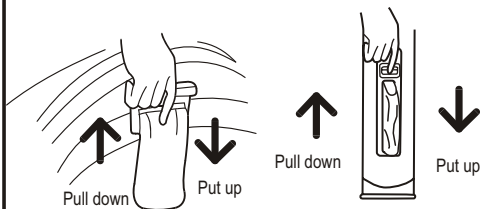

Install the bottom plate

After you open the package, please lean the washing machine gently down on soft items (like the towel cloth, blanket, etc.). Install the bottom plate to the bottom of the machine with the eight screws by a cross screwdriver, then lift the machine up gently. See to the figure:

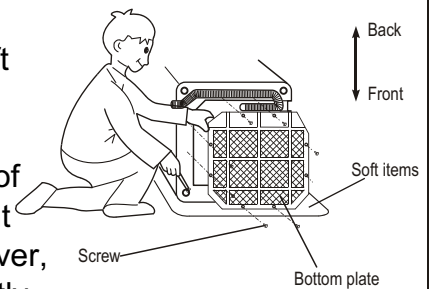

Adjust the installation position

The largest allowed slope of the shank base of the machine is 2° . The slanting or rough ground will result in unstable running or stoppage of the machine. Please adjust it with following methods:

- **Adjust the adjustable foot:**

1. To twist the adjustable foot, please first lift up the side of the foot slightly, loosen the adjustable nut, and twist the foot.
2. Fasten the nut after adjustment.

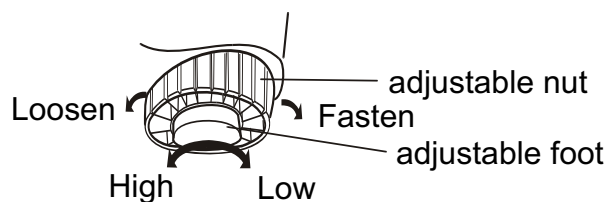
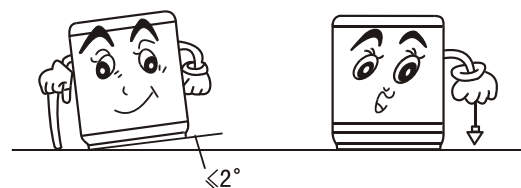

Usage of the drain hose

The drainage shall be smooth with the drain hose.

- 1.put the drain hose up to suitable position. Do not put it on ground
- 2.Do not step on or press the drain hose.

Notes: the highest point of drain pipe should be higher than the water level of washing tub for avoiding to siphon phenomenon during drain.

The highest point

$$0.8\text{m} \leq H \leq 1.2\text{m}$$

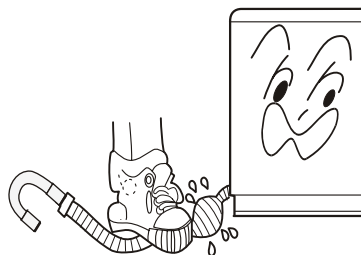
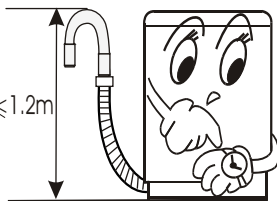

Install the water inlet hose

Before using

Install the water inlet hose

1. Insert a new flat washer into each end of the inlet hoses. Firmly put the washers in the coupling.

Note:

- Use the new hose sets supplied with the washer. Any other old hose sets should not be used.
- You may have to use pliers to tighten the coupling. Do not over tighten because you may cause damage to the valve.

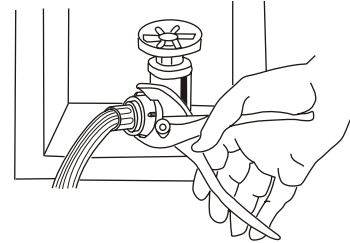

2. Connect the water inlet hoses to the water faucet.

3. Connect the other ends to their respective cold and hot water inlet valve located at the rear of the washer

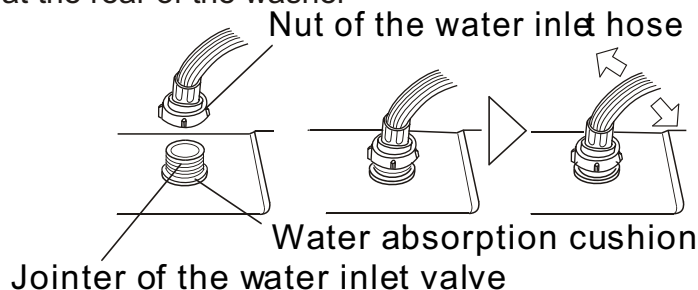

4. Fasten the nut. Swing it gently to confirm if it's suitable.

Check the connection between the water inlet hose and the water tap

1. Swaying the hose gently to confirm if it is fastened stable.
2. After installation, open the tap to check if it leaks.
3. Do not bend the hose with overstrain.
4. Before each usage please check if the connection between the water inlet hose and the water tap, and the connection between the water inlet hose and washer are firm, so as to prevent dropping from improve Installation position.



Take down the water inlet hose

1. Close the water tap.
2. Pull off the water inlet hose from the water tap and washer

1 Preparation before washing *Using process*



Preparation before washing

1. Connect the water inlet hose.
2. Confirm that the washing machine is earthed reliably. Then insert the power plug into the receptacle. Do not connect the earth terminal to the gas pipe and tap water pipe.
3. Hang up the drain hose.

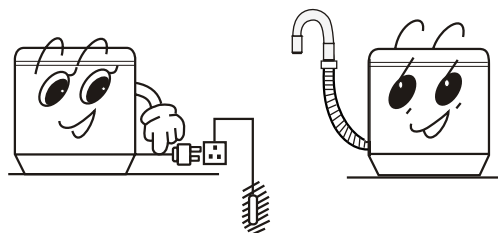

Pay attention to followings before washing the laundries

<p>Confirm if there's special requirement for the laundries.</p>	<p>Clear the pocket. Take out the coins, sand, hairpins etc.</p>	<p>Fasten the buttons and zippers.</p>	<p>The quantity of the laundries shall not exceed the rated value. The big laundries like the jeans shall be put in loosely.</p>	<p>When the pulsator is running, the buttons of the laundries may cause noise. For the sake of discretion, please put the laundries with buttons into other laundries.</p>

- A. Check if the laundries are applicable for washing with machine.
- b. Divide the laundries that are not colorfast from other laundries.
- c. Put those laundries difficult to absorb water into water with hand.
- d. For those laundries with heavy soil, please first remove the dirt like mud or dust. For the parts with heavy soil, please apply detergent on them in advance, which can make it easier to remove the soil.
- e. For those laundries that may get lint ball and those with long fur, turn it over before putting in.
- f. Do not put those laundries polluted by chemicals into the washing machine directly.

2 Put in the laundries

Using process



- The capacity of washing and spinning of the machine refer to the largest weight of the standard laundries under dry condition that can be washed or spinned in one time. One time washing quantity shall be lower than the rated capacity. The largest capacity of this machine is 5.0kg.
- The thickness, size, type of the cloth will influence the actual washing capacity. It is suitable for one time washing to put in reasonable amount of laundries and the laundries can be turned round in washing.
- Do not select "High" water level for laundries small than 0.5kg, so as to avoid splashing of water.

Reference weight of the laundries:

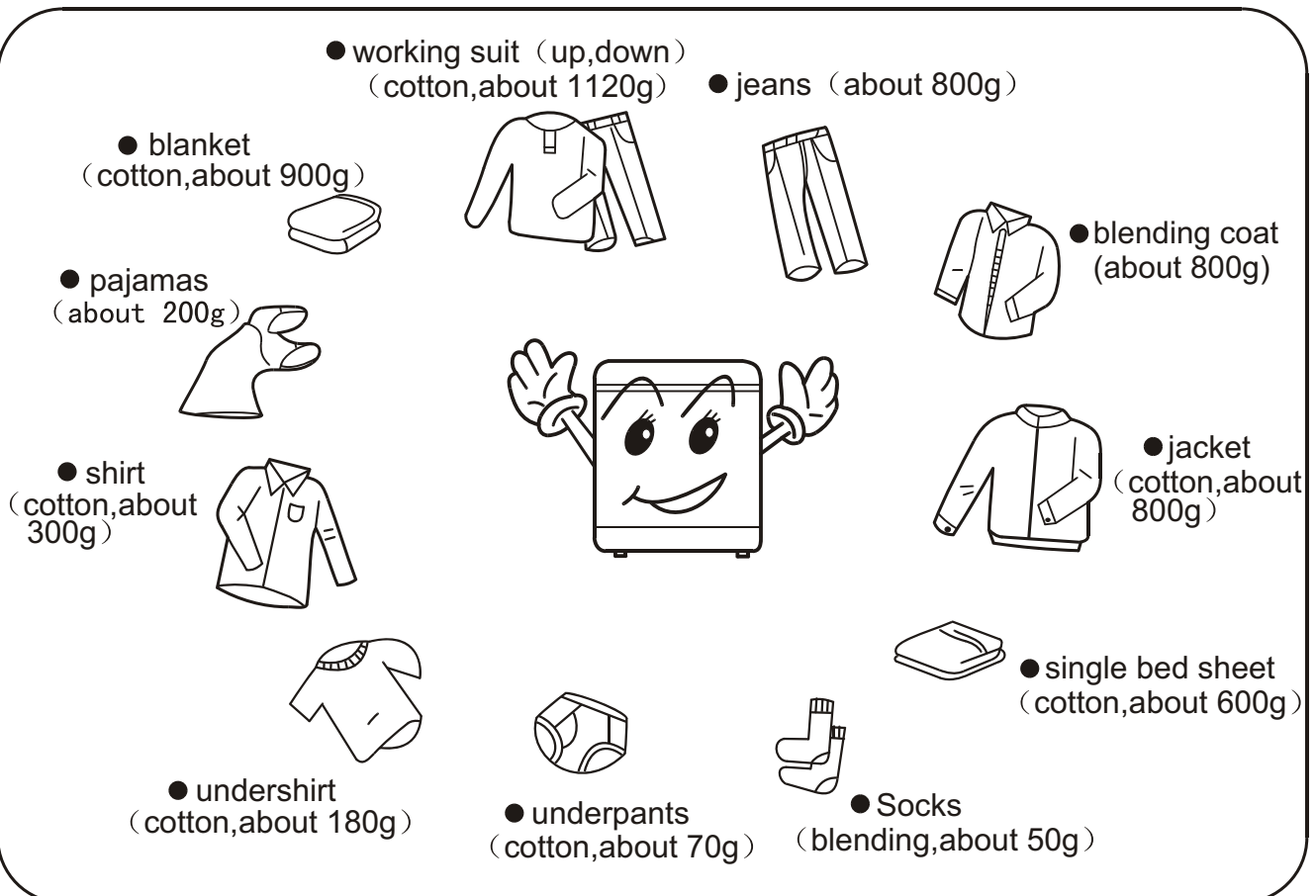

3 Put in the detergent

Using process

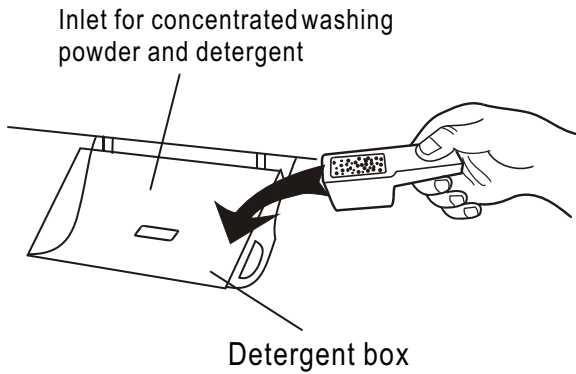

How to use the whitener

- Fill water to decided level. Dilute the whitener with container. Pour it slowly into the washing tub.
- Avoid using whitener on laundries with color or pattern as they are prone to lose color.
- The whitener shall not touch the laundries directly.
- Refer to the user's manual for the usage and quantity of the whitener.
- For powder whitener, please dissolve it before use.

How to use the washing powder

- Direct dissolved in the machine
 - 1.Fill water to "Low" water level.
 - 2.Add the power. Run for 30 seconds to dissolve it completely.
 - 3.Put in the laundries. Select suitable water level.
- The instant dissolving of the washing powder:
 - 1.Prepare warm water of 30°C and a container.
 - 2.Add the powder while stirring to fully dissolve it.
- Put in the prorer quantities detergent according to the water level and the laundries quantities .
- It is suggested not to use high sudsing detergent.
- Washing powder with poor quality or long time storage maybe caked. Please pay attention to cleaning the detergent box in time

Standard usage quantity of the detergent and water quantity

Laundries quantity(kg)	Water level	Water quantity	Common powder (Add 40g in each 30L water)	Concentrated powder (Add 25g in each 30L water)
Above 3.5	HIGH	About 48L	About 64g	About 40g
2.0~3.5	MEDIUM	About 37L	About 49g	About 36g
1.0~2.0	LOW	About 30L	About 40g	About 25g
Below 1.0	VERY LOW	About 20L	About 27g	About 17g

4 Use the operation buttons *Using process*

a. Description of the function of the buttons

SURPLUS(MIN)

- To indicate "--" during sensing.
- To indicate remaining min. During program running.
- To indicate remaining reserved time (hrs) during reservation period.
- To indicate fault symbols for abnormal conditions (see page 15)

Page 15

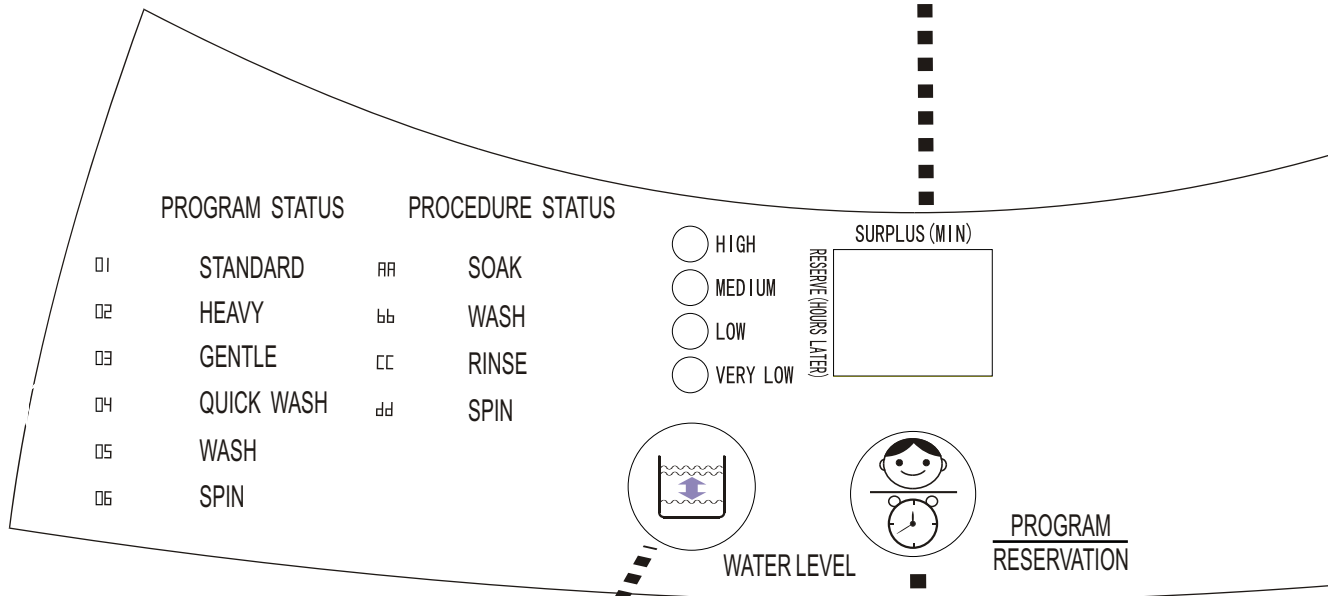

" WATER LEVEL "button

- The user selects a suitable water level depending on the load.

"PROGRAM/RESERVATION " button

- Press "PROGRAM/RESERVATION " button you can select one or several programs of Standard, Jeans, Gentle, Quick, Rinse and Spin.
- Press "PROGRAM/RESERVATION " button over 2 seconds, you can select the program of reservation. the Nixie tube displays the reserved hrs to the wash cycle end. The indicator flashes to indicate in-reservation.

"POWER ON/OFF"button

- Press "Power On/Off" button to connect power supply.
- After power is connected, pressing this button will cut off the supply.

"START/PAUSE"button

After the power is switched on, press it to start the machine

- During working, push it to pause working.
- During pause, push this button to restart and continue operation.

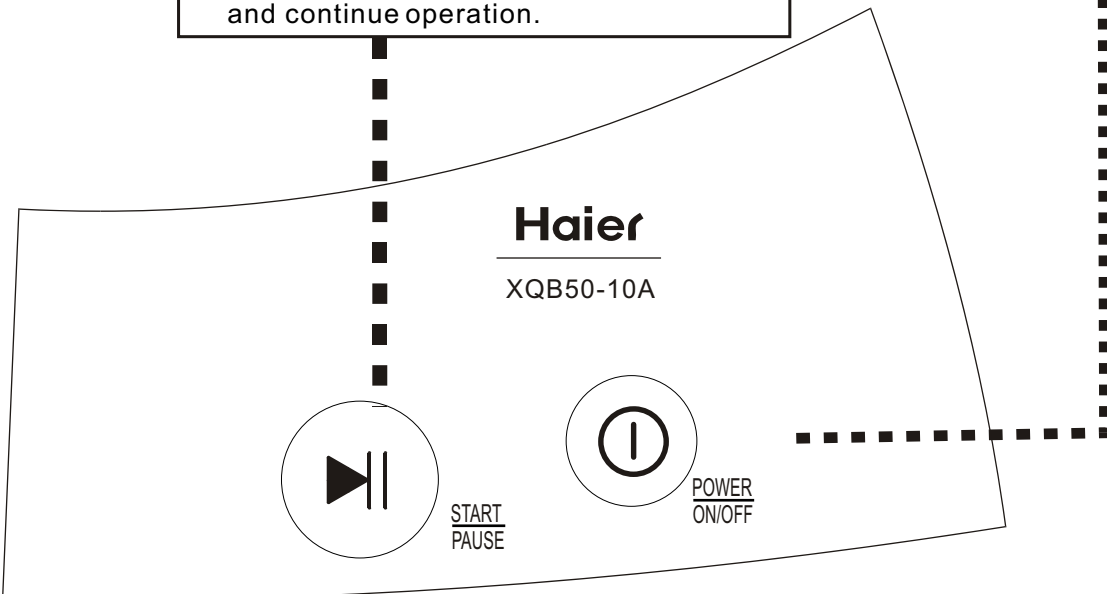

Remarks: After pressing "Power On/Off" to connect power supply, if the washing machine lasts idle more than 10 min, it would automatically shut off the supply.

b. Operating procedure and explanations for the buttons

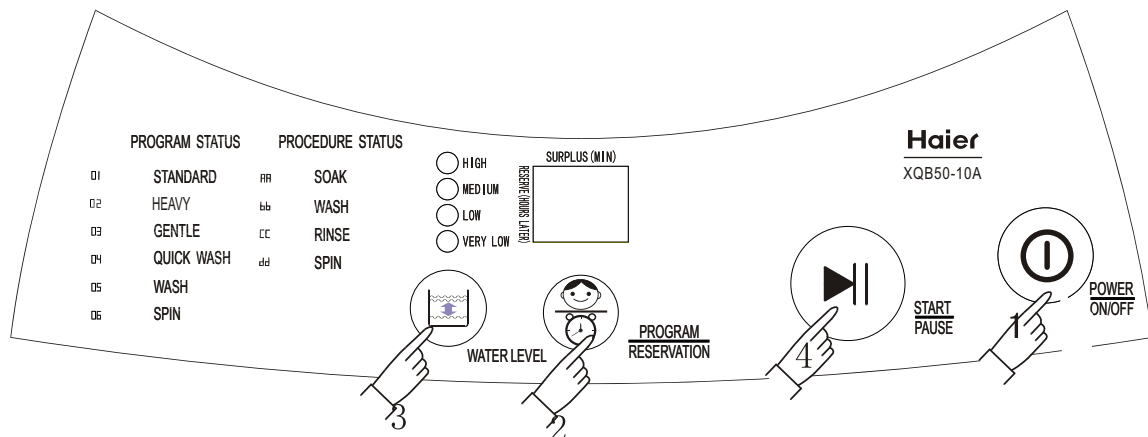

1 Press the "Power On/Off" button to switch on the power supply

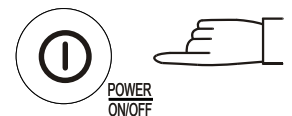

2 Press the button of "Program/Reservation" to select a suitable full-automatic program



After switching on, the "Standard" program will be the default. If other full-automatic program is desired, you can press the button "Program" to get the corresponding indicator on. Refer to the "Button of 'program'" paragraph on page 9.
 Example: Use the "Quick" program for slightly soiled articles.

Page 9

- When "standard" or "Jeans" program is selected, the washing machine will perform full-automatically controlled fuzzy program to set water level, water flow and wash duration according to the cloth nature and weight

Attention

- Even there's no water in the tub, the spinning will start after a certain period.
- Do not use soak process for woolen laundries.
- Wash the laundries that are prone to lose colors separately from other laundries. The pulsator will not rotate unless the
- water is filled to selected water level.

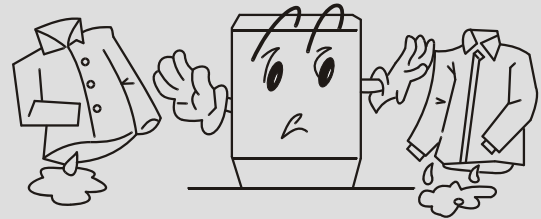

Selection method of the procedure programs

Times of pushing the "Program select" button	Corresponding program	Applicable procedure	Selected procedure program	Total Time
0	Standard	When the common laundries need washing rinse and spin	Wash(bb) Rinse(cc) Spin(dd)	About 39~44
1	JEANS	If the laundries are very dirty, or the sleeve and collar are dirty, first soak then wash	Soak(AA) Wash(bb) Rinse(cc) Spin(dd)	About 64~89
2	GENTLE	When the laundries needs to be washed carefully such as woolen textiles or underwear.	Wash(bb) Rinse(cc) Spin(dd)	About 34
3	QUICK WASH	When the laundries is lightly soiled that needs to be washed quickly.	Wash(bb) Rinse(cc) Spin(dd)	About 10
4	WASH	When the common laundries need only washing	Wash(bb)	About 13~18
5	SPIN	When the laundries need only spinning after manual washing (first drain then spin)	Spin(dd)	About 9

- If you push the "Process selector" button for 6 times, it will resume the original mode, and it will circulate like that.

Time list of each program (minute)

Program	Soak (min)	Wash (min)	Rinse (min)	Spin (min)	Total time(min)
Standard	/	About 11~16	Rinse twice, each about 3	About 6	About 39~44
Jeans	About 25~45	About 10~16	Rinse twice, each about 3	About 6	About 64~89
Gentle	/	About 6	Rinse once, about 2	About 6	About 34
Quick	/	About 3	Rinse twice, about 2	About 2	About 10
Wash	/	About 11~16	/	/	About 13~18
Spin	/	/	/	About 6	About 9

Using process

*Total time: including the normal water inlet time, drain time, excluding the power off time. The total washing time may be influenced by the water inlet pressure and water level.

*Spin time: the time from intermittent running to finishing.

*The Jeans program could combine the process of soak during which the washing machine firstly soak for about 25~45 min after water filling and then begins to wash.

*When "Quick wash" program is chosen, the washing machine would automatically set water level and full processes of wash, rinse and spin.

3 Press the "water level" button to select suitable water level



After switching on the power, press the button "Water level" to select a water level according to the load. Please refer to the paragraphs □Detergent standard dosages and water levels" and "Button of Water level" on page 9.

Page 9



4 Push the "Reservation" button to select suitable reserve program



After switching on, the washing machine reserved wash program will be automatically set inactive. If you desire a wash cycle to end at a reserved time, you can press the "Reservation" button to set a reserved wash program. Refer to "The button of Reservation" on page 9.

• Confirm the reserve program

Page 9

- When "Reservation" becomes active, the nixie tube displays the time to the end of the reserved wash cycle, and the indicator turns on.
- To change the running program or cancel the reservation, you should cut off the supply and reselect.



the washing will finish about 18 hours later

5 Press the "start/pause" button

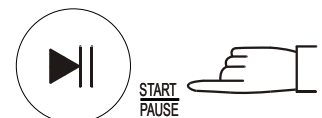

5 Close the top lid

When the machine working, if the top cover is opened, the washing machine will stop running and alarm.

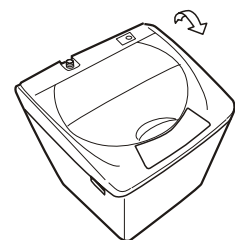

6 Finish washing

The washing machine cuts off the power supply automatically when wash cycle ends.



After Finishing wash alarm automatically

7 Disposal after washing

- After using, please clean the lint and foreign materials of the lint filter etc. in time. Otherwise it may influence your using the machine.
- Please first pull off the power plug from the receptacle before cleaning.

- When washing, lint filter must be used
- After using, please clean it in time.

Lint filter:

1. Pull upward to detach

2. Clean the lint

Put it in water and clean while it is still wet.
(See to Figure 1).

3. Press downward to assemble.

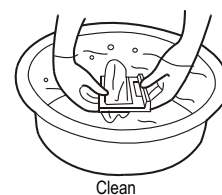

Figure 1

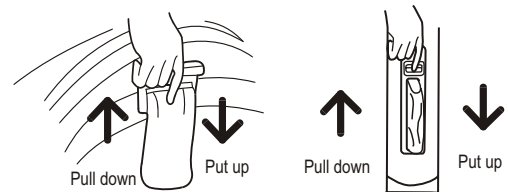
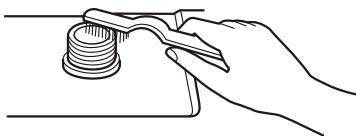

Figure 2

The filter screen of the water inlet valve is likely to be blocked by foreign materials and influence the water inlet. Please clean it with brush every two months.



If the cabinet is dirty, wipe it with wet cloth

- Do not flush it directly with water.
- Wipe it with neutral detergent.
- Do not wipe it with thinner, petrol, alcohol etc.

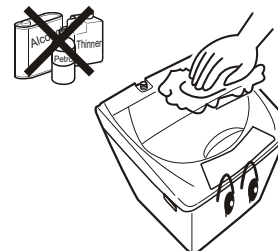

1. After washing, close the water faucet. (If needed, you can dismantle the water inlet hose).
2. Do not store water in the washing machine for a long period. Drain the water completely after each using.
3. Be sure to pull off the power plug before maintenance.
4. Hang up the power cord and drain hose.
5. Wipe off the water drops on the surface of the machine and inside the tub. Open the top lid for some time (about 1 hour), then close the top lid.

Trouble shooting • Answer to question

(If there's breakdown, please pull off the power plug before checking) The following phenomena are not breakdowns sometimes. Please confirm again before sending it to repair. If there are real breakdowns, please come to the special maintenance department. Do not repair it by yourself.

Phenomena		The reason	How to settle
Buzzing upon reservation starts, Nixie tube indicates "E0"		<ul style="list-style-type: none"> ● The top lid is not closed 	<ul style="list-style-type: none"> ● Close the top lid
No or slow drain, nixie tube indicates "E1", buzzing.		<ul style="list-style-type: none"> ● Is the drain hose put down? ● Is the drain hose blocked by foreign material? 	<ul style="list-style-type: none"> ● Put down the drain hose. Open and close the top lid once. ● Clean the foreign material. Open and close the top lid once.
Running pauses during spin, nixie tube indicates "E2", buzzing		<ul style="list-style-type: none"> ● The top cover leaves open 	<ul style="list-style-type: none"> ● Close the top lid
Safety switch actuates, not spin, (after self-correction twice), nixie tube displays "E3", buzzing		<ul style="list-style-type: none"> ● Are the laundries put slantingly? ● Is the machine slanting? 	<ul style="list-style-type: none"> ● Re-order the laundries. Close the top lid. ● Level the machine in right position. Open and close the top lid once.
No or slow water filling (not reaching the level in 15 min), nixie tube indicates "E4", buzzing		<ul style="list-style-type: none"> ● The water tap is not open ● The water inlet valve is blocked ● The water pressure is too low and the current is too small 	<ul style="list-style-type: none"> ● Open the water tap. Push the "Start/Pause" button. ● Clean the water inlet valve. Push the "Start/Pause" button. ● Wait for the normal water pressure before use.
The machine does not act	Not wash	<ul style="list-style-type: none"> ● Is there power failure? ● Is the power plug loose? ● Does the water level arrive at the set water level? 	<ul style="list-style-type: none"> ● Use it when the power is on. ● Insert the power plug tightly. ● Adjust to the set water level.
	Not spin	<ul style="list-style-type: none"> ● Is the power plug loose? ● Is the top lid closed? ● Are the laundries put orderly? 	<ul style="list-style-type: none"> ● Insert the power plug tightly. ● Close the top lid ● Put the laundries orderly.
There's abnormal sound inside the machine.		<ul style="list-style-type: none"> ● Is the machine slanting? ● Is there metal material inside the washing machine? ● Are the laundries slanting in spinning? 	<ul style="list-style-type: none"> ● Level the machine properly. ● Fasten the buttons and zipper ● Reorder the laundries. Close the top lid.
No water filling		<ul style="list-style-type: none"> ● Is the power plug loose? ● If the water faucet is turned on? ● If Power On/Off and Start/Pause are pressed? 	<ul style="list-style-type: none"> ● Insert the plug firmly ● Turn on the water faucet ● Press Power On/Off and Start/Pause
The machine does not act. (the indicators are off.)		<ul style="list-style-type: none"> ● Is there power failure? ● Is the power plug loose? 	<ul style="list-style-type: none"> ● Use it when the power is on. ● Insert the power plug tightly.

Common phenomena

Phenomena	Explanation
<ul style="list-style-type: none"> ● The spinning is intermittent when it starts. 	<ul style="list-style-type: none"> ● Balance the laundries to avoid slanting.
<ul style="list-style-type: none"> ● Push the "PROGRAM /RESERVATION" button to select "Spin", but it doesn't work. 	<ul style="list-style-type: none"> ● The program is setting the drain time. Some time is needed before it starts spinning.
<ul style="list-style-type: none"> ● There may be some water flowing out of the drain hose in the first use of the machine. 	<ul style="list-style-type: none"> ● It is the water remained in the factory inspection of performance.
<ul style="list-style-type: none"> ● While water filling in wash and rinse, the pulsator pauses rotation 	<ul style="list-style-type: none"> ● To prevent splash during water filling.
<ul style="list-style-type: none"> ● Wash pauses 	<ul style="list-style-type: none"> ● Supplementary water filling 48 s after sensor tests cloth material.

Packing list

Name	Quantity	Storage position
<ul style="list-style-type: none"> ● User's manual 	<ul style="list-style-type: none"> ● One 	<ul style="list-style-type: none"> ● Inside the document bag
<ul style="list-style-type: none"> ● Components of the water inlet hose 	<ul style="list-style-type: none"> ● One 	<ul style="list-style-type: none"> ● Inside the accessory bag
<ul style="list-style-type: none"> ● Bottom plate 	<ul style="list-style-type: none"> ● One 	<ul style="list-style-type: none"> ● Between the upper cushion of the washing machine package and the upper seal of the package carton
<ul style="list-style-type: none"> ● Drain hose 	<ul style="list-style-type: none"> ● One 	<ul style="list-style-type: none"> ● Inside the accessory bag
<ul style="list-style-type: none"> ● Drain hose support 	<ul style="list-style-type: none"> ● One 	<ul style="list-style-type: none"> ● Inside the accessory bag
<ul style="list-style-type: none"> ● Tapping screws ST4x16 	<ul style="list-style-type: none"> ● Eight 	<ul style="list-style-type: none"> ● Inside the accessory bag
<ul style="list-style-type: none"> ● Lint filter 	<ul style="list-style-type: none"> ● Two 	<ul style="list-style-type: none"> ● Inside the accessory bag
<ul style="list-style-type: none"> ● Automatic washing machine 	<ul style="list-style-type: none"> ● One 	

Specification

Model	XQB50-10A
Rated washing / spinning capacity	5.0kg
Water level/Water quantity (about)	Lowest/20L Low/30L Mid/37L High/48L
Max water consumption	About 144L (High water level; Standard program)
Water inlet pressure	0.03MPa-0.78MPa
Rated washing power	325W
Rated spinning power	285W
Weight	About 39kg
Dimension	L 510mm W 500mm H 882mm

Free Manuals Download Website

<http://myh66.com>

<http://usermanuals.us>

<http://www.somanuals.com>

<http://www.4manuals.cc>

<http://www.manual-lib.com>

<http://www.404manual.com>

<http://www.luxmanual.com>

<http://aubethermostatmanual.com>

Golf course search by state

<http://golfingnear.com>

Email search by domain

<http://emailbydomain.com>

Auto manuals search

<http://auto.somanuals.com>

TV manuals search

<http://tv.somanuals.com>