

XQB70-10



Full Automatic Washing Machine



- Please read this manual carefully before use.
- Please retain it attentively for future reference.
- Please check if the power receptacle is earthed reliably before usage to guarantee your safety.
- The manufacturer is not responsible for any risks occurred owing to disobey these stipulations.

Contents

Before using

Names of the parts.....the 2nd cover
 Safety precautions1
 Introduction of the special functions.....3
 Installation and adjustment3
 Install the water inlet hose.....5

Using process

Preparation before washing7
 Put in the laundries8
 Put in the detergent9
 Use the operation buttons10
 Close the top lid14
 Finish washing14
 Disposal after washing15

Trouble shooting • Answer to question.....16

Packing list17

Specification.....the back cover

Names of the parts

Before Using

Honourable users,

Thank you for choosing our products.

Our products integrate high-tech, precision, frontier science. To facilitate using it, please read this manual carefully and operate this machine according to it.

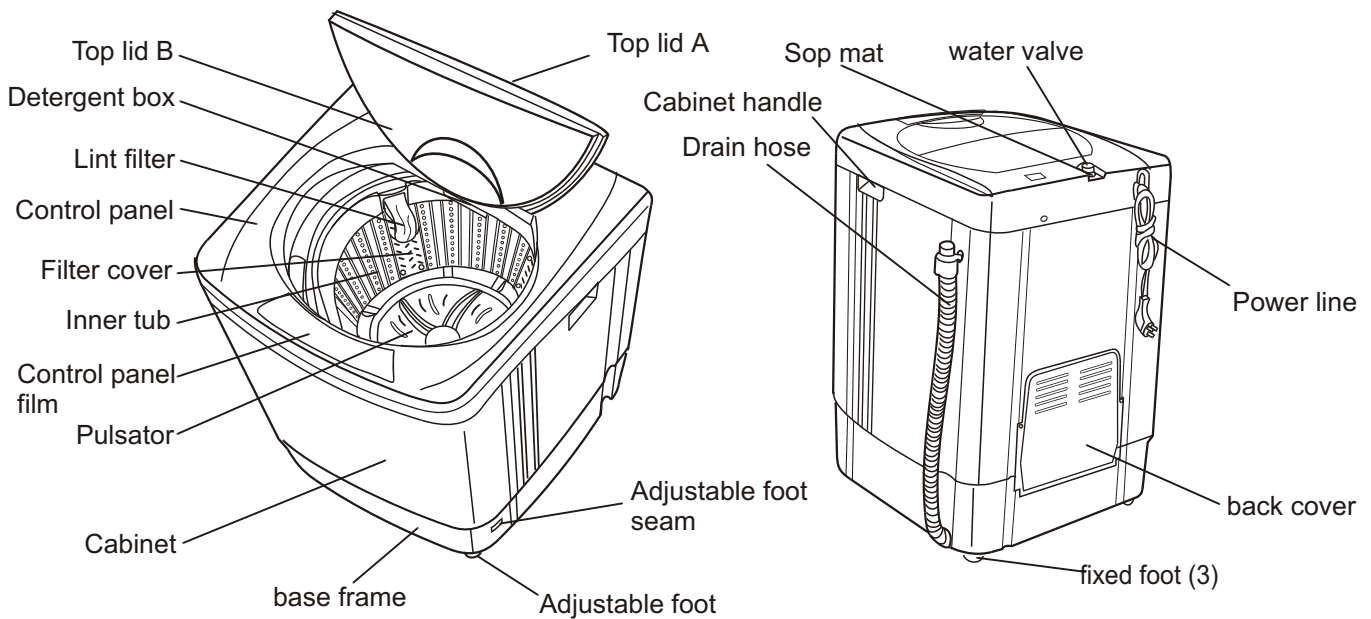

Accessories

	bottom plate (one)
	water inlet hose (one) Water inlet hose jointer (one)
	tapping screws ST4X16 (eight)

Meaning and description of the symbols

	Contents marked with that symbol are related to the safety of the product and the personal safety of the users. Please operate in strict conformity to the contents, otherwise it may cause damage of the machine or injure the personal safety of the user.
	Contents marked with that symbol are actions forbidden to perform. Performing of those actions may result in damage of the machine or injure the personal safety of the user.

Safety precautions

Before Using

Please insert the power cord into special receptacle with rated voltage. If the power cord is three-phase wire, please use three-phase receptacle. The earthing terminal of the receptacle must be earthed reliably. If it is two-phase wire, please guarantee that the earthing wire is earthed reliably. If possible, please adopt electric leakage protector.



The power cord plug should be convenient to be plugged in or plugged out with hand while the washing machine runs normally. Be sure to pull the plug out and close the water tap when the machine is idle, when moving the machine, or when cleaning the machine. Do not use wet hand to insert or pull out the power plug.

Do not damage the power cord, bend, extend, twist, bind or alter it by force. Do not press or nip it with weight. If the power cord or the power plug is bad, or the power plug becomes flexible, to avoid risk it is required to have it replaced by the technicians of our special shop or the after-sale service department. Keep the pin of the power plug clean, if the power plug is polluted with dust, please wipe with dry cloth carefully.

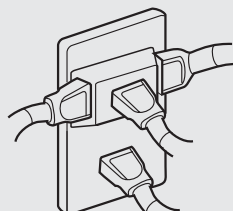
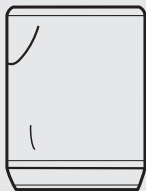

Before Using

Do not stretch hands into the working machine. It is dangerous even if the rotation is slow. Take special care of the children. Do not let the children climb the washing machine.



Do not decompose, repair or alter the machine by yourself.

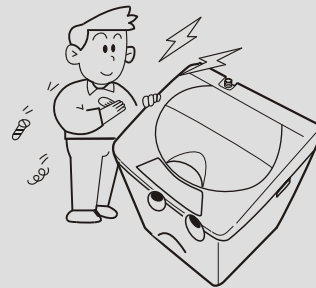

Do not put any hot or heavy items (such as the kettle with hot water) on the washing machine.



Do not wash laundries with volatile materials (such as thinner, petrol etc.)



The handicapped or children without care shall not use the machine.

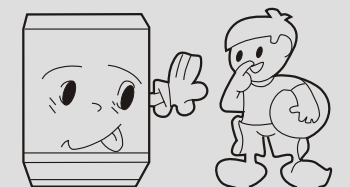

Keep the machine away from direct sunlight and heat source like the heater.

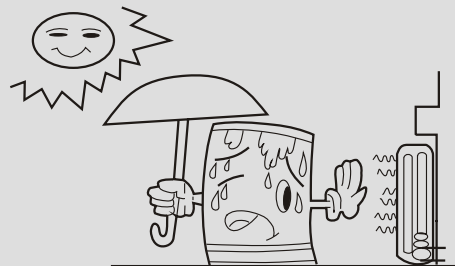

To prevent your laundries and washing machine from damage, be sure to take out all of the foreign materials from your pocket, such as coins, buttons, sand or hair pins etc.



- Before washing, please check if the water tap is open, and if the water inlet pipe is connected properly.
- It is suggested to use low-foaming washing powder

Please keep the lint filter in good condition, and install it to proper position. If the lint filter is lost or damaged, please contact the local after-sales service department of our company.

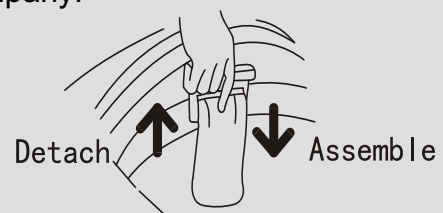

Special functions

Before Using

- "Hand scrub" wash:

The drum and pulsator rotate in opposite directions to form a washing water flow similar to hand scrubbing movement, and meanwhile the drum inner wall also take a share in washing, which obviously increase the washing intensity.

- Open-cover alarm function

During washing cycle except the processes of water filling and draining, the washing machine will stop operation and automatically alarm if the top cover is opened.

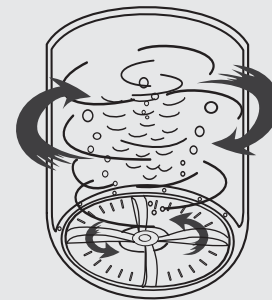

Installation and adjustment

Please install and adjust the machine according to the requirement of the manual. It is very important to your security and correct operating the machine.

Install the bottom plate

After you open the package, please lean the washing machine gently down on soft items (like the towel cloth, blanket, etc.). Install the bottom plate to the bottom of the machine with the eight screws by a cross screwdriver, then lift the machine up gently. See to the figure:

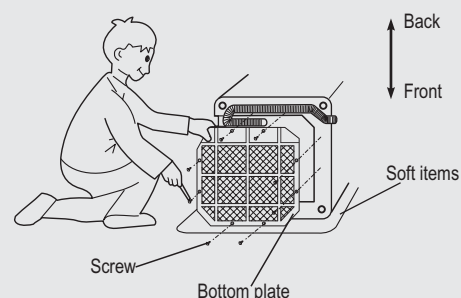

Adjust the installation position

The largest allowed slope of the shank base of the machine is 2° . The slanting or rough ground will result in unstable running or stoppage of the machine. Please adjust it with following methods:

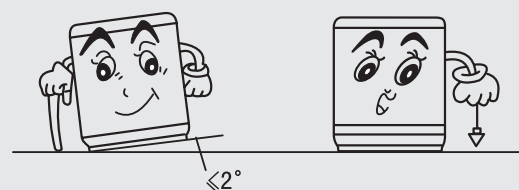

- **Adjust the adjustable foot:**

1. To twist the adjustable foot, please first lift up the side of the foot slightly, loosen the adjustable nut, and twist the foot.
2. Fasten the nut after adjustment.

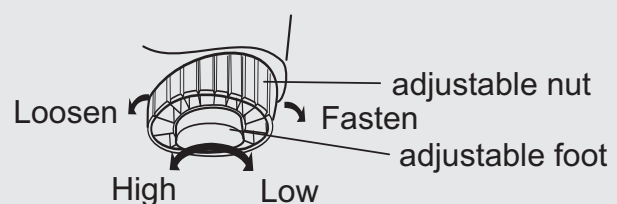

How to change the direction of the drain hose

1. Lean the machine down gently with the front surface facing the ground. Loosen the eight screws by a cross screwdriver.

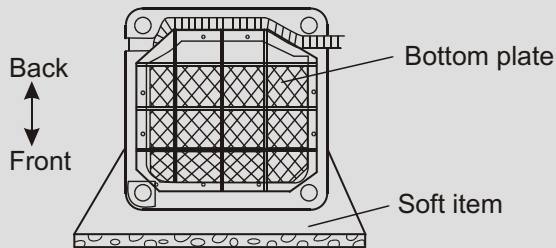

2. Pull out the drain hose from the groove at the right side.

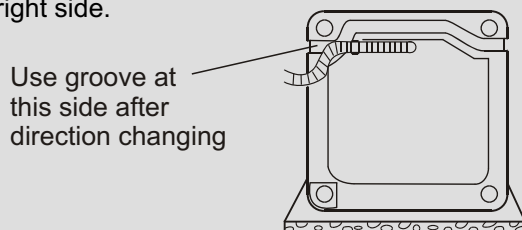

3. Extend the drain hose from the left side. Push the drain hose into the groove with hands.

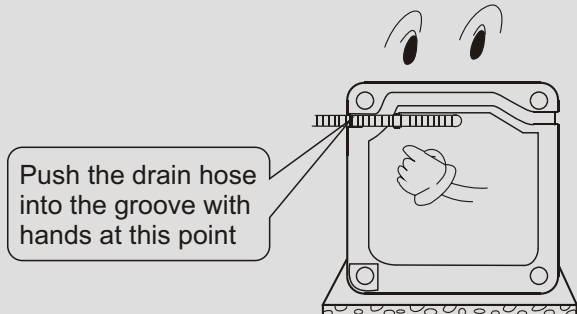

4. Install the bottom plate (as per indicated before), then lift the machine up gently.

Page 3

Usage of the drain hose

The drain hose shall drain smoothly

1. The height of the drain hose shall be less than 10cm, or the drainage will not be smooth, and cost such long time that the machine may stop at mid way.
2. Do not trample or press the drain hose.

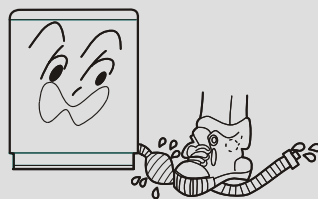
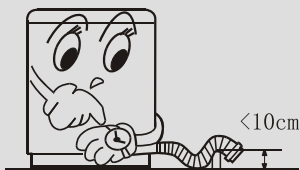

4. If extra drain hose is needed, please make separate purchase. The inner diameter of the extra hose shall not less than 26mm, and the length shall not exceed 1.5m.

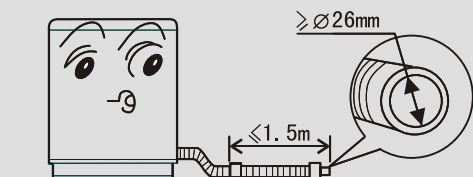

3. If the drain hose is too long, cut it at mid point. To make smooth drainage, cut the front end of the hose slantingly.

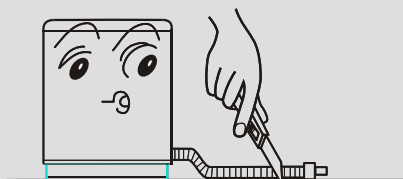

If the extra hose is too long, cut it either at A or at B point.

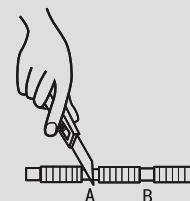

Install the water inlet hose

Before Using

Confirm the water tap

Water tap, suitable

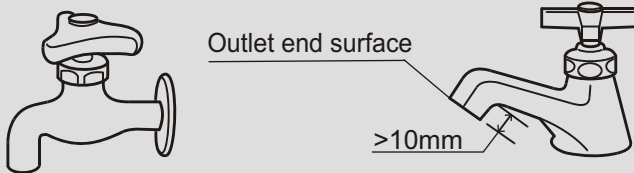

Water tap, not suitable

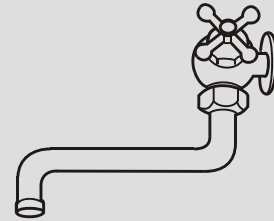

It is required that the front end shall be longer than 10mm. The outlet end surface of the tap shall be flat and smooth. If not please file it to avoid leakage.

Connection between the water inlet hose jointer and the water tap

1. Press the lower end of the lock lever and push down the slider. Take off the water inlet hose jointer from the water inlet hose component. See to Figure 1.
2. Loosen the screw till the water tap can be accessed. Put the jointer of the water inlet hose on the tap. See to Figure 2. (If the tap diameter is too large and the jointer can not be set on the water tap, please loosen the four screws and take out the bushing in the jointer. See to the figure3.)

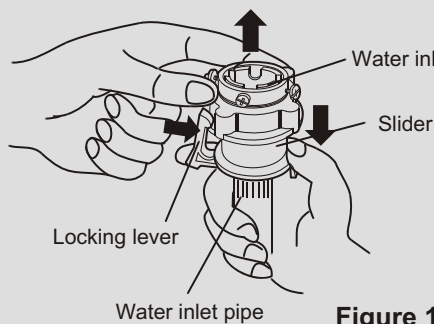

Figure 1

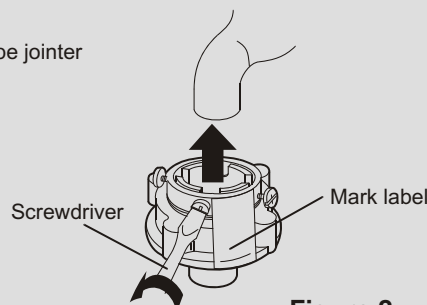

Figure 2

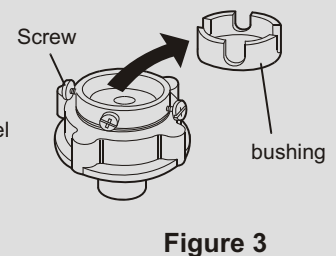

Figure 3

3. Fasten the four screws evenly. See to Figure 4.
4. Take off the nameplate. Twist the fastening nut as per the indication of the figure. See to Figure 5.

Remarks: Before twisting the fastening nut, the thread is 4mm above the upper surface of the nut. After twisting the fastening nut, the thread is 2mm above the upper surface of the nut. See to Figure 6.

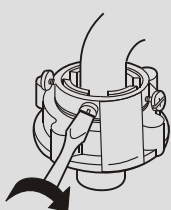

Figure 4

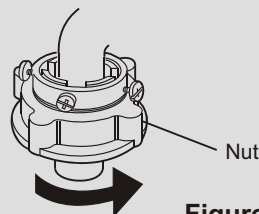

Figure 5

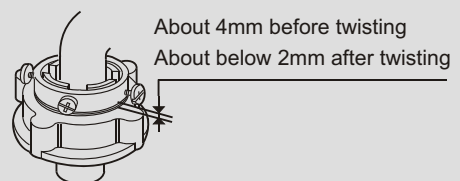
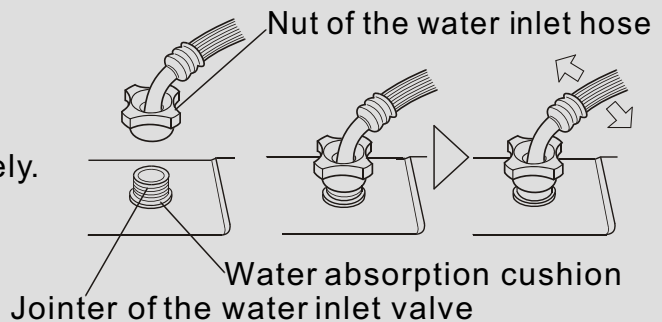

Figure 6

Connection between the water inlet hose and the washing machine

1. Do not take off the water absorption cushion. Please check if the cushion is dropped or damaged before each usage. If it happens please contact our after-sale department immediately.
2. Put the nut of the water inlet hose on the valve jointer.
3. Fasten the nut. Swaying it gently to confirm if it's suitable.



Connection between the jointer of the water inlet hose and the water inlet hose

1. Push down the slider. Insert the water inlet hose into the jointer.
2. Hang the lock lever to the jointer. Release the slider till a click sound is heard.

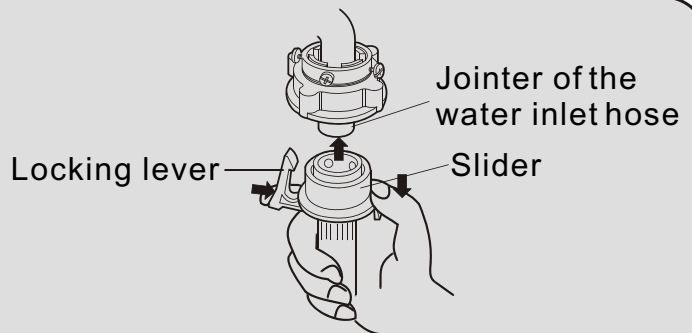

Check the connection between the jointer of the water inlet hose and the water tap

1. Swaying the hose gently to confirm if it is fastened stable.
2. After installation, open the tap to check if it leaks.
3. Do not bend the hose with overstrain.
4. Before each usage please check if the connection between the jointer of the water inlet hose and the water tap, and the installation of the water inlet hose are firm, so as to prevent dropping from improper

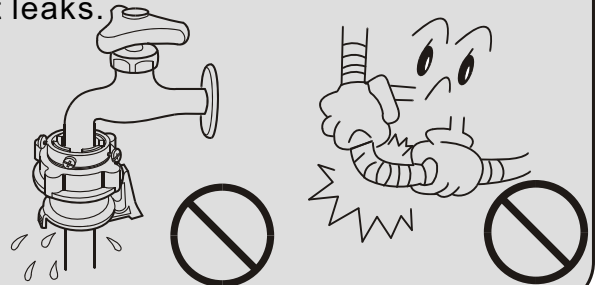

Take down the water inlet hose

1. Close the water tap.
2. Press the locking lever. Push down the slider. Then pull off the water inlet hose. If the machine is used more than once every week, the jointer of the water inlet hose can be kept on the tap to prevent damaging the fixing screw.

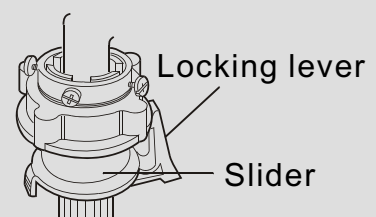

1 Preparation before washing *Using process*



Preparation before washing

1. Connect the water inlet hose and open the water tap .
2. Confirm that the washing machine is earthed reliably . Then insert the power plug into the receptacle. Do not connect the earth terminal to the gas pipe and tap water pipe.
3. Put down the drain hose.

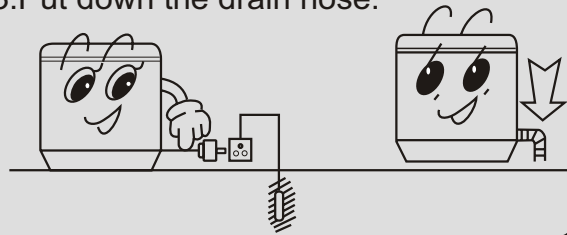

Pay attention to followings before washing the laundries

Confirm if there's special requirement for the laundries.

Clear the pocket. Take out the coins, sand, hairpins etc.

Fasten the buttons and zippers.

The quantity of the laundries shall not exceed the rated value. The big laundries like the jeans shall be put in loosely.

When the pulsator is running, the buttons of the laundries may cause noise. For the sake of discretion, please put the laundries with buttons into other laundries.



- a. Please check if the laundries are applicable for washing.
- b. Separate those not colorfast from other laundries.
- c. For laundries not waterabsorbing, please put them into water with hands.
- d. For laundries with much soil, please remove the soil first. You can add detergent on the part with serious soil directly. It is much easier to remove the soil by that mean.
- e. For laundries likely to get lint ball or with long fiber, please first turn the inside out before putting them into the water.
- f. Do not put the laundries polluted with chemicals directly into the washing machine.
- g. For those small laundries, laundries likely to be twisted or worn, and woolen laundries, please put them into mesh bag before wasing.

2 Put in the laundries

Using process



- The capacity of washing and spinning of the machine refer to the largest weight of the standard laundries under dry condition that can be washed or spinned in one time. One time washing quantity shall be lower than the rated capacity. The largest capacity of this machine is 7.0kg.
- The thickness, size, type of the cloth will influence the actual washing capacity. It is suitable for one time washing to put in reasonable amount of laundries and the laundries can be turned round in washing.
- Do not select "High" water level for laundries small than 1.0kg, so as to avoid splashing of water.
- To wash thin laundries like the stocking, silk etc., please first put them into washing mesh bag (which can be purchased separately) before wash.

Reference weight of the laundries:

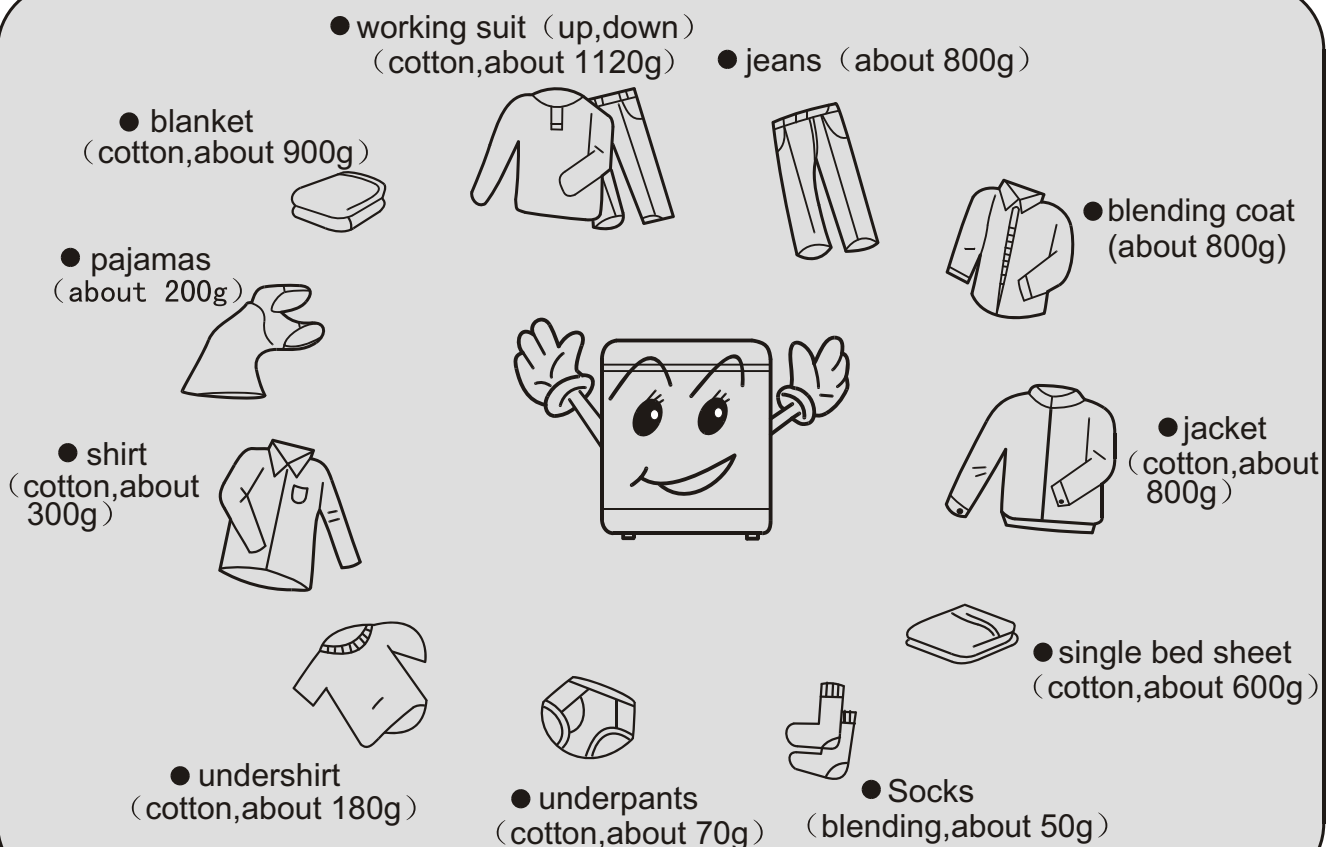

3 Put in the detergent

Using process

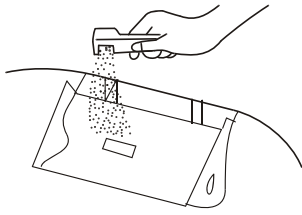

Inlet box of the detergent

How to use the whitener

- Fill water to decided level. Dilute the whitener with container. Pour it slowly into the washing tub.
- Avoid using whitener on laundries with color or pattern as they are prone to lose color.
- The whitener shall not touch the laundries directly.
- Refer to the user's manual for the usage and quantity of the whitener.
- For powder whitener, please dissolve it before use.

How to use the washing powder

- Direct dissolved in the machine
 - 1.Fill water to "Low" water level.
 - 2.Add the power. Run for 30 seconds to dissolve it completely.
 - 3.Put in the laundries. Select suitable water level.
- The instant dissolving of the washing powder:
 - 1.Prepare warm water of 30°C and a container.
 - 2.Add the powder while stirring to fully dissolve it.
- The powder is more prone to pollute the laundries than the detergent. Therefore please use it with proper quantity.
- It is suggested not to use high sudsing detergent.
- Different washing powders have different dosage. Please refer to the usage manual of the washing powder for the details.



Standard usage quantity of the detergent and water quantity

Laundries quantity(kg)	Water level	Water quantity	Common powder (Add 40g in each 30L water)	Concentrated powder (Add 25g in each 30L water)
Above 3.5	10 9	About 42L About 38L	About 56g About 50.5g	About 35g About 31.5g
2.5~3.5	8 7	About 35L About 33L	About 46.5g About 44g	About 29g About 27g
1.5~2.5	6 5	About 31L About 28L	About 41g About 37g	About 26g About 23g
0.5~1.5	4 3	About 26L About 23L	About 34.5g About 30.5g	About 22g About 19g
Below 0.5	2 1	About 18L About 15L	About 24g About 20g	About 15g About 12.5g

4 Use the operation buttons *Using process*

a. Description of the function of the buttons

Mode and meaning of the indicator light

-  : Flashing: indicate the running program
-  : On: indicate the program about to run, or indicate the selected mode
-  : Flashing rapidly: indicate abnormal condition

" Process select"button

- With it you can select one or several processes of soak, wash, rinse and spin.

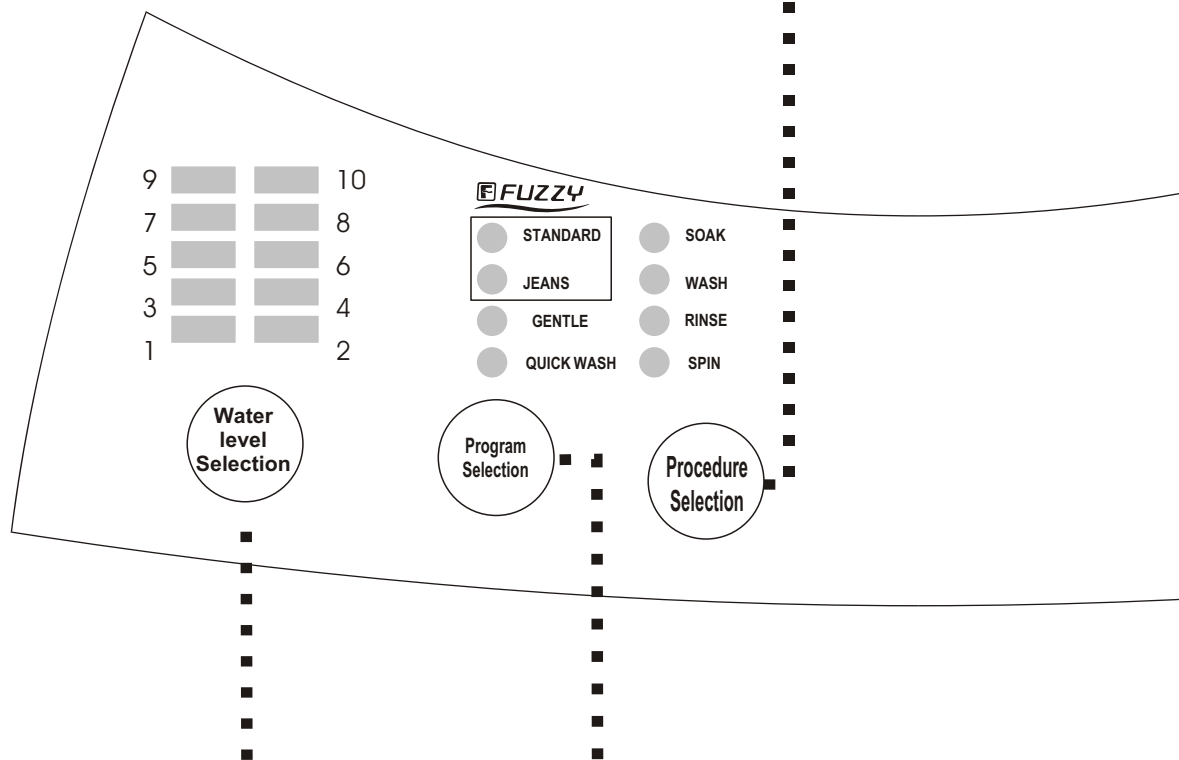

Water level button

- The user selects a suitable water level depending on the load.
- If "Quick" wash is selected, water level will indicate "2". After water level reaches "2", it will wash while water filling, and wash normally upon the water level reaching "4".
- After washing for 1 min, pressing "Water level" button will enable supplemental water filling, which will stop automatically upon the water reaching overflow level.

"Program select" button

- You can select from the following four programs.

Program	Standard	Normal wash
	Jeans	Large, thick or heavily soiled laundry
	Gentle	Woolen textiles or underwear
	Quick	10 min quick wash for load below 2 Kg

Using process

"Start/Pause"button

- After the power is switched on, press it to start the machine
- During working, push it to pause working.
 - During pause, push this button to restart and continue operation.

"Power On/Off"button

- Press "Power On/Off" button to connect power supply.
- After power is connected, pressing this button will cut off the supply.

Nixie tube

- To indicate "--" during sensing.
- To indicate remaining min. During program running.
- To indicate remaining reserved time (hrs) during reservation period.
- To indicate fault symbols for abnormal conditions (see page 16)

Page 16



Haier

XQB70-10

START
PAUSE

POWER
ON / OFF

Reservation

Button of Reservation

- The nixie tube displays the cycle remaining min, during running. tube display time left (minutes).
- Pressing the button, the nixie tube displays the reserved hrs to the wash cycle end. The indicator flashes to indicate in-reservation.

Remarks: After pressing "Power On/Off" to connect power supply, if the washing machine lasts idle more than 10 min, it would automatically shut off the supply.

b. Operating procedure and explanations for the buttons

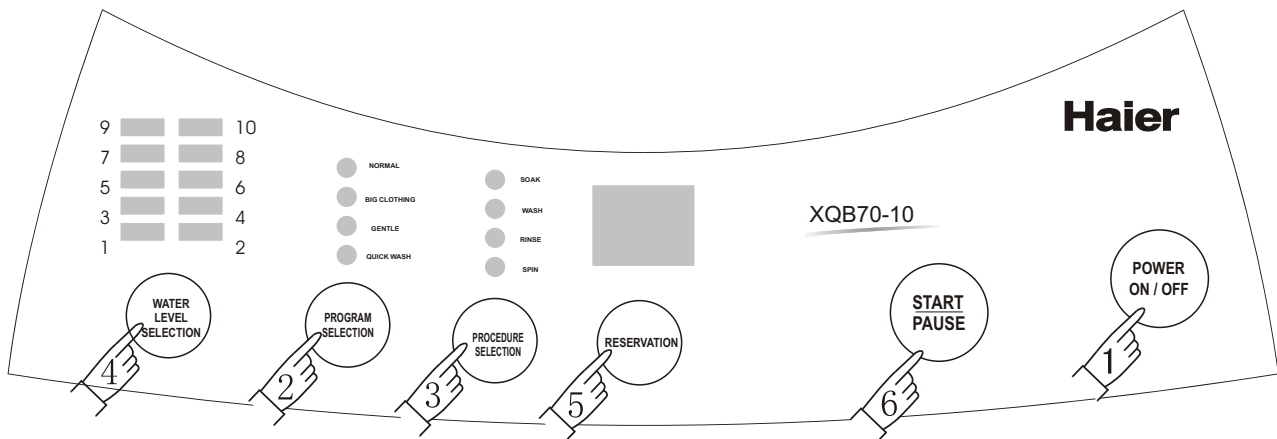

1 Press the "Power On/Off" button to switch on the power supply



2 Press the button of "Program Selection" to select a suitable full-automatic program

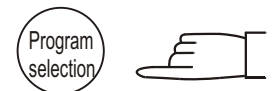

After switching on, the "Standard" program will be the default. If other full-automatic program is desired, you can press the button "Program" to get the corresponding indicator on. Refer to the "Button of 'program'" paragraph on page 10.

Example: Use the "Quick" program for slightly soiled articles.

Page 11



- When "standard" or "Jeans" program is selected, the washing machine will perform full-automatically controlled fuzzy program to set water level, water flow and wash duration according to the cloth nature and weight

3 Press the button of "process selection" to select suitable processes.



After the power is switched on, the washing machine will automatically set a normal program comprising of processes of "Wash, Rinse and Spin". If other program is desired, press the button of "Process" to select one or several process of soak, wash, rinse and spin. Refer to the paragraph "Processes selecting".

Page 14



Attention

- Even there's no water in the tub, the spinning will start after a certain period.
- Do not use soak process for woolen laundries.
- Wash the laundries that are prone to lose colors separately from other laundries. The pulsator will not rotate unless the
- water is filled to selected water level.

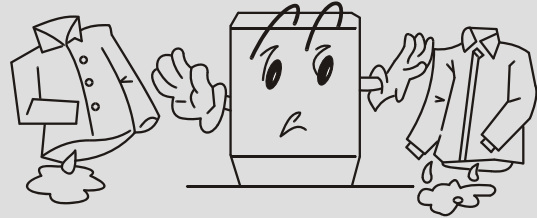

Selection method of the procedure programs

Times of pushing the "select" button	Selected procedure program	Applicable procedure	Contents (the lighted indicators indicate the programs about to run)
0	Wash, rinse, spin	When the common laundries need washing, rinsing and spinning.	Soak ● Wash ○ Rinse ○ Spin ○
1	Wash (the washing liquid remains in the tub)	Repeat using the washing liquid	Soak ● Wash ○ Rinse ● Spin ●
2	Wash, rinse (the rinsing liquid remains in the tub)	The laundry doesn't spin to avoid wrinkles	Soak ● Wash ○ Rinse ○ Spin ●
3	Rinse, spin	When the laundries need rinsing and spinning after manual washing	Soak ● Wash ● Rinse ○ Spin ○
4	Spin (spin after drain)	When the laundries need only spinning after manual washing (first drain then spin)	Soak ● Wash ● Rinse ● Spin ○
5	Soak, wash, rinse, spin	If the laundries are very dirty, or the sleeve and collar are dirty, first soak then wash	Soak ○ Wash ○ Rinse ○ Spin ○

- If you push the "Process selector" button for 6 times, it will resume the original mode, and it will circulate like that.
- If you select the "Speedy wash" program, you have to set the full procedure of wash, rinse and spin. The procedure can not be selected.

4 Press the "water level" button to select suitable water level



After switching on the power, press the button "Water level" to select a water level according to the load. Please refer to the paragraphs "Detergent standard dosages and water levels" and "Button of Water level" on page 10.

Page 9



Page 10



Using process

Time list of each program (minute)

Program	Water level	Wash (min)	Rinse (min)	Spin (min)	Total time(min)
Standard	1~10	13~15	Rinse twice, each about 4	About 6	About 35~47
Jeans	1~10	13~15	Rinse twice, each about 4	About 5.5~6.5	About 35~48
Gentle	About 4	About 3	Rinse once, about 4	About 2	About 10
Quick	1~10	About 3	Rinse twice, about 4	About 2	About 24

*Total time: including the normal water inlet time, drain time, excluding the power off time. The total washing time may be influenced by the water inlet pressure and water level.

*Spin time: the time from intermittent running to finishing.

*The Standard or Jeans program could combine the process of soak during which the washing machine firstly soak for about 15~45 min after water filling and then begins to wash.

*When "Quick wash" program is chosen, the washing machine would automatically set water level and full processes of wash, rinse and spin.

5 Push the "Reservation" button to select suitable reserve program



After switching on, the washing machine reserved wash program will be automatically set inactive. If you desire a wash cycle to end at a reserved time, you can press the "Reservation" button to set a reserved wash program. Refer to "The button of Reservation" on page 11.

• Confirm the reserve program

- When "Reservation" becomes active, the nixie tube displays the time to the end of the reserved wash cycle, and the indicator turns on.
- To change the running program or cancel the reservation, you should cut off the supply and reselect.



the washing will finish about 18 hours later

6 Press the "start/pause" button



5 Close the top lid

Except water filling and draining, if the top cover is opened, the washing machine will stop running and alarm.

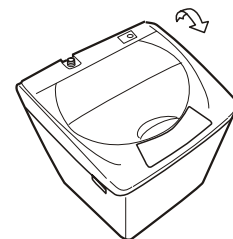

6 Finish washing

The washing machine cuts off the power supply automatically when wash cycle ends.



After Finishing wash alarm automatically

Using process

Time list of each program (minute)

Program	Water level	Wash (min)	Rinse (min)	Spin (min)	Total time(min)
Standard	1~10	13~15	Rinse twice, each about 4	About 6	About 35~47
Jeans	1~10	13~15	Rinse twice, each about 4	About 5.5~6.5	About 35~48
Gentle	About 4	About 3	Rinse once, about 4	About 2	About 10
Quick	1~10	About 3	Rinse twice, about 4	About 2	About 24

*Total time: including the normal water inlet time, drain time, excluding the power off time. The total washing time may be influenced by the water inlet pressure and water level.

*Spin time: the time from intermittent running to finishing.

*The Standard or Jeans program could combine the process of soak during which the washing machine firstly soak for about 15~45 min after water filling and then begins to wash.

*When "Quick wash" program is chosen, the washing machine would automatically set water level and full processes of wash, rinse and spin.

5 Push the "Reservation" button to select suitable reserve program



After switching on, the washing machine reserved wash program will be automatically set inactive. If you desire a wash cycle to end at a reserved time, you can press the "Reservation" button to set a reserved wash program. Refer to "The button of Reservation" on page 11.

- Confirm the reserve program
- When "Reservation" becomes active, the nixie tube displays the time to the end of the reserved wash cycle, and the indicator turns on.
- To change the running program or cancel the reservation, you should cut off the supply and reselect.



the washing will finish about 18 hours later

6 Press the "start/pause" button



5 Close the top lid

Except water filling and draining, if the top cover is opened, the washing machine will stop running and alarm.

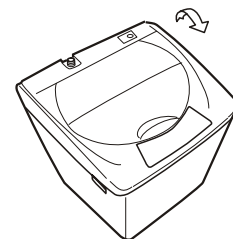

6 Finish washing

The washing machine cuts off the power supply automatically when wash cycle ends.



After Finishing wash alarm automatically

Trouble shooting • Answer to question

(If there's breakdown, please pull off the power plug before checking) The following phenomena are not breakdowns sometimes. Please confirm again before sending it to repair. If there are real breakdowns, please come to the special maintenance department or after-sale service department of our company. Do not repair it by yourself.

Phenomena		The reason	How to settle
Buzzing upon reservation starts, Nixie tube indicates "E0"		<ul style="list-style-type: none"> ● The top lid is not closed 	<ul style="list-style-type: none"> ● Close the top lid
No or slow drain, nixie tube indicates "E1", buzzing.		<ul style="list-style-type: none"> ● Is the drain hose put down? ● Is the drain hose blocked by foreign material? 	<ul style="list-style-type: none"> ● Put down the drain hose. Open and close the top lid once. ● Clean the foreign material. Open and close the top lid once.
Running pauses during spin, nixie tube indicates "E3", buzzing		<ul style="list-style-type: none"> ● The top cover leaves open 	<ul style="list-style-type: none"> ● Close the top lid
Safety switch actuates, not spin, (after self-correction twice), nixie tube displays "E3", buzzing		<ul style="list-style-type: none"> ● Are the laundries put slantingly? ● Is the machine slanting? 	<ul style="list-style-type: none"> ● Re-order the laundries. Close the top lid. ● Level the machine in right position. Open and close the top lid once.
No or slow water filling (not reaching the level in 15 min), nixie tube indicates "E4", buzzing		<ul style="list-style-type: none"> ● The water tap is not open ● The water inlet valve is blocked ● The water pressure is too low and the current is too small 	<ul style="list-style-type: none"> ● Open the water tap. Push the "Start/Pause" button. ● Clean the water inlet valve. Push the "Start/Pause" button. ● Wait for the normal water pressure before use.
Poor or no waterfall flow		<ul style="list-style-type: none"> ● If the nozzle is choked with foreign bodies 	<ul style="list-style-type: none"> ● Remove the foreign bodies
The machine does not act	Not wash	<ul style="list-style-type: none"> ● Is there power failure? ● Is the power plug loose? ● Does the water level arrive at the set water level? 	<ul style="list-style-type: none"> ● Use it when the power is on. ● Insert the power plug tightly. ● Adjust to the set water level.
	Not spin	<ul style="list-style-type: none"> ● Is the power plug loose? ● Is the top lid closed? ● Are the laundries put orderly? 	<ul style="list-style-type: none"> ● Insert the power plug tightly. ● Close the top lid ● Put the laundries orderly.
There's abnormal sound inside the machine		<ul style="list-style-type: none"> ● Is the machine slanting? ● Are the laundries slanting in spinning? 	<ul style="list-style-type: none"> ● Level the machine properly. ● Re-order the laundries.
The water faucet leaks		<ul style="list-style-type: none"> ● Is the jointer screw of the water inlet hose is loose or twisted away? 	<ul style="list-style-type: none"> ● Fasten the jointer screw properly.

Common phenomena

Phenomena	Explanation
<ul style="list-style-type: none"> The spinning is intermittent when it starts. 	<ul style="list-style-type: none"> Balance the laundries to avoid slanting.
<ul style="list-style-type: none"> Push the "Procedure selection" button to select "Spin", but it doesn't work. 	<ul style="list-style-type: none"> The program is setting the drain time. Some time is needed before it starts spinning.
<ul style="list-style-type: none"> There may be some water flowing out of the drain hose in the first use of the machine. 	<ul style="list-style-type: none"> It is the water remained in the factory inspection of performance.
<ul style="list-style-type: none"> While water filling in wash and rinse, the pulsator pauses rotation 	<ul style="list-style-type: none"> To prevent splash during water filling.
<ul style="list-style-type: none"> Wash pauses 	<ul style="list-style-type: none"> Supplementary water filling 48 s after sensor tests cloth material.

Packing list

Name	Quantity	Storage position
<ul style="list-style-type: none"> User's manual 	<ul style="list-style-type: none"> One 	<ul style="list-style-type: none"> Inside the document bag
<ul style="list-style-type: none"> Components of the water inlet hose 	<ul style="list-style-type: none"> One 	<ul style="list-style-type: none"> Inside the accessory bag
<ul style="list-style-type: none"> Bottom plate 	<ul style="list-style-type: none"> One 	<ul style="list-style-type: none"> Between the upper cushion of the washing machine package and the upper seal of the package carton
<ul style="list-style-type: none"> Tapping screws ST4x16 	<ul style="list-style-type: none"> Eight 	<ul style="list-style-type: none"> Inside the accessory bag
<ul style="list-style-type: none"> Automatic washing machine 	<ul style="list-style-type: none"> One 	

Specification

Model	XQB70-10
Rated voltage•frequency	220V~ • 50Hz
Rated washing / spinning capacity	7.0kg (weight of standard dry cloth)
Water level/Water quantity (about)	1/15L、2/18L、3/23L、4/26L、5/28L、 6/31L、7/33L、8/35L、9/38L、10/42L
Max water consumption	About 126L (High water level; Standard program)
Water inlet pressure	0.03MPa-0.78MPa
Rated washing power	350W
Rated spinning power	255W
Weight	About 26kg
Dimension	L 537mm W 520mm H 890mm

Free Manuals Download Website

<http://myh66.com>

<http://usermanuals.us>

<http://www.somanuals.com>

<http://www.4manuals.cc>

<http://www.manual-lib.com>

<http://www.404manual.com>

<http://www.luxmanual.com>

<http://aubethermostatmanual.com>

Golf course search by state

<http://golfingnear.com>

Email search by domain

<http://emailbydomain.com>

Auto manuals search

<http://auto.somanuals.com>

TV manuals search

<http://tv.somanuals.com>