

Haier

XQG50-600TXB

XQG50-600SW

Automatic Drum Washing Machine



Table of Contents

Before using

Names of Parts-----	inside front cover
Matters Needing Attention-----	1-3
Installation-----	4-5
Control Panel-----	6
Operational Functions-----	6-7

During using

Program Selection-----	8
Preparation-----	9
Washing Methods-----	10-11

Maintenance

Maintenance -----	12
Trouble Shooting-----	13
Technical Specification-----	14
Wiring Circuit-----	15

0020502333

Names of Parts

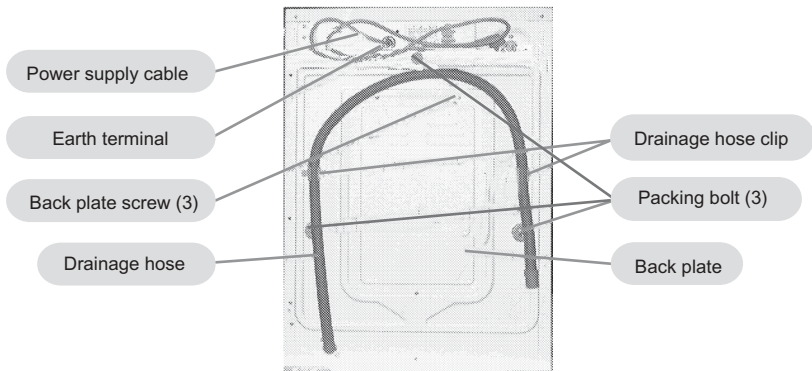
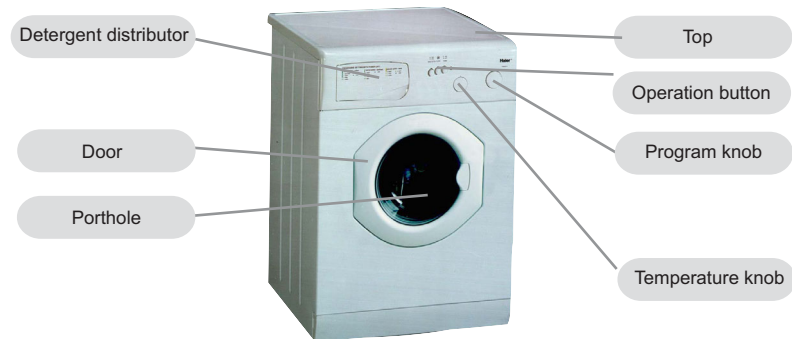

Caution and Warning symbols



For your safety, any instructions in this manual with this "Warning" sign shall be strictly followed.



For your safety and to prevent damages to the washing machine, any instructions in this manual with this "Stop" sign shall be strictly followed.

This diagram may vary slightly with the layout of the washing machine you have just purchased due to technical improvements.

Matters Needing Attention

● Safety

1. A separate earthed socket is required for the power supply. After installation of the washing machine, the power plug should be accessible during the normal wash.



2. Hold the plug and not the electric cable when unplugging the washing machine.



3. Fuses in the power circuit should be rated for 15A. Refer to a washing machine technician or a Haier designated service point for power cable replacement.

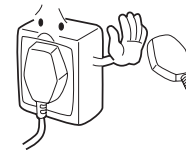

4. For your safety, dry hands before touching the washing machine and wear appropriate footwear.



5. Do not use flammable detergent or dry cleaning agent; do not use flammable spray in close vicinity to the washing machine; do not remove or insert the plug in the presence of flammable gas.

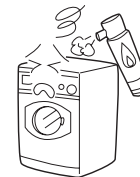

6. The door of the washing machine will become hot during the water heating process. Avoid contact with the door during the heating process. For safety, keep children away from the washing machine.



7. Do not allow children play with the packing materials after unpacking.

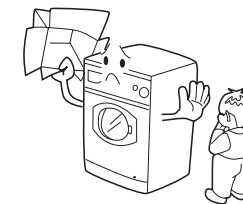

Matters Needing Attention

8. The washing machine must not be used in the open or in area of high moisture as water droplets may form on electrical components, Air dry the appliance if the washing machine components become wet.



9. The washing machine should be placed in a well ventilated area maintaining a space between walls or furniture.

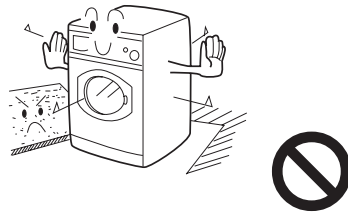

10. Keep away from heat sources and direct sunlight to prevent plastic and rubber components from aging.

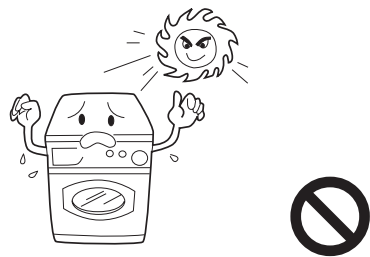

11. During installation, ensure that the electric cable is not trapped by the washing machine and avoid damage to the electric cable. Dear customer, For the machine and your own security, DO NOT REPAIR IT BY YOURSELF! DO NOT USE THE WASHING MACHINE WHICH SOME PARTS ARE LOST!

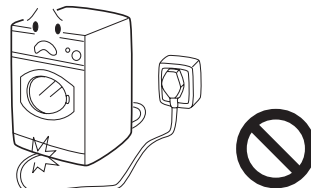

Use

1. Make sure that the washing machine is securely connected to the water supply, take the necessary precautions or contact the local service center if the connection is poor or there is a water leakage.



2. After turning the power off, turn the program knob clockwise to set washing program.

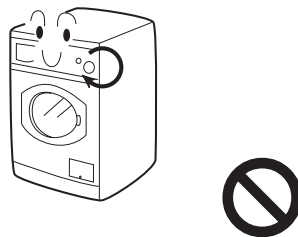

Wiring Circuit

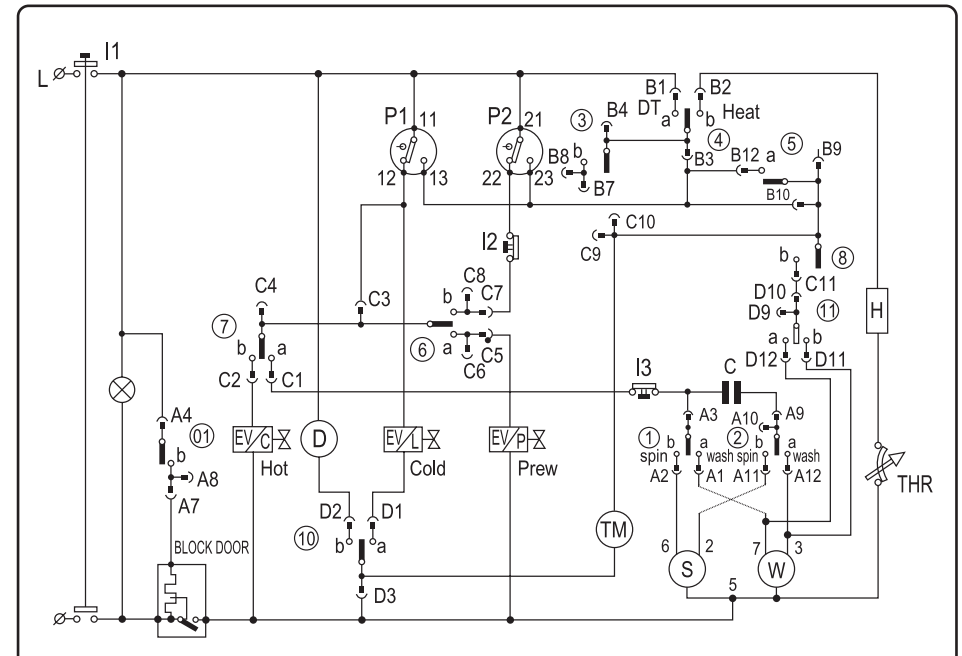

I1: Power Switch
 I2: Economic Wash Switch
 I3: No Spin Switch
 TM: Timer Motor
 H: Heating Element
 C: Capacitance

EVC: Hot Water Valve
 EVP, EVL: Cold Water Valve
 P1, P2: Pressure Switch
 THR: Adjustable Thermostat
 D: Drain Pump
 S, W: Motor

Technical Specification

Item	Model	XQG50-600TXB/XQG50-600SW
Power supply		220V~(50Hz)
Maximum working current (A)		10
Water pressure (MPa)		$0.05 \leq P \leq 1$ IPX4
Washing power (W)		330
Spinning power (W)		650
Max. washing load (kg)		5
Spinning speed (r/min)		600
Washing program		14
Heating power (W)		1950
Size (HxDxW) (mm)		850x550x595
Weight (kg)		76

Matters Needing Attention

3. Never place heavy objects ,a heating appliance or a water container on the top panel of the washing machine.



4. Do not wash foam rubber or similar sponge materials.



5. Before washing, do up zippers, buttons , laces and repair damaged areas, underwear or small articles should be placed in the laundry bag or a pillowslip.

Do not wash clothes containing wire frames.



6. Do not open the detergent box during the wash cycle.



7. The door is fitted with a self-lock device and will not open until 2~3 minutes after the washing machine stops. Do not force the door open. Do not open the door when water level reaches the port hole.



8. After washing, turn off the tap to prevent leakage; unplug the washing machine and wipe clean the lower part of the port hole.

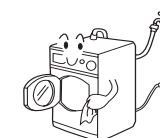

9. Keep the door slightly open when the washing machine is not being used. Never cover the machine with a plastic sheet.



Installation

- As shown in figure1 remove all the packing materials (including the foam base).

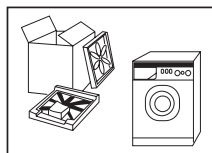

Fig 1

- Check attachments and materials.

Qty	Name	Operational manual	Quality certificate	Water hose	Drainage holder	Plastic plugs
	Model					
	XQG50-600TXB	1	1	2	1	3
	XQG50-600SW					

- Remove the packing screws as shown in figure 2.

The packing bolts protect the appliance from shock during transportation. The steps below should be followed before using the appliance,

1. Remove the rear panel of the washing machine;
 2. Remove the three packing bolts from the rear panel of the washing machine, the rubber hose and then the shock absorption channel steel;
 3. Reinstall the back plate;
 4. Fill the holes left by the packing bolts with plastic plugs.
- (Attention: the packing bolts and rubber hose should be kept in a safe place for later use)

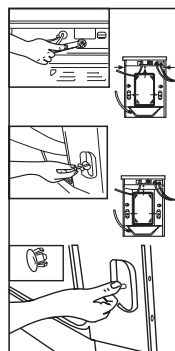

Fig 2

- Adjusting the position of the washing machine. There are adjustable feet under the bottom of the washing machine. Before use, the washing machine should be adjusted, as shown in figure 3, so that it is level.

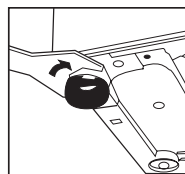

Fig 3

Trouble shooting

The following circumstances do not constitute problems. Do not contact the maintenance service until the problem has been confirmed.

Problem	Possible Cause
The washing machine fails to operate	<ul style="list-style-type: none"> ● Poor connection to power supply ● Power failure ● Door is not properly closed ● Machine has not been switched on
Washing machine does not fill with water	<ul style="list-style-type: none"> ● Water is not turned on ● Water pressure is less than 0.05MPa ● The inlet hose is kinked ● Water supply failure ● The program knob is not properly set ● The door is not properly closed
The water supply and drainage do not stop	<ul style="list-style-type: none"> ● Check that the height of the water hose is below 80cm
Drainage failure	<ul style="list-style-type: none"> ● Drainage hose is blocked ● Drainage hose end is over 100cm above the floor level
Strong vibration during spin	<ul style="list-style-type: none"> ● Some packing fixing bolts removed ● Washing machine on a uneven surface
Operation stops before completion of the wash cycle	<ul style="list-style-type: none"> ● Water or electricity failure
Excessive foam in the drum	<ul style="list-style-type: none"> ● The detergent is not a low foam type ● Excessive detergent has been used

Maintenance

1. Turn of the water and electricity supply after every wash. Open the door to prevent the formation of moisture and odors. If the washing machine is left idle for a long period, drain any remaining water in the machine and replace the drainage hose.

2. Unplug the machine during cleaning and maintenance. Use a soft cloth dampened with soapy liquid to clean the machine case and rubber components. Do not use corrosive or abrasive chemicals or solvents.

3. Clean the detergent compartment regularly. For the detergent compartment similar to figure (a), raise the compartment slightly to remove and replace after cleaning.

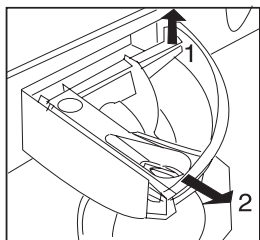

Fig (a)

4. Cleaning the Filter (once a month)

Press the lower edge of the filter compartment cover to open; (Fig1-2)
Remove the filter by turning counterclockwise; (Fig3)
Flash clean with running water;
Filter replacement is the reverse of removal. Caution: Attention shall be paid to ensure that the filter is replaced correctly to avoid possible leakage.

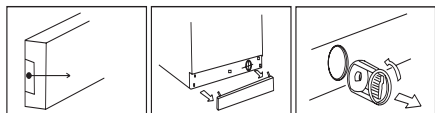
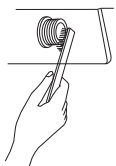

fig.1

fig.2

fig.3

5. To prevent blockages to the water supply or the ingress of contaminants, clean the water inlet and inlet water filter regularly.



6. If the machine is to be moved a distance location, replace the vibration mounting locks which were removed during installation as shown below.



Remove the back cover. Replace the rubber plugs. Insert the bolts.

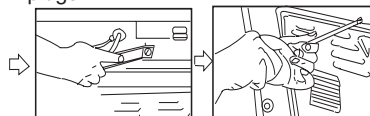

Tighten the bolts with a spanner.

Replace the back cover.

7. If the washing machine is left idle for a long period turn off the water and electricity supply and open the door slightly to prevent the formation of moisture and odors.

Installation

Connection of water inlet hose and washing machine

Water drainage hose

- The height of the terminal of the water drainage hose should be between 80cm-100cm, the water drainage hose must be securely placed on the clip on the back of the washing machine.
 - Use the water drainage support supplied as an accessory for proper installation of the water drainage hose .fix the water drainage hose support with waterproof string.Do not use an excessively long water drainage hose and contract the authorized technician if the water drainage hose needs to be extended.the water drainage hose should not be extended more than250cm.(longer extension will result in concurrent water inflow and outflow).The diameter of the extension hose should be the same as the original hose.
- caution:water drainage hose must not be immersed in water.the original and extension hoses should be tightly connected .

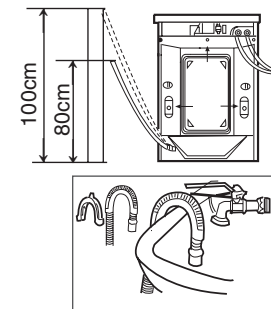

Connection of power supply

- Check the following items before connection to the power supply.
- The socket conforms to the maximum power load(The maximum current load of the socket and power supply cable should not be less than 15A).
 - Power supply voltage conforms to the required value.
 - The power supply socket and the plug of the washing machine compatible,if they are not compatible ,Refer to a washing machine technician or a Haier designated service point for power cable replacement.The washing machine should be connected to an earth before use.
 - Supplementary earth cable should not be necessary if the socket is connected to the earth.
 - Supplementary earth cable should be installed on the upper back of the washing machine andconnected to an earth if the power supply socket has no earth connection.

Control Panel

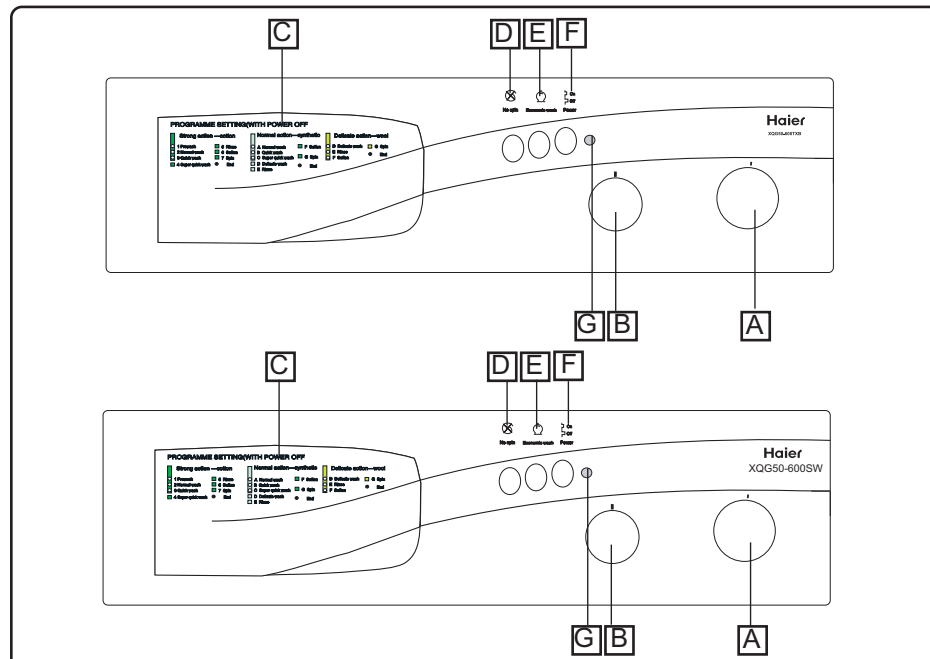

A Washing program

Turn the knob clockwise to set the desired wash program .
Caution: Turn off the power and turn the program knob clockwise for setting desired wash program.

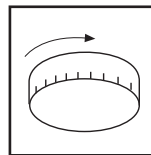

B Washing temperature

Turn the knob clockwise to set the desired temperature.
Temperatures between 30°C-90°C can be setted , No heating wash is selected when the knob is set at *.

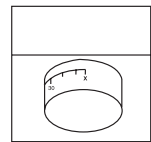

C Detergent distributor

Program discription are printed on the handle of the detergent distributor,there are three detergent compartments numbered 1,2,3
Box 1: Pre-washing detergent
Box 2: Standard washing - extra-fast washing
Box 3: Softening agent, adjusting agent, perfume

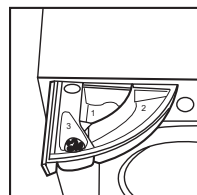

Washing Methods

4. Washing temperature Setting

Set the washing temperature as required, otherwise, set at position * when heating is not needed.

5. Selecting the function button

Select function buttons as required (refer to the directions printed on the control panel) , otherwise keep all the button released.

6. Washing

Press the power button and the washing machine will automatically commence the programmed washing process.

7. End

Wait 2-3 minutes after the washing process is finished, press the power button again to cut off the power supply. Open the door to take out the laundry. Turn off the tap and unplug the washing machine.

Additional information

Energy and water saving during wash process

1. Collect clothes for one full wash load.
2. Do not overload the washing machine.
3. Pre-wash heavily soiled clothes.
4. Reduce the amount of detergent or choose fast or minimal washing programs for lightly soiled clothes dirty.
5. Choose a proper washing temperature. Only exceed 60 °C for heavily soiled clothes.
6. Do not use more detergent than required.
7. Softening agent makes clothes feel softer and easier to iron.

Washing Methods

1. Laundry loading

Evenly load the laundry in the washing machine and then tightly close the door of the washing machine

Note: 1) When first using the washing machine, let it run unloaded for one program to prevent the laundry from being tainted by oil or dirty water from the washing machine. 2) Do not overload the washing machine.



Reference loading

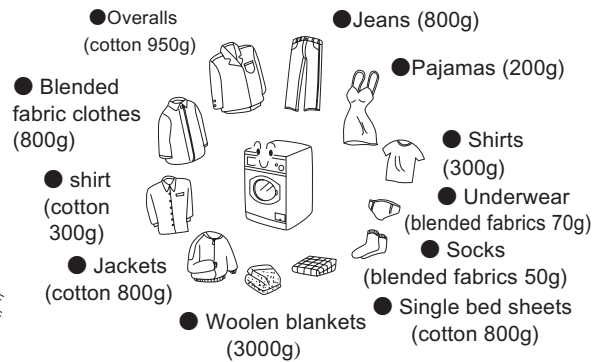

2. Use of detergent

Pull out the detergent drawer, put required detergent, softening agent and bleaching agent into the corresponding boxes. Push back the drawer gently.

Caution: 1) Do not add liquid detergent into box 1 and 2
2) For pre-washing program, detergent should be added to both box 1 and 2; for other programs, do not add detergent to box 1
3) Do not overuse softening agent as this may damage artificial fabrics.

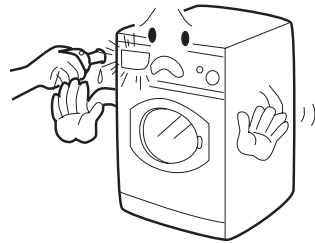

3. Washing program setting

Set the wash program correctly in accordance with the laundry load. The methods for setting wash programs are indicated on the handle of the distributor on the washing machine. Turn the program knob clockwise to the desired program.

Caution: Turn off the power before setting the wash program.

Operational Functions

D No spin button

When this button is pressed, the spin cycle will be spared but water drain is still available. This function is useful for hard ironing fabrics, such as chemical fiber and wool fabrics.



E Economic wash button

Pressing this button will reduce the consumption of water during bleaching under intense wash. It is recommended that this program be used when doing a small laundry load. Do not forget to reduce the amount of detergent used.



F Power button

Press the button, washing machine will working; release the button, the washing machine will stop.

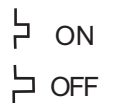

G Power light

The light will illuminate when the power supply is connected.



Program Selection

Program Setting		Laundry	Program time	Detergent			Note	
				Comp.1 prewash detergent.	Comp.2 deter- gent	Comp. 3 softener.		
Cotton cycle	1	Prewash	Heavy soil	15min.	★	★	○	
	2	Normal wash	Soiled cotton	20min.	×	★	○	
	3	Quick wash	Non-fade and medium soiled cotton	20min.	×	★	○	
	4	Super quick wash	Fading and medium soiled cotton	45min.	×	★	○	
	5	Rinse		22.5min.	×	×	○	Capable of separate rinsing
	6	Soften	Capable of softening if softener added	5min.	×	×	○	Capable of softening only
	7	Spin		12.5min.	×	×	×	Capable of spinning only
	•	End	Strong wash program ends and the machine stops operation.					
Synthetic cycle	A	Normal wash	Non-fade heavily soiled chemical fiber	5min.	×	★	○	
	B	Quick wash	Non-fade and medium soiled chemical fiber	10min.	×	★	○	
	C	Super quick wash	Fading and medium soiled chemical fiber	5min.	×	★	○	
	D	Delicate wash	Woolen fabrics	25min.	×	★	○	
	E	Rinse		10min.	×	×	○	Capable of separate rinsing
	F	Soften	Capable of softening if softener added	7.5min.	×	×	○	Capable of softening only
	G	Spin		7.5min.	×	×	×	Capable of spinning only
	•	End	Normal wash program ends and the washing machine stops operation.					
Wool cycle	D	Delicate wash	Woolen fabrics	25min.	×	★	○	
	E	Rinse		10min.	×	×	○	Capable of separate rinsing
	F	Soften	Capable of softening if softener added	7.5min.	×	×	○	Capable of softening only
	G	Spin		7.5min.	×	×	×	Capable of spinning only
	•	End	Delicate wash program ends and the washing machine stops operation.					

NOTE: "○" means softener liquid detergent can be added when necessary.

"★" means detergent can be added when necessary.

"×" means no detergent can be added.

Preparation

1. Power supply

Plug in the power supply 220V~/50Hz.



2. Water supply

Turn on the tap ensure that the water is clear.

Caution: Before starting the washing machine turn on the water faucet to ensure that the water faucet and the water inlet hose are connected correctly and do not leak.

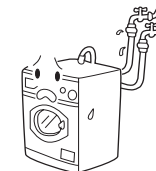

4. Detergent selection

Only special low foam detergent should be used in automatic drum washing machine, form blended or wool fabrics special detergent should be used. dry cleaning solvent should not be used such as trichloroethylene or alike (caution :load the required amount of detergent only).

3. Laundry treatment

● sort out clothes according to type and extent of dirt. There are three types of clothes: cotton, synthetical and woolen (silk) fabrics.

● separate white clothes from colored. If whites and coloreds are combined for one load, make sure the coloreds are colorfast.

-Remove all objects from pockets that may cause damage to the machine, such as keys and coins.

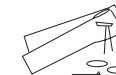

-Clothing with frayed edges or yarns should be put in a wash bag or special bag before washing.

-Repair damaged clothing, lose buttons or damaged zips and hooks before washing.

-Bed sheets and table ware should be loosely loaded and not folded.

● This washing machine is for household use and designed for mechanically washable clothes. When washing, separate unwashable clothes with reference to clothes labels.

5. Wash Load

Type	non-fade cottons	Delicat fabrics	Woolen fabrics	Blending fabrics
Max load	5kg	2kg	1kg	2.5kg

Free Manuals Download Website

<http://myh66.com>

<http://usermanuals.us>

<http://www.somanuals.com>

<http://www.4manuals.cc>

<http://www.manual-lib.com>

<http://www.404manual.com>

<http://www.luxmanual.com>

<http://aubethermostatmanual.com>

Golf course search by state

<http://golfingnear.com>

Email search by domain

<http://emailbydomain.com>

Auto manuals search

<http://auto.somanuals.com>

TV manuals search

<http://tv.somanuals.com>