

## Technica specifications

Item	Model	XQG50-S1016
Main power		220V~/50Hz
Max working current(A)		10
Water pressure(MPa)		$0.05 \leq P \leq 1$
Washing power(W)		300
Spining power(W)		700
Washing capcity(Kg)		5
Spinning speed(rpm)		1000/800/600
Drying power(W)		1000
Size(high,depth,width)mm		850 × 550 × 595
Weight(Kg)		78

## Operation Manual

# Haier

Automatic Drum Washing Machine

XQG50-S1016

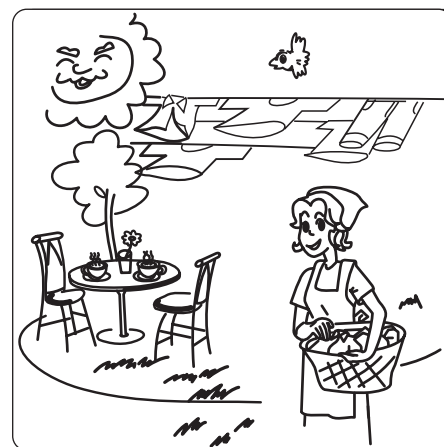

### Table of Contents

#### Before using

Names of parts-----	inside front cover
Matters needing attention-----	1-3
Installation-----	4-5
Control panel-----	6
Operational functions-----	6-7

#### During using

Program selection-----	8-9
Preparations-----	10
Washing methods-----	11
Additional information-----	12

#### Maintenance

Maintenance-----	13
Warning code-----	14
Trouble shooting-----	15
Warning-----	16
Wiring circuit-----	17
Technical specification-----	Back cover

## Names of parts

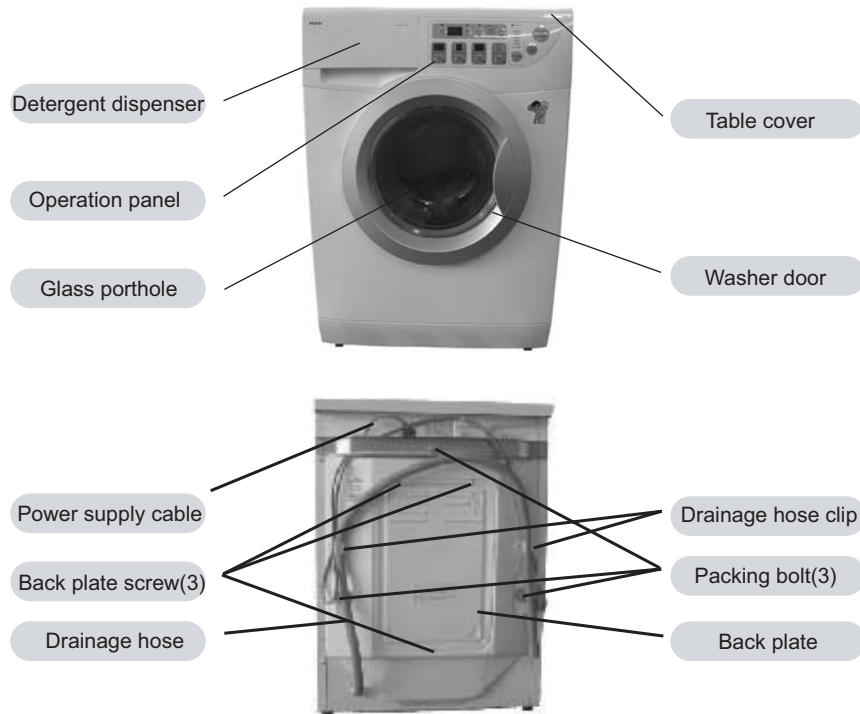

## Electronic system diagram

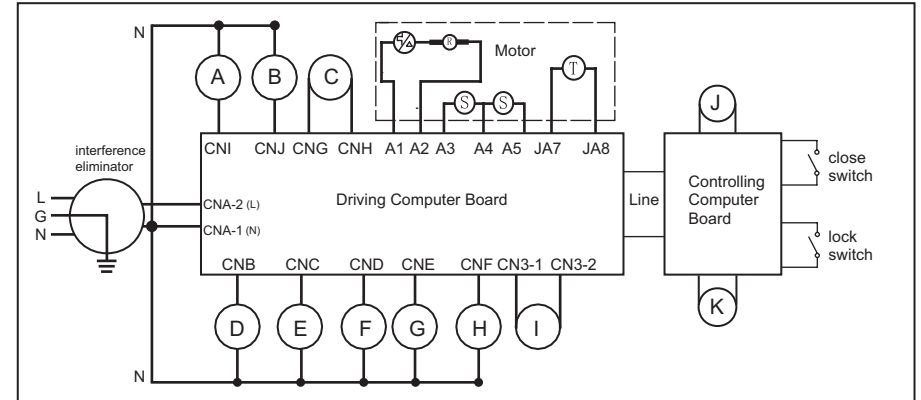

A:heater1 B:heater2(for drying) C:door engine(Micro-delay door switch)  
 D:water inlet electromagnetic valve for pre-washing G:pump H: drying fan motor  
 E:water inlet electromagnetic valve for main washing I:water level sensor  
 F:water inlet electromagnetic valve for drying J:water temperature sensor  
 K:drying temperature sensor

## Caution and warning symbols



For your safety, any instructions in this manual with this "Warning" sign must be followed strictly.



For your safety and to prevent damage to the washing machine, any instructions in this manual with this "Stop" sign must be followed strictly.

This diagram may vary slightly with the layout of the washing machine you have just purchased due to technical improvements.

## Warning

1.If the supply cord is damaged, it must be replaced by a special cord or assembly available from the manufacturer or its service agent.

2.If a stationary appliance is provided, with a supply cord and a plug, the instructions shall state that the appliance must be positioned so that the plug is accessible.

Note: this requirement does not apply if the appliance incorporates other means for disconnection from the supply.

3.For washing machines with ventilation opening in the base, do not place directly on carpet as it will obstruct the openings.

4.The instructions shall state that the appliance is to be connected to the water mains using new hose-sets and that old-sets should not be reused.

Note: these instructions are not required if the hoses are permanently attached to the appliance.

5.When connecting the washing machine for water supply and drainage, make sure the plug is within reach.

6.Keep the vent outlet at the bottom of the washing machine free from being blocked.

7.To prevent danger, damaged electrical cables must be replaced by the manufacturer or an authorised service agent.

## Matters needing attention

### ● Safety

1. A separate earthed socket is required for the power supply. After installation of the washing machine the power plug must be accessible during normal operation.

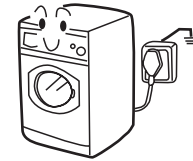

2. Pull the plug and not the electric cable when unplugging the washing machine.

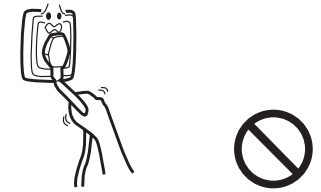

3. Fuses in the power circuit should be rated for 15A. Contact a washing machine technician or a designated service point for power cable replacement.

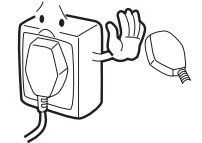

4. For your safety, dry your hands before touching the washing machine and wear appropriate footwear.



5. Do not use flammable detergents or dry cleaning agents; do not use flammable sprays near the washing machine; do not remove or insert the plug in the presence of flammable gas.

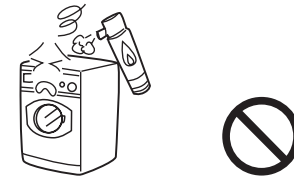

6. The door of the washing machine becomes hot during the water heating or drying process. Avoid contact with the door during the heating or drying process. For safety, keep children away from the washing machine.



7. Do not allow children to play with the packing materials after unpacking.

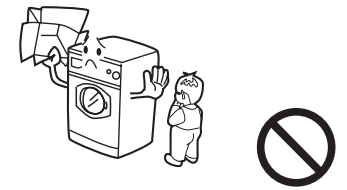

## Matters needing attention

8. The washing machine must not be used in the open or in an area of high humidity as water droplets may form on the electrical components. Air dry the appliance if the washing machine components become wet.

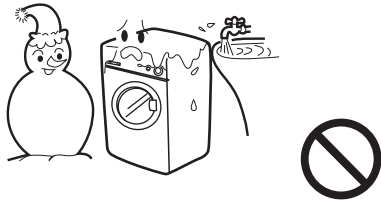

9. The washing machine should be placed in a well-ventilated area, leaving a space between the appliance and adjacent walls or furniture.

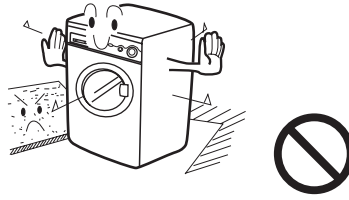

10. Keep away from heat sources and direct sunlight to prevent plastic and rubber components from ageing.

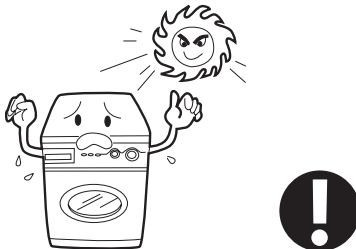

11. During installation, ensure that the electric cable is not trapped by the washing machine and damaged. Dear customer, For the machine and your own security, DO NOT REPAIR IT BY YOURSELF! DO NOT USE THE WASHING MACHINE WHICH SOME PARTS ARE LOST!

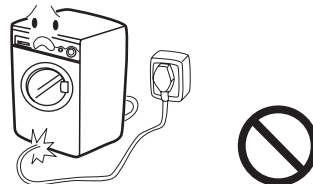

### • Use

1. Make sure that the washing machine is securely connected to the water supply. Take the necessary precautions or contact the local service centre if the connection is poor or there is a water leak.

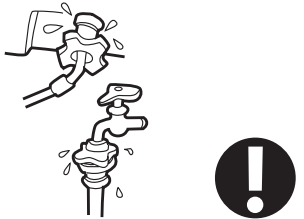

2. Fasten the door handle before opening the door and then close the porthole. Do not shut the door violently.

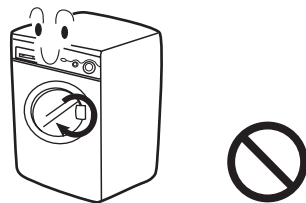

## Trouble shooting



The following circumstances do not constitute problems. Do not contact the maintenance service until the problem has been confirmed.

problem	Possible Cause
The washing machine fails to operate	<ul style="list-style-type: none"> <li>• Poor connection to power supply</li> <li>• Power failure</li> <li>• Door is not closed properly</li> <li>• Machine has not been switched on</li> </ul>
The washing machine does not fill with water	<ul style="list-style-type: none"> <li>• Water is not turned on</li> <li>• Water pressure is less than 0.05MPa</li> <li>• The inlet hose has a kink</li> <li>• Water supply failure</li> <li>• The door is not closed properly</li> </ul>
The water supply and drainage do not stop	<ul style="list-style-type: none"> <li>• Check that the height of the water hose is within 80-100cm</li> <li>• Check that the drain hose is not syphoning</li> </ul>
Drainage failure	<ul style="list-style-type: none"> <li>• Drainage hose is blocked</li> <li>• Drainage hose end is more than 100cm above the floor level</li> </ul>
Strong vibration during spin drying	<ul style="list-style-type: none"> <li>• Check that all packing bolts have been removed</li> <li>• The washing machine is located on an uneven surface of is not level</li> <li>• Check that all foam packing has been removed from the motor</li> </ul>
Operation stops before completion of the wash cycle	<ul style="list-style-type: none"> <li>• Water of electricity failure</li> </ul>
Excessive foam in the drum	<ul style="list-style-type: none"> <li>• The detergent is not a low foam type</li> <li>• Excessive detergent has been used</li> </ul>
Failure of the drying process	<ul style="list-style-type: none"> <li>• Poor connection to the power source</li> <li>• Door is not closed properly</li> <li>• Program has not been correctly set</li> </ul>
Incomplete drying	<ul style="list-style-type: none"> <li>• Check to see if the end of the water drainage hose is submerged in water</li> <li>• The filter is blocked</li> <li>• The machine is overloaded</li> <li>• The water tap is not tured on</li> </ul>

## Warning code

Warning code	Abnorma item	Content of identification	Action to take	Checking position and ask for help
E11	Water supply	The water level can not reach the reset water level within 5 minutes	Warning and stop running	Check if the water pressure is low or stops supplying
		The water level can not reach the setting water level within 8 minutes	Warning and stop running	Check if the water pressure is low or stops supplying
E12	Drainage	The water level can not reach the reset level in 8 minutes after drainage starting	Warning and stop running	Check if the water outlet of the drainage and adjust it and restart the machine
E13	Water supply	The water is above the warning level	Warning and stop running	Ask the technician to repair
E31	Motor	The feedback signal does not change in 8 minutes during the motor runs	Warning and stop running	Ask the technician to repair
EA3	Water level is abnormal in the drying process	The water is above the setting water level during the drying process	Warning and stop running	Check if the water outlet of the drainage and adjust it and restart the machine
EC1	Heater	The water temperature unchanged in 10 minutes	No heating and washing with cold water	Ask the technician to repair
EC2	Water temperature sensor	The drying sensor circuit short cut or open	Warning and stop running	Ask the technician to repair
EC3	Water level sensor	The water level sensor circuit short cut or open	Warning and stop running	Ask the technician to repair
EC4	The temperature of air vent	Within 30 minutes of dry phase there is 5 minutes in which the temperature is not increasing	Warning and stop running	Ask the technician to repair
EC5	The dry temperature sensor	The heater sensor circuit short cut or open	Warning and stop running	Ask the technician to repair
U01	Unlock the door	Can not unlock after 4 times try	Warning and stop running	Ask the technician to repair
U02	Lock the door	Can not lock the door after 4 times try	Warning and stop running	Ask the technician to repair
U03	Spin lopsidedly	The judgement of unbalance is above 1000g	Spin low speed and cancel drying	Disperse the clothings evenly in the tube
U04	Unclose the door	The door is unclosed	Warning	Close the door
E22	The memory function is failure	EEPROM goes wrong	Warning	Ask the technician to repair

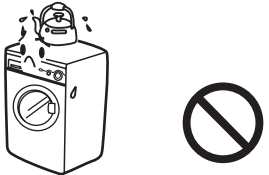
## Matters needing attention

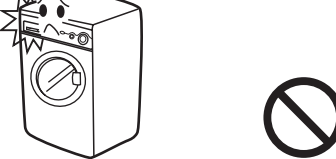
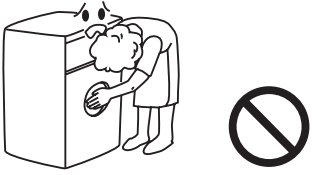
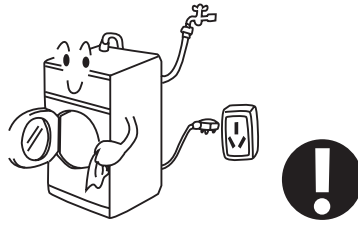
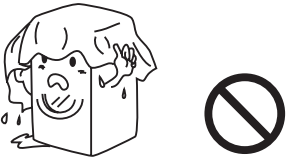
<p>3. Never place heavy objects, e.g. a heating appliance or water container, on the top panel of the washing machine.</p> 	<p>4. Do not wash foam rubber or simalar sponge materials.</p> 
<p>5. Before washing, close zippers, buttons, laces and repair damaged areas. Underwear and small items should be palced in a laundry bag or pillow slip. Do not wash clothes containing wire frames.</p> 	<p>6. Do not open the detergent dispenser during the wash cycle. Otherwise, the water will spill out from it and the detergent can not be washed out completely.</p> 
<p>7. The door is fitted with a self-locking device and can be opened when it is under the safety state ( water should be under the safe level; temperature inside the drum should be less than 55°C; the drum should do not run). Do not open the door except above condition otherwise the self-locking device will be damaged and the operator will get hurt.</p> 	<p>8. After washing, turn off the tap to prevent leaking; unplug the washing machine and wipe clean the lower part of the porthole.</p> 
<p>9. Keep the door slightly open when the washing machine is not being used. Never cover the machine a plastic sheet.</p> 	<p>10. The tumble dryer should not be used if industrial chemicals have been used for cleaning</p> <p>11. The appliance must not be installed behind a lockable door, a sliding door or a door with a hinge on the opposite to that of the tumble dryer.</p>

## Installation

- As shown in Fig.1, remove all the packing materials ( including the foam base ). It is normal that there are some water drops on the plastic bag, the cushion and the porthole. It is because of the water testing before leaving the factory.

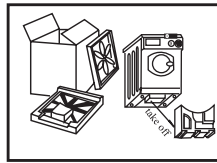

Fig.1

- Check attachments and materials

Name	Operational manual	Quality certificate	Water hose	Drain holder	Plastic plugs
Quantity	1	1	1	1	3

- Remove the packing screws as shown in Fig.2.

The packing bolts protect the appliance from impact damage during transportation. Follow the steps below before using the appliance.

- Remove the rear panel of the washing machine;
- Remove the three packing bolts from the rear panel of the washing machine, the rubber hose and then the shock absorption steel channel;
- Refit the back plate;
- Fill the holes left by the packing bolts with plastic plugs.

( Attention: the packing bolts and rubber hose should be kept in a safe place for later use )

There is a plastic jacket packing the door catch, please remove it when you unpack the machine. Do not let children touch it to void dangerous things.

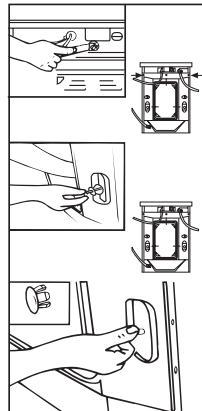

Fig.2

- Adjusting the position of the washing machine.

The washing machine is provide with adjustable feet. Before use, adjust the feet until the appliance is level, as shown in Fig.3.

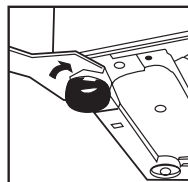

Fig.3

## Maintenance

- Remove the power plug, open the porthole and turn off the tap after washing to avoid to produce damp and strange smell in the drum. If the washing machine is not going to be used for a long period of time, put the drainage hose as lower as possible to let the water in the pipe out for avoiding the water turns bad quality and then put the pipe to the original place.

- The dissolved agent and anti-septics should not be used to clean the surface of the machine and rube apares. Only the clothing soaked with some soap liquid is suggested. Warning: Remove the power socket before the cleaning.



- Clean the detergent cartridge regularly: Pull the detergent cartridge up and out then wash it out. Put it back when it is clean.



- To prevent blockages to the water supply or the ingress of contaminants, clean the water inlet and inlet water filter regularly.



- Clean the filter ( once a month ) Press the lower edge of the filter compartment cover to open; ( Fig.1-2 ) Remove the filter by turning counterclockwise; ( Fig.3 )

Flash clean with running water;

Filter replacement is the reverse of removal. Caution: Attention shall be paid to ensure that the filter is replaced correctly to avoid possible leakage.

Using a flat-nose screw driver prizes the slits of two ends of the button panel and move the panel out with your hands. ( Fig.4-5 )

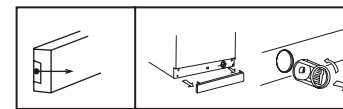

Fig.1

Fig.2

Fig.3

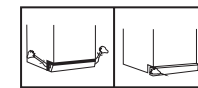
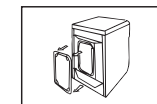

Fig.4

Fig.5

- If the machine is to be moved a distance location, replace the vibration mounting locks which were removed during installation as shown below.



Remove the back cover



Replace the rubber plugs

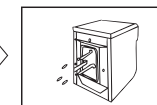

Insert the channel steel vibration locks insert the bolts



Tighten the bolts with a spanner



Replace the back cover

- Remove the power plug and turn off the tap and open the door if the machine is not going to be used for a long period of time. With the method there would not be any bad smell inside the tube.

## Additional information

### ● Tips

- Adding the soften agent can help the laundry to get rid of the static electricity and make the cloths feel softly and easy to iron.
- The following list shows the drying time for the different quantity and kinds of the laundry. You can select the expected drying program in accord with the quantity and the drying degree. The selected program will be over when the drying process is finished.

Weight of laundry ( Kg )	Time for drying	Remain time ( min )	Drying degree
0-1	Standard	59	Dried
1-2.5		120	Dried
0-1	60min	60	Dried
1-2.5			For ironing
0-2.5	30min	30	Dry and anti-bacterium program

## Installation

### Connection of water inlet hose and washing machine ( Using new hose-set and old hose-set should not be reused. )

- Place the water inlet hose nut on the connector of the water inlet valve.
- Slightly shake the water inlet hose nut to see if it is tightly and properly fixed.

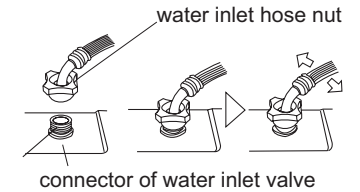

### Water drainage hose

- The height of the terminal of the water drainage hose should be between 80-100cm. The water drainage hose must be securely placed on the clip on the back of the washing machine.
- Use the water drainage support supplied as an accessory for proper installation of the water drainage hose. Fix the water drainage hose support with waterproof string. Do not use an excessively long water drainage hose and contract the authorized technician if the water drainage hose needs to be extended. The water drainage hose should not be extended more than 250cm ( longer extension will result in concurrent water inflow and outflow ). The diameter of the extension hose should be the same as the original hose.

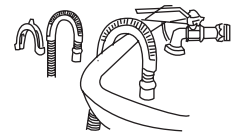
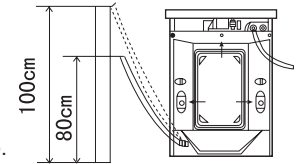

Caution: Water drainage hose must not be immersed in water.  
The original and extension hoses should be tightly connected.

### Connection of power supply

Check the following items before connection to the power supply.

- The socket conforms to the maximum power load ( The maximum current load of the socket and power supply cable should not be less than 15A ).
- Power supply voltage conforms to the required value.
- The power supply socket and the plug of the washing machine compatible, if they are compatible, refer to a washing machine technician or a designated service point for power cable replacement. The washing machine should be connected to the earth before use.

## Control panel

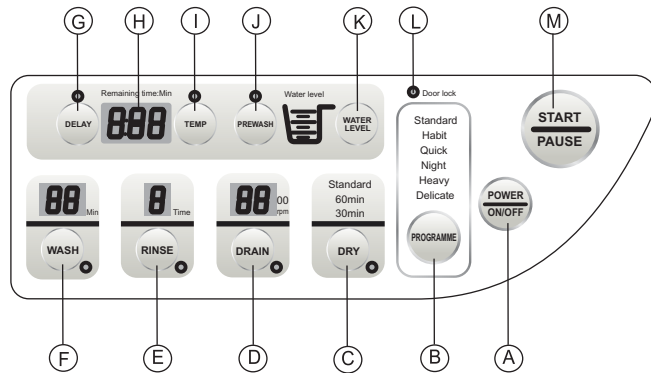

### A. POWER ON/OFF

Touch this button to switch on the power if the machine is not on power, and touch this button to switch off the power if the machine is on power.

### B. PROGRAMME

Touch this button then you can select the washing programs as you wish from top to bottom in proper order. The backlight is bright while the program is selected. The machine will carry out the standard program if there is no program to be selected. Attention: The machine has the memory function for the "Habit" program.

### C. DRY

The sequence of the dry program as follow as each time the button is touched after the washing program is set:  
 Whole auto dry program.  
 The standard program for the individual dry.  
 At this moment you can select either 60 min or 30 min program.  
 You can not select dry function while you have already selected the heavy or delicate program.  
 Attention: The maximal quantity of the laundry is 2.5Kg if the dry function is selected.

### D. DRAIN

The different spinning speed can be selected by touching this button. For details please see the program setting guide.  
 The spinning speed is 1000rpm ( 800rpm for night washing ) if the dry function is selected.

### E. RINSE

Touch this button to select the rinsing time. The time is changeable each time when it is touched and 6 times are the maxim.

### F. WASH

Touch this button to select the washing time. Increasing the washing period each time this button is pressed. The increasing step is one minute for one press.

## Installation

### ● Laundry loading

Evenly load the laundry in the washing machine and then tightly close the door of the washing machine.

#### Notice:

- 1) When first using the washing machine, let it run unloaded for one program to prevent the laundry from being tainted by oil or dirty water from the washing machine.
- 2) Do not overload the washing machine.

#### Reference loading

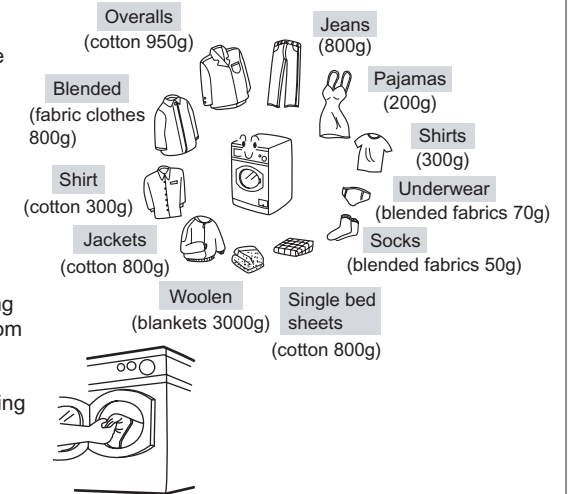

### ● Put detergent in the cartridge

There are three partitions in the detergent cartridge:  
 Partition 1 : It is used for the prewash function.  
 Partition 2 : Put the detergent in this partition no matter whether the prewash function is selected or not.  
 Partition 3 : Put the softening agent in this partition if the laundry has gone through the soften process.

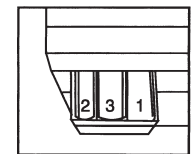

- Caution:
- 1) Do not add liquid degergent into partition 1 and partition 2
  - 2) For prewashing program, detergent should be added to both partition 1 and 2; for other programs, do not add detergent to partition 1
  - 3) Do not overuse softening agent as this may damage artificial fabrics

### ● Washing program setting

Set the washing program correctly in accordance with the laundry load.  
 First connect the mains and depress the power on/off button, the machine will work on the defaulted standard program. Depress the program selection button for the required washing program.

Notice: The above operation should be under the condition of no power down. The machine will continue its previous program if the machine has the memory function after the power down. The memory function can be canceled by turning off the power and restart it.



## Preparations

### ● Power supply

Plug in the power supply 220V/50Hz



### ● Water supply

Turn on the tap ensure that the water is clear.

Caution: Before starting the washing machine turn on the water faucet to ensure that the water faucet and the water inlet hose are connected correctly and do not leak.



### ● Detergent selection

The washing result depends on the quality of the detergent except the function performances of the washing machine. There are many brands of detergent in the market. For the best washing result, we suggest you using the special on-form detergent that produced for the auto drum washing machines.

For washing the wool and the chemical fibre please use the special detergent for those materials. Do not use dry-clean dissolvent.

Attention: Only put the quantity of the detergent in the cartridge for one time.

### ● Laundry treatment

- Sort out clothes according to type and extent of dirt. There are three types of clothes: cotton, synthetical and woolen ( silk ) fabrics.

- Separate white clothes from colored. If whites and coloreds are combined for one load, make sure the coloreds are colorfast.

- Remove all objects from pockets that may cause damage to the machine, such as keys and coins.



- Clothing with frayed edges or yarns should be put in a wash bag or special bag before washing.

- Repair damaged clothing, lose buttons or damaged zips and hooks before washing.

- Bed sheet and table ware should be loosely loaded and not folded.

- This washing machine is for household use and designed for mechanically washable clothes. When washing, separate unwashable clothes with reference to clothes labels.

### ● Wash load

Type	Non-fade cottons	Delicat fabrics	Woolen fabrics	Blending fabrics
Max load	5kg	2kg	1kg	2.5kg

## Operational functions

### G. DELAY

Setting the finished time of the scheduled washing by touching this button. The defaulted time for the scheduled washing is 9 hour. The washing time can be increased one hour by one touching of the button. If the button is pressed and held the time can be varied from 1 to 24 hour cyclically till the button is released. If the START/PAUSE button is pressed the current setting is confirmed after the scheduled washing program is ready.

If the time for the washing program is longer than the time of the scheduled washing then the program will work immediately after the START button is pressed.

Attention: There are some different between the setting time and actual time because of the water temperature, water pressure and the distributions of the laundry in the tube. There is no scheduled washing function for "Delicate" program.

### H. Remaining time: Min ( Digital display screen )

This display unit is used for warning the washing time left and fault information. It can display the setting time of scheduled washing and heating temperature. The screen only display the hour if the time setting is over 10 hour.

### I. TEMP ( Children lock )

Touch this button to set washing temperature. The temperature is changed cyclically each time the button is pressed. For the highest temperature setting of each program, please see the program setting guide. The "Delicate" program there is no temperature setting function. To lock button on the control panel by pressing this button for 3 second, which including the POWER button. These can be unlocked if this button is pressed for another 3 second.

### J. PREWASH

The prewash function can be added into the washing program.

### K. WATER LEVEL

The related time and water level in the drum can be selected by pressing this button in accord to the laundry quantity. The more bright the indicate light the more high the water level in the drum and the default washing time is longer with this height. The quantity indicator changes its position accordingly each time the laundry quantity button is pressed. We suggest using the first gear when the quantity is less than 1 Kg. And using the second gear when the quantity is less than 2.5 Kg. And using the last gear when the quantity more than 2.5 Kg. All other program setting indicate the default values when the laundry quantity is set. For each setting range please see the program setting for reference. The default program will be carried out if the function is not selected.

### L. Door lock indicator

This lamp is light when the door is locked and the machine is in the operation state and the door can not be opened. If the condition for opening the door is met, press the START /PAUSE button this lamp is off and the door is unlocked and the door can be opened.

### M. START/PAUSE

The set program is carried out while this button is pressed. To pause the current program, just press this button and the program will not operate at the moment. Pressing this button again if you want to resume the operation. The program can not be reset in the process of running or pause state. Turning off the power and turning on it again if you want to reset programs.

## Program selection

Program name	Option	Suitable condition	Quantity	Program and washing time			
				Wash ( min )		Rinse ( time )	
				Default	Range	Default	Range
Prewash	/	for dirty cloth	below 5 kg	add 12 minutes washing	/	/	/
Standard	wash/rinse /spin	ordinary cloths washing	below 5 kg	25	5-60	3	0-6
	wash/rinse /spin/dry		below 2.5 kg	21	5-60	2	0-6
	wash/rinse /spin/dry		below 1 kg	17	5-60	2	0-6
Habit	wash/rinse /spin	self defined washing program according to the habit of the operator	below 5 kg	25	5-60	3	0-6
	wash/rinse /spin/dry		below 2.5 kg	21	5-60	2	0-6
	wash/rinse /spin/dry		below 1 kg	17	5-60	2	0-6
Quick	wash/rinse /spin	for not very dirty cloths	below 5 kg	8	5-60	2	0-6
	wash/rinse /spin/dry		below 2.5 kg	6	5-60	2	0-6
	wash/rinse /spin/dry		below 1 kg	5	5-60	2	0-6
Night	wash/rinse /spin	for night washing	below 5 kg	25	5-53	3	0-6
	wash/rinse /spin/dry		below 2.5 kg	20	5-53	3	0-6
	wash/rinse /spin/dry		below 1 kg	15	5-53	3	0-6
Heavy	wash/rinse /spin	for thick or heavy cloths	below 5 kg	40	5-60	3	0-6
Delicate	wash/rinse /spin	cashmere and wool fabrics	below 2 kg	6	1-15	2	0-6
Standard	dry	dry the ordinary laundries	below 2.5 kg	120	/	/	/
60min	dry	dry the ordinary laundries	below 2.5 kg	60	/	/	/
30min	dry	anti-virus process for dried laundry	below 2.5 kg	30	/	/	/

Attention: The above list is just for your reference since the temperature, water pressure and function you selected may verify for different laundry.

## Program selection

Program and washing time						The methods for using detergent		
Drain ( rpm )		Temp ( ° C )		Total time consume ( min )		Partition1	Partition2	Partition3
Default	Range	Default	Range	Default	Range			
/	/	/	/	/	/	★	★	○
800	0/600/800/1000	cold	cold/30/40/60/90	59	7-185	☆	★	○
1000	0/600/800/1000	cold	cold/30/40/60/90	168	7-299	☆	★	○
1000	0/600/800/1000	cold	cold/30/40/60/90	103	7-235	☆	★	○
800	0/600/800/1000	cold	cold/30/40/60/90	59	7-185	☆	★	○
1000	0/600/800/1000	cold	cold/30/40/60/90	168	7-299	☆	★	○
1000	0/600/800/1000	cold	cold/30/40/60/90	103	7-235	☆	★	○
800	0/600/800/1000	cold	cold/30/40/60	32	7-168	☆	★	○
1000	0/600/800/1000	cold	cold/30/40/60	151	7-282	☆	★	○
1000	0/600/800/1000	cold	cold/30/40/60	89	7-218	☆	★	○
800	0/600/800	cold	cold/30/40/60	67	7-177	☆	★	○
800	0/600/800	cold	cold/30/40/60	184	7-292	☆	★	○
800	0/600/800	cold	cold/30/40/60	118	7-228	☆	★	○
600	0/600	cold	cold/30	62	7-164	☆	★	○
600	0/600	cold	cold	29	3-82	☆	★	○
/	/	/	/	120	120	☆	☆	☆
/	/	/	/	60	60	☆	☆	☆
/	/	/	/	30	30	☆	☆	☆

Notice: ○ indicates that softener or bleach can be added if needed  
 ☆ indicates that detergent must not be added  
 ★ indicates that detergent must be added

## Free Manuals Download Website

<http://myh66.com>

<http://usermanuals.us>

<http://www.somanuals.com>

<http://www.4manuals.cc>

<http://www.manual-lib.com>

<http://www.404manual.com>

<http://www.luxmanual.com>

<http://aubethermostatmanual.com>

Golf course search by state

<http://golfingnear.com>

Email search by domain

<http://emailbydomain.com>

Auto manuals search

<http://auto.somanuals.com>

TV manuals search

<http://tv.somanuals.com>