

**Fuzzy Computerized Automatic
Washing Machine**

User's manual



This manual is for
XQS60-78H

- Please read this manual carefully before using.
- Retain it for future reference.



0030804888A

CONTENTS

Names of the parts.....	1
Safety precautions	2
Installation and adjustment	4
Install the water inlet hose.....	6
Preparation before washing	8
Put in the laundries	9
Put in the detergent	9
Use the operation buttons	10
Close the top lid	14
Finish washing	14
Disposal after washing	15
Trouble shooting Answer to question.....	16
Packing list Specification.....	17

Description of heating function

1. Heating function can be selected for "STANDARD", "QUICK", "JEAN" and "POSTHASTE" programs, but it's unavailable for "RINSE" process.



2. If heating function is selected, for water levels "1" or "2", it begins to heat after water reaches the set level, and begins to wash when the set temperature is reached; for water levels "3"- "6", it begins to heat upon water reaching level "2", it continues water supply and gently agitates while heating to the set temperature, then it begins STANDARD washing; for water levels above "6", the cycle is: after water reaching level "2", it begins to heat, meanwhile water supply continues until level "6", water supply stops and it continues heating to the set temperature, then it begins to wash while water supply is resuming, (the hot water temperature then is good for detergent active enzyme function and for the clothes to be in an optimum detergent concentration with a good washing effect. The subsequent washing while water supply can facilitate dirt flushing and removing), water supply stops when reaching the set level, then it continues to wash STANDARDly. (For high water levels, only the water amount below level "6" can be heated to the set temperature, then it washes and supplements water to the set level)

3. This washing machine provides 3 temperature selections of 20°C, 30°C and 40°C.

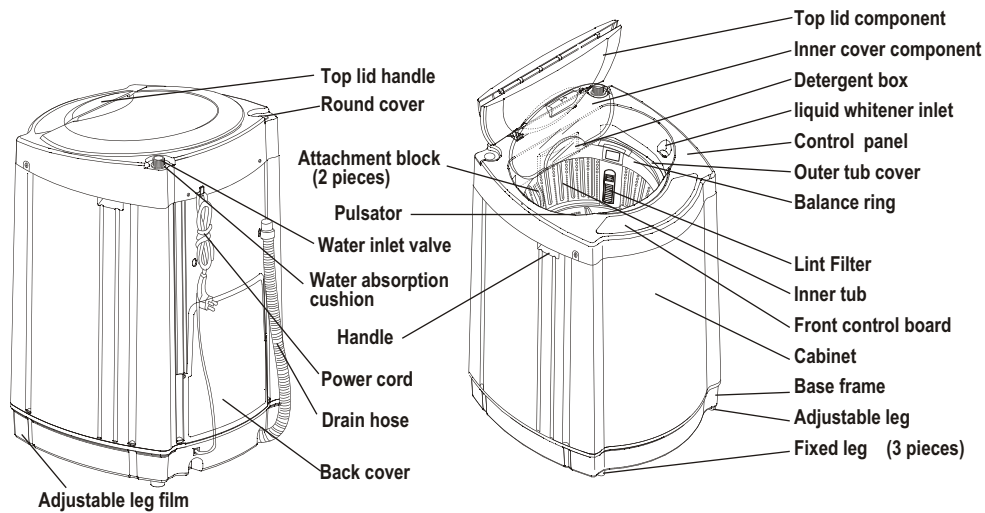
Names of the parts



Meaning and description of the symbols

<p>Warning sign</p> 	<p>Contents marked with that symbol are related to the safety of the product and the personal safety of the users. Please operate in strict conformity to the contents, otherwise it may cause damage of the machine or injure the personal safety of the user.</p>
<p>Forbidden sign</p> 	<p>Contents marked with that symbol are actions forbidden to perform. Performing of those actions may result in damage of the machine or injure the personal safety of the user.</p>

Safety precautions

Please plug the plug on special 220V AC receptacle. Be sure to use single-phase three pins receptacle. Ensure the earthing prong of the power receptacle is earthed reliably. Use leakage protector if possible.



In normal usage of the washing machine, the power plug shall be ready to be pulled or plugged with hang. Be sure to pull the plug off and close the water faucet when occurring power failure, delivering the maching, setting the machine idle or cleaning the machine, do not plug or pull the power plug with wet hand.



Do not bend, stretch, twist, bind the power cord by force, or reform it. Do not press or clamp it with heavy items. If the power cord and power plug are bad, or the receptacle is loose, be sure to have it replaced by the technicians of our special shop or our agent, or the after-sales service department to avoid any risk. Keep the prong of the power plug clean. If dust is found on the power plug, please wipe it off with dry cloth.



In case the washing machine is installed on ground with carpet, be careful not to block the ventilation hole with carpet.

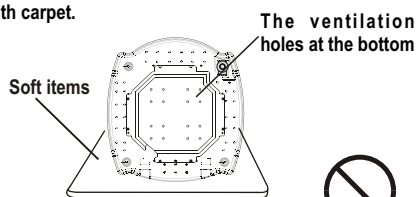

Do not use water with temperature higher than 50°C



Do not put the machine at damp place like the bathroom. Never wash it with water. Do not put wet laundries on the front control panel board..

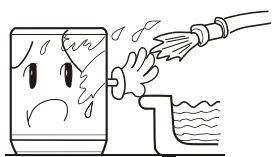

Do not wash water-proof laundry like the raincoat, bike-covers, down textiles etc. To avoid abnormal vibrations in spinning and damages to the laundries-



Do not let the machine share one receptacle with other electric appliances. If the power plug is damaged, or the plugging into the receptacle is loose, do not use the plug any more.

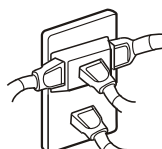

Safety precautions

• Do not put hand into the rotating tub. It is dangerous even if the rotation speed is slow. Take special care of the children. Keep children away from the washing machine to avoid them climbing on.



• Do not decompose, repair or alter the machine by yourself.



• Do not put any hot or heavy items (such as the kettle with hot water) on the washing machine.



• Do not wash laundry with volatile materials (such as thinner, petrol etc.).

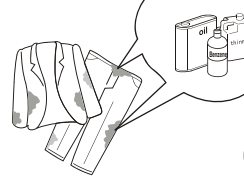

• The handicapped or children without care shall not use the machine.

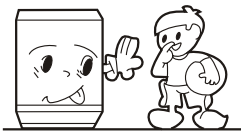

• Keep the machine away from direct sunlight and heat source like the heater.

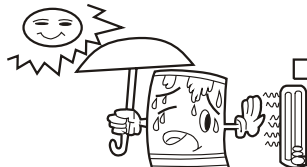

• Please keep the lint filter in good condition, and install it to proper position during washing. If the lint filter is lost or damaged, please contact the local after-sales service department of our company.

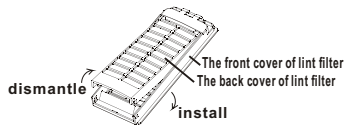

• To protect your laundries and washing machine, please take out all of the coins, buttons, sand, hairpin and other foreign materials before washing.

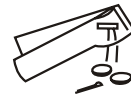

• Please check if the water faucet is open, and if the connection of the water inlet pipe is proper.
• It is suggested to use foamless washing powder.

Installation and adjustment

Please install and adjust the machine according to the requirement of the manual. It is very important to your security and correct operating the machine.

Install the inner cover component

1. Open the top lid of the washing machine.
2. Put the inner cover component on the outer tub cover, aiming the inner cover shaft to the installation hole of the corresponding outer tub cover shaft groove.
3. Firstly insert the inner cover shaft of one side into the corresponding outer tub cover shaft groove, then push the another inner cover shaft into the corresponding outer tub cover shaft groove. Please install to designated position to guarantee there are no dropping or abnormal sound in opening and closing of the inner cover, and the operation shall be smooth. Do not dismount the inner cover component after washing.

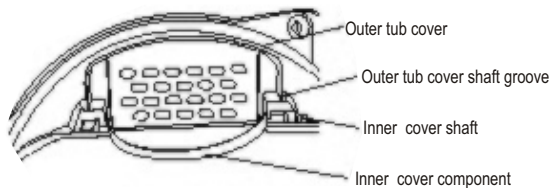

Figure 1

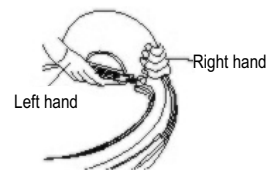
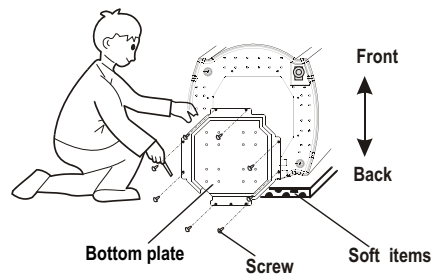

Figure 2

Install the bottom plate

After opening the package, please lean the washing machine gently down on soft items (like towel cloth, blanket, etc.). Install the bottom plate to the bottom of the machine with eight screws by a cross screw driver, then lift the machine up gently. See to the figure:



Adjust the Installation position

The largest allowable slope of the shank base of the machine is 1° . The slanting or rough ground will result in unstable running or stoppage of the machine. Please adjust it with following methods:

- Confirm it's horizontal:
Hang the lead line to check if it is horizontal.

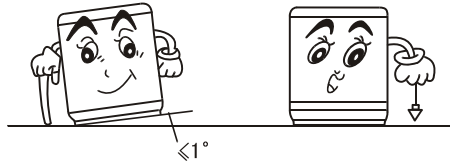

- Adjust the adjustable leg:
 1. To twist the adjustable leg, please first lift up the side of the leg slightly, loosen the adjustable nut, and twist the leg.
 2. After adjustment, fasten the nut.

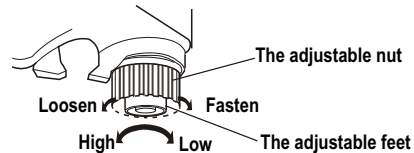

Usage the drain hose

The drainage shall be smooth with the drain hose.

1. The height of the drain hose shall be less than 10cm, or the drainage will not be smooth, and cost such long time that the machine may stop at mid way.

2. Do not step on or press the drain hose.

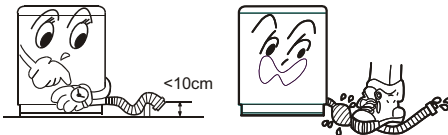

3. If the drain hose is too long, cut it at mid point. To make smooth drainage, cut the front end of the hose slantingly.



4. If extra drain hose is needed, please make separate purchase. The inner diameter of the extra hose shall not less than 30mm, and the length shall not exceed 1.5m.

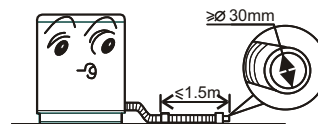

5. If the extra hose is too long, cut it either at A or at B point.

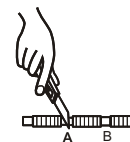

Install the water inlet hose

Confirm the water faucet

water faucet, suitable



The exit end face of the faucet

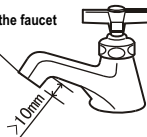

water faucet, not suitable

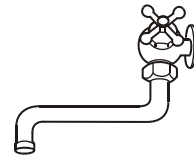

It is required that the front end shall be longer than 10mm.

The exit end face of the faucet shall be flat and smooth. If not please file it to avoid leakage.

Connection between the water inlet hose jointer and the water faucet

1. Press the lower end of the lock lever and push down the slider. Take off the water inlet hose jointer from the water inlet hose component. See to Figure 1.
2. Loosen the screw till the water faucet can be accessed. Put the jointer of the water inlet hose on the faucet. See to Figure 2. (If the faucet is too large and the jointer can not be set on the water faucet, please loosen the four screws and take out the bushing in the jointer. The front end of the faucet must be smooth, otherwise it may leak water. See to Figure 3.)

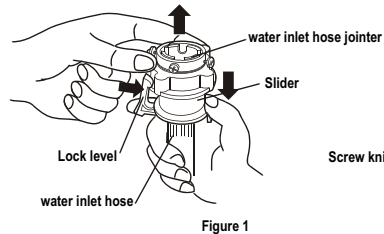

Figure 1

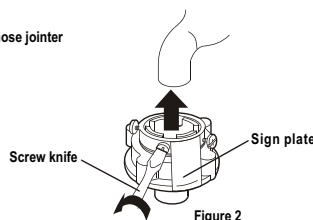

Figure 2

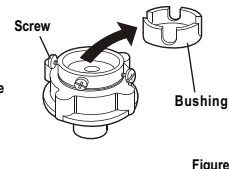

Figure 3

3. Fasten the four screws evenly. See to Figure 4.

4. Take off the nameplate. Twist the fastening nut as per the indication of the figure to seal up the exit end face of the faucet. See to Figure 5.

remark: Before installation, the threading is 4mm above the upper surface of the nut. After installation, the threading is 2mm above the upper surface of the nut..(see to figure 6)

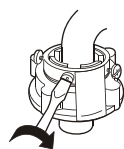

Figure 4

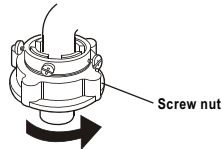

Figure 5

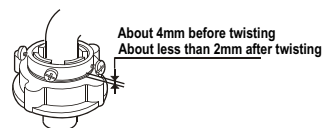

Figure 6

Connection between the water inlet hose and the washer

1. Do not take off the water absorption cushion. Please check if the cushion is dropped or damaged before each usage. If it happens please contact our after-sale department immediately.

2. Put the nut of the water inlet hose on the valve jointer.

3. Fasten the nut. Swing it gently to confirm if it's suitable.

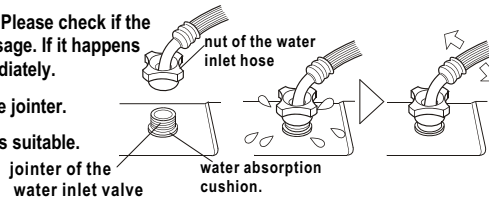

Connection between the jointer of the water inlet hose and the water inlet hose

1. Push down the slider. Insert the water inlet hose into the jointer.

2. Hang the lock lever to the jointer. Release the slider till a click sound is heard.

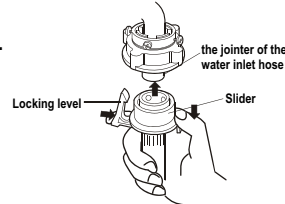

Check the connection between the jointer of the water inlet hose and the water faucet

1. Swing the hose gently to confirm if it is fastened stable.

2. After installation, open the faucet to check if it leaks.

3. Do not bend the hose with overstrain.

4. Before each usage please check if the connection between the jointer of the water inlet hose and the water faucet, and the installation of the water inlet hose are firm, so as to prevent dropping from improper installation position.

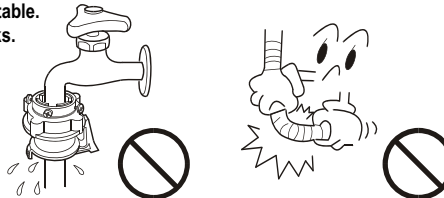

Dismantle the water inlet hose

1. Close the water faucet.

2. Press the locking lever. Push down the slider. Then pull of the water inlet hose.

If the machine is used frequently, the jointer of the water inlet hose can be kept on the faucet to prevent damaging the fixing screw.

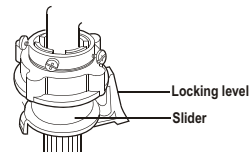

1 Preparation before washing



Preparation before washing

1. Connect the water inlet hose.
2. Confirm that the washing machine is earthed reliably. Then insert the power plug into the receptacle. Do not connect the earth terminal to the gas pipe and tap water pipe.
3. Put down the drain hose.

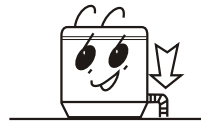

Pay attention to followings before washing the laundries

<p>Confirm if there's special requirement for the laundries.</p>	<p>Clear the pocket. Take out the coins, sand, hairpins etc.</p>	<p>Fasten the buttons and zippers.</p>	<p>The quantity of the laundries shall not exceed the rated value. The big laundries like the jeans shall be put in loosely.</p>	<p>When the pulsator is running, the buttons of the laundries may cause noise. For the sake of discretion, please put the laundries with buttons into other laundries.</p>
<p>a. Check if the laundries are applicable for washing with machine. b. Divide the laundries with infest color from other laundries. c. Put those laundries difficult to absorb water into water with hand. d. For those laundries with heavy soil, please first remove the dirt like mud or dust. For the parts with heavy soil, please apply detergent in advance, which can make it easier to remove the soil. e. For those laundries that may get lint ball and those with long fur, turn it over before putting in. f. Do not put those laundries polluted by chemicals directly into the washing machine.</p>				

2 Put in the laundries



- The capacity of washing of the machine refer to the largest weight of the standard laundries under dry condition that can be washed in one time. Laundries quantity in one washing cycle shall be lower than the rated capacity. The largest capacity of this machine is 6.0 kg.
- The thickness ,size , type of the cloth will influence the actual washing capacity. It is suitable to put in reasonable amount of laundries and the laundries can be turned round in washing for one time washing.
- Do not select the higher than "4" water level for laundries less than 1.0kg ,so as to avoid splashing of water.

3 Put in the detergent

Access for detergent and washing powder

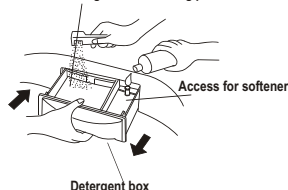

- Put the washing powder and softener into the detergent box directly as indicated in the left figure.
- After that, please close the detergent box. Refer to the following list for the usage of the detergent :the standard dosage of the detergent and the water quantity.

How to use the whitener

- Fill water to decided level .Dilute the whitener with container. Pour it slowly into the washing tub.
- Avoid using whitener on laundries with colour or pattern as they are prone to lose colour.
- The whitener shall not touch the laundries directly.
- Refer to the user's manual for the usage and quantity of the whitener.
- For powder whitener, please dissolve it before use.

How to use softener

- See to the manual of softener for the usage and dosage. When adding softener into the softener inlet of washing powder box, note that it shall not exceed the lower side of the cap.
- Do not leave the softener for long period after adding it into the box. Otherwise it may be solidified and block the inlet.
- As the softener is easy to solidify, please clean the box frequently. (You shall clean it each time you use reserve function).
- Before use softener, you must select to sterilize function.

How to use the washing powder

- Directly dissolved in the machine (not applicable for fuzzy program and reserve wash)
 - 1.Fill small quantity of water.
 - 2.Add the powder Run for 30 seconds to dissolve it completely.
 - 3.Put in the laundry. Select suitable water level.
- The instant dissolving of the washing powder:
 - 1.Prepare warm water of 30 °C and a container.
 - 2.Add the powder while stirring to fully dissolve it In selecting
- The super quick program, it is suggested to adopt liquid detergent instead of washing powder to guarantee the washing effect.
- The powder is more prone to pollute the laundry than the detergent. Therefore please use it with suitable quantity.
- It is suggested not to use high sudsing detergent.
- Washing powder with poor quality or long time storage maybe caked. Please pay attention to cleaning the detergent box in time.

4 Use the operation buttons

a Description of the function of buttons

Mode and meaning of the indicators

- ○ : Flashing: indicate the running program
- On: indicate the program about to run, or indicate the selected mode

Digital tube

- During sensing, it displays --
- During operation of programs, it displays the remained time (minute) or remained times of the corresponding procedure

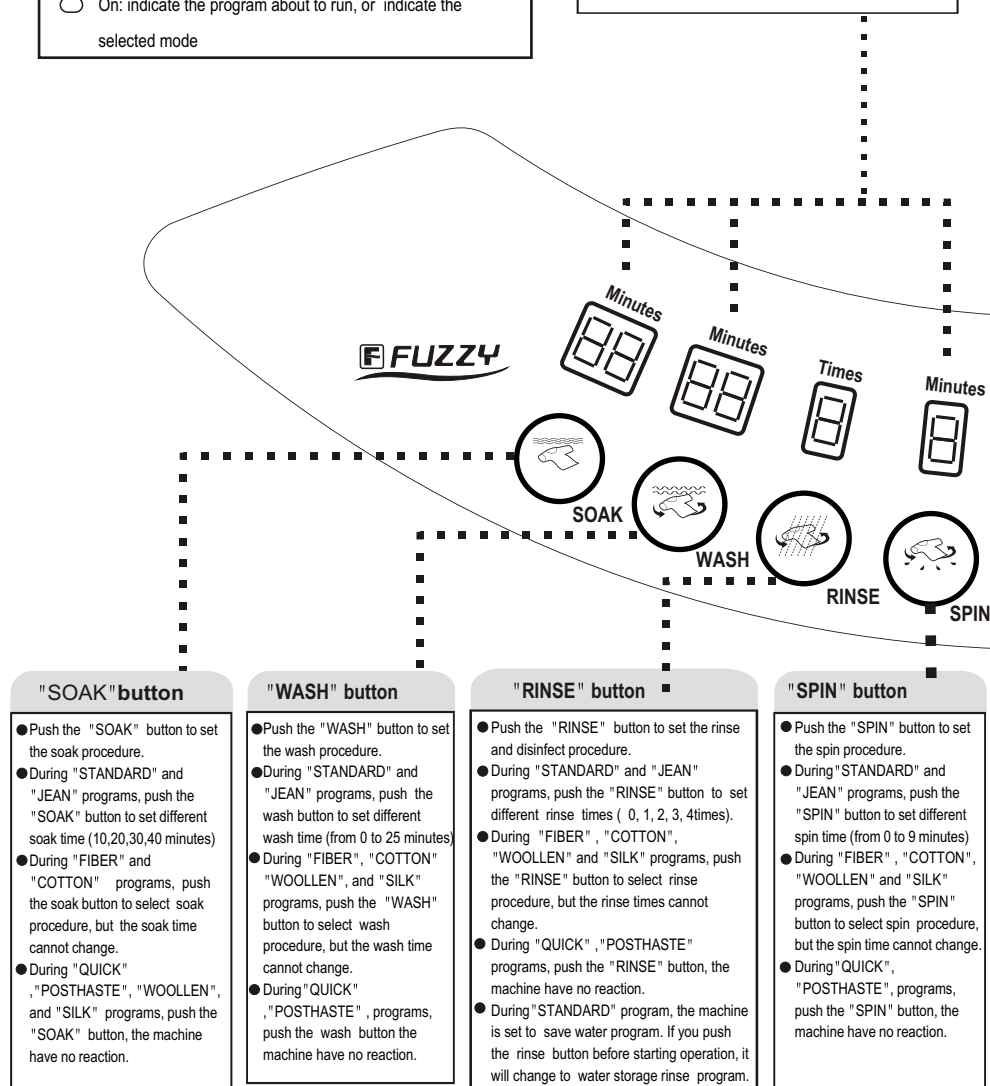

CHILD LOCK FUNCTION

- Push and hold the WATER LEVEL button and SPIN button, then push down the POWER ON/OFF button. The digitron displays CL. You can continue setting desired washing procedures. After setting, push down the START/PAUSE button. The child lock function is activated. All of the buttons are locked and cannot make selection.
- Release the child lock function: push down the WATER LEVEL and SPIN button at the same time for more than 1 second. After a beep sound, the child lock function is released.

"POWER ON/OFF" button

- Push the ON/OFF button to switch on the power.
- When the power is on, push it again to switch off the power.
- Push the ON/OFF button to switch on the power. If the START/PAUSE button is not pushed, the washing machine will automatically switch off the power after 5 minutes.

"RESERVE/REMAIN" time indicator digitron

- During sensing, it displays --
- During reserve procedure, it displays the remained reserve time (in hours)
- During operation of programs, it displays the remained time (minutes). If the remained time exceeds 99 minutes, it adopts A at tens place to represent 100 minutes, b to represent 110 minutes. For instance, A3 represents 103 minutes.
- In case of abnormal phenomenon, it displays the abnormal symbol (see to Page 16)

Page 16

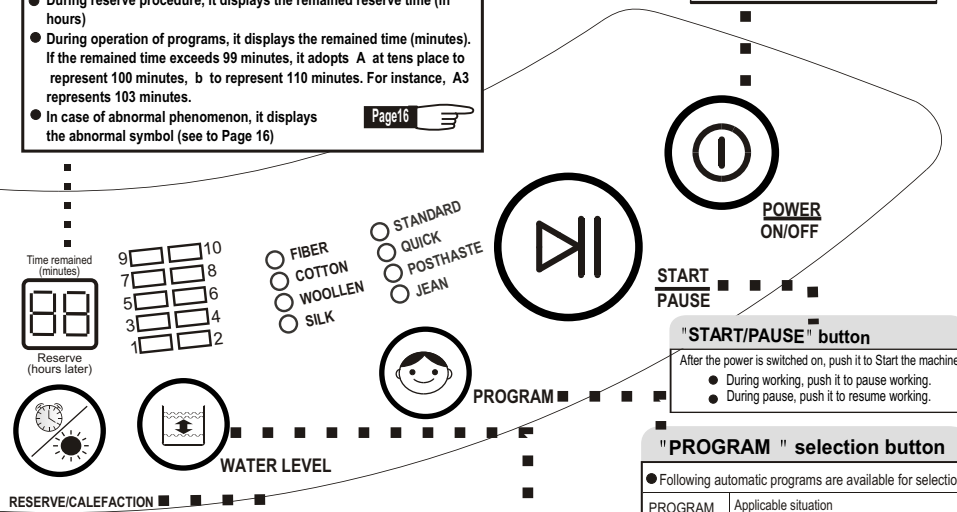

"START/PAUSE" button

- After the power is switched on, push it to Start the machine
- During working, push it to pause working.
- During pause, push it to resume working.

"PROGRAM" selection button

- Following automatic programs are available for selection

PROGRAM	Applicable situation
STANDARD	Common washing
QUICK	Quick and high-efficiency wash for common
POSTHASTE	Super quick wash of the laundry under 1 kg with light soil
JEAN	Washing the relatively big and thick laundries
FIBER	Washing the chemical fiber laundries
COTTON	Washing the cotton textiles
WOOLLEN	Washing the woolen textiles
SILK	Washing the textile

"RESERVATION/CALEFACTION" button

- Press "RESERVATION/CALEFACTION" button to set reservation or heating Function.
- During machine running, the digitron indicates the cycle remaining time (in minutes). Press "RESERVATION/CALEFACTION" button, the digitron will indicate the remaining reserved time to cycle end (in hours). The digitron will indicate the running state of the machine.
- Heating function can be selected if keep pressing "RESERVATION/CALEFACTION" button for more than 2 s. If the decimal point of digitron is lighted, it means heating function is selected. The initial temperature is about 30°C, and you can select your desired value in a switching sequence 30°C → 40°C → off → 20°C. If keep pressing the "RESERVATION/CALEFACTION" button for more than 2 s again, the temperature indicator turns off, and the Reservation can be selected, you can select reserved time.
- After the machine starts running, if selection or cancellation of heating function is desired, you should switch off the power and reselect.

"WATER LEVEL" button

- The washing machine can detect the laundries automatically. After detection, it will set the water level to suitable value among 4, 6, 8, and 10 automatically.
- You can also set water level by yourself. After the machine is started, it will not set water level automatically. You shall push the start/pause button to make new setting.
- If there's water inside the tub, the machine cannot detect the laundries and will display water level 6.
- If wet laundries are put in, it may display water level 10. You must set suitable water level by yourself.
- If POSTHASTE programs selected, it will display water level 3.
- When water level 2 is reached in water filling, it will perform washing while filling water. When water level 3 is reached, it will change to normal washing.
- During operation of wash and rinse program, you can push down the water level button to add water. When you release the button, or it reaches the overflow water level, the machine will stop adding water.

b Steps of using the operation buttons and description of the steps

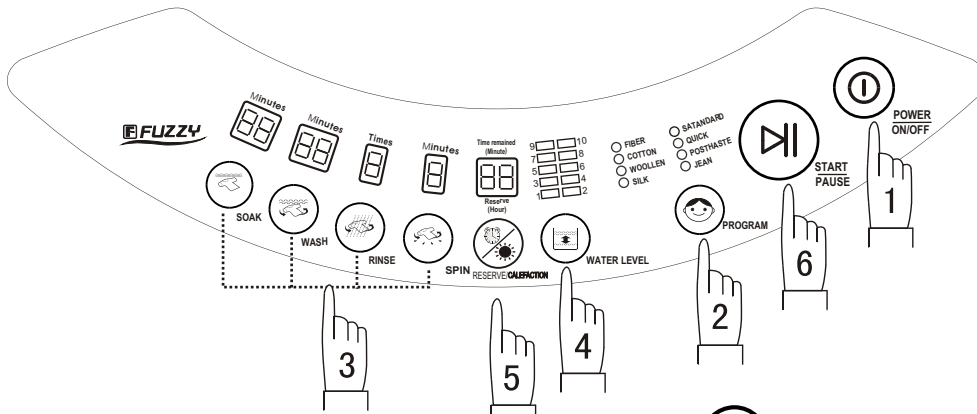

1 Push the "POWER ON/OFF " button to switch on the power.

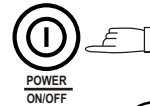

2 Push the "PROGRAM" button to select suitable automatic program.



After switching on the power, the machine will set "STANDARD " program automatically. To select other automatic program, push the "PROGRAM" button till the relative indicator is on. Refer to the "PROGRAM" button on Page 11 for the selection.

For instance: select "POSTHASTE" program for laundries with small quantity and light soil.

Page 11

● In selecting the "....." program, the machine will execute fuzzy program to select water and wash time according to the cloth and weight of the laundries. The full procedure is controlled automatically.

- | | |
|-----------|-------------|
| ● FIBER | ○ STANDARD |
| ● COTTON | ● QUICK |
| ● WOOLLEN | ● POSTHASTE |
| ● SILK | ● JEAN |

3 Push the "SOAK", "WASH", "RINSE" OR "SPIN" button to select suitable procedure.

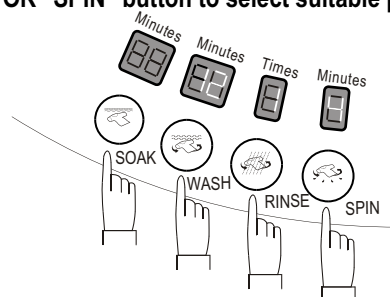

After switching on the power, the washing machine will set to common program including "wash, rinse, spin" automatically. To select other procedures, push the "SOAK", "WASH", "RINSE" or "SPIN" button to select the time of soak, wash and spin, and the times of rinse. After switching on the power, if you push one of the button among "WASH", "RINSE" and "SPIN", the digitron of the former procedures will turn off automatically. The former procedures will not run. For instance: after switching on the power. If you push the "SPIN" button first, it will execute spin singly after starting.

Attention

- Even there's no water in the tub, a certain period is required before spin starting.
- Do not use the soak program for the woolen textiles.
- Separate the laundries that are not colorfast from other laundries in washing.
- The pulsator will not rotate unless the water is filled to "3" water level.

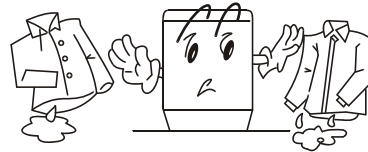

- The soak procedure can work in cooperation with automatic programs like standard, jeans, fiber and cotton. There is intermittent pulsator stirring during soak.
- After the machine starts operation, you can only set the program and procedure during washing, and can not make setting in other cases.

4 Press "WATER LEVEL" button, select suitable water level

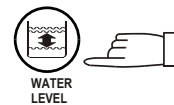

After switching on the power, the washing machine will execute fuzzy program automatically to detect the cloth. After detection, it can set the water level automatically. To select other water level, first push the "START/PAUSE" button, then push the "WATER LEVEL" button to set the water level. Refer to "water level button" in Page 11 for selection.



5 Push the "RESERVE/CALEFACTION" button to select suitable reserve wash program



RESERVE/CALEFACTION

After switching on, the washing machine reserved wash program will be automatically set inactive. If you desire a wash cycle to end at a reserved time, you can press the "RESERVATION/CALEFACTION" button to set a reserved wash program. Refer to The button of "RESERVATION/CALEFACTION" on page 11.

• Confirm the reserve program

Page 11



- When "RESERVATION" becomes active, the nixie tube displays the time to the end of the reserved wash cycle, and the indicator turns on.
- To change the running program or cancel the reservation, you should cut off the supply and reselect.



• Confirm the heating function

the washing will finish about 18 hours later

- Keep pressing the "RESERVATION/CALEFACTION" button for more than 2 s, the heating indicator turns on (red).
- Keep pressing the "RESERVATION/CALEFACTION" button for more than 2 s again, the heating indicator turns off and heating function is cancelled.
- After the machine starts running, if selection or cancellation of heating function is desired, you should switch off the power and reselect.

6. Push the "START/PAUSE" button



START
PAUSE

5 Close the top lid

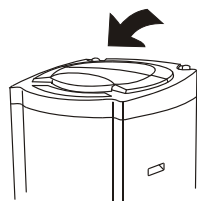

As the top lid opened, the Washer will automatically give an alarm and stop running, exclusively during supplying water and rinsing.

6 Finish washing



After finishing wash, it will alarm automatically.

7. Disposal after washing

- After using, please clean the lint and foreign materials of the lint filter etc. in time. Otherwise it may influence your using the machine.
- Please first pull off the power plug from the receptacle before cleaning.

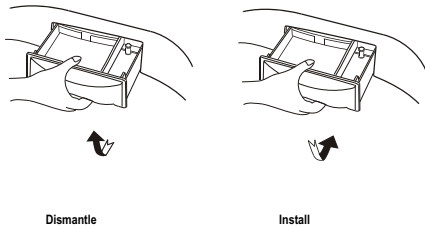
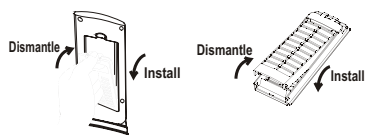
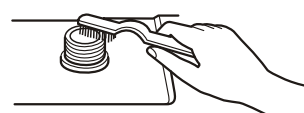
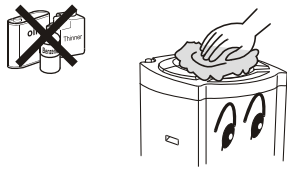
<p>Clean the detergent box and set it on the control panel seat.</p> <p>1.The method of dismantle : Push it up aslant and gently.</p> <p>2.The method of install : install it upwards and aslant and push it in .</p>  <p style="text-align: center;">Dismantle Install</p>	<ul style="list-style-type: none"> ● The lint filter must be used during washing. ● It must be cleaned in time after each using <p>Lint filter:</p> <p>1.Rotate the inner tub with hand till the lint filter reaches the position convenient for you to take it off. Pull it up to dismount.</p> <p>2.Push it down to install.</p> <p>3.Clean the filter screen after washing.</p>  <p style="text-align: center;">Dismantle Install Dismantle Install</p>
<p>The filter screen of the water inlet valve is likely to be blocked by foreign materials and influence the water inlet.</p> <p>Please clean it with brush every two months.</p> 	<p>If the cabinet is dirty, wipe it with wet cloth</p> <ul style="list-style-type: none"> ● Do not flush it directly with water. ● Wipe it with neutral detergent. ● Do not wipe it with thinner, petrol, alcohol etc. 

- 1.After washing, close the water faucet. (If needed, you can dismantle the water inlet hose).
- 2.Do not store water in the washing machine for a long period. Drain the water completely after each using.
- 3.Be sure to pull off the power plug before maintenance.
- 4.Hang up the power cord and drain hose.
- 5.Wipe off the water drops on the surface of the machine and inside the tub. Open the top lid for some time (about 1 hour), then close the top lid.

Trouble-shooting Answer to question





(If there's breakdown, please pull off the power plug before checking) The following phenomena are not breakdowns sometimes. Please confirm again before sending it to repair. If there are real breakdowns, please come to the special maintenance department or after-sale service department of our company. Do not repair it by yourself.

Phenomenan		The reason	How to settle
The digitron displays E0.		<ul style="list-style-type: none"> The top lid is opened during reserve procedure. 	<ul style="list-style-type: none"> Close the top lid.
The drainage cannot work, or is too slow. The digitron displays E1.		<ul style="list-style-type: none"> Is the drain hose put down? Is the drain hose blocked? 	<ul style="list-style-type: none"> Put down the drain hose. Open and close the top lid once. Clean the foreign material. Open and close the top Lid Once.
It stops running in midway. The digitron displays E2.		The top lid is not closed.	Close the top lid.
The safety switch acts, and the spinning cannot work. The digitron displays E3.		<ul style="list-style-type: none"> Are the laundries put slantingly? Is the machine slanting? 	<ul style="list-style-type: none"> Reorder the laundries. Close the top lid. The machine will start running after 10 seconds of being placed horizontally.
The water filling does not work, or is slow. After about 40 minutes later, the digital displays E4.		<ul style="list-style-type: none"> Is the water tap opened, or is there water supply failure? Is the water inlet valve blocked? Is the water pressure too low? 	<ul style="list-style-type: none"> Open the water tap. Push the Start/Pause button once. Clean the water inlet valve then push the Start/Pause button once. Push the Start/Pause button once.
The digitron displays E5.		<ul style="list-style-type: none"> The temperature sensor is fallen. 	<ul style="list-style-type: none"> Please contact the after-sales service department.
The digitron displays E6.		<ul style="list-style-type: none"> The water level sensor is bad. 	<ul style="list-style-type: none"> Please contact the after-sales service department.
The digitron displays F5.		<ul style="list-style-type: none"> The water level drops to the replacement point after it has supplied water for 2 times during the whole process. 	<ul style="list-style-type: none"> Open and close the top lid once.
The machine does not act	Not wash	<ul style="list-style-type: none"> Is there power failure? Is the power plug inserted tightly? Is the water level reached preset position? 	<ul style="list-style-type: none"> Please use it when there's power supply. Insert the power plug tightly. Fill water to the preset position.
	Not spin	<ul style="list-style-type: none"> Is the power plug inserted tightly? Is the top lid closed reliably? Are the laundries set flat? 	<ul style="list-style-type: none"> Insert the power plug tightly. Close the top lid. Set the laundries flat.
There's abnormal sound inside the machine		<ul style="list-style-type: none"> Is the machine slanting? Are the laundries put slantingly in spinning? Are there any foreign materials? 	<ul style="list-style-type: none"> Adjust the machine to be even Reorder the laundries and close the top lid. Remove the foreign materials.
The water tap leaks		<ul style="list-style-type: none"> Is the screw of the jointer of water inlet hose loose or awry? 	<ul style="list-style-type: none"> Fasten the screw of the jointer properly.

Common phenomena

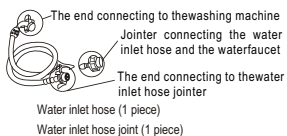
Phenomena	Explanation
* The spinning is intermittent when it starts.	* Balance the laundries to avoid slanting.
* The wash procedure pauses.	* The cloth sensor is detecting the cloth. It will start adding water after about 48 seconds.
* Select "SPIN" program, but it does not work.	* The program is setting the drain time. A certain period is needed before it starts spinning.
* The pusaltor pauses during washing , rinsing or adding water.	* It is to avoid splashing during water filling.
* There may be some water flowing out of the drain hose in the first use of the machine.	* It is the water remained in the performance inspection by the factory.
* When the power plug is inserted,computer board indicator is switched on,and the machine starts working.	* It is the special resume function. In the case of power failure or the power plug is loose during washing, the machine can save the running program, and resume the program after the power supply is recobered. You do not need to set the program again.
* The actual heating temperature may have discrepancy with the setting level.	* This is the normal phenomenon .The actual heating temperature is also influenced by the atmosphere temperature, the water temperature for wash and the water hardness.

Packing list

Name	Quantity	Storage position
● User's manual	● One	● Inside the document bag
● Warranty manual	● One	● Inside the document bag
● Components of the water inlet hose  <p>The end connecting to the washing machine inlet hose and the water faucet</p> <p>The end connecting to the water inlet hose joint</p> <p>Water inlet hose (1 piece)</p> <p>Water inlet hose joint (1 piece)</p>	● One	● Inside the accessory bag
● Bottom plate 	● One	● Between the upper cushion of the washing machine package and the upper seal of the package carton
● Tapping screws 	● Eight	● Inside the accessory bag
● Inner cover component 	● One	● Inside the accessory bag
● Fuzzy Computerized Automatic Washing Machine	● One	

Specification

Rated washing / spinning capacity	6.0kg/6.0kg
Water level/Water quantity (about)	1/12L、2/16L、3/20L、4/25L、5/29L、6/33L、7/38L、8/42L、9/47L、10/50L
Injection pressure	0.03MPa~0.78MPa

Free Manuals Download Website

<http://myh66.com>

<http://usermanuals.us>

<http://www.somanuals.com>

<http://www.4manuals.cc>

<http://www.manual-lib.com>

<http://www.404manual.com>

<http://www.luxmanual.com>

<http://aubethermostatmanual.com>

Golf course search by state

<http://golfingnear.com>

Email search by domain

<http://emailbydomain.com>

Auto manuals search

<http://auto.somanuals.com>

TV manuals search

<http://tv.somanuals.com>