



Contact Information

Hamilton Buhl
80 Little Falls Road
Fairfield, New Jersey 07004
Phone: 1-800-631-0868
Fax: 1-800-398-1812
Email: Sales@HamiltonBuhl.com
Business Hours: M-F 9:00 am to 5:00 pm E.S.T.
www.HamiltonBuhl.com



USER'S GUIDE



ISD-SB37

Bluetooth 37" HD Sound Bar with Built-in Subwoofer

Warnings and Precautions

CAUTION: TO PREVENT ELECTRIC SHOCK, MATCH WIDE BLADE OF PLUG TO WIDE SLOT, FULLY INSERT.

WARNING: To reduce the risk of fire or electric shock, do not expose this apparatus to rain or moisture.

AVERTISSEMENT: Pour réduire le risque d'incendie ou de choc électrique, ne pas exposer cet appareil sous la pluie et l'humidité.

CAUTION: Use of any controls or adjustments or performance of procedures other than those herein specified may result in hazardous radiation exposure.

WARNING: Changes or modifications to this unit not expressly approved by the party responsible for compliance could void the user's authority to operate the equipment.

WARNING: Do not place the unit on top of any soft, porous, or sensitive surfaces to avoid damaging the surface. Use a protective barrier between the unit and surface to protect the surface.

WARNING: Use of this unit near fluorescent lighting may cause interference regarding use of the remote. If the unit is displaying erratic behavior move away from any fluorescent lighting, as it may be the cause.

CAUTION: Danger of explosion if battery is incorrectly replaced. Replace only with the same or equivalent type.

PRÉCAUTION: Danger d'explosion si les piles sont remplacées de façon incorrect. Remplacer les piles seulement par le même type de pile ou l'équivalent.

WARNING: The battery, batteries, and battery pack shall not be exposed to excessive heat such as sunshine, fire, or the like.

WARNING: Lithium batteries, like all rechargeable batteries are recyclable and should be recycled or disposed of in normal household waste. Contact your local government for disposal or recycling practices in your area. They should never be incinerated since they might explode.

WARNING: Shock hazard - Do Not Open.

AVIS: RISQUE DE CHOC ÉLECTRIQUE - NE PAS OUVRIR

Mains Plug or Direct plug-in adapter is used as disconnect device and it should remain readily operable during intended use. In order to disconnect the apparatus from the mains completely, the Mains Plug or Direct plug-in adapter should be disconnected from the mains socket outlet completely.

La fiche d'alimentation ou adaptateur de courant est utilisé comme dispositif de déconnexion et doit rester accessible pendant l'utilisation. Pour mettre l'appareil hors tension, la fiche ou adaptateur de courant doit être débranché de la prise de courant.



WARNING: TO REDUCE THE RISK OF ELECTRIC SHOCK, DO NOT REMOVE COVER (OR BACK). NO USER-SERVICEABLE PARTS INSIDE. REFER SERVICING TO QUALIFIED SERVICE PERSONNEL.



The lightning flash with arrowhead symbol, within an equilateral triangle, is intended to alert the user to the presence of uninsulated "dangerous voltage" within the product's enclosure that may be of sufficient magnitude to constitute a risk of electric shock to persons.



The exclamation point within an equilateral triangle is intended to alert the user to the presence of important operating and maintenance (servicing) instructions in the literature accompanying the appliance.

Learn Feature

Understanding the Learn feature

What is the Learn feature?

The Learn feature captures remote commands from your television remote, and teaches your bar speaker to operate when these commands are pressed. Power, volume and mute are a few examples of commands that the bar speaker can learn.

Why use the Learn feature?

Teaching the bar speaker remote commands will reduce the number of remotes needed, save time searching for remote codes, and improve the ease of operation.

Using the Learn Feature

1. With the power Off, press the **Learn** button on the unit.
2. Press the button you desire to be learned on the included remote.

An indicator will flicker red.

For example: Volume+

The red light will continue to flicker, and another indicator will display a blue light.

3. Press the corresponding button on your remote.
4. Press the **Learn** button on the unit.
5. The programmed button on your remote will now be able to control your sound bar.

The red light will continue to flicker, and another indicator will display a green light.

Note: It is necessary to program each button i.e. channel and volume + and - separately.

To start over, press and hold the learn key for over 3 seconds. If the sound bar has failed to learn a command, all the LED indicators will display a light for two seconds to signal the learning function has been reset.

Note: Not all functions of the sound bar will be available through your own remote control, such as bass and treble. Use the included remote for these functions.

Bluetooth

Pairing a Bluetooth Device for the First Time

1. Power on the unit by pressing the **Power** button.
2. Press the **Source** button repeatedly to enter Bluetooth mode, indicated by a blue light.
3. Press the **Pairing** button on the side of the unit.

The Pairing Indicator will flash blue quickly.

When pairing, remain within 3 feet of the unit.

4. Using the native controls on your Bluetooth device, select the ISD-SB37 in your Bluetooth settings to pair.

If your device requests a password, enter the default password "0000".

Refer to the user's manual for your specific device for instructions on pairing and connecting Bluetooth devices.

5. When successfully paired and connected, a beep will issue from the unit and the **Pairing Indicator** will display a solid blue light.

After initial pairing, the unit will stay paired unless unpaired manually by the user or erased due to a reset of the device.

If your device should become unpaired or you find it is unable to connect, repeat the above steps.

Playing Audio Wirelessly

1. Follow the instructions for [Pairing a Bluetooth Device](#).
2. Press the **BT** button on the remote to switch to Bluetooth Mode.
3. Use the native controls on the connected Bluetooth Device to select a track.
4. To play, pause or skip the selected track, use the native controls on the connected Bluetooth Device.
5. Audio played through the connected Bluetooth device will now be heard through the speakers.

Important Safety Instructions

1. Read these Instructions.
2. Keep these Instructions.
3. Heed all Warnings.
4. Follow all instructions.
5. Do not use this apparatus near water.
6. Clean only with a dry cloth.
7. Do not block any ventilation openings. Install in accordance with the manufacturer's instructions.
8. Do not install near any heat sources such as radiators, heat registers, stoves, or other apparatus (including amplifiers) that produce heat.
9. Do not defeat the safety purpose of the polarized or grounding - type plug. A polarized plug has two blades with one wider than the other. A grounding type plug has two blades and a third grounding prong. The wide blade or the third prong are provided for your safety. When the provided plug does not fit into your outlet, consult an electrician for replacement of the obsolete outlet.
10. Protect the power cord from being walked on or pinched particularly at plugs, convenience receptacles, and the point where they exit from the apparatus.
11. Only use attachments/accessories specified by the manufacturer.



Use only with a cart, stand, tripod, bracket, or table specified by the manufacturer, or sold with the apparatus. When a cart is used, use caution when moving the cart/apparatus combination to avoid injury from tip-over.

13. Unplug this apparatus during lightning storms or when unused for long periods of time.
14. Refer all servicing to qualified service personnel. Servicing is required when the apparatus has been damaged in any way, such as power-supply cord or plug is damaged, liquid has been spilled or objects have fallen into the apparatus, the apparatus has been exposed to rain or moisture, does not operate normally, or has been dropped.

Special note: When placing your unit on a lacquered or natural finish, protect your furniture with a cloth or other protective material.

FCC Warnings

WARNING: Changes or modifications to this unit not expressly approved by the party responsible for compliance could void the user's authority to operate the equipment.

NOTE: This equipment has been tested and found to comply with the limits for a Class B digital device, pursuant to Part 15 of the FCC Rules. These limits are designed to provide reasonable protection against harmful interference in a residential installation. This equipment generates, uses, and can radiate radio frequency energy and, if not installed and used in accordance with the instructions, may cause harmful interference to radio communications. However, there is no guarantee that interference will not occur in a particular installation. If this equipment does cause harmful interference to radio or television reception, which can be determined by turning the equipment off and on, the user is encouraged to try to correct the interference by one or more of the following measures:

- Reorient or relocate the receiving antenna.
- Increase the separation between the equipment and receiver.
- Connect the equipment into an outlet on a circuit different from that to which the receiver is connected.
- Consult the dealer or an experienced radio/TV technician for help.

Additional Warnings

The apparatus shall not be exposed to dripping or splashing and that no objects filled with liquids, such as vases, shall be placed on apparatus.

L'appareil ne doit pas être exposé aux écoulements ou aux éclaboussures et aucun objet ne contenant de liquide, tel qu'un vase, ne doit être placé sur l'objet.

Battery shall not be exposed to excessive heat such as sunshine, fire or the like.

Les piles ne doivent pas être exposées à de forte chaleur, tel qu'à la lumière du soleil, au feu ou autres choses de semblable.

Caution marking is located at the rear or bottom of the apparatus.

Attention marquage est situé sur le panneau arrière ou inférieur de l'unité.

The marking information is located at the rear or bottom of apparatus.

Le marquage est situé sur le panneau arrière ou inférieur de l'unité.



This symbol indicates that this product incorporates double insulation between hazardous mains voltage and user accessible parts.

ISD-SB37

Features

- 37" length
- Supports Bluetooth v2.1
- Supports profile A2DP (Advanced Audio Distribution Profile)
- Digital volume control
- FM Radio (PLL)
- Remote
- Learning remote control capability
- Bass controls
- Treble controls
- Preset EQ
- Optical digital audio input
- 3.5mm audio input
- Subwoofer output
- Stereo RCA audio inputs
- LED pairing indicator
- LED source indicators
- LED power indicator
- Wall mountable
- Wireless range: 33 feet
- AC power input: requires an AC/DC power adapter (included)

Includes

- Remote control: requires a CR2025 battery (pre-installed)
- RCA stereo audio cable
- Wall-mount hardware and instructions
- AC/DC power adapter

Setup

Power

AC power input: requires an AC/DC power adapter (included)

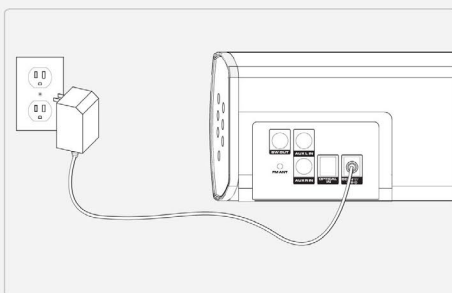

Remote

Requires a CR2025 battery (pre-installed)

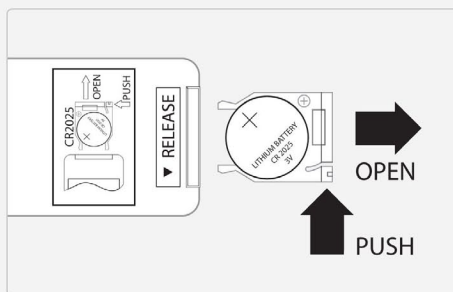

LED Indicators

Status	Indicator
Power Off	No Light
Optical Mode	Amber Light
Aux In Mode	White light
Line In Mode	White Light
Radio Mode	Green Light
Bluetooth Ready	Flashing Blue Light
Bluetooth Connected	Blue Light

Mounting

We recommend having this bar speaker professionally mounted.

Radio and Line In

Tuning the Radio

1. Press the **Source** button repeatedly to enter FM Radio Mode, indicated by a green light.
2. Press the **Scan** button on the remote.
3. The bar speaker will scan for all available stations, and store them.
4. Press the **Channel +/-** buttons to browse through stored stations.

Using the Line In

1. Plug one end of a 3.5 mm audio input cable into the **Line In** on the unit.
3.5 mm audio input cable not included.
Before use, disconnect any cables connected to the Stereo RCA Inputs.
2. Plug the other end of the cable into the audio output/headphone output on an MP3 Player or other audio source.
3. Press the **Power** button to power the unit on.
4. Press the **Source** button repeatedly to enter Aux/Line In Mode, indicated by a white light.
5. Audio played through the connected device will now be heard through the speakers.

Audio Inputs & Subwoofer Output

Using the Stereo RCA Inputs

When connecting two products using an RCA Cable, match the colored ports with the same colored connection.

Before use, disconnect any cables connected to the Line In.

1. Connect the RCA Cable to the RCA Stereo Inputs located on the back of the unit, and to the audio outputs on the television.
2. Press the **Power** button to power on the unit.
3. Press the **Source** button repeatedly to enter Aux/Line Mode, indicated by a white light.
4. Audio played through the television will now be heard through the speakers.

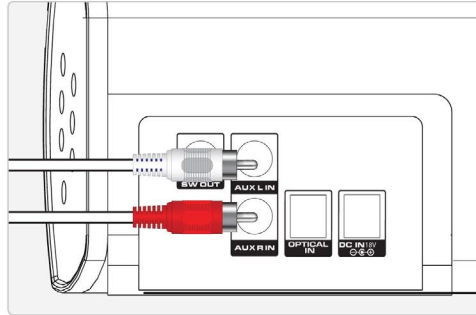

Using the Optical Input

You will need: An audio source with an Optical Audio Output and a Digital Optical Audio Cable (not included)

1. Connect the Digital Optical Audio Cable to the optical output on the audio source and to the **Optical Input** on the speaker bar.
2. Press the **Power** button to power the unit on.
3. Press the **Source** button repeatedly to switch to SPDIF Mode, indicated by an amber light.
4. Using the native controls on your connected device, make sure the audio settings are set to PCM or Optical Audio and are turned On.
5. Audio from the connected audio source will now be played through the speakers.

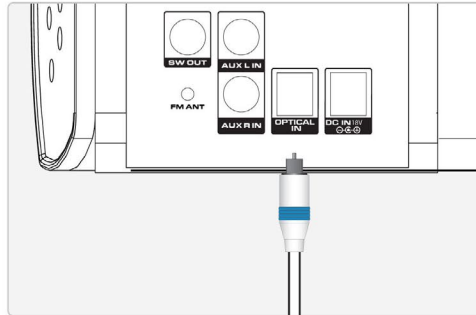

Using the Subwoofer Output

1. Use an RCA cable (included) to connect an external subwoofer to the **Subwoofer Output**.
2. When audio is played through any source, the bar speaker will automatically use the connected subwoofer.

Table of Contents

Warnings and Precautions	2
Important Safety Instructions	3
ISD-SB37	4
Features	
Setup	4
Power	
LED Indicators	
Remote	
Mounting	
Includes	
Table of Contents	5
Introduction	6
Audio Inputs & Subwoofer Output	8
Using the Stereo RCA Inputs	
Using the Optical Input	
Using the Subwoofer Output	
Radio and Line In	9
Tuning the Radio	
Using the Line In	
Bluetooth	10
Pairing a Bluetooth Device for the First Time	
Playing Audio Wirelessly	
Learn Feature	11
Understanding the Learn feature	
Using the Learn Feature	
Company Information	12
International Support	
Contact Information	
Warranty	
Green Initiative	

Introduction

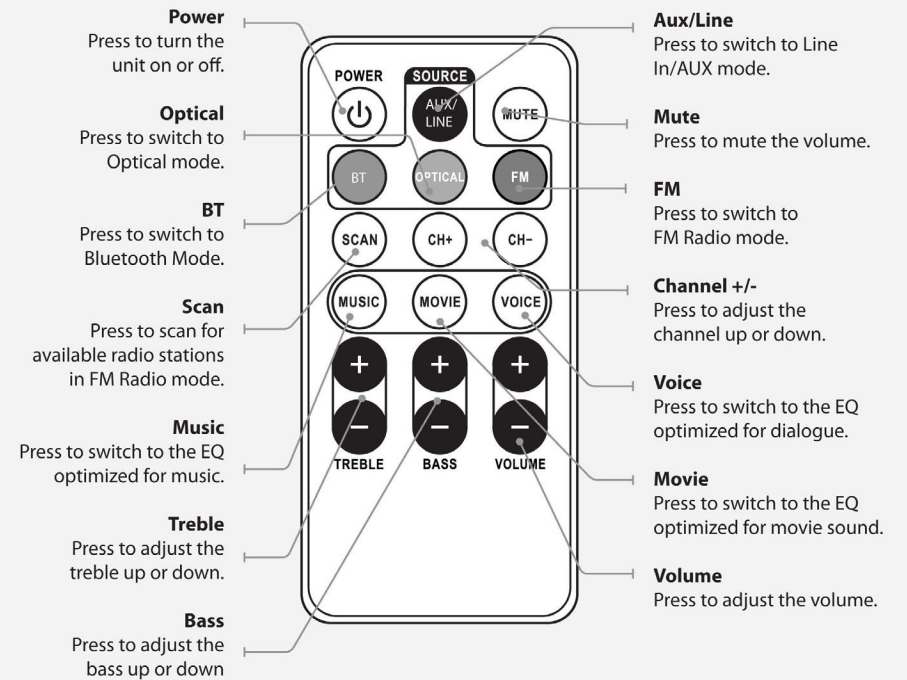
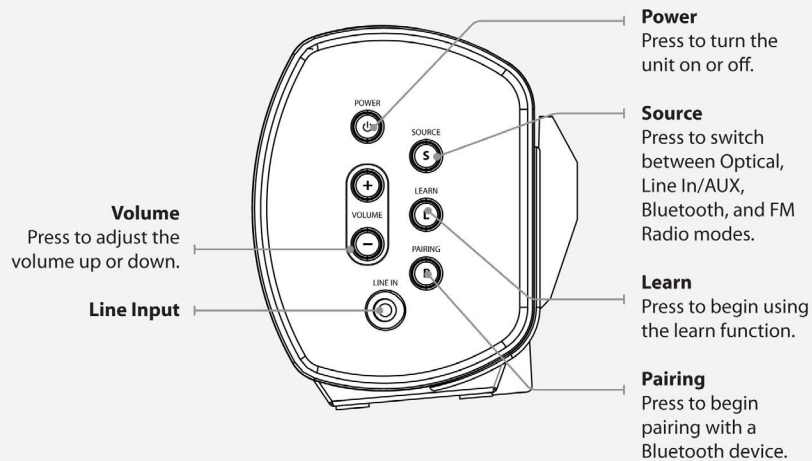
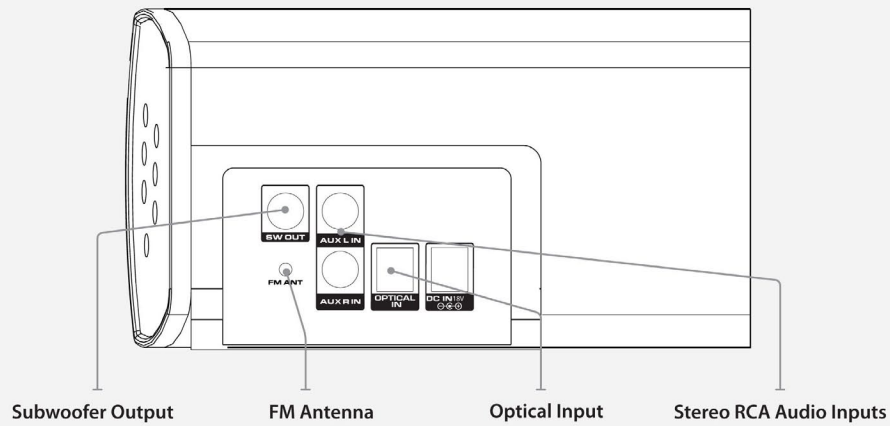

Free Manuals Download Website

<http://myh66.com>

<http://usermanuals.us>

<http://www.somanuals.com>

<http://www.4manuals.cc>

<http://www.manual-lib.com>

<http://www.404manual.com>

<http://www.luxmanual.com>

<http://aubethermostatmanual.com>

Golf course search by state

<http://golfingnear.com>

Email search by domain

<http://emailbydomain.com>

Auto manuals search

<http://auto.somanuals.com>

TV manuals search

<http://tv.somanuals.com>