

Operations Manual

ACT2000 All-Electric Actuator

SD-6008-03

This manual provides installation, maintenance, and operating instructions for the ACT2000 All-Electric Actuator.

Every attempt has been made to provide sufficient information in this manual for the proper operation and preventive maintenance of the actuator. It is recommended that the user read this manual in its entirety.

Operating the ACT2000 All-Electric Actuator in accordance with instructions herein ensures long term and reliable operation.

If additional information is required, please contact:

Marketing Department
Precision Engine Controls Corporation
11661 Sorrento Valley Road
San Diego, California 92121
(858) 792-3217 • (800) 200-4404
fax: (858) 792-3200
e-mail: peccntl@precisioneng.com

Table of Contents

Table of Contents	i
1 INTRODUCTION	1-1
1.1 Application	1-1
1.2 Mounting Provisions	1-1
1.3 Main Housing Assembly	1-2
1.4 Brushless DC Motor Assembly	1-3
1.5 Motor Control Electronics	1-3
1.6 Resolver Assembly	1-3
1.7 Linear Drive Mechanism	1-4
1.8 Power and Digital Harness	1-4
1.9 Identification Plate	1-5
2 FUNCTIONAL DESCRIPTION AND OPERATION	2-1
2.1 System Description	2-1
2.2 Electronic Description	2-1
2.3 Basic Operation and State Description	2-6
2.4 Health Monitoring	2-8
2.5 FAULT Alarm	2-9
2.6 OVERTEMP Alarm	2-10
2.7 Automatic Shutdown	2-10
2.8 ACT2000 Set-Up Parameters	2-11
3 INSTALLATION	3-1
3.1 Inspection	3-1
3.2 Environmental Considerations	3-1
3.3 Mechanical Installation	3-1
3.4 Electrical Installation	3-4
4 TROUBLESHOOTING	4-1
5 DECOMMISSIONING AND DISPOSAL	5-1
6 ACT2000 GENERAL SPECIFICATIONS	6-1
7 GLOSSARY	7-1

List of Figures

Figure 1-1: ACT2000 Pin Mounted	1-1
Figure 1-2: ACT2000 Flange Mounted	1-1
Figure 1-3: ACT2000 Cut-Away View	1-2
Figure 1-4: Typical Identification Plate	1-5
Figure 2-2: Typical Power Connection	2-3
Figure 2-3: Typical Discrete Command Connection	2-3
Figure 2-4: Typical Analog Input Connection	2-4
Figure 2-5: Typical Analog Output Connection	2-4
Figure 2-6: Typical Fault Alarm Connection	2-5
Figure 2-7: ACT2000 State Machine	2-7
Figure 3-1: ACT2000-590P Envelope	3-2
Figure 3-2: ACT2000-200F Envelope	3-3
Figure 3-3: ACT2000 Wiring Diagram	3-8

List of Tables

Table 2-1: ACT2000 Setup Parameters	2-12
Table 3-1: Power Harness Recommended Wire Size	3-5
Table 3-2: Digital Harness Recommended Wire Size	3-6
Table 3-3: ACT2000 Power Harness Wire List	3-7
Table 3-4: ACT2000 Digital Harness Wire List	3-9
Table 3-5: Power Supply Requirements	3-10
Table 4-1: ACT2000 Initial Installation Troubleshooting Chart	4-2
Table 4-2: ACT2000 In-Service Troubleshooting Chart	4-3
Table 4-3: ACT2000 Electrical Hook-Up Continuity Troubleshooting Chart	4-3

1 INTRODUCTION

This publication covers operation, installation and maintenance instructions for the ACT2000 Actuators manufactured by Precision Engine Controls Corporation.

1.1 Application

The ACT2000 All-Electric Actuator is designed to meet general industrial motion control requirements for high temperature hazardous locations. Typical applications include gas turbine guide vane and valve motion control.

1.2 Mounting Provisions

The ACT2000 can be pin or flange mounted. Figure 1-1 shows a pin-mounted actuator. Figure 1-2 shows a flange-mounted actuator. Other configurations can be provided. Please consult Precision Engine Controls Corporation.



Figure 1-1 ACT2000-590P Pin Mounted



Figure 1-2 ACT2000-200F Flange Mounted

The pin-mounted ACT2000 configuration includes a stainless steel machined clevis. The clevis is fully rotational to allow variable angular indexing as required for installation. The extension rod provides a female thread for user supplied end attachments. A spherical rod end bearing attachment is preferred.

The ACT2000 contains a brushless direct current (DC) motor-driven linear actuator with on-board digital motor control electronics. The primary actuator components are described in the balance of this section.

1.3 Main Housing Assembly

The main housing assembly contains a main housing, motor cover, extension rod bearing, and associated seals. See Figure 1-3. The main housing assembly is the primary structural system component and supports all the bearings, motor control electronics, motor cover, and mountings, which forms the explosion-proof containment.

In order to provide main bearing thermal dimensional stability, the housing is fitted with a stainless steel liner. The liner is permanently installed into the aluminum main housing. A retaining ring is included for redundant retention.

The main housing contains rigid mechanical stops to prevent extension rod travel beyond the design specification.

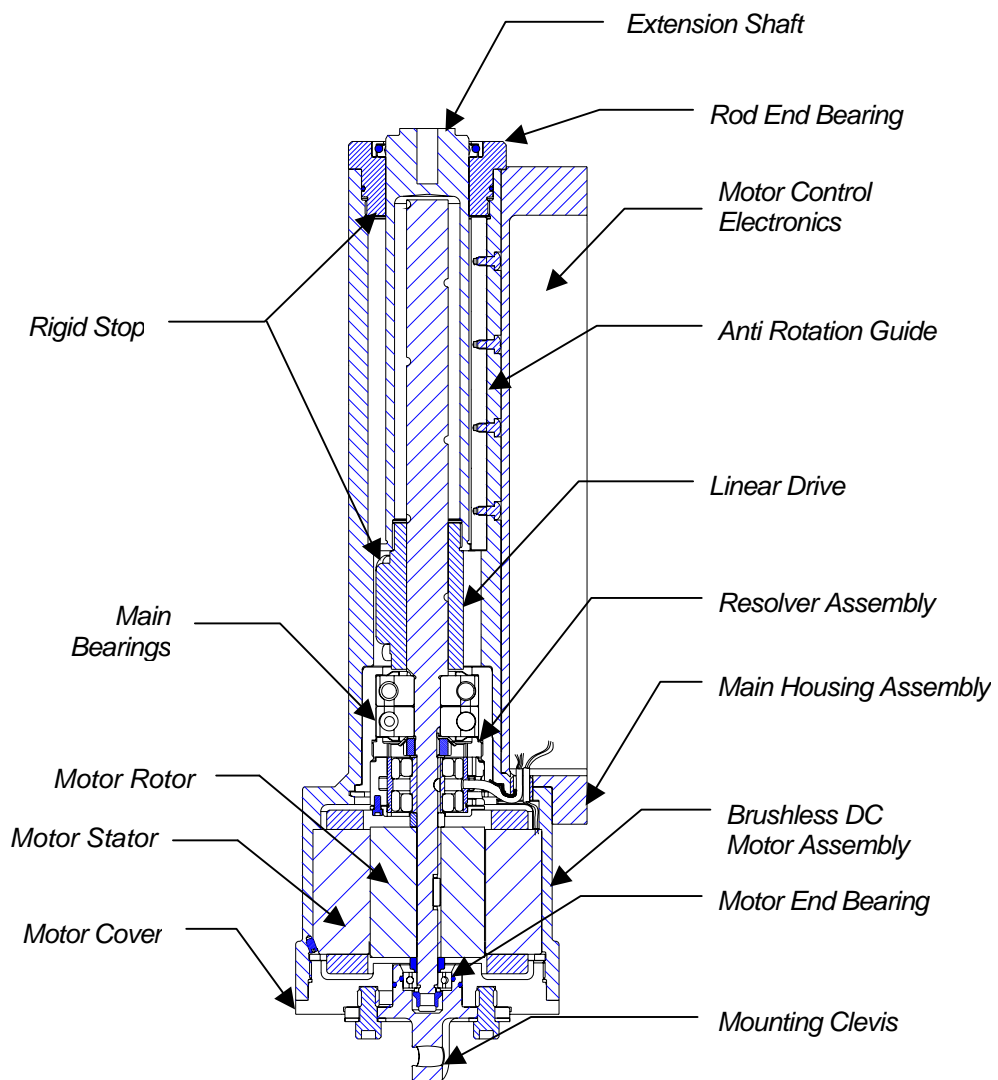

Figure 1-3 ACT2000 Cut-Away View

1.4 Brushless DC Motor Assembly

A brushless DC motor powers the ACT2000 linear drive mechanism. The DC motor contains a stator and rotor. See Figure 1-3

Motor Stator

The motor stator is attached to the main housing by a pre-loaded wave spring and screws. Thermistors are embedded in the stator windings to monitor winding temperatures. The motor electrical power and thermistor wires pass from the motor through a conduit into the electronics housing.

Motor Rotor

The motor rotor is locked to the ball screw shaft via a straight key. The motor rotor contains powerful magnets that align with the energized stator windings thereby creating torque and shaft rotation.

1.5 Motor Control Electronics

The motor control electronics (MCE) are contained within the main housing electronics enclosure. The MCE includes harnesses, heat sink, digital and driver component assemblies (CA).

The MCE electronics communicate with the user's controller through analog and serial interfaces. The MCE controls the brushless DC motor, to position the actuator based on position feedback from the resolver.

 **Note:** The digital board analog and discrete interfaces are electrically isolated. The MCE serial interface is NOT electrically isolated.

1.6 Resolver Assembly

A Brushless, non-contacting resolver is the primary ACT2000 feedback sensor. A sinusoidal feedback signal is provided from the resolver to the motor control electronics. A sinusoidal signal from the MCE provides the resolver excitation. The resolver includes a stator and rotor. See Figure 1-3

Resolver Stator

The resolver stator is clamped to the main housing between the main bearing retaining nut and resolver retainer. The resolver stator angular position relative to the rotor is adjustable. Electrical wires from the resolver are reeled in the resolver adapter to allow rotation. The resolver wires, along with the motor and thermistor leads, are routed through a conduit into the electronics housing.

Resolver Rotor

The resolver rotor is mounted by a key to a ball screw shaft. As the rotor rotates, the stator transformer output signal provides shaft rotation information to the MCE.

1.7 Linear Drive Mechanism

The Linear Drive Mechanism converts the rotary motion of the Motor Assembly to linear actuator motion. The core of the mechanical drive system is the linear ball screw drive containing a screw shaft, ball bearing fitted nut, extension rod and main duplex thrust bearings.

Screw Shaft

The thrust bearings, motor rotor, motor end bearing, and resolver rotor are mounted directly to the screw shaft. A ball bearing track is machined into the screw shaft.

Ball Nut

As the screw shaft rotates, the ball nut translates in an axial direction depending on shaft rotation.

Extension Rod and Bearings

The extension rod is threaded on the ball nut. As the ball nut translates, the extension rod moves in and out of the ACT2000 main housing.

The extension rod support bearing is provided for lateral support. Thrust and radial loads are transferred from the extension rod through the ball nut to the main preloaded duplex thrust bearings. The thrust bearings transfer the loads to the main housing by the main bearing and shaft retaining nuts.

A motor end bearing is provided for additional shaft radial stability. The resolver rotor, motor rotor, motor bearing, and spacers are stacked on the ball screw shaft and retained by a single nut. This arrangement prevents actuator axial loads from passing through the resolver rotor and motor rotor.

1.8 Power and Digital Harness

A four-wire electrical harness with two (2) meter free leads provides the ACT2000 electrical power inputs. The four-wire harness allows for redundant electrical inputs.

A seventeen-wire electrical harness with ninety (90) inch free leads provides ACT2000 signal interface. Contained within this seventeen-wire harness are discrete commands, analog commands, feedback, and serial interface wires.

1.9 Identification Plate

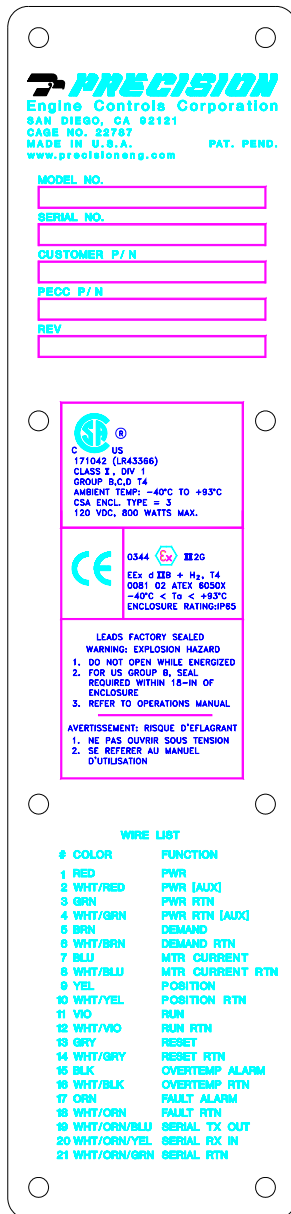

A product identification plate is attached to the actuator housing assembly. Figure 1-4 shows a typical identification plate.

The identification plate lists model designation, product part number, revision and unit serial number. Hazardous area operation, certification and electrical wiring interface information is also provided.

Figure 1-4: Typical Identification Plate

P-PRECISION

INTENTIONALLY BLANK

2 FUNCTIONAL DESCRIPTION AND OPERATION

This section describes system functions employed in the ACT2000 Electric Actuator.

2.1 System Description

The ACT2000 is a closed loop servo system containing motor control electronics (MCE) and a brushless DC motor driven ball screw actuator. The actuator closes its own control loop on an internally generated position feedback. Thus, the actuator continuously modulates its position and provides precise positioning.

The ACT2000 requires only 120VDC power, 4-20 mA position demand, and discrete RUN command to achieve basic operational capability. The ACT2000 provides position and motor current feedback via integral 4-20 mA circuits. Once 120VDC power and RUN command are supplied, the actuator will track position demand.

2.2 Electronic Description

The ACT2000 electric actuator incorporates digital motor control electronics. The electronic system block diagram is shown in Figure 2-1. Contained within the motor control electronics (MCE) are digital and driver CA. The digital and driver component assemblies contain analog to digital converters, digital signal processor (DSP), application specific integrated circuit (ASIC) and power supplies.

Digital CA

The digital CA interfaces with a user-provided control system that is typically a programmable logic controller (PLC). The digital CA accepts analog position and discrete RUN and RESET commands from the control system. The digital CA provides analog position and motor current feedback to the control system. In addition, the digital CA provides discrete FAULT and OVERTEMP alarms to the control system.

The digital CA receives position feedback from the resolver and current feedback from the driver CA. The digital CA can provide speed, temperature, voltage and other relevant information through the serial interface using ActWiz software. Contact Precision Engine Controls for ActWiz software.

 **Note:** The digital board analog and discrete interfaces are electrically isolated. The RS232C serial interface is NOT electrically isolated.

Driver CA

The driver CA interfaces with the user's power supply; typically a 120 VDC battery. The driver CA controls current to the brushless DC motor and provides precise voltage and current inputs to the digital CA.

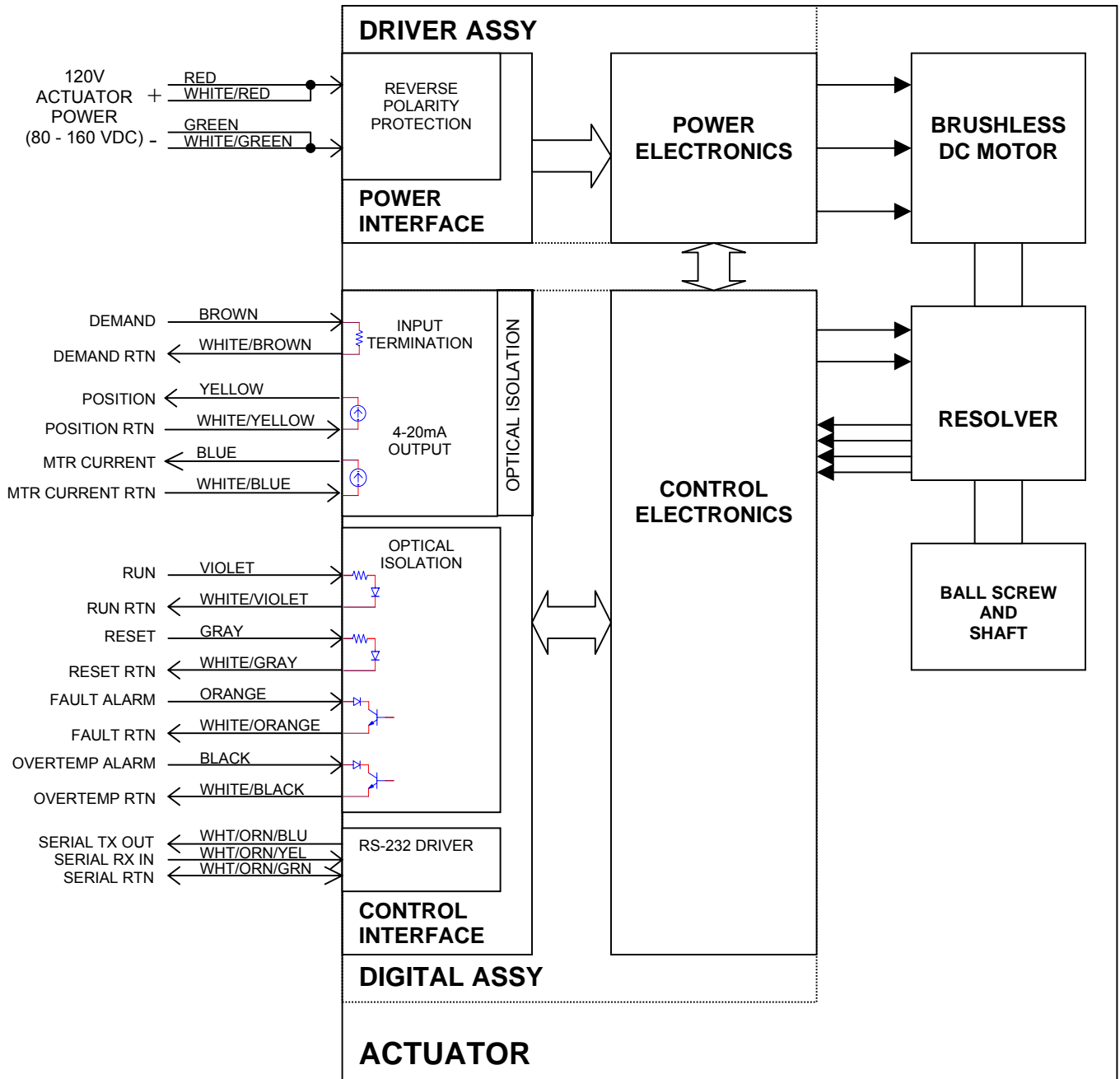

Figure 2-1: ACT2000 Electronics System Block Diagram

2.2.1 Power

The ACT2000 operates on nominal 120 VDC, user-provided input voltage via the four-wire power harness. Refer to Figure 2-2 for typical connection. Refer to section 6 for specification values.

Primary power wires.

- +120 VDC is connected to the RED wire.
- The 120 VDC return wire is GREEN.

Redundant power wires:

- +120 VDC is connected to the WHITE/RED wire.
- 120 VDC return wire is WHITE/GREEN.

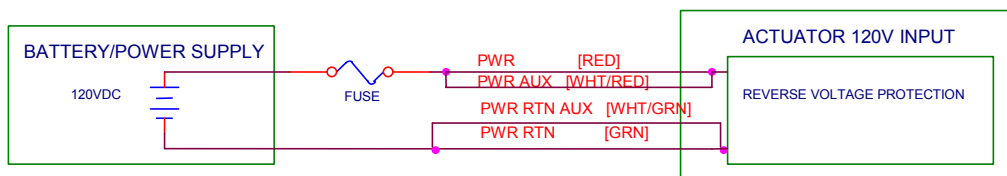

Figure 2-2: Typical Power Connection



WARNING:

Shock Hazard – Both the 120 VDC power and auxiliary wires should be connected. If only the primary power wires are connected, the 120 VDC auxiliary power wires are electrically “hot” and must be insulated on the ends.



Note: If a 120 VDC power supply is used, it must have at least 50,000 uF internal capacitance. See Power Supply Requirements (Table 3-5).

2.2.2 Discrete Commands

The ACT2000 accepts two discrete, two-wire external commands: RUN and RESET. The commands are 24 VDC ON (High) and 0 VDC OFF (Low). Refer to Figure 2-3 for typical connection. Refer to Section 6 for specification values.

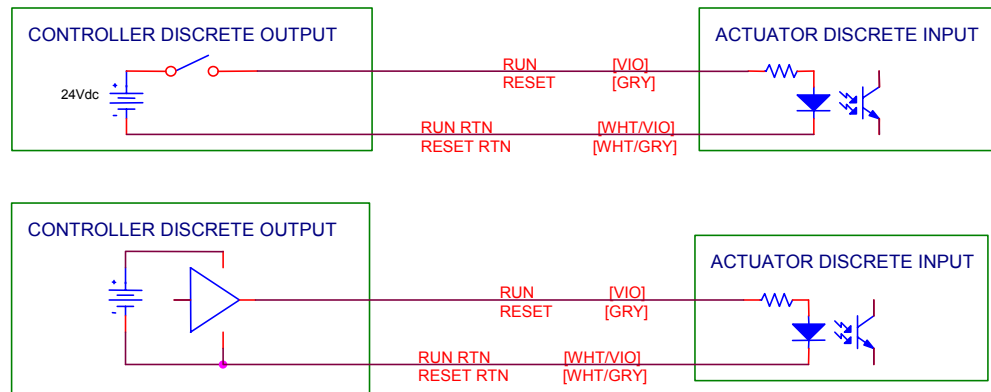

Figure 2-3: Typical Discrete Command Connection

Run Command

The RUN command is a user provided discrete input to the ACT2000 which allows the actuator to track position demand. The +24 VDC signal shall be provided on the VIOLET wire. The signal return shall be provided on the WHITE/VIOLET wire.

Reset Command

The RESET command is a user provided discrete input to the ACT2000, which causes the actuator to go through the initial homing sequence and reset all internal position indicators. RUN and position demand inputs are ignored during the RESET command. The +24VDC signal shall be provided on the GRAY wire. The signal return shall be provided on the WHITE/GRAY wire.

2.2.3 Analog Inputs/Outputs

The ACT2000 receives analog position demand from an external, user-provided controller and provides analog actuator position and motor current feedback. Refer to Figures 2-4 and 2-5 for typical connection. Refer to Section 6 for load specification values.

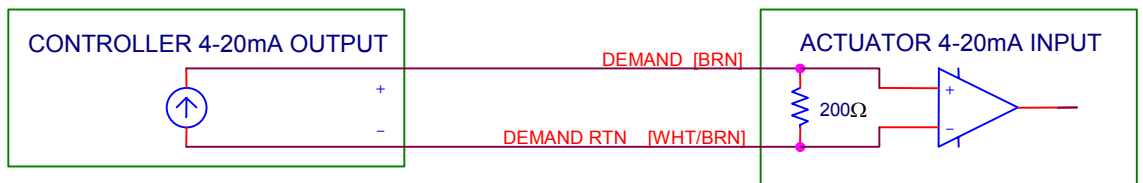

Figure 2-4: Typical Analog Input Connection

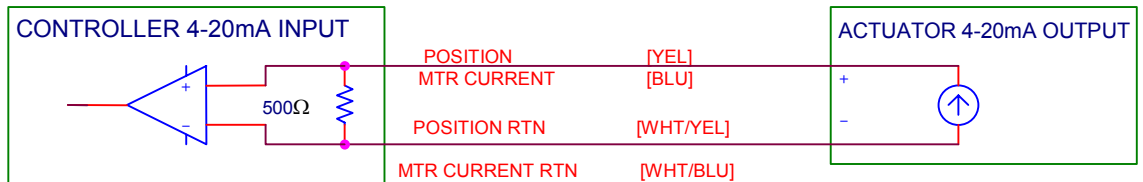

Figure 2-5: Typical Analog Output Connection

Position Demand

The position demand is a 4-20mA user provided analog input that causes the actuator to a command position. The position demand shall be provided on the BROWN wire. The position demand return shall be provided on the WHITE/BROWN wire. The position demand internal impedance is 200 ohms. The position demand requires a sourcing current.

Position Feedback

The ACT2000 provides actuator analog position feedback to the user. This internally generated feedback signal is proportional to the actual position.

The actuator position feedback is provided on the YELLOW wire. The actuator position feedback return is provided on the WHITE/YELLOW wire. The expected external impedance is 250 ohms. The maximum external impedance is 500 ohms. Typically, the position feedback will be within ± 0.1 mA of the position demand.

Motor Current Feedback

The ACT2000 provides motor current feedback to the user. This internally generated feedback signal is proportional to actuator load. 4mA represents no load on the actuator.

The motor current feedback is provided on the BLUE wire. The motor current feedback return is provided on the WHITE/BLUE wire. The expected external impedance is 250 ohms. The maximum external impedance is 500 Ohms.

2.2.4 Fault Alarms

The discrete alarm outputs are opto-isolated electronic switches that are normally closed. The user controller provides 24 VDC with current limiting resistor, to complete the circuit. If a FAULT or OVERTEMP alarm has occurred, the switch opens thereby communicating an alarm to the user's controller. Refer to Figure 2-6 for typical connection. Refer to Section 6 for load specification values.

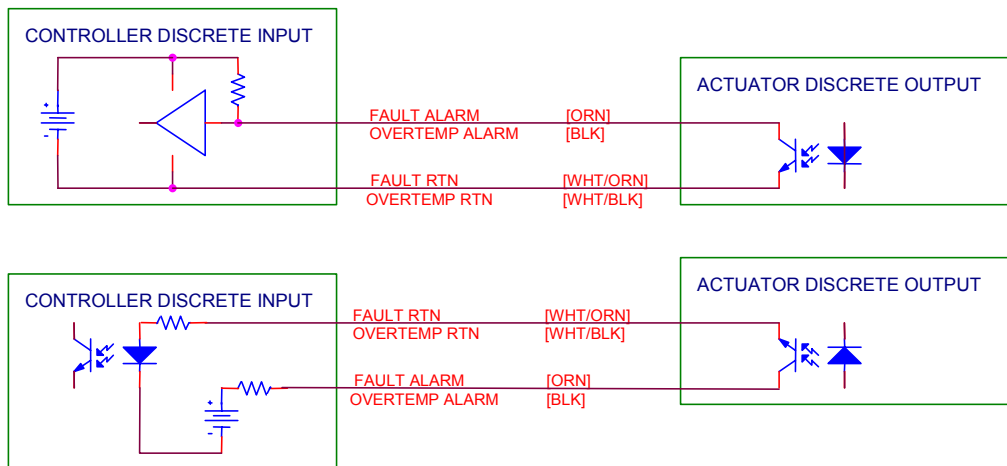

Figure 2-6: Typical Fault Alarm Connection

The FAULT alarm is provided on the ORANGE wire. The FAULT alarm return is provided on the WHITE/ORANGE wire.

The OVERTEMP alarm is provided on the BLACK wire. The OVERTEMP alarm return is provided on the WHITE/BLACK wire.

WARNING:

Property Damage – Connection of 24 VDC power across the actuator discrete output will cause electrical failure of the output. Series resistance should be added to the 24 VDC output from the controller to limit the current to 25mA max.



2.2.5 RS232 Communications

RS232 serial communications is achieved with user-provided connection to the Serial Rx In, Serial Tx Out and Serial Rtn wires.

- The Serial RX In wire is WHITE/ORANGE/YELLOW.
- The Serial Tx Out wire is WHITE/ORANGE/BLUE.
- The Serial Rtn wire is WHITE/ORANGE/GREEN.

The RS232C type interface is used to communicate with the ACT2000 using ActWiz software.

2.3 Basic Operation and State Description

The basic operation of the ACT2000 is described in the following sections. The Power-Up mode section covers the Power Up/Reset and the Set-Up states. The Run Mode section covers the Home/Dead Band, Holding Motor Current and the Run states.

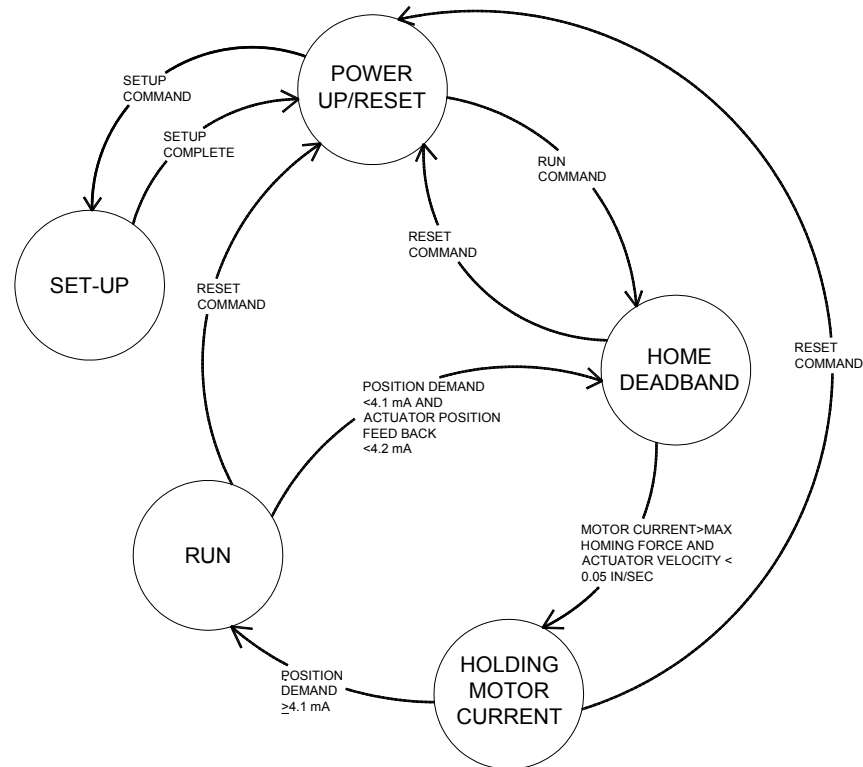

Figure 2-7: ACT2000 State Machine

2.3.1 Power-Up Modes

When 120 VDC is applied to the ACT2000, the on-board DC converter supplies power to the driver and digital boards. The ACT2000 will operate with voltages ranging from 80 VDC to 160 VDC.

Power-Up/Reset State

Once the digital signal processor (DSP) receives required voltage, it starts the firmware program and enters the POWER-UP/RESET state. See Figure 2-7. The program checks electronics health, clears system registers and retrieves set-up parameters from the electrically erasable programmable read only memory (EEPROM).

Once the program is complete with the health check, it waits for either the RUN, RESET or SET-UP command.

- If the ACT2000 receives a SET-UP command from the ActWiz software (through the RS232 interface), firmware program will transition to the SET-UP state.

- If the ACT2000 receives a discrete RUN command, the firmware program will transition to the HOME DEAD BAND state.
- If the ACT2000 receives a discrete RESET command, the firmware program will continuously reset. The actuator will not function and will remain in the power-up/reset state.



WARNING:

Property Damage Hazard – Always remove RUN command during Set-Up state. If a RUN command is given during program download, the actuator will not respond until download is complete.

Set-Up State

The ACT2000 communicates with the user in this state. See Figure 2-7. Contact Precision Engine Controls for a copy of ActWiz software in order to communicate with the ACT2000.

In this state, a set-up file can be uploaded or downloaded. A Fault file can also be uploaded using the ActWiz software. Please see ActWiz software manual for more information.

The ACT2000 can only enter this state via POWER-UP/RESET. The ACT2000 enters this state via a SET-UP command received via the RS232 interface.

The actuator will leave this state after a file has been uploaded or downloaded. The ACT2000 will not hold position while in this state.



WARNING:

Property Damage Hazard – The ACT2000 will not hold position when communicating with ActWiz software. Ensure there is no load on the extension rod when communicating with the actuator.

Once the ACT2000 has completed the power-up operations, it will wait for a RUN command. The actuator will not move or hold load until a RUN command is received.

2.3.2 Run Modes

Upon receipt of RUN command, the ACT2000 firmware program will transition to one of the run modes listed below.



Note: As a safety feature, the ACT2000 will not move without a RUN command.

Home/Dead Band State

The HOME/DEAD BAND state is used to find HOME position after a POWER-UP/RESET. See Figure 2-7. The firmware program will transition to HOME/DEADBAND upon receipt of RUN command.

While in the HOME/DEAD BAND state, the actuator moves at constant velocity (homing velocity) and direction (extend or retract) until a mechanical stop is found.



Note: If RUN command is removed, the actuator will not function.

When the mechanical stop is found (actuator velocity less 0.05 inches per second), the MCE will apply the maximum homing force. Once the maximum homing force is applied, the firmware program will transition to the HOLDING MOTOR CURRENT state.

Holding Motor Current State

In the HOLDING MOTOR CURRENT state, the MCE applies a constant HOLDING FORCE, as long as, the position demand is $> 2\text{mA}$ and $< 4.1\text{mA}$. See Figure 2-7. This feature allows the HOME position to thermally expand or contract without damaging the ACT2000.

If the actuator firmware program entered the HOME/DEAD BAND state from POWER-UP/RESET, the firmware program will immediately define the current actuator position as HOME (zero).

The actuator firmware program will also enter this state from RUN if the position demand is $< 4.1\text{mA}$ and position feedback is $< 4.2\text{mA}$.

 **Note:** If RUN command is removed or position demand $\leq 2\text{ mA}$, the actuator will go to the STOP position.

Run State

The RUN state is the ACT2000 normal operating mode. See Figure 2-7. In the RUN state, the actuator tracks position demand and will apply up to the maximum force to reach the demand position.

The actuator firmware program enters this state from the HOLDING MOTOR CURRENT state if the position demand is $\geq 4.1\text{mA}$. The actuator firmware program will remain in this state as long as the demand is greater than 4.1mA .

 **Note:** If RUN command is removed or position demand $\leq 2\text{ mA}$, the actuator will go to the STOP position.

Stop Position

The STOP position is a user defined, fail-safe position. The STOP position is a set-up parameter stored in the EEPROM. The STOP position may be anywhere between HOME (zero position) and maximum span.

The STOP position is not a state per se. However, while in the STOP position the ACT2000 firmware program will track and hold the position defined in the Set-Up parameters.

The actuator will move to the STOP position if RUN command is removed during any of the running modes or position demand is $\leq 2\text{ mA}$ (signal loss).

2.4 Health Monitoring

The firmware program continuously monitors system health while the ACT2000 is powered.

If any of the health parameters are out of the normal operating range, the MCE outputs a discrete FAULT alarm to the user's controller. The actuator firmware also captures the fault data in the EEPROM.

If the motor or electronics temperature is above the normal operation range, the MCE outputs a separate OVERTEMP alarm. The actuator firmware also captures the fault data in the EEPROM.

If any of these faults have occurred, the user should shut down the ACT2000 to investigate the failure cause

If the ACT2000 is operational, a fault file can be uploaded using ActWiz software via the RS232 interface. The fault file will provide fault information and possible cause.

2.5 FAULT Alarm

The FAULT alarm is a discrete output from the ACT2000. The FAULT circuit is CLOSED in the normal operating condition.

During normal operation, the ACT2000 monitors system health. If the ACT2000 detects a fault, the FAULT circuit OPENS and fault records in the fault file. The user-provided controller should detect the OPEN circuit.

Should a FAULT occur, the user should shut down to troubleshoot the failure. Removing 120 VDC power shuts down the ACT2000. Toggling the RESET command will clear the FAULT alarm, but it does NOT clear the fault file.

The following faults are recorded:

Driver over-current

The maximum MCE current output limit is 25 amps. If the MCE is outputting its maximum current for ten (10) seconds, the MCE signals a FAULT.

Should MCE maximum current drop below the maximum current, the FAULT signal is cleared.

Tracking error

The ACT2000 position should continuously track demand. Should the position versus demand vary more than one motor revolution (0.20 inches) for more than ten (10) seconds, the MCE signals a FAULT.

Should the position return to within one motor revolution, the FAULT signal is cleared.

Watchdog expired

The MCE watchdog timer continuously monitors the firmware program. Should the MCE firmware program stop functioning, or attempt to access an illegal address, the MCE signals a FAULT.

This FAULT does not clear without RESET command.

Resolver to Digital Converter (RDC) failure

The MCE contains a resolver to digital converter chip (RDC) that provides position feedback information to the DSP. The RDC chip has on-board health monitoring.

Should the RDC detect an internal tracking error, a signal is sent to the MCE. Upon receipt, the MCE signals a FAULT.

This FAULT does not clear without RESET command.

Unregulated Voltage Low

The MCE signals a FAULT if the reference voltage drops below minimum for ten (10) seconds.

Should the voltage return to acceptable level, the FAULT signal is cleared.

+/- 14V High/Low

The MCE signals a FAULT if the internal ± 14 VDC power supplies exceed operating limits. This FAULT does not clear without RESET command.

Input voltage High/Low

The MCE signals a FAULT if the 120 VDC supply exceeds 180 VDC or drops below 75 VDC for more than 10 seconds. This FAULT clears when the 120 VDC supply voltage returns.

2.6 OVERTEMP Alarm

The OVERTEMP alarm is a discrete output from the ACT2000. The OVERTEMP circuit is CLOSED in the normal operating condition.

During normal operation, the ACT2000 monitors the electronics and motor winding temperatures. If ACT2000 detects the motor or electronics temperature above the maximum allowable, the OVERTEMP circuit is opened. The user-provided controller should detect the open circuit.

An OVERTEMP Alarm will be indicated if the motor winding temperature is 130°C or higher for ten (10) seconds or the electronics temperature is 110°C or higher for ten (10) seconds.

Should an OVERTEMP alarm occur, the user should shut down the actuator. Removing 120 VDC power shuts down the ACT2000. Toggling the RESET command will clear the FAULT alarm, but it does NOT clear the fault file.

 **Note:** The ACT2000 outputs an OVERTEMP alarm 5°C before the shut down threshold.

2.7 Automatic Shutdown

The ACT2000 has a self-protective shutdown feature.

- If any two motor winding temperatures exceed 135 °C for one (1) minute, the ACT2000 will shut down.
- If the electronics temperature exceeds 115 °C for one (1) minute, the ACT2000 will shut down.

 **Note:** Actuator position feedback and motor current will be set to 0 mA when the actuator shuts down.



WARNING:

Property Damage and Injury Hazard – If the motor windings exceed 135° C or the electronics exceed 115° C, the MCE will shut down power to the motor and electronics thereby allowing the actuator to move with load. Touching actuator may result in serious burn injury

2.8 ACT2000 Set-Up Parameters

The ACT2000 employs several variables to define its functionality. These variables are called set-up parameters. These parameters are downloaded through the RS232 interface to the ACT2000 using ActWiz software. See ActWiz Software Manual for further details.

The user can define set up any of the following parameters:

Home (Extend or Retract)

This parameter controls the direction the ACT2000 will move, extend or retract, to find the mechanical stop (HOME).

Span

This parameter sets the maximum stroke length. The span is measured from the HOME position.

Stop Position

This parameter sets the signal loss position. The signal loss position is measured from the HOME position.

Maximum Velocity

This parameter sets the maximum velocity.

Maximum Force

This parameter sets the maximum force output.

Maximum Homing Velocity

This parameter sets the maximum velocity used to find the HOME position.

Maximum Homing Force

This parameter sets the maximum force the ACT2000 will use to find the HOME position.

Maximum Holding Force

This parameter sets the maximum force at the HOME position while the position demand is $< 4.1\text{mA}$.

Table 2-1 lists the set-up parameters and factory default settings.

Parameter	Factory Setting
Part Number	Per Drawing
Actuator Type	Stand Alone
Command Source	Analog
Home	Retract
Span	5.9 inches
Stop Position	0.1 inches
Interpolation Table	Linear
Position Loop Constant	20
Current Loop PID Constants	
Proportional	2.0
Integral	200
Derivative	0
Velocity Loop PID Constants	
Proportional	40
Integral	10,000
Derivative	0
Maximum Velocity	6 in/s
Maximum Force	1000 lbf
Maximum Homing Velocity	0.5 in/s
Maximum Homing Force	500 lbf
Maximum Holding Force	500 lbf

Table 2-1 Typical ACT2000 Setup Parameters

3 INSTALLATION

The purpose of this section is to aid personnel in the installation, placement, and environmental considerations to be observed for the ACT2000 and associated equipment.

3.1 Inspection

The ACT2000 should be inspected immediately after unpacking. Check for damage, paying particular attention to the external lead wires.

-  **Note:** Retain the actuator’s original shipping container. In the event of future transportation requirements, this container will minimize damage during shipment.

3.2 Environmental Considerations

The ACT2000 will operate satisfactorily with ambient air temperature of -40 °C (-40 °F) to +93 °C (+200 °F). The ACT2000 is designed as an explosion-proof assembly. The ACT2000 enclosure is Canadian Standards Association (CSA) Type 3.



WARNING: Property Damage – Solvent/water may enter the electronics area during a high-pressure wash.

3.3 Mechanical Installation

This section describes proper ACT2000 installation. Care should be exercised to ensure compliance with the factory recommendations.

3.3.1 Space Requirements

Figure 3-1 shows external dimensions and mounting provisions for the ACT2000-590P. Figure 3-2 shows the external dimensions and mounting provisions for the ACT2000-200F. The user should ensure additional swing clearance as required.

3.3.2 Mounting Considerations

The ACT2000 can be directly mounted to a gas turbine engine using brackets provided by the engine manufacturer. The ACT2000 can be mounted in any orientation (UP, DOWN, SIDEWAYS).

The ACT2000 may provide a clevis, or other method, for installing the motor end. High strength bolts (0.375 diameter) are recommended to secure the actuator to a user-provided mount bracket.



WARNING:
Lifting Hazard – Do not attempt to hand lift actuator. Use appropriate lifting equipment.

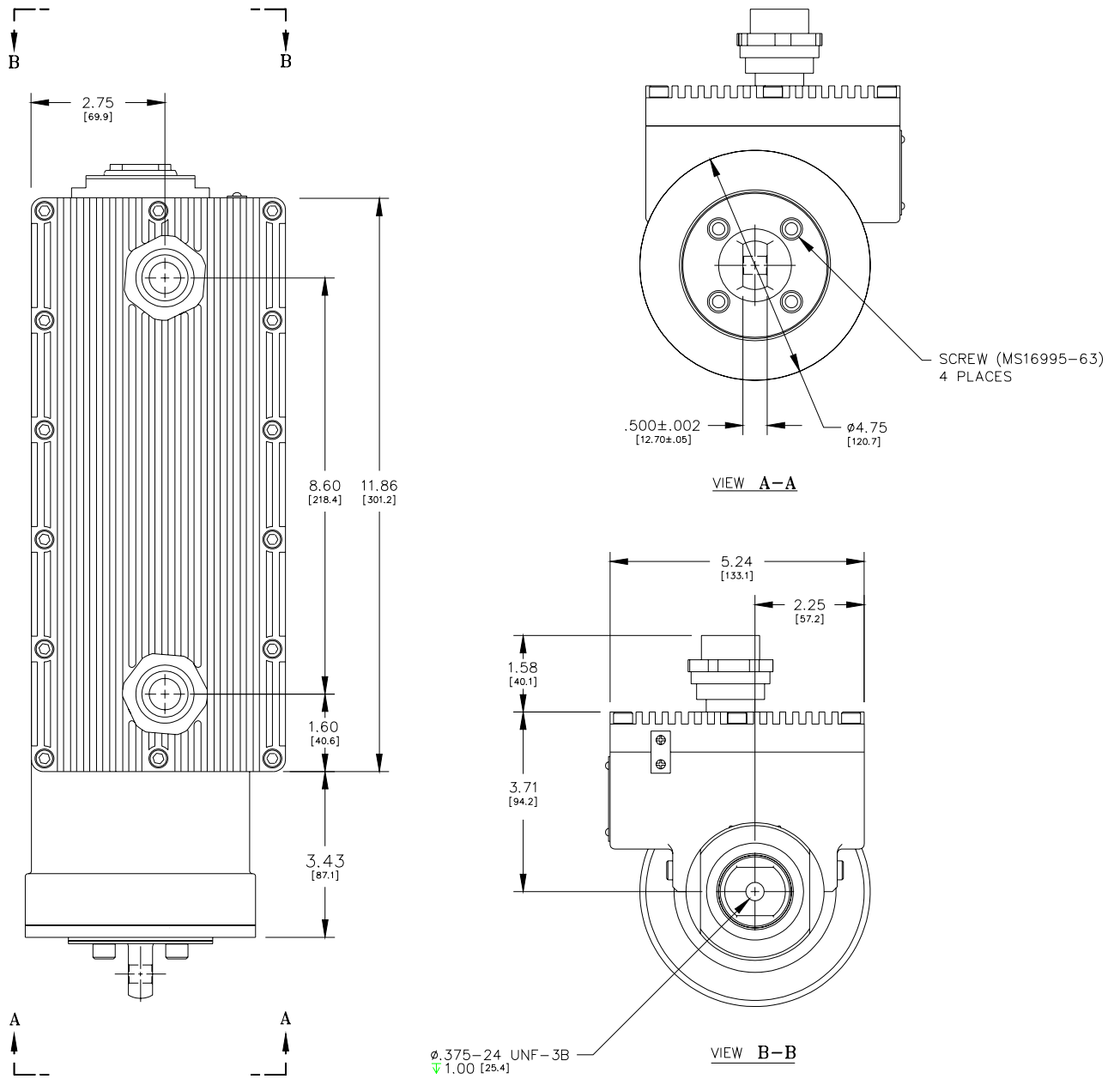

Figure 3-1: ACT2000-590P Envelope

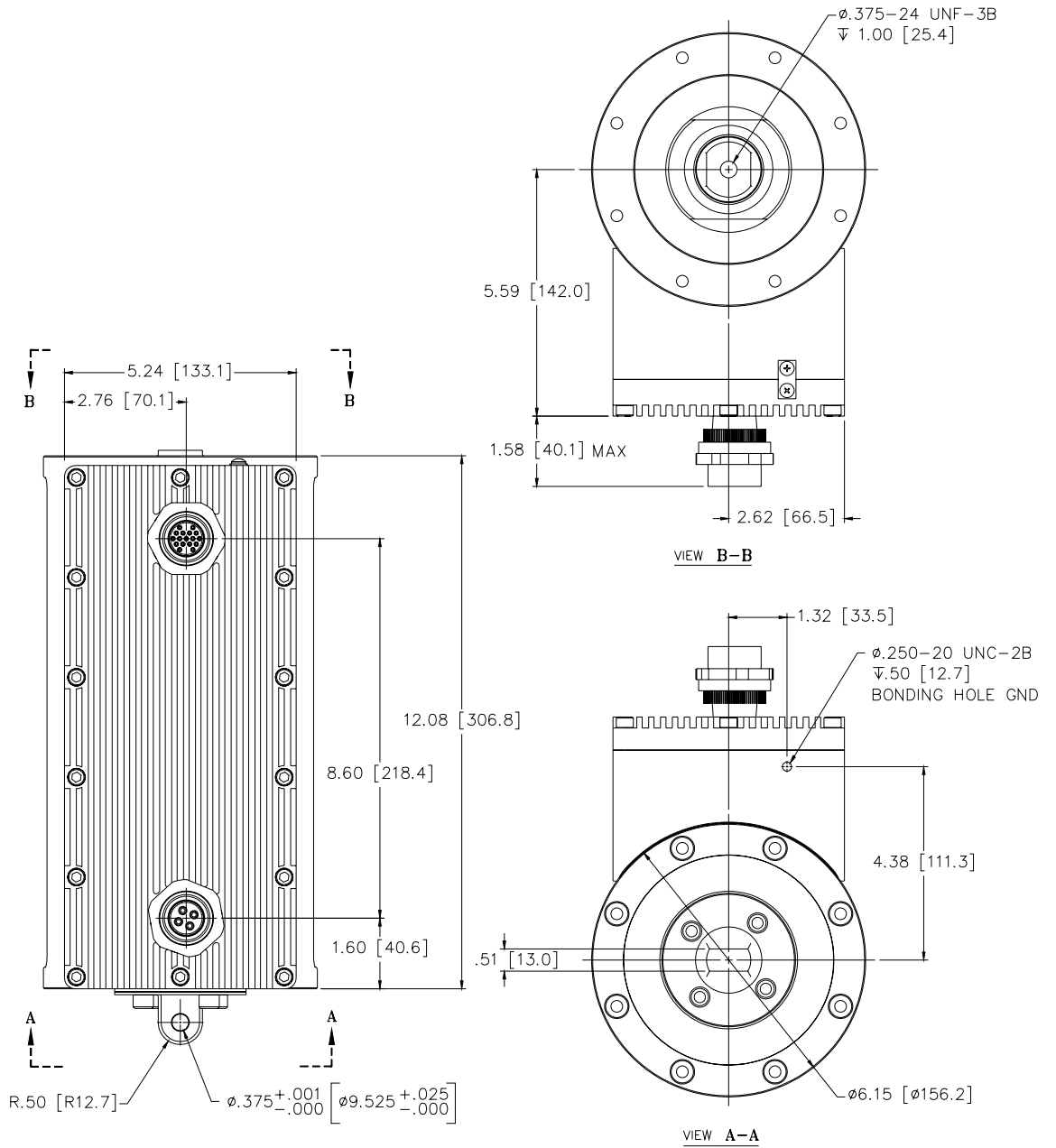



Figure 3-2: ACT2000-200F Envelope

-  **Note:** The clevis can be rotated to any orientation to support installation. To rotate, loosen the four retaining screws and rotate to desired angle. Screw pattern can be indexed ± 45 degrees to provide additional adjustment. Torque the four retaining screws to 117-138 in-lbs.

**WARNING:**

Explosion Hazard – Do not remove the clevis. Removing the clevis violates the warranty.

The extension rod has a 0.375-24 UNF-3B female thread for user-provided hardware. The user may provide a standard 0.375-24-3B rod end (recommended) or other appropriate mounting hardware. The extension rod has wrench flats to counteract mounting hardware installation torque.

**WARNING:**

Property Damage Hazard – Always use the extension rod wrench flats when installing mounting hardware. Failure to use the wrench flats may damage or break the internal anti-rotation guide.

3.3.3 Extension Rod Movement

With 120 VDC power removed, the ACT2000 extension rod is free to move. Approximately 60 to 100 lbf is required to extend or retract the extension rod. A rod guide is provided internally to prevent extension rod rotation.

**WARNING:**

Property Damage Hazard – Do not attempt to rotate the extension rod. This may damage the internal anti-rotation guide and void the warranty.

3.4 Electrical Installation

The ACT2000 is suitable for use in hazardous locations. See nameplate for certifications. Care should be taken to ensure compliance with the factory recommendations. Wiring must be in accordance with local authorities jurisdiction.

3.4.1 Wiring Specifications and Requirements

This section describes the recommended power and control harness wiring to the ACT2000. Please consult the factory if there are any questions. See Table 3-5 for DC power supply requirements.



WARNING:

94/9/EC (ATEX) Compliance – Special Conditions for Safe Use:

Two special factory-sealed unions are mounted on the equipment to ensure the electrical connection to the network and to provide the feedback signal to the user.

The installation of these devices and the final connections to the conduit shall comply with the requirements of the European standards.

Power Harness Recommended Wiring

Under normal operation and load, the ACT2000 requires less than one (1) amp input current.

Under transient operation (under load) the ACT2000 may require up to (20) amps of current.

The recommended wiring is a two-conductor shielded cable containing twisted-pair wires with individual shields. Use a wire size large enough to accommodate the installation and provide a maximum one (1) ohm loop resistance. See Table 3-1 (below) for recommended wire sizes.

Distance to User Power	Wire Size (Minimum)
Up to 500 ft	AWG 10 stranded
Over 500 ft	Consult Factory

Table 3-1: Power Harness Recommended Wire Size



WARNING:

Shock Hazard – Both the 120 VDC power and auxiliary wires should be connected. If only the primary power wires are connected, the 120 VDC auxiliary power wires are electrically “hot” and must be insulated on the ends.

Note: Use a separate conduit for the power wiring. This will prevent noise pickup and transmission from ancillary equipment, which could cause instability in the actuator.

Signal Harness Recommended Wiring

The signal harness contains both analog and digital inputs and outputs. The analog inputs and outputs are 4mA to 20mA and are electrically isolated up to 500 VAC from the enclosure, 120VDC power, digital I/O, and serial interface. The analog interfaces are not isolated from each other.

 **Note:** For proper operation of the actuator, the voltage between the control inputs and the negative terminal of the power supply should be below 200 VDC.

The discrete inputs and outputs are 24 VDC and are electrically isolated up to 500 VAC.

The recommended wiring is a fourteen-conductor shielded cable containing twisted-pair wires with individual shields. Use a wire size large enough to accommodate the installation and provide a maximum fifty (50) ohm loop resistance. See Table 3-2 for recommended wire sizes.

Distance to User Controller	Wire Size (Minimum)
Up to 1000 ft	AWG 18 stranded
Over 1000 ft	Consult Factory

Table 3-2: Digital Harness Recommended Wire Size

 **Note:** Use a separate conduit for the signal wiring. This will prevent noise pickup and transmission from ancillary equipment, which could cause instability in the actuator.

Shielded Wiring

All shielded cable must be a twisted conductor pair with either a foil or braided shield. All signal lines should be shielded to prevent picking up stray signals. Connect shields per Figure 3-3 (page 3-8). Wire exposed beyond the shield should be as short as possible.



WARNING:

Property Damage Hazard – This actuator is 89/339/EEC EMC Directive compliant (CE mark) using watertight, flexible conduit (plastic over steel) and Belden 8719 shielded, twisted pair audio, broadcast and instrumentation cable. Use of other conduit or wire invalidates EMC Directive compliance.

Property Damage Hazard – Do Not connect 24VDC power without current limiting (25 mA) across digital or analog outputs.

Serial Wiring

The serial inputs are not electrically isolated. Isolation must be provided when connecting to a computer.



WARNING:

Property Damage Hazard – Serial inputs are not electrically isolated. Failure to properly isolate the user serial interface could result in actuator or computer damage. Use separate conduits for power and signal wiring. Close proximity to power lines may cause signal interference.

Shock Hazard – The serial inputs are not electrically isolated. If the 120 VDC power input is floating (not grounded), the serial input connections may have up to 120 VDC present.

Property Damage Hazard – DO NOT connect 24VDC power to any of the serial interface connections.



Note: Serial connection limited to 50 ft for local interface only with laptop PC.

3.4.2 Wire Lists

This section will provide ACT2000 wire hook-up information.

Power Harness Electrical Hook-Up

Table 3-3 shows the factory wiring for the ACT2000 power harness.

Wire Color	Function	AWG
RED	Power	14
WHITE/RED	Power (AUX)	14
GREEN	Power Return	14
WHITE/GREEN	Power Return (AUX)	14

Table 3-3: ACT2000 Power Harness Wire List

Power Harness Electrical Hook-Up

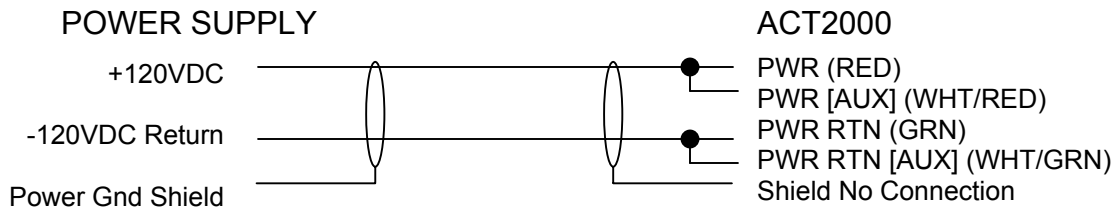

Digital Harness Electrical Hook-Up

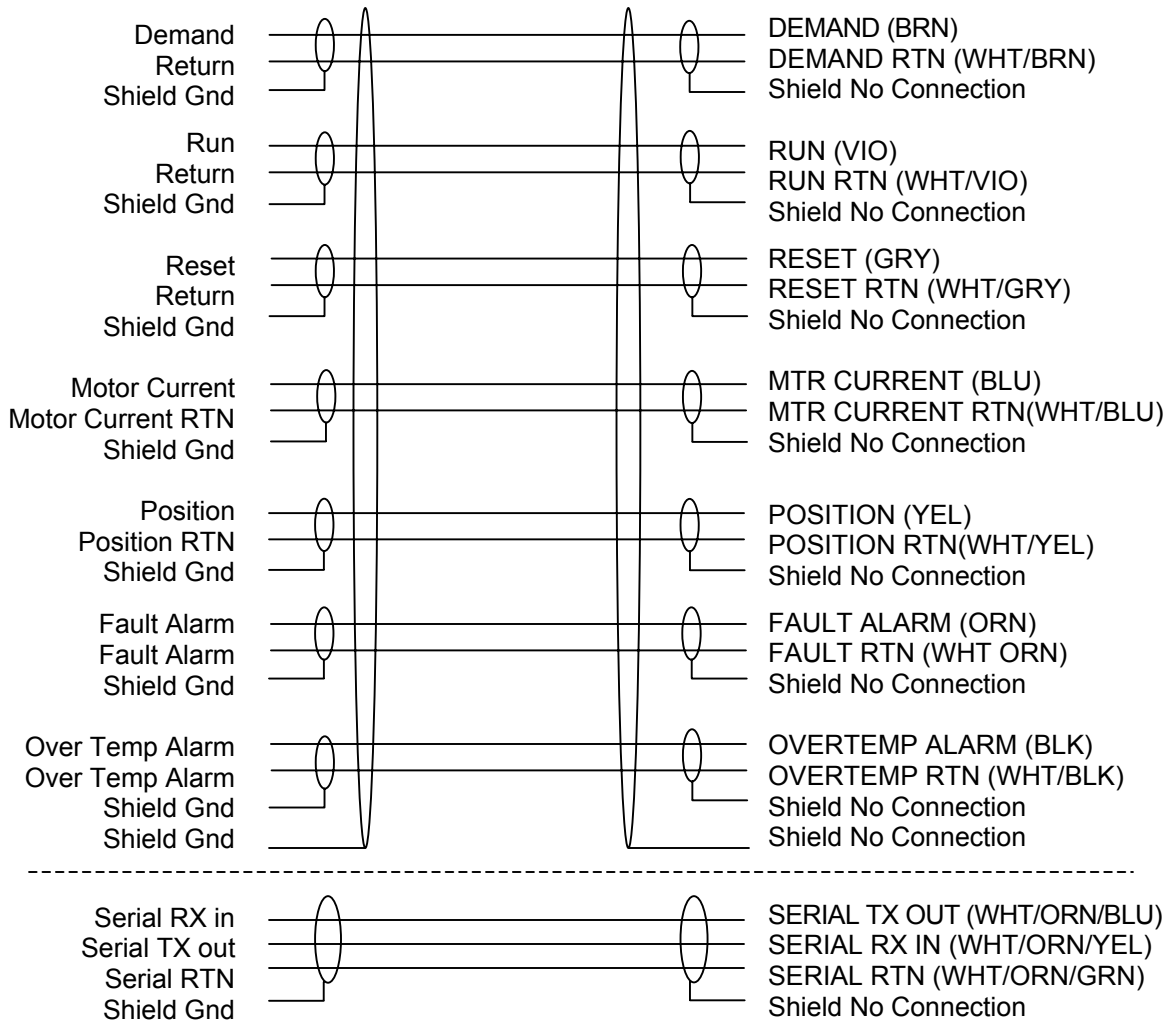

ENGINE CONTROLLER

ACT2000

Figure 3-3: ACT2000 Wiring Diagram

Table 3-4 shows the factory wiring and reference signals for the ACT2000 signal harness.

 **Note:** The serial wiring is segregated from the other wires.

Wire Color	Function	AWG	Signals
WHITE/ORANGE/YELLOW	Serial/RX In	20	± 12 V
WHITE/ORANGE/BLUE	Serial/TX Out	20	± 12 V
WHITE/ORANGE/GREEN	Serial Return	20	0 V
BLACK	OVER TEMP Alarm	20	0 / 24 V
WHITE/BLACK	OVER TEMP Alarm Return	20	0 V
ORANGE	FAULT Alarm	20	0 / 24 V
WHITE/ORANGE	FAULT Alarm Return	20	0 V
VIOLET	RUN Command	20	0 / 24 V
WHITE/VIOLET	RUN Command Return	20	0 V
GRAY	RESET Command	20	0 / 24 V
WHITE/GRAY	RESET Command Return	20	0 V
BROWN	Position Demand	20	4 – 20mA
WHITE/BROWN	Position Demand Return	20	0 V
YELLOW	Position Feedback	20	4 – 20mA
WHITE/YELLOW	Position Feedback RTN	20	0 V
BLUE	Motor Current	20	4 – 20mA
WHITE/BLUE	Motor Current RTN	20	0 V

 **Note:** The serial Return is connected to the 120 V input return.

Table 3-4: ACT2000 Digital Harness Wire List

Power Supply Requirements

A battery power system is recommended, Table 3-5 lists the power supply requirements.

Voltage:	120VDC nominal 80VDC minimum 160VDC maximum
Max Ripple:	4 VAC RMS or 12VAC p-p
Max Current:	20 AMPS
Typical Continuous Current:	<1 AMP
Typical Transient Current:	+20 A <60ms +10A <600 ms -5A <100 ms
*Output Capacitance:	50,000 uF

**The output capacitance applies for non-battery power systems and assumes full stroke step changes in actuator position at rated load.*

Table 3-5 Power Supply Requirements

4 TROUBLESHOOTING

The information contained in this section is intended to aid maintenance technicians in troubleshooting and isolating causes of malfunctions in the ACT2000. Most electrical fault isolation of the actuator can be accomplished by using an external oscilloscope and digital voltmeter (DVM).

The ACT2000 is comprised of highly reliable components and should not develop service problems under normal operating conditions. However, over a period of time and service, failures may develop. Personnel responsible for fault analysis should be thoroughly acquainted with physical and electrical configurations, Theory of Operation (Section 2), and Installation (Section 3).

Resolve problems noted during operation or maintenance as soon as possible. The causes of many problems can be traced through the information contained in the block diagrams shown in Section 2.



WARNING:
Property Damage Hazard – Continuing to operate the actuator in a malfunctioning condition is hazardous to personnel and can cause property damage.

Table 4-1 lists some common failures that can occur upon initial actuator installation. Table 4-2 lists some common failures that can occur after initial installation.

In addition, the ACT2000 has some on-board troubleshooting capability. The ActWiz software has a fault file that can be uploaded to pinpoint a failure cause. See ActWiz Software Manual for more details.

If, after following the troubleshooting procedures, the user is unable to find the cause of the problem and repair it, contact the factory for assistance. See Section 8 for return information.

Table 4-1 ACT2000 Initial Installation Troubleshooting Chart

Symptom	Probable Causes	Corrective Action
Actuator Inoperative - FAULT alarm	Power Wires not connected No or low 120 VDC power	Ensure RED and GREEN wires correctly connected to Actuator Ensure 120 VDC Primary System Power at Actuator
Actuator Inoperative - NO FAULT alarm	No RUN or position command	Ensure VIOLET and WHITE/VIOLET wires correctly connected to Actuator Ensure 24 VDC RUN and position command at Actuator
Actuator moves toward HOME then stops	Intermittent RUN command Homing Force Too Low No position demand	Ensure consistent 24 VDC RUN and position command Ensure position command at actuator
Actuator moves toward HOME intermittently	Intermittent RESET command	Ensure GRAY and WHITE/GRAY wires correctly connected to Actuator Ensure consistent 24 VDC RESET command
Actuator finds HOME then moves to STOP position	No position demand signal	Ensure BROWN and WHITE/BROWN wires correctly connected to Actuator Ensure position demand > 2.0 mA at Actuator
Actuator does not track position demand	No position demand signal	Ensure BROWN and WHITE/BROWN wires correctly connected to Actuator Ensure position demand > 4.1 mA at Actuator
Actuator does not hold consistent position-oscillates or dithers	Varying position demand signal	Ensure stable position demand at the actuator
No position feedback	Position feedback wires not connected No or low 120 VDC power Actuator auto shut down	Ensure YELLOW and WHITE/YELLOW wires correctly connected Ensure 120VDC at Actuator Upload Fault File- check for electronics or motor windings over temperature faults. Check for jammed extension rod
No motor current feedback	Motor current wires not connected No or low 120 VDC power	Ensure BLUE and WHITE/BLUE wires correctly connected
Actuator Operative- FAULT alarm active	Open circuit Internal FAULT	Ensure ORANGE and WHITE/ORANGE wires correctly connected to Actuator Upload Fault File to identify source of fault
Actuator Operative- OVER TEMP alarm active	Open circuit Electronics or Motor winding temperature out of range	Ensure BLACK and WHITE/BLACK wires correctly connected to Actuator Reduce External ambient temperature Check for jammed extension rod
RS232 Interface Inoperative	Incorrect wiring No or low 120 VDC power COM1 not connected	Ensure WHITE/ORANGE/YELLOW, WHITE/ORANGE/BLUE, WHITE/ORANGE/GREEN wires correctly connected to Actuator and laptop PC. Ensure 120 VDC Primary System Power at Actuator Check laptop/PC com port

Table 4-2 ACT2000 In-Service Troubleshooting Chart

Symptom	Probable Causes	Corrective Action
FAULT alarm	Various	Upload Fault File to identify source of fault
OVER TEMP alarm	Ambient temperature limit exceeded Electronics or Motor winding temperature out of range	Allow actuator to cool and re-start Reduce ambient temperature Check for jammed extension rod
FAULT and OVERTEMP alarm	No 120VDC Power DSP Failure	Ensure 120 VDC at actuator Contact factory

For troubleshooting purposes use Table 4-3 to verify the actuator electrical continuity integrity.

Disconnect the actuator power and digital harness connectors and use a digital multimeter (DMM) to check the resistance values between the wires indicated on the table. If an open circuit is detected, send actuator to Precision Engine Controls Corporation for test and repair.



WARNING:

Shock Hazard – Remove all power to actuator prior to continuity check

Table 4-3 ACT2000 Electrical Hook-Up Continuity Troubleshooting Chart

Function	Actuator Wire Colors	Resistance Value
DEMAND	BRN and WHT/BRN	225Ω
RUN	VIO and WHT/VIO	4.7KΩ
RESET	GRY and WHT/GRY	4.7KΩ
POWER	RED and WHT/RED	High Impedance, but not open circuit.
MOTOR CURRENT	BLU and WHT/BLU	High Impedance
POSITION	YEL and WHT/YEL	High Impedance
FAULT ALARM	ORN and WHT/ORN	High Impedance
OVERTEMP	BLK and WHT/BLK	High Impedance



INTENTIONALLY BLANK

5 DECOMMISSIONING AND DISPOSAL

This section contains recommended ACT2000 decommissioning and disposal practices. It is for permanent removal or replacement of the installed product, with no intentions of rework, overhaul, or to be used as spares.

For removal follow proper lockout /tagout procedures and verify no live electrical circuits:

1. Disconnect power harness to ACT2000.
2. Disconnect signal harness to ACT2000



Note: Follow local environmental codes in regards to disposal of electronic components, specifically all electrolytic capacitors.



INTENTIONALLY BLANK

6 ACT2000 GENERAL SPECIFICATIONS

Power Input	Nominal Voltage: 120 VDC Minimum Voltage: 80 VDC Maximum Voltage: 160 VDC Maximum Current: 20A Typical Transient Current: +20A < 60ms; +10A < 600ms; -5A < 100ms Typical Continuous Current: < 1A
RUN and RESET Command Input	ON Voltage: 12 to 32 VDC; +24 VDC Nominal ON Current: 6.5 mA Nominal @ 24 VDC OFF Voltage: 3.5 VDC Maximum OFF Current: 0.75 mA Maximum
FAULT and OVERTEMP Output	OFF Voltage: 32 VDC Maximum OFF Leakage Current: 150 µA Maximum ON Current: 25 mA Maximum ON Voltage Drop: 1.5 VDC Maximum @ 25 mA
Analog Command Input	Current: 4 to 20 mA; 25 mA Maximum Voltage: 5 VDC Maximum Internal Impedance: 200 Ω
Position and Motor Current Feedback Analog	Current: 4 to 20 mA External Load Resistance: 500 Ω Maximum
Maximum Common Mode Voltage	±200 VDC User I/O to 120 VDC Return (less serial interface)
Temperature Limits	Operating Ambient: -40° C (-40° F) to +93° C (+200° F) Operating Fuel: -40° C (-40° F) to +125° C (+257° F) Storage: -40° C (-40° F) to +125° C (+257° F)
Maximum Velocity	10 in/sec
Maximum Continuous Force	500 lbf (100% Duty Cycle)
Maximum Peak Force	1000 lbf (100% Duty Cycle)
Maximum Stroke	5.9 in (Configuration Dependent)
Accuracy	± 1% Full Stroke
Environmental Rating	CSA Type 3, European IP65
EMC	EN 50081-2 and EN50082-2 for DC powered industrial equipment
Vibration	Mil-Std-810E, Category 4 (5 – 2000 Hz)
Mean Time Before Unscheduled Removal	30,000 Hours
Life Cycles	32,000 Minimum
Electrical Connection	Power Harness: (4) AWG 14, 90 in, ¾ NPT Conduit (EP) Digital Harness: (17) AWG 20, 90 in, ¾ NPT Conduit (EP)
North American Certifications	CSA Class I, Div 1, Group B, C, D; T4
European Directive Compliance (CE Mark)	EEx d, IIB+H ₂ ; T4 94/9/EC Potentially Explosive Atmospheres (ATEX) 98/37/EC Machinery Directive 89/336/EEC Electromagnetic Compatibility Directive (EMC)
Materials	
Housings	6061-T6 Anodized Aluminum
Conduit Union	Zinc Plated Steel
Extension Rod	17-4 PH CRES
Clevis	17-4 PH CRES
Rod End Bearing	Aluminum Bronze
Seals	Nitrile, RTV and Teflon
Dimensions	6.0 in x 16.0 in
Approx. Dry Weight	Pin Mounted 35 lbs. Max Flange Mounted 50 lbs. Max

P-PRECISION
INTENTIONALLY BLANK

7 GLOSSARY

Term	Definition
RUN Command	A discrete 24 VDC signal that enables the ACT2000 extension rod to move.
RESET Command	A discrete 24 VDC signal that causes the ACT2000 internal program (firmware) to jump to the beginning.
Controller	A user-provided computer that executes commands to the ACT2000 and accepts analog and discrete feedback.
Position Demand	A 4mA to 20mA signal that commands the ACT2000 to move to a certain position. The signal is scaled with SPAN.
Position Demand Feedback	A 4mA to 20mA signal that communicates the actual ACT2000 position to the controller.
Motor Current Feedback	A 4mA to 20mA signal that is proportional to the ACT2000 motor current. The signal is scaled with Max. Force.
FAULT alarm	A discrete signal from the ACT2000 that communicates an internal failure. The controller will see an open circuit when a FAULT alarm is active.
OVERTEMP alarm	A discrete signal from the ACT2000 that communicates an internal over temperature; electronics or motor. The controller will see an open circuit when OVERTEMP alarm is active.
HOME	A mechanical rigid stop at which the ACT2000 calculates position from. HOME is found at start-up during Homing sequence. The ACT2000 defines HOME when the motor current exceeds the HOMING FORCE and velocity is zero. HOME is defined as 4mA position demand.
Homing sequence	When the ACT2000 extends or retracts to find a rigid mechanical stop.
SPAN	Maximum distance from HOME. SPAN is defined as 20mA position demand.
STOP position	A user-defined position between HOME and SPAN that the ACT2000 travels to upon loss of RUN or position demand signal.
Maximum Velocity	A user defined maximum velocity in inches per second.
Maximum Homing Force	A user defined maximum homing force output setting. The motor control electronics uses this setting to determine the maximum motor current in the Homing sequence.
Maximum Holding Force	A user defined maximum force while in the Holding Motor Current state.

P-PRECISION

INTENTIONALLY BLANK

Free Manuals Download Website

<http://myh66.com>

<http://usermanuals.us>

<http://www.somanuals.com>

<http://www.4manuals.cc>

<http://www.manual-lib.com>

<http://www.404manual.com>

<http://www.luxmanual.com>

<http://aubethermostatmanual.com>

Golf course search by state

<http://golfingnear.com>

Email search by domain

<http://emailbydomain.com>

Auto manuals search

<http://auto.somanuals.com>

TV manuals search

<http://tv.somanuals.com>