

CENTRAL PNEUMATIC®

AIR MICRO DIE GRINDER

Model 97870

SET UP AND OPERATING INSTRUCTIONS



Diagrams within this manual may not be drawn proportionally.

Due to continuing improvements, actual product may differ slightly from the product described herein.

Distributed exclusively by Harbor Freight Tools®.

3491 Mission Oaks Blvd., Camarillo, CA 93011

Visit our website at: <http://www.harborfreight.com>



**Read this material before using this product.
Failure to do so can result in serious injury.
SAVE THIS MANUAL.**

Copyright© 2008 by Harbor Freight Tools®. All rights reserved. No portion of this manual or any artwork contained herein may be reproduced in any shape or form without the express written consent of Harbor Freight Tools.

For technical questions or replacement parts, please call 1-800-444-3353.

Manual Revised 11h

CONTENTS		TROUBLESHOOTING..... 13
SAFETY ALERT SYMBOL AND SIGNAL WORDS	3	ACCESSORY LIST 14
IMPORTANT SAFETY INSTRUCTIONS	3	PARTS LIST..... 15
GENERAL.....	3	ASSEMBLY DIAGRAM..... 15
WORK AREA.....	3	LIMITED 90 DAY WARRANTY 16
PERSONAL SAFETY	4	
TOOL USE AND CARE	5	
SERVICE	5	
AIR SOURCE.....	5	
SYMBOLS AND SPECIFIC SAFETY INSTRUCTIONS	6	
SYMBOL DEFINITIONS	6	
SPECIFIC SAFETY INSTRUCTIONS	6	
VIBRATION PRECAUTIONS	7	
FUNCTIONAL DESCRIPTION.....	8	
SPECIFICATIONS	8	
COMPONENTS AND CONTROLS	8	
INITIAL TOOL SET UP/ ASSEMBLY.....	8	
UNPACKING.....	8	
AIR SUPPLY.....	8	
OPERATING INSTRUCTIONS	10	
TOOL SET UP	10	
WORK PIECE AND WORK AREA SET UP	10	
GENERAL OPERATING INSTRUCTIONS	10	
USER-MAINTENANCE INSTRUCTIONS	12	
CLEANING, MAINTENANCE, AND LUBRICATION ???	12	
LUBRICATION DIAGRAM	12	

SAVE THIS MANUAL

Keep this manual for the safety warnings and precautions, assembly, operating, inspection, maintenance and cleaning procedures. Write the product's serial number in the back of the manual near the assembly diagram (or month and year of purchase if product has no number). Keep this manual and the receipt in a safe and dry place for future reference.

Safety Alert Symbol and Signal Words

In this manual, on the labeling, and all other information provided with this product:



This is the safety alert symbol. It is used to alert you to potential personal injury hazards. Obey all safety messages that follow this symbol to avoid possible injury or death.

DANGER

DANGER indicates a hazardous situation which, if not avoided, will result in death or serious injury.

WARNING

WARNING indicates a hazardous situation which, if not avoided, could result in death or serious injury.

CAUTION

CAUTION, used with the safety alert symbol, indicates a hazardous situation which, if not avoided, could result in minor or moderate injury.

NOTICE

NOTICE is used to address practices not related to personal injury.

CAUTION

CAUTION, without the safety alert symbol, is used to address practices not related to personal injury.

IMPORTANT SAFETY INSTRUCTIONS

INSTRUCTIONS PERTAINING TO A RISK OF FIRE, ELECTRIC SHOCK, OR INJURY TO PERSONS

WARNING – When using tools, basic precautions should always be followed, including the following:

General

- a. To reduce the risks of electric shock, fire, and injury to persons, read all the instructions before using the tool.

Work area



- a. Keep the work area clean and well lighted. Cluttered benches and dark areas increase the risks of electric shock, fire, and injury to persons.
- b. Do not operate the tool in explosive atmospheres, such as in the presence of flammable liquids, gases, or dust. The tool is able to create sparks resulting in the ignition of the dust or fumes.
- c. *Keep bystanders, children, and visitors away while operating the*

tool. Distractions are able to result in the loss of control of the tool.

Personal safety

- a. **Stay alert. Watch what you are doing and use common sense when operating the tool. Do not use the tool while tired or under the influence of drugs, alcohol, or medication.** A moment of inattention while operating the tool increases the risk of injury to persons.
- b. **Dress properly. Do not wear loose clothing or jewelry. Contain long hair. Keep hair, clothing, and gloves away from moving parts.** Loose clothes, jewelry, or long hair increases the risk of injury to persons as a result of being caught in moving parts.
- c. **Avoid unintentional starting. Be sure the switch is off before connecting to the air supply.** Do not carry the tool with your finger on the valve or connect the tool to the air supply with the valve on.
- d. **Remove adjusting keys and wrenches before turning the tool on.** A wrench or a key that is left attached to a rotating part of the tool increases the risk of personal injury.
- e. **Do not overreach. Keep proper footing and balance at all times.** Proper footing and balance enables better control of the tool in unexpected situations.
- f.  **Use safety equipment.** A dust mask, non-skid safety shoes and a hard hat must be used for the applicable

conditions. Wear heavy-duty work gloves during use.

- g.  **Always wear eye protection.** Wear ANSI-approved safety goggles.
- h.  **Always wear hearing protection when using the tool.** Prolonged exposure to high intensity noise is able to cause hearing loss.
- i. Keep this product and all other tools away from children and animals. Do not allow spectators in or around the work area.
- j. Never submerge this tool in liquids or use while in an excessively moist, or volatile environment.
- k. Ensure the bit, Collet Nut and work piece are tightly secured before each use.
- l. Use only included and/or recommended parts & accessories with this tool. Never use a carbide tipped or steel circular saw blade with this Die Grinder. Do not use a wood carving blade, carving disc with chain saw cutters, or a cutting carving disc with this Die Grinder.
- m. Never exceed the maximum rated air pressure for this tool. Also never attempt to use a propellant other than what has been recommended/specified.
- n. **Use for intended purposes only.** Never force or modify a tool to perform a task for which it was not constructed.

Tool use and care

- a. **Use clamps or another practical way to secure and support the workpiece to a stable platform.** Holding the work by hand or against the body is unstable and is able to lead to loss of control.
- b. **Do not force the tool.** Use the correct tool for the application. The correct tool will do the job better and safer at the rate for which the tool is designed.
- c. **Do not use the tool if the valve does not turn the tool on or off.** Any tool that cannot be controlled with the switch is dangerous and must be repaired.
- d. **Disconnect the tool from the air source before making any adjustments, changing accessories, or storing the tool.** Such preventive safety measures reduce the risk of starting the tool unintentionally. Turn off and detach the air supply, safely discharge any residual air pressure, and release the throttle and/or turn the switch to its off position before leaving the work area.
- e. **Store the tool, when it is idle, out of reach of children and other untrained persons.** A tool is dangerous in the hands of untrained users.
- f. **Maintain the tool with care.** Keep a cutting tool sharp and clean. A properly maintained tool, with sharp cutting edges reduces the risk of binding and is easier to control.
- g. **Check for misalignment or binding of moving parts, breakage of parts, and any other condition that**

affects the tool's operation. If damaged, have the tool serviced before using. Many accidents are caused by poorly maintained tools. There is a risk of bursting if the tool is damaged.

- h. **Use only accessories that are identified by the manufacturer for the specific tool model.** Use of an accessory not intended for use with the specific tool model, increases the risk of injury to persons. Wheels and other accessories running over rated speed can fly apart and result in a risk of injury to persons.

Service

- a. **Tool service must be performed only by qualified repair personnel.**
- b. **When servicing a tool, use only identical replacement parts. Use only authorized parts.**
- c. **Use only the lubricants supplied with the tool or specified by the manufacturer.**

Air source

- a.  **Never connect to an air source that is capable of exceeding 90 psi.** Over pressurizing the tool may cause bursting, abnormal operation, breakage of the tool or serious injury to persons. Use only clean, dry, regulated compressed air at the rated pressure or within the rated pressure range as marked on the tool. Always verify prior to using the tool that the air source has been adjusted to the rated air pressure or within the rated air-pressure range.

- b. **Never use oxygen, carbon dioxide, combustible gases or any bottled gas as an air source for the tool.**

Such gases are capable of explosion and serious injury to persons.



SAVE THESE INSTRUCTIONS.

SYMBOLS AND SPECIFIC SAFETY INSTRUCTIONS

Symbol Definitions





Symbol	Property or statement
n_o	No-load speed
.../min	Revolutions or reciprocation per minute
PSI	Pounds per square inch of pressure
ft-lb	Foot-pounds of torque
BPM	Blows per minute
CFM	Cubic Feet per Minute flow
SCFM	Cubic Feet per Minute flow at standard conditions
NPT	National pipe thread, tapered
NPS	National pipe thread, straight
	WARNING marking concerning Risk of Eye Injury. Wear ANSI-approved eye protection.
	WARNING marking concerning Risk of Hearing Loss. Wear hearing protection.
	WARNING marking concerning Risk of Respiratory Injury. Wear NIOSH-approved dust mask/respirator.

Chart continued in next column.

Symbol Definitions

Symbol	Property or statement
	WARNING marking concerning Risk of Explosion.

Specific Safety Instructions

- The warnings and precautions discussed in this manual cannot cover all possible conditions and situations that may occur. It must be understood by the operator that common sense and caution are factors which cannot be built into this product, but must be supplied by the operator.

WARNING – Some dust created by power sanding, sawing, grinding, drilling, and other construction activities, contains chemicals known [to the State of California] to cause cancer, birth defects or other reproductive harm. Some examples of these chemicals are:

- Lead from lead-based paints
- Crystalline silica from bricks and cement or other masonry products
- Arsenic and chromium from chemically treated lumber

Your risk from these exposures varies, depending on how often you do this type of work. To reduce your exposure to these chemicals: work in a well ventilated area, and work with approved safety equipment, such as those dust masks that are specially designed to filter out microscopic particles. (California Health & Safety Code § 25249.5, *et seq.*)

WARNING – The brass components of this product contain lead, a chemical known to the State of California to cause birth defects (or other repro-

ductive harm). (California Health & Safety code § 25249.5, *et seq.*)

2. Only use with accessories rated to handle the forces exerted by this tool during operation. Accessories not designed for the forces generated may break and forcefully launch pieces.
3. Attach all accessories properly to the tool before connecting the air supply. A loose accessory may detach or break during operation.
4. Obey the manual for the air compressor used to power this tool.
5. Install an in-line shutoff valve to allow immediate control over the air supply in an emergency, even if a hose is ruptured.
6. Do not lay the tool down until it has come to a complete stop. Moving parts can grab the surface and pull the tool out of your control.

Vibration Precautions

This tool vibrates during use. Repeated or long-term exposure to vibration may cause temporary or permanent physical injury, particularly to the hands, arms and shoulders. To reduce the risk of vibration-related injury:

1. Anyone using vibrating tools regularly or for an extended period should first be examined by a doctor and then have regular medical check-ups to ensure medical problems are not being caused or worsened from use. Pregnant women or people who have impaired blood circulation to the hand, past hand injuries, nervous system disorders, diabetes, or Raynaud's Disease should not use

this tool. If you feel any medical or physical symptoms related to vibration (such as tingling, numbness, and white or blue fingers), seek medical advice as soon as possible.

2. Do not smoke during use. Nicotine reduces the blood supply to the hands and fingers, increasing the risk of vibration-related injury.
3. Wear suitable gloves to reduce the vibration effects on the user.
4. Use tools with the lowest vibration when there is a choice between different processes.
5. Include vibration-free periods each day of work.
6. Grip tool as lightly as possible (while still keeping safe control of it). Let the tool do the work.
7. To reduce vibration, maintain tool as explained in this manual. If abnormal vibration occurs, stop immediately.



**SAVE THESE
INSTRUCTIONS.**

FUNCTIONAL DESCRIPTION

Specifications

Exhaust Position	Frontal Exhaust
On/Off Method	Built-in Rotary Valve
Air Inlet	1/4" -18 NPT (male inlet coupler)
Maximum Speed*	25,000 RPM
Air Consumption	2 CFM @ 90 PSI
Collet Size	1/8"

* Maximum speed at stated maximum air pressure. Excess air pressure is hazardous and may cause the tool to exceed stated maximum speed.

INITIAL TOOL SET UP/ ASSEMBLY



Read the **ENTIRE IMPORTANT SAFETY INFORMATION** section at the beginning of this manual including all text under subheadings therein before set up or use of this product.

Note: For additional information regarding the parts listed in the following pages, refer to the Assembly Diagram near the end of this manual.

Unpacking

When unpacking, check to make sure that the item is intact and undamaged. If any parts are missing or broken, please call Harbor Freight Tools at the number shown throughout the manual as soon as possible.

- This air tool may be shipped with a protective plug covering the air inlet. Remove this plug before set up.

Air Supply

⚠ WARNING TO PREVENT EXPLOSION:



Use only clean, dry, regulated, compressed air to power this tool. Do not use oxygen, carbon dioxide, combustible gases, or any other bottled gas as a power source for this tool.

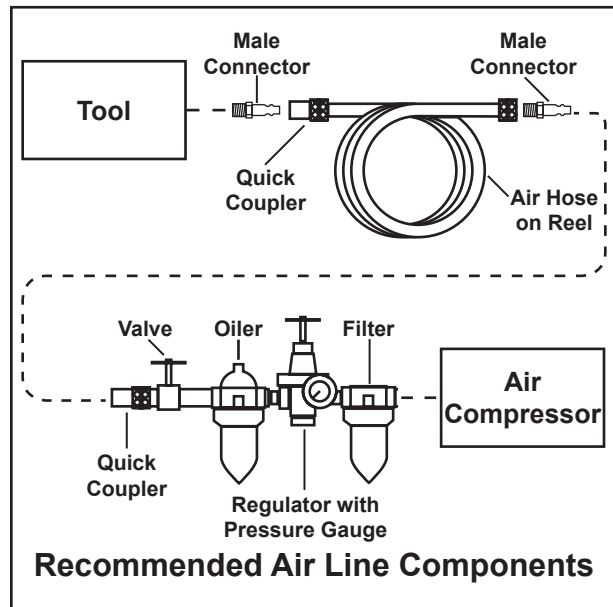

1. Incorporate an in-line oiler, shut-off valve, regulator with pressure gauge, and filter for best service, as shown in the diagram above. **An in-line shut-off valve is an important safety device because it controls the air supply even if the air hose is ruptured.**

Note: If an automatic oiler system is not used, add a few drops of Pneumatic Tool Oil to the airline connection before operation. Add a few more drops after each hour of continual use.

2. Attach an air hose to the compressor's air outlet. Connect the air hose to the air inlet of the tool. Other com-

REV 08j

ponents, such as a connector and quick coupler, will make operation more efficient, but are not required.

⚠WARNING! TO PREVENT SERIOUS INJURY FROM ACCIDENTAL OPERATION:

Do not install a female quick coupler on the tool. Such a coupler contains an air valve that will allow the air tool to retain pressure and operate accidentally after the air supply is disconnected.

Note: Air flow, and therefore tool performance, can be hindered by under-sized air supply components.

3. The air hose must be long enough to reach the work area with enough extra length to allow free movement while working.
4. Make sure the tool's throttle or switch is in the off position; refer to Operation section for description of controls.
5. Close the in-line safety valve between the compressor and the tool.
6. Turn on the air compressor according to the manufacturer's directions and allow it to build up pressure until it cycles off.
7. Adjust the air compressor's output regulator so that the air output is enough to properly power the tool, but the output will not exceed the tool's maximum air pressure at any time. Adjust the pressure gradually, while checking the air output gauge to set the right pressure range.
8. Inspect the air connections for leaks. Repair any leaks found.

9. If the tool will not be used at this time, turn off and detach the air supply, safely discharge any residual air pressure, and release the throttle and/or turn the switch to its off position to prevent accidental operation.

Note: Residual air pressure should not be present after the tool is disconnected from the air supply. However, it is a good safety measure to attempt to discharge the tool in a safe fashion after disconnecting to ensure that the tool is disconnected and un-powered.

OPERATING INSTRUCTIONS



Read the **ENTIRE IMPORTANT SAFETY INFORMATION** section at the beginning of this manual including all text under subheadings therein before set up or use of this product.

Inspect tool before use, looking for damaged, loose, and missing parts. If any problems are found, do not use tool until repaired.

Tool Set Up

⚠️ WARNING TO PREVENT SERIOUS INJURY

FROM ACCIDENTAL OPERATION:

Turn off the tool, detach the air supply, safely discharge any residual air pressure in the tool, and release the throttle and/or turn the switch to its off position before performing any inspection, maintenance, or cleaning procedures.

TO PREVENT SERIOUS INJURY:

Do not adjust or tamper with any control or component in a way not specifically explained within this manual. Improper adjustment can result in tool failure or other serious hazards.

1. To install a bit (with 1/8" shank), loosen the Clamping Nut (22), slide the bit's shank through the Clamping Nut and through the 1/8" Collet (21).

2. Tighten finger tight, then use the two Collet Nut Wrenches, one on the top of the Clamping Nut, and the other on the Collet Holder (18) and tighten the tip securely.

Work Piece and Work Area Set Up

1. Designate a work area that is clean and well-lit. The work area must not allow access by children or pets to prevent injury and distraction.
2. Route the air hose along a safe route to reach the work area without creating a tripping hazard or exposing the air hose to possible damage. The air hose must be long enough to reach the work area with enough extra length to allow free movement while working.
3. Secure loose workpieces using a vise or clamps (not included) to prevent movement while working.
4. There must not be hazardous objects (such as utility lines or foreign objects) nearby that will present a hazard while working.

General Operating Instructions

1. If an automatic oiler is not used, add a few drops of Pneumatic Tool Oil to the air-line connection before use. Add a few more drops after each hour of continual use.
2. Have the desired bit installed in the end of the grinder and secured.
3. Wear ANSI-approved safety glasses.
4. Ensure that the Control Ring (3) is in the "OFF" position. Plug the Male Coupler Plug to an air compressor.

5. Turn the Control Ring (3) slowly to the "ON" position to begin grinding or cutting. The more you turn the knob, the higher the RPM.
6. If the tool requires more force to accomplish the task, verify that the tool receives sufficient, unobstructed airflow (CFM) and increase the pressure (PSI) output of the regulator up to the maximum air pressure rating of this tool.

CAUTION! TO PREVENT TOOL AND ACCESSORY FAILURE, RESULTING IN INJURY:

Do not exceed the tool's maximum air pressure rating.

If the tool still does not have sufficient force at maximum air pressure and sufficient airflow, then a larger tool may be required.

7. To prevent accidents, turn off the tool, detach the air supply, safely discharge any residual air pressure in the tool. Clean external surfaces of the tool with clean, dry cloth, and apply a thin coat of tool oil. Then store the tool indoors out of children's reach.

USER-MAINTENANCE INSTRUCTIONS



Procedures not specifically explained in this manual must be performed only by a qualified technician.

WARNING

TO PREVENT SERIOUS INJURY

FROM ACCIDENTAL OPERATION:

Turn off the tool, detach the air supply, safely discharge any residual air pressure in the tool before performing any inspection, maintenance, or cleaning procedures.

TO PREVENT SERIOUS INJURY FROM TOOL FAILURE:

Do not use damaged equipment. If abnormal noise, vibration, or air leaking occurs, have the problem corrected before further use.



TO PREVENT EXPLOSION:

Lubricate the tool only with specified lubricants. Lubricate the air inlet using only pneumatic tool oil. Lubricate the internal mechanism using only white lithium grease. Other lubricants may damage the mechanism and may be highly flammable, causing an explosion.

explained as part of the regular operation of the air-operated tool.

1. **Daily - Air Supply Maintenance:**
Every day, perform maintenance on the air supply according to the component manufacturers' instructions. Maintenance on the air supply will allow the tool to operate more safely and will also reduce wear on the tool. Any disassembly and cleaning should be done only by a qualified technician.
2. Wipe and brush grinder off after each use. Keep the unit dry and keep the space at either end of the knob free of oil, grease and wood or metal chips.
3. Ensure that the Front Cover (20), Sleeve (19) and Rear End Holder are tightly secured so that air will not escape.
4. Ensure the hose couplings or connectors have air tight connections.

Cleaning and Maintenance

Note: These procedures are in addition to the regular checks and maintenance

Troubleshooting

Problem	Possible Causes	Likely Solutions
Decreased output.	<ol style="list-style-type: none"> 1. Not enough air pressure and/or air flow. 2. Obstructed valve. 3. Incorrect lubrication inadequately lubricated. 4. Blocked air inlet screen (if equipped). 5. Air leaking from loose housing. 6. Mechanism contaminated. 7. Rotor blade wear or damage. 	<ol style="list-style-type: none"> 1. Check for loose connections and make sure that air supply is providing enough air flow (CFM) at required pressure (PSI) to the tool's air inlet. Do not exceed maximum air pressure. 2. Clean around valve to ensure free movement. 3. Lubricate using air tool oil and grease according to directions. 4. Clean air inlet screen of buildup. 5. Make sure housing is properly assembled and tight. 6. Have qualified service technician clean and lubricate mechanism. Install in-line filter in air supply as stated in Initial Set Up: Air Supply. 7. Replace all rotor blades as a set.
Housing heats during use.	<ol style="list-style-type: none"> 1. Incorrect lubrication or not enough lubrication. 2. Worn parts. 	<ol style="list-style-type: none"> 1. Lubricate using air tool oil and grease according to directions. 2. Have qualified service technician inspect internal mechanism and replace parts as needed.
Severe air leakage. (Slight air leakage is normal, especially on older tools.)	<ol style="list-style-type: none"> 1. Cross-threaded housing components. 2. Loose housing. 3. Damaged valve or housing. 4. Dirty, worn or damaged Control Ring (3). 	<ol style="list-style-type: none"> 1. Check for incorrect alignment and uneven gaps. If cross-threaded, disassemble and replace damaged parts before assembly. 2. Tighten housing assembly. If housing cannot be tightened properly, internal parts may be misaligned. 3. Replace damaged components. 4. Clean or replace Control Ring assembly.



Follow all safety precautions whenever diagnosing or servicing the tool. Disconnect air supply before service.

ACCESSORY LIST

Part	Description	Function
23	Collet Nut Wrenches	Tighten/loosen Clamping Nut (22) and Collet Holder (18) for bit installation and removal.
24	Male Coupler Plug	Plug into pressure source.

*SKU or part number may not be available for some accessories.

PLEASE READ THE FOLLOWING CAREFULLY

THE MANUFACTURER AND/OR DISTRIBUTOR HAS PROVIDED THE PARTS LIST AND ASSEMBLY DIAGRAM IN THIS MANUAL AS A REFERENCE TOOL ONLY. NEITHER THE MANUFACTURER OR DISTRIBUTOR MAKES ANY REPRESENTATION OR WARRANTY OF ANY KIND TO THE BUYER THAT HE OR SHE IS QUALIFIED TO MAKE ANY REPAIRS TO THE PRODUCT, OR THAT HE OR SHE IS QUALIFIED TO REPLACE ANY PARTS OF THE PRODUCT. IN FACT, THE MANUFACTURER AND/OR DISTRIBUTOR EXPRESSLY STATES THAT ALL REPAIRS AND PARTS REPLACEMENTS SHOULD BE UNDERTAKEN BY CERTIFIED AND LICENSED TECHNICIANS, AND NOT BY THE BUYER. THE BUYER ASSUMES ALL RISK AND LIABILITY ARISING OUT OF HIS OR HER REPAIRS TO THE ORIGINAL PRODUCT OR REPLACEMENT PARTS THERETO, OR ARISING OUT OF HIS OR HER INSTALLATION OF REPLACEMENT PARTS THERETO.

PARTS LIST

Part	Description	Q'ty
1	Rear End Holder	1
2	Screw	1
3	Control Ring	1
4	O-ring	2
5	O-ring	1
6	Pin	1
7	Hose Plug	1
8	Intake Plate	1
9	Ball Bearing	1
10	Pin	1
11	Bearing Plate	1
12	Rotor	1

PARTS LIST

Part	Description	Q'ty
13	Rotor Blade	Set
14	Cylinder	1
15	Spacer	1
16	Lateral Disc	1
17	Ball Bearing	1
18	Collet Holder	1
19	Sleeve	1
20	Front Cover	1
21	Collet, 1/8"	1
22	Clamping Nut	1
23	Collet Nut Wrenches (not shown)	2
24	Male Coupler Plug (not shown)	1

ASSEMBLY DIAGRAM

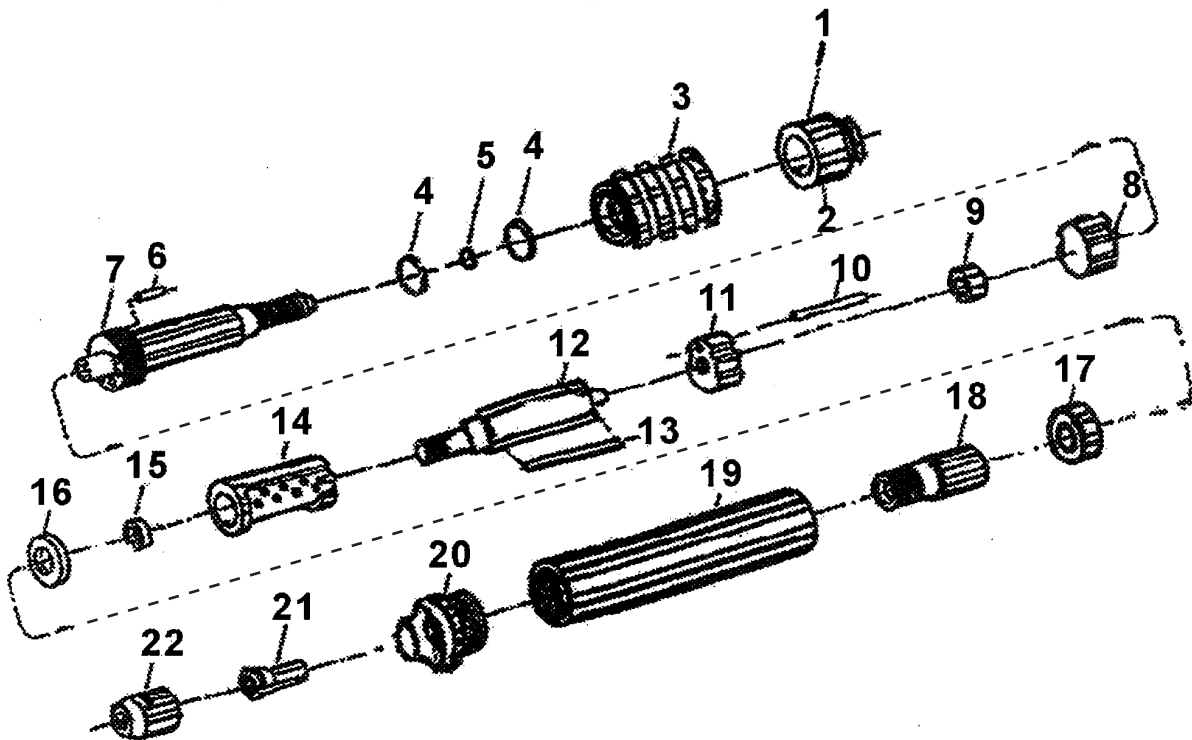

Record Product's Serial Number Here: _____

Note: If product has no serial number, record month and year of purchase instead.

Note: Some parts are listed and shown for illustration purposes only, and are not available individually as replacement parts.

90 Day Warranty

Harbor Freight Tools Co. makes every effort to assure that its products meet high quality and durability standards, and warrants to the original purchaser that this product is free from defects in materials and workmanship for the period of 90 days from the date of purchase. This warranty does not apply to damage due directly or indirectly, to misuse, abuse, negligence or accidents, repairs or alterations outside our facilities, criminal activity, improper installation, normal wear and tear, or to lack of maintenance. We shall in no event be liable for death, injuries to persons or property, or for incidental, contingent, special or consequential damages arising from the use of our product. Some states do not allow the exclusion or limitation of incidental or consequential damages, so the above limitation of exclusion may not apply to you. THIS WARRANTY IS EXPRESSLY IN LIEU OF ALL OTHER WARRANTIES, EXPRESS OR IMPLIED, INCLUDING THE WARRANTIES OF MERCHANTABILITY AND FITNESS.

To take advantage of this warranty, the product or part must be returned to us with transportation charges prepaid. Proof of purchase date and an explanation of the complaint must accompany the merchandise. If our inspection verifies the defect, we will either repair or replace the product at our election or we may elect to refund the purchase price if we cannot readily and quickly provide you with a replacement. We will return repaired products at our expense, but if we determine there is no defect, or that the defect resulted from causes not within the scope of our warranty, then you must bear the cost of returning the product.

This warranty gives you specific legal rights and you may also have other rights which vary from state to state.

Free Manuals Download Website

<http://myh66.com>

<http://usermanuals.us>

<http://www.somanuals.com>

<http://www.4manuals.cc>

<http://www.manual-lib.com>

<http://www.404manual.com>

<http://www.luxmanual.com>

<http://aubethermostatmanual.com>

Golf course search by state

<http://golfingnear.com>

Email search by domain

<http://emailbydomain.com>

Auto manuals search

<http://auto.somanuals.com>

TV manuals search

<http://tv.somanuals.com>