

SERVICE CART WITH TOOL CHEST

Model 47418

ASSEMBLY INSTRUCTIONS



Distributed Exclusively by



3491 Mission Oaks Blvd., Camarillo, CA 93011

Visit our Web site at <http://www.harborfreight.com>

Copyright © 2004 by Harbor Freight Tools®. All rights reserved. No portion of this manual or any artwork contained herein may be reproduced in any shape or form without the express written consent of Harbor Freight Tools.

For technical questions and replacement parts, please call 1-800-444-3353

Specifications

Service Cart with 2 Drawer Tool Chest

Tool Cart Overall Dimensions	30"W X 16-1/8"D X 36"H
Tool Chest Drawer Dimensions	Top Drawer-22-3/8" X 14-3/8" X 2-3/8" Bottom Drawer-22-3/8" X 14-3/8" X 3-1/2"
Maximum Weight for Drawers	66 Lbs. each
Maximum Weight for Tool Tray	220 Lbs.
Finish	Red Powder Coat Sheet Metal w/Chrome Plated Steel Frames
Casters	4 Swivel Wheels-2 w/Locks-Black Rubber/Chrome

Save This Manual

You will need the manual for the safety warnings and precautions, assembly instructions, operating and maintenance procedures, parts list and diagram. Keep your invoice with this manual. Write the invoice number on the inside of the front cover. Keep the manual and invoice in a safe and dry place for future reference.

Safety Warnings and Precautions

WARNING: When using tool, basic safety precautions should always be followed to reduce the risk of personal injury and damage to equipment.

Read all instructions before using this product!

1. **Keep work area clean.** Cluttered areas invite injuries.
2. **Keep children away.** Children must never be allowed in the work area. Do not let children play with this product.
3. **Store idle equipment.** When not in use, this product must be stored in a dry location to inhibit rust. Always lock up tools and keep out of reach of children.
4. **Dress properly.** Do not wear loose clothing or jewelry as they can be caught in moving parts. Protective, electrically nonconductive clothes and nonskid footwear are recommended when working.
5. **Use eye and ear protection.** Always wear ANSI approved impact safety goggles when working around tools.
6. **Do not overreach.** Keep proper footing and balance at all times. Never sit on, or use the Service Cart as a ladder type device for climbing.
7. **Use the right product for the job.** Do not attempt to force a small product or attachment to do the work of a larger industrial product. There are certain applications for which this product was designed. Do not modify this product and do not use this product for a purpose for which it was not intended.
8. **Stay alert.** Watch what you are doing, use common sense. Do not assemble this product when you are tired.

- Check for damaged parts.** Before using any tool, any part that appears damaged should be carefully checked to determine that it will operate properly and perform its intended function. Check for loose parts and any other condition that may affect the operation of this product. Replace loose or worn parts immediately. Any part that is damaged should be properly repaired or replaced by a qualified technician.
- Replacement parts.** When servicing, use only identical replacement parts. Use of any other parts will void the warranty.

Warning: The warnings, cautions, and instructions discussed in this instruction manual cannot cover all possible conditions and situations that may occur. It must be understood by the operator that common sense and caution are factors which cannot be built into this product, but must be supplied by the operator.

Unpacking

When unpacking, check to make sure the following parts are included. If any parts are missing or broken, please call Harbor Freight Tools at the number on the cover of this manual.

Assembly Instructions

- Assemble all parts on a smooth surface to avoid scratching.
- Select the shorter Side Brace (3) for the left side and the longer Side Brace (3) for the right side. Attach the lower Tray (2) to the Side Braces (3) by matching up the holes and securing with Bolts (1), through Side Brace (3). Secure with Washers (11), Spring Washers (12), and Nuts (13). Finger tighten. **See Figure A.**
- In the center of the Side Brace (3), attach Support Brace (7) by threading Bolt (1) through Side Brace (3). Secure in place with Washer (11), Spring Washer (12), and Nut (13). Repeat for other side. **See Assembly Drawing.** Tighten all hardware.

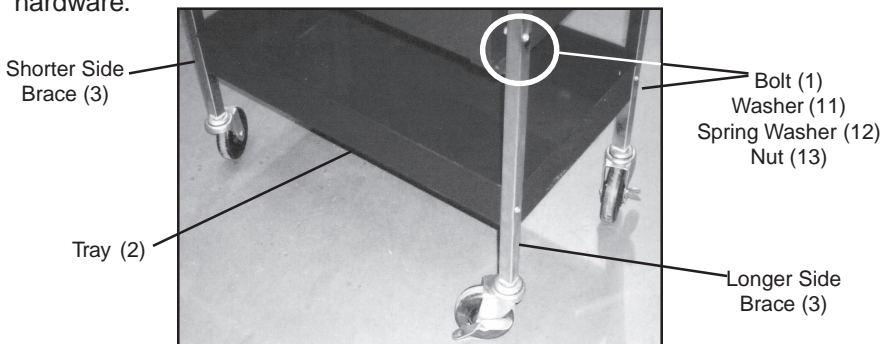

Figure A

4. Position the Tool Chest (8) between the two Side Braces (3), resting the Tool Chest on the Support Braces (7). From the underside of the Tool Chest (8) match up the holes on the Tool Chest and those in the Support Braces (7). Put Washer (14) on Bolt (15) and thread bolt into the bottom of the Tool Chest and Support Braces. **See Figures A & B.**

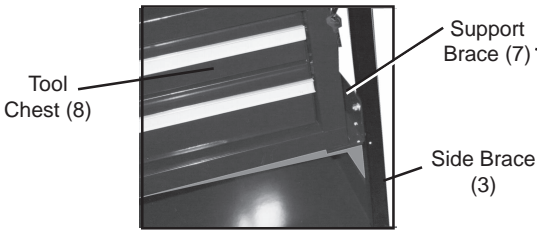

Figure B

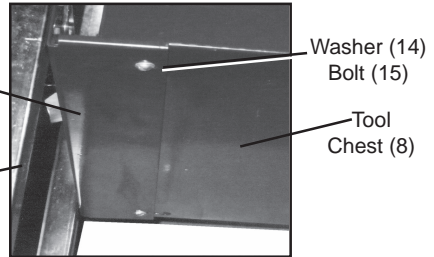

Figure C (View from Underneath)

5. Attach the Upper Tray (2) by matching up the holes and securing with Bolts (1) threaded through the Side Braces (3). Secure with Washers (11), Spring Washers (12), and Nuts (13) on the inside of the Tray. Tighten hardware. **See Figures C & D.**

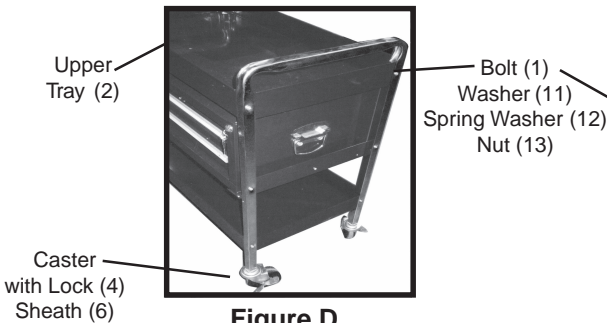

Figure D

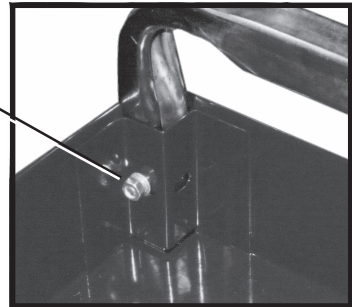

Figure E

6. Place Caster with Locks (4) and Sheath (6) into the longer side Brace (3). The longer Side Brace acts as a handle for the Service Cart with Tool Chest. Place Casters without Locks (5) and Sheath (6) into the shorter Side Brace (3). **See Figure F.** (When not repositioning Service Cart, use the locks on the Casters (4). Unlock to move Cart). **Caution:** Casters without Locks (5) can still move to the right or left. **See Figure D.**

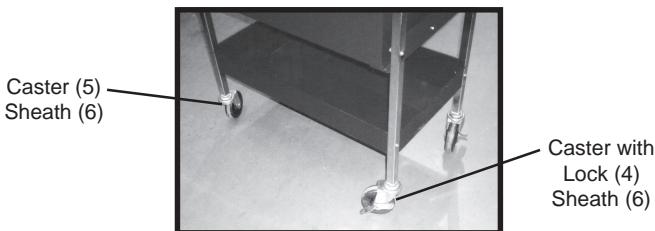

Figure F

7. Objects need to be distributed evenly in the Tool Chest drawers to avoid tipping. Do not overload Trays (2) when moving Service Cart.

Parts List

Part #	Description	Qty.
1	Bolt M6 x 32	12
2	Tray (One Shorter than Other)	2
3	Chrome Side Brace	2
4	Caster With Locks	2
5	Caster Without Locks	2
6	Sheath	4
7	Support Brace	2
8	Tool Chest	1

Part #	Description	Qty.
9	Handle	2
10	Bolt M8 x 15	4
11	Washer 6	12
12	Spring Washer 6	12
13	Nut M6	12
14	Washer 5	4
15	Bolt M5 x 8	4

Assembly Drawing

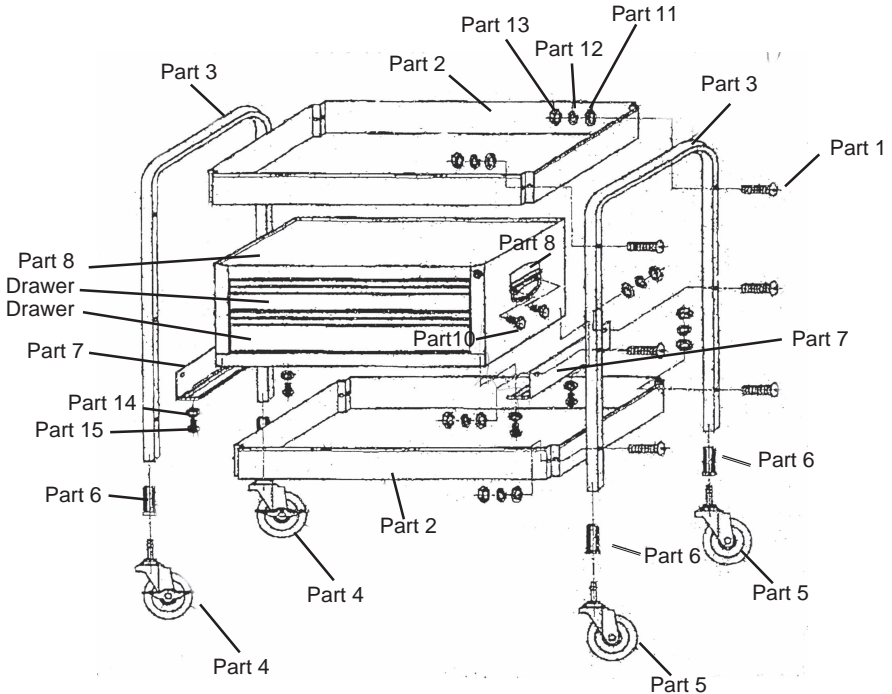

PLEASE READ THE FOLLOWING CAREFULLY

THE MANUFACTURER AND/OR DISTRIBUTOR HAS PROVIDED THE PARTS DIAGRAM IN THIS MANUAL AS A REFERENCE TOOL ONLY. NEITHER THE MANUFACTURER NOR DISTRIBUTOR MAKES ANY REPRESENTATION OR WARRANTY OF ANY KIND TO THE BUYER THAT HE OR SHE IS QUALIFIED TO MAKE ANY REPAIRS TO THE PRODUCT OR THAT HE OR SHE IS QUALIFIED TO REPLACE ANY PARTS OF THE PRODUCT. IN FACT, THE MANUFACTURER AND/OR DISTRIBUTOR EXPRESSLY STATES THAT ALL REPAIRS AND PARTS REPLACEMENTS SHOULD BE UNDERTAKEN BY CERTIFIED AND LICENSED TECHNICIANS AND NOT BY THE BUYER. THE BUYER ASSUMES ALL RISK AND LIABILITY ARISING OUT OF HIS OR HER REPAIRS TO THE ORIGINAL PRODUCT OR REPLACEMENT PARTS THERETO, OR ARISING OUT OF HIS OR HER INSTALLATION OF REPLACEMENT PARTS THERETO.

NOTE: Some parts are listed and shown for illustration purposes only and are not available individually as replacement parts.

Free Manuals Download Website

<http://myh66.com>

<http://usermanuals.us>

<http://www.somanuals.com>

<http://www.4manuals.cc>

<http://www.manual-lib.com>

<http://www.404manual.com>

<http://www.luxmanual.com>

<http://aubethermostatmanual.com>

Golf course search by state

<http://golfingnear.com>

Email search by domain

<http://emailbydomain.com>

Auto manuals search

<http://auto.somanuals.com>

TV manuals search

<http://tv.somanuals.com>