

CHICAGO[®]

Electric

MULTI-PURPOSE FLOOR MACHINE

Model 94280

ASSEMBLY AND OPERATING INSTRUCTIONS



Due to continuing improvements, actual product may differ slightly from the product described herein.



3491 Mission Oaks Blvd., Camarillo, CA 93011
Visit our Web site at: <http://www.harborfreight.com>

**TO PREVENT SERIOUS INJURY,
READ AND UNDERSTAND ALL WARNINGS
AND INSTRUCTIONS BEFORE USE.**

Copyright © 2006 by Harbor Freight Tools[®]. All rights reserved. No portion of this manual or any artwork contained herein may be reproduced in any shape or form without the express written consent of Harbor Freight Tools.

For technical questions, please call 1-800-444-3353.

PRODUCT SPECIFICATIONS

Electrical Requirements	115 V~ / 60 Hz / 250 W
Motor	Single Speed / 0.3 HP / 150 RPM
Power Plug/Cord	3-Prong with Ground 18 AWG x 3 C SJTX x 19 Ft.
Dimensions	10" Outside Diameter Base (11" O.D. w/Brush Attached) 8-1/2" Wide at Wheels (9" Wide at Axle) 35" Long Tube Handle w/Yoke 12-1/2" Wide "T" Handle 48-3/4" High (From Floor to Handle)
Accessories	11" Diameter Carpet Brush (Black w/Slip Fit) 11" Diameter Floor Brush (Green/White w/Slip Fit) 12" Diameter Foam Pad (White w/Hook & Loop)
Weight	41 Pounds

SAVE THIS MANUAL

You will need this manual for the safety warnings and precautions, assembly, operating, inspection, maintenance and cleaning procedures, parts list and assembly diagram. Keep your invoice with this manual. Write the invoice number on the inside of the front cover. Keep this manual and invoice in a safe and dry place for future reference.

GENERAL SAFETY RULES



READ AND UNDERSTAND ALL INSTRUCTIONS
Failure to follow all instructions listed below may result in
electric shock, fire, and/or serious injury.
SAVE THESE INSTRUCTIONS

WORK AREA

1. **Keep your work area clean and well lit.** Cluttered benches and dark areas invite accidents.
2. **Do not operate power tools in explosive atmospheres, such as in the presence of flammable liquids, gases, or dust.** Power tools create sparks which may ignite the dust or fumes.
3. **Keep bystanders, children, and visitors away while operating a power tool.** Distractions can cause you to lose control. Provide barriers or shields as needed.

ELECTRICAL SAFETY

1. **Grounded tools must be plugged into an outlet properly installed and grounded in accordance with all codes and ordinances. Never remove the grounding prong or modify the plug in any way. Do not use any adapter plugs. Check with a qualified electrician if you are in doubt as to whether the outlet is properly grounded.** If the tools should electrically malfunction or break down, grounding provides a low resistance path to carry electricity away from the user.
2. **Double insulated tools are equipped with a polarized plug (one blade is wider than the other). This plug will fit in a polarized outlet only one way. If the plug does not fit fully in the outlet, reverse the plug. If it still does not fit, contact a qualified electrician to install a polarized outlet. Do not change the plug in any way.** Double insulation eliminates the need for the three wire grounded power cord and grounded power supply system.
3. **Avoid body contact with grounded surfaces such as pipes, radiators, ranges, and refrigerators.** There is an increased risk of electric shock if your body is grounded.
4. **Do not expose power tools to rain or wet conditions.** Water entering a power tool will increase the risk of electric shock.
5. **Do not abuse the Power Cord. Never use the Power Cord to carry the tools or pull the Plug from an outlet. Keep the Power Cord away from heat, oil, sharp edges, or moving parts. Replace damaged Power Cords immediately.** Damaged Power Cords increase the risk of electric shock.
6. **When operating a power tool outside, use an outdoor extension cord marked “W-A” or “W”.** These extension cords are rated for outdoor use, and reduce the risk of electric shock.

PERSONAL SAFETY

1. **Stay alert. Watch what you are doing, and use common sense when operating this product. Do not use the Floor Machine while tired or under the influence of drugs, alcohol, or medication.** A moment of inattention while operating this product may result in serious personal injury.
2. **Dress properly. Do not wear loose clothing or jewelry. Contain long hair. Keep your hair, clothing, and gloves away from moving parts.** Loose clothes, jewelry, or long hair can be caught in moving parts.
3. **Avoid accidental starting.** Make sure the Power Cord remains unplugged from its electrical outlet until this product is completely assembled and ready to use.
4. **Do not overreach. Keep proper footing and balance at all times.** Proper footing and balance enables better control of this product in unexpected situations.

5. **Use safety equipment. Wear eye protection when assembling this product.** Non-skid safety shoes must be used for appropriate conditions.

TOOL USE AND CARE



1. **Disconnect the Power Cord Plug from the power source before making any adjustments, changing accessories, or storing the Floor Machine.** Such preventive safety measures reduce the risk of starting the unit accidentally.
2. **Store idle equipment out of reach of children and other untrained persons.** Electrically powered products are dangerous in the hands of untrained users.
3. **Check for misalignment or binding of moving parts, breakage of parts, and any other condition that may affect this product's operation. If damaged, have the Floor Machine serviced before using.** Many accidents are caused by poorly maintained equipment.

SERVICE

1. **Service must be performed only by qualified repair personnel.** Service or maintenance performed by unqualified personnel could result in a risk of injury.
2. **When servicing this product, use only identical replacement parts. Follow instructions in the "Inspection, Maintenance, And Cleaning" section of this manual.** Use of unauthorized parts or failure to follow maintenance instructions may create a risk of electric shock or injury.

SPECIFIC SAFETY RULES

1. **Maintain labels and nameplates on the Floor Machine.** These carry important information. If unreadable or missing, contact Harbor Freight Tools for a replacement.
2.  **Wear ANSI-approved safety impact eye goggles and non-slip footwear when using the Floor Machine.** Using personal safety devices reduce the risk for injury.
3. **Maintain a safe environment.** Keep the area well lit. Make sure there is adequate surrounding space. Always keep the area free of obstructions, grease, oil, trash, and other debris. Do not use an electrically powered product in areas near flammable chemicals, dusts, and vapors.
4. **Never leave the Floor Machine unattended when it is plugged into an electrical outlet.** Turn off the Floor Machine and unplug the tool before leaving.
5. **Carefully inspect the condition of the Floor Machine before use, and check the tool continually during use.** If any damage is noted, stop immediately and repair or replace the Floor Machine.

6.  **Avoid electrical shock.** Make sure the Floor Machine is unplugged from its electrical outlet prior to performing any inspection, maintenance, or cleaning procedures. Do not use the Floor Machine in the rain or in wet conditions. Plug the Power Cord of this unit only into a 3-hole, 115 volt, Ground Fault Circuit Interrupter (GFCI), electrical outlet for additional protection from electric shock.
7. **Use the right product for the job.** There are certain applications for which this product was designed. Do not use small tools, equipment, or accessories to do the work of larger industrial tools, equipment, or accessories. Do not use this product for a purpose for which it was not intended.
8. **Do not allow children or other unauthorized people to handle or play with this product.**
9. **Industrial applications must follow OSHA requirements.**
10. **To reduce the risk of fire, use only commercially available floor cleaners and waxes.**
11.  **WARNING!** People with pacemakers should consult their physician(s) before using this product. Electromagnetic fields in close proximity to a heart pacemaker could cause interference to or failure of the pacemaker. In addition, people with pacemakers should adhere to the following: Avoid operating power tools alone. Don't use a power tool with the Power Switch locked on. If powered via a Power Cord be certain that the tool is properly grounded. A ground fault interrupt (GFCI) system is also a good precaution. This inexpensive device is a good safety measure because it prevents a sustained electrical shock. Properly maintain and inspect all tools before use to avoid electrical shock.
12.  **WARNING!** The warnings and cautions discussed in this manual cannot cover all possible conditions and situations that may occur. It must be understood by the operator that common sense and caution are factors which cannot be built into this product, but must be supplied by the operator.

SAVE THESE INSTRUCTIONS

GROUNDING

 **WARNING!**

Improperly connecting the grounding wire can result in the risk of electric shock. Check with a qualified electrician if you are in doubt as to whether the outlet is properly grounded. Do not modify the power cord plug provided with the tool. Never remove the grounding prong from the plug. Do not use the tool if the power cord or plug is damaged. If damaged, have it repaired by a service facility before use. If the plug will not fit the outlet, have a proper outlet installed by a qualified electrician.

GROUNDING TOOLS: TOOLS WITH THREE PRONG PLUGS

1. Tools marked with “Grounding Required” have a three wire cord and three prong grounding plug. The plug must be connected to a properly grounded outlet. If the tool should electrically malfunction or break down, grounding provides a low resistance path to carry electricity away from the user, reducing the risk of electric shock. **(See 3-Prong Plug and Outlet.)**
2. The grounding prong in the plug is connected through the green wire inside the cord to the grounding system in the tool. The green wire in the cord must be the only wire connected to the tool’s grounding system and must never be attached to an electrically “live” terminal. **(See 3-Prong Plug and Outlet.)**
3. Your tool must be plugged into an appropriate outlet, properly installed and grounded in accordance with all codes and ordinances. The plug and outlet should look like those in the following illustration. **(See 3-Prong Plug and Outlet.)**

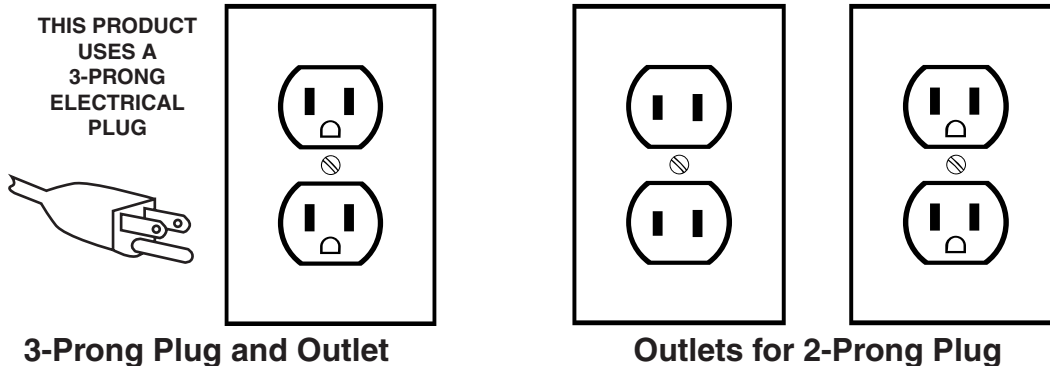

DOUBLE INSULATED TOOLS: TOOLS WITH TWO PRONG PLUGS

1. Tools marked “Double Insulated” do not require grounding. They have a special double insulation system which satisfies OSHA requirements and complies with the applicable standards of Underwriters Laboratories, Inc., the Canadian Standard Association, and the National Electrical Code. **(See Outlets for 2-Prong Plug.)**

2. Double insulated tools may be used in either of the 120 volt outlets shown in the preceding illustration. **(See Outlets for 2-Prong Plug.)**



EXTENSION CORDS

1. ***Grounded*** tools require a three wire extension cord. ***Double Insulated*** tools can use either a two or three wire extension cord.
2. As the distance from the supply outlet increases, you must use a heavier gauge extension cord. Using extension cords with inadequately sized wire causes a serious drop in voltage, resulting in loss of power and possible tool damage. **(See Table A.)**
3. The smaller the gauge number of the wire, the greater the capacity of the cord. For example, a 14 gauge cord can carry a higher current than a 16 gauge cord. **(See Table A.)**
4. When using more than one extension cord to make up the total length, make sure each cord contains at least the minimum wire size required. **(See Table A.)**
5. If you are using one extension cord for more than one tool, add the nameplate amperes and use the sum to determine the required minimum cord size. **(See Table A.)**
6. If you are using an extension cord outdoors, make sure it is marked with the suffix "W-A" ("W" in Canada) to indicate it is acceptable for outdoor use.
7. Make sure your extension cord is properly wired and in good electrical condition. Always replace a damaged extension cord or have it repaired by a qualified electrician before using it.
8. Protect your extension cords from sharp objects, excessive heat, and damp or wet areas.

RECOMMENDED MINIMUM WIRE GAUGE FOR EXTENSION CORDS* (120 OR 240 VOLT)					
NAMEPLATE AMPERES (at full load)	EXTENSION CORD LENGTH				
	25 Feet	50 Feet	75 Feet	100 Feet	150 Feet
0 – 2.0	18	18	18	18	16
2.1 – 3.4	18	18	18	16	14
3.5 – 5.0	18	18	16	14	12
5.1 – 7.0	18	16	14	12	12
7.1 – 12.0	18	14	12	10	-
12.1 – 16.0	14	12	10	-	-
16.1 – 20.0	12	10	-	-	-

TABLE A * Based on limiting the line voltage drop to five volts at 150% of the rated amperes.

SYMBOLGY

	Double Insulated
	Canadian Standards Association
	Underwriters Laboratories, Inc.
V~	Volts Alternating Current
A	Amperes
n ₀ xxxx/min.	No Load Revolutions per Minute (RPM)

UNPACKING

When unpacking, check to make sure all the parts shown on the **Parts List at the end of the manual** are included. If any parts are missing or broken, please call Harbor Freight Tools at the number shown on the cover of this manual as soon as possible.

ASSEMBLY

Note: For additional information regarding the parts listed in the following pages, refer to the **Assembly Diagram at the end of the manual.**

1. **CAUTION!** Always make sure the Floor Machine is disconnected from its electrical outlet prior to assembling the tool, changing accessories, or performing service to the product.

2.  **Wear ANSI-approved safety impact eye goggles and non-slip footwear when using the Floor Machine.** Using personal safety devices reduce the risk for injury.

Install the Handle Tube And Locking Pin

1. Turn the Chassis (1) upside-down and gently press the tab on the Screw Box (10) from underneath using a screwdriver, see lower left. Remove the Screw Box.

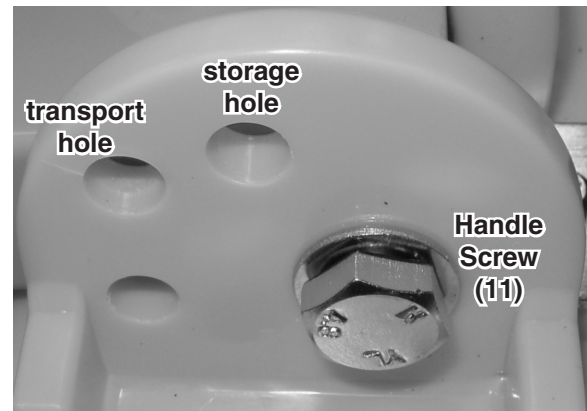
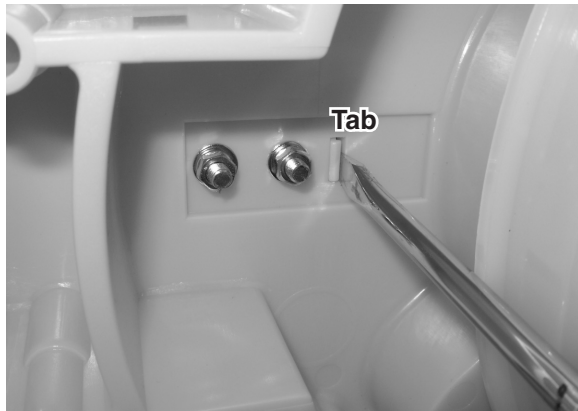

2. Align the mounting holes in the lower portion of the Handle Tube (21) with the front two mounting holes in the bracket at the rear of the Floor Machine's Chassis (1). This is the location that the Handle Screw is shown to the top left. Then secure the Handle Tube to the Chassis, using one Handle Screw (11), two Flat Washers (12), and one Hex Lock Nut (13). Replace the Screw Box (10).
3. For storage, raise the Handle Tube (21) to its highest point. Then, insert the Locking Pin (16) through the storage hole shown above.
4. For transport, raise the Handle Tube (21) to its highest point. Then, insert the Locking Pin (16) through the transport hole shown above.

Install A Carpet Brush, Floor Brush, Or Foam Pad

Note: The Carpet Brush (51) and Floor Brush (52) are typically used for cleaning floor surfaces. In addition, the Floor Brush may be used to apply wax to a floor surface. The Foam Pad (54) is used for buffing the floor surface after wax has been applied.

1. Set the Carpet Brush (51), Floor Brush (52), or Pad (54) level on the floor surface. **(See Figure E, next page.)**
2. With both hands pick up the Chassis (1) of the Floor Machine and align the machine's Brush Holder Pad (35) with the Carpet Brush (51), Floor Brush (52), or Pad (54). Then push down firmly on the Chassis to secure the Brush or Pad in place. **NOTE:** The Brushes and Foam Pad fit snugly onto the Brush Holder Pad, and may require additional effort to install. **(See Figure E, next page.)**

OPERATION

1. Refer to the floor cleaner/wax *manufacturer's instructions* for the proper amount and method of dispensing floor cleaner/wax on the floor surface.
2. Plug the Power Cord (34A) of the Floor Machine into the nearest 115 volt, grounded, electrical outlet. In order to keep the Power Cord out of the way, hang it over your shoulder.

(See Figure E.)

3. Position the Carpet Brush (51), Floor Brush (52), or Foam Pad (54) on the floor surface. **(See Figure E.)**

4. Remove the Locking Pin (16) from the holes in the bracket and place it in the hole in the housing.

5. **NOTE:** Always start and stop the Floor Machine while it is positioned firmly against the surface of the floor.

Failure to do so may result in the Carpet Brush (51), Floor Brush (52), or Pad (54) being thrown from the Brush Holder Pad (35). **(See Figure E.)**

6. Grip the Front Handle (26) firmly with both hands. Then turn the Power Switch (29) to its “**ON**” position and allow the Brush Holder Pad (35) to orbit at full speed. **(See Figure E.)**

7. Slowly move the Floor Machine in broad sweeping strokes in a criss-cross pattern along the floor surface. Apply the floor cleaner/wax evenly over the surface of the floor, and add additional floor cleaner/wax as needed.

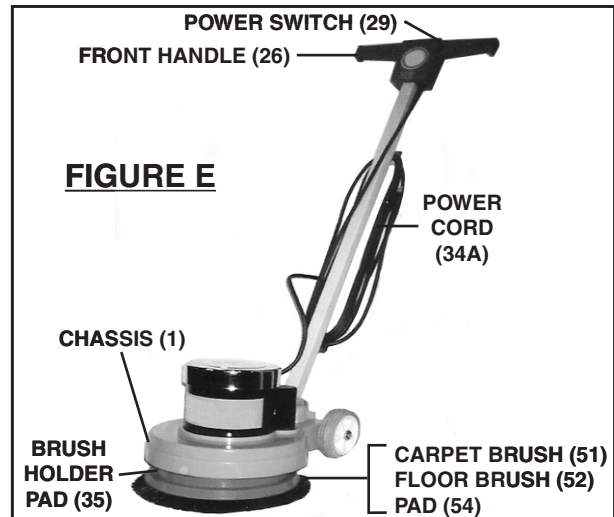

8. After the floor cleaner/wax has been applied to the floor surface, turn the Power Switch (29) to its “**OFF**” position. Then unplug the Power Cord (34A) from the 115 volt, grounded, electrical outlet. **(See Figure E.)**



To Remove The Carpet Brush, Floor Brush, Or Foam Pad:

Lay the Floor Machine on its back with its Front Handle (26) lying on the floor surface. With both hands, pull out and remove the Carpet Brush (51), Floor Brush (52), or Foam Pad (54).

INSPECTION, MAINTENANCE, AND CLEANING

1.  **WARNING!** Make sure the Floor Machine is disconnected from its electrical outlet prior to performing any inspection, maintenance, or cleaning procedures.
2. **Before each use**, inspect the general condition of the Floor Machine. Check for cracked or broken parts, damaged electrical wiring, and any other condition that may affect safe operation. If abnormal noise or vibration occurs, have the problem corrected before further use.
Do not use damaged equipment.
3. **After each use**, remove the Carpet Brush (51), Floor Brush (52), or Pad (54). This will allow the Brushes and Pad to dry and retain their original shape. To prolong the life and shape of the Brushes and Pad, store them face up.
4. **To clean:** Use a clean cloth and mild detergent to clean the exterior of the Floor Machine. Do not immerse the Floor Machine in liquid.
5. **When storing**, make sure to store the Floor Machine in a clean, dry, safe location out of reach of children and other unauthorized people.
6.  **CAUTION!** All maintenance, service, or repairs not mentioned in this manual must only be performed by a qualified service technician.

TROUBLESHOOTING

Problem	Possible Cause	Possible Solution
Machine will not run.	<ol style="list-style-type: none"> 1. Not firmly plugged into electrical outlet. 2. Capacitor (47A) malfunction. 	<ol style="list-style-type: none"> 1. Make sure the power plug is plugged into a working, 115 volt, grounded, electrical outlet. 2. Have a qualified technician check capacitor.
Machine bounces.	<ol style="list-style-type: none"> 1. Using carpet brush (51) on dry surface without dry shampoo or wet shampoo. 2. Carpet brush (51) or brush holder pad (35) not properly in place. 	<ol style="list-style-type: none"> 1. Apply dry shampoo or wet shampoo to floor surface. 2. Position carpet brush and/or brush holder pad level.
Irregular noises when running.	<ol style="list-style-type: none"> 1. Handle Screw (11) is loose. 2. Pad Screws (25) are loose. 	<ol style="list-style-type: none"> 1. Retighten Handle Screw. 2. Retighten Pad Screws.

PLEASE READ THE FOLLOWING CAREFULLY

THE MANUFACTURER AND/OR DISTRIBUTOR HAS PROVIDED THE PARTS LIST AND ASSEMBLY DIAGRAM IN THIS MANUAL AS A REFERENCE TOOL ONLY. NEITHER THE MANUFACTURER OR DISTRIBUTOR MAKES ANY REPRESENTATION OR WARRANTY OF ANY KIND TO THE BUYER THAT HE OR SHE IS QUALIFIED TO MAKE ANY REPAIRS TO THE PRODUCT, OR THAT HE OR SHE IS QUALIFIED TO REPLACE ANY PARTS OF THE PRODUCT. IN FACT, THE MANUFACTURER AND/OR DISTRIBUTOR EXPRESSLY STATES THAT ALL REPAIRS AND PARTS REPLACEMENTS SHOULD BE UNDERTAKEN BY CERTIFIED AND LICENSED TECHNICIANS, AND NOT BY THE BUYER. THE BUYER ASSUMES ALL RISK AND LIABILITY ARISING OUT OF HIS OR HER REPAIRS TO THE ORIGINAL PRODUCT OR REPLACEMENT PARTS THERETO, OR ARISING OUT OF HIS OR HER INSTALLATION OF REPLACEMENT PARTS THERETO.

PARTS LIST

Part	Description	Q'ty	Part	Description	Q'ty
1	Chassis	1	28	Cord Clamp	1
2	Label	1	29	Power Switch	1
3A	Motor (115 Volt / 60 Hz)	1	30	Hex Nut (M4)	4
4	Circlip (#10)	2	31	Warning Label	1
5	Flat Washer (#10)	4	32	Hex Nut (M5)	4
6	Spacer (#10)	2	33	Cord Protector	1
7	Wheel	2	34A	Power Cord	1
8	Motor Shield	1	35	Brush Holder Pad	1
9	Trademark	1	36	Bearing Core	1
10	Screw Box	1	37	Bearing (6006-2RS)	1
11	Handle Screw (M8 x 55)	1	38	Spacer	2
12	Flat Washer (#8 x #16)	2	39	Bearing Box	1
13	Hex Lock Nut (M8)	1	40	Plate w/Counterweights	1
14	Screw (M5 x 18)	2	41	Screw (M6 x 20)	2
15	Plate	3	42	Screw (M6 x 18)	4
16	Locking Pin	1	43	Spacer (#6)	4
17	Cord Clip	1	44	Flat Washer (#6)	4
18	P-Clip	2	45	Axle	1
19	Cord Hook	2	46	Data Plate	1
20	Pop-Rivet Handle (#4)	4	47A	Capacitor	1
21	Handle Tube	1	48	Capacitor Box	1
22	Grounding Warning Label	1	49	Screw (M4 x 6)	2
23	Screw (M5 x 40)	2	50	Sponge Pad	4
24	Trademark	1	51	11" Dia. Carpet Brush (Black)	1
25	Pad Screw (M4 x 12)	8	52	11" Dia. Floor Brush (Green/White)	1
26	Front Handle	1	54	12" Dia. Foam Pad (White)	1
27	Screw (ST3.5 x 16)	2			

Note: Some parts are listed and shown for illustration purposes only, and are not available individually as replacement parts.

ASSEMBLY DIAGRAM

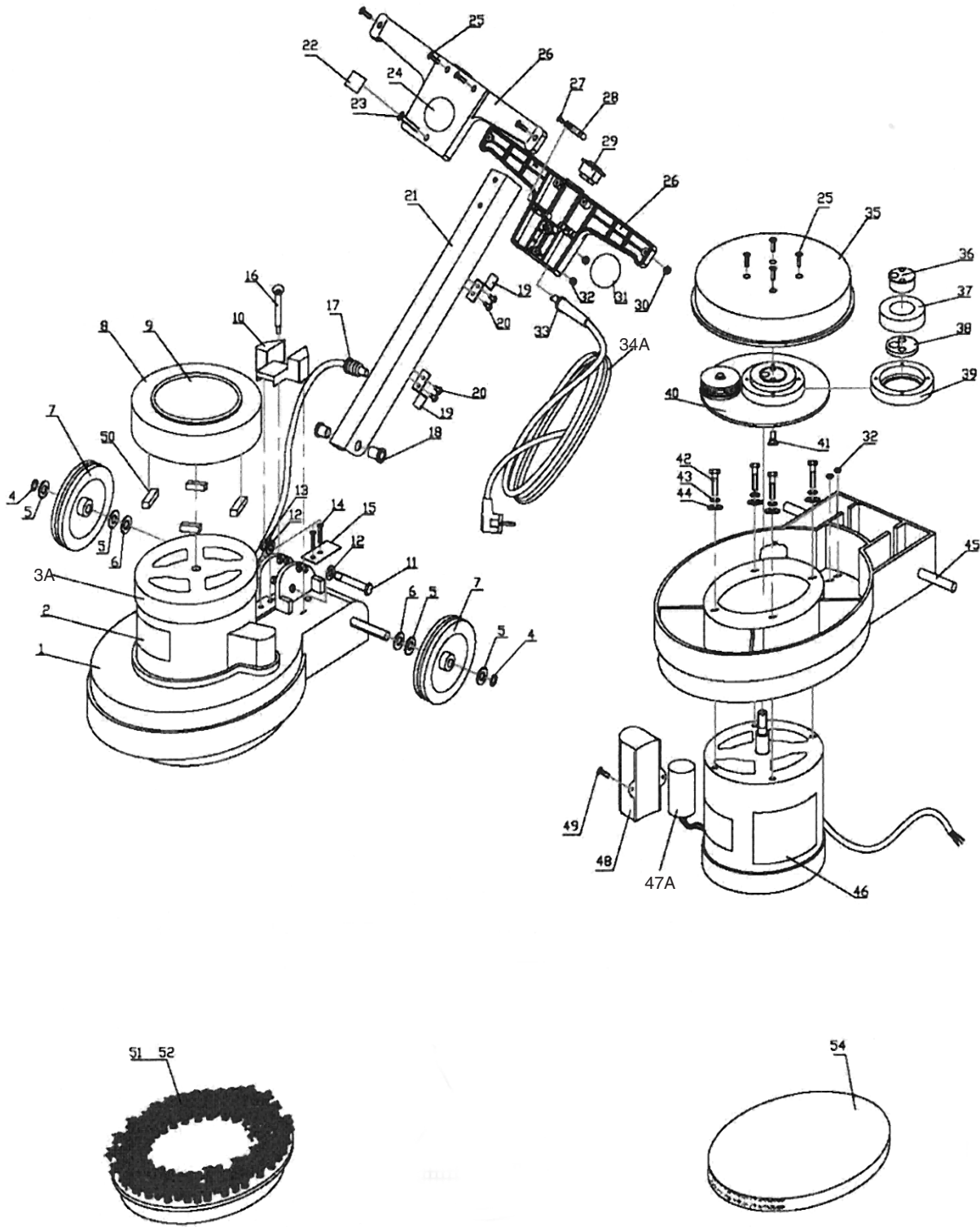

LIMITED 90 DAY WARRANTY

Harbor Freight Tools Co. makes every effort to assure that its products meet high quality and durability standards, and warrants to the original purchaser that this product is free from defects in materials and workmanship for the period of 90 days from the date of purchase. This warranty does not apply to damage due directly or indirectly, to misuse, abuse, negligence or accidents, repairs or alterations outside our facilities, criminal activity, improper installation, normal wear and tear, or to lack of maintenance. We shall in no event be liable for death, injuries to persons or property, or for incidental, contingent, special or consequential damages arising from the use of our product. Some states do not allow the exclusion or limitation of incidental or consequential damages, so the above limitation of exclusion may not apply to you. THIS WARRANTY IS EXPRESSLY IN LIEU OF ALL OTHER WARRANTIES, EXPRESS OR IMPLIED, INCLUDING THE WARRANTIES OF MERCHANTABILITY AND FITNESS.

To take advantage of this warranty, the product or part must be returned to us with transportation charges prepaid. Proof of purchase date and an explanation of the complaint must accompany the merchandise. If our inspection verifies the defect, we will either repair or replace the product at our election or we may elect to refund the purchase price if we cannot readily and quickly provide you with a replacement. We will return repaired products at our expense, but if we determine there is no defect, or that the defect resulted from causes not within the scope of our warranty, then you must bear the cost of returning the product.

This warranty gives you specific legal rights and you may also have other rights which vary from state to state.

3491 Mission Oaks Blvd. • PO Box 6009 • Camarillo, CA 93011 • (800) 444-3353

Free Manuals Download Website

<http://myh66.com>

<http://usermanuals.us>

<http://www.somanuals.com>

<http://www.4manuals.cc>

<http://www.manual-lib.com>

<http://www.404manual.com>

<http://www.luxmanual.com>

<http://aubethermostatmanual.com>

Golf course search by state

<http://golfingnear.com>

Email search by domain

<http://emailbydomain.com>

Auto manuals search

<http://auto.somanuals.com>

TV manuals search

<http://tv.somanuals.com>