

Harmar
MOBILITY

Installation and Owner's Manual

AL001



Owners Manual

Rev.1 - 2008



Read manual thoroughly before attempting to install or operate lift.

This manual has been provided to assist you with lift installation and operation. For further assistance please contact your authorized Harmar Mobility dealer or Harmar's Technical Services department.

Tel: 800.833.0478

Fax: 866.234.0478

Email: tech@harmar.com

Dealer:

Serial Number:

AL001 Users Manual

Harmar Mobility
Rev.1 June 2008



Please read the manual before using.

WARNING!

A warning indicates a potentially dangerous situation, which if not avoided, could result in death or serious injury.

1. Read all instructions and save them for future reference.
2. Follow all warnings and instructions marked on the product.
3. Do not ride any vehicle while loading onto the carrier.
4. Do not stand on the carrier.
5. Never exceed vehicle tongue weight ratings.
6. Always store the carrier in a safe place.
7. Only use the carrier with Class 2, 3 or larger hitch.
8. Improper use, storage or installation of carrier could result in death or serious injury.

9. Do not put the product on any kinds of trailers.
10. Carrying capacity is limited to 500 lbs. max.

Assembly Instructions

Tools Need:

- 5/8" wrench
- 1/2" wrench
- 3/4" wrench
- 9/16" wrench
- Phillips screwdriver

Step.1

Insert the hitch into the carrier rack. See the figure

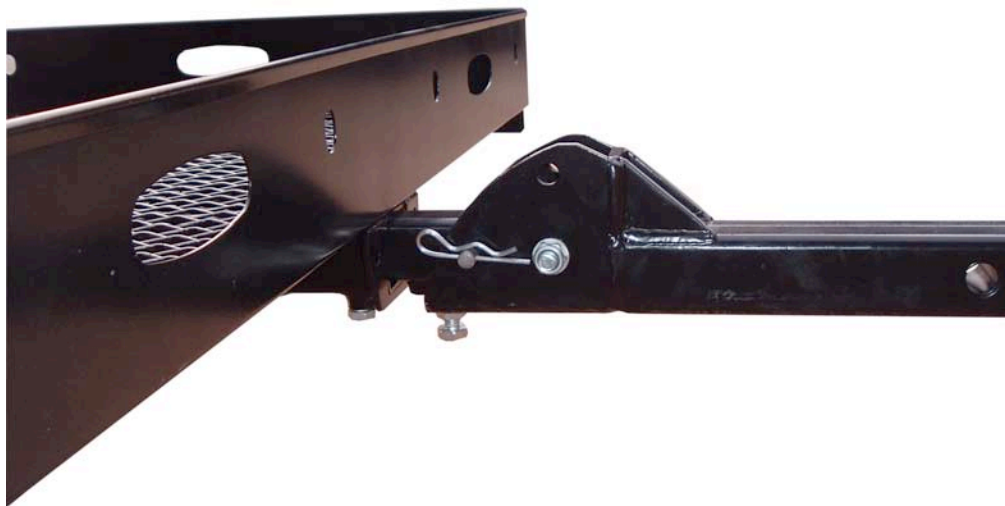

Step.2

Insert four 3/8"x7/8" bolts on the bottom of your carrier tube. Tighten bolts firm with a wrench. See the figure.

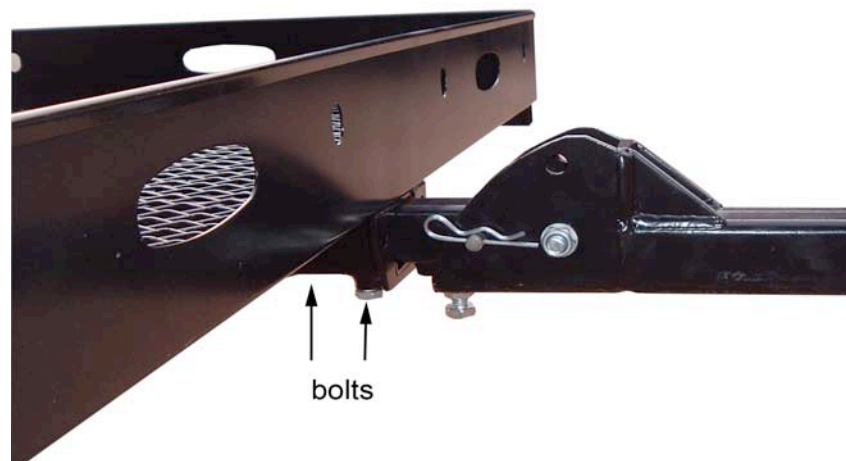

Step.3

Screw spring pull pin into carrier. Add reflectors. See the figure.

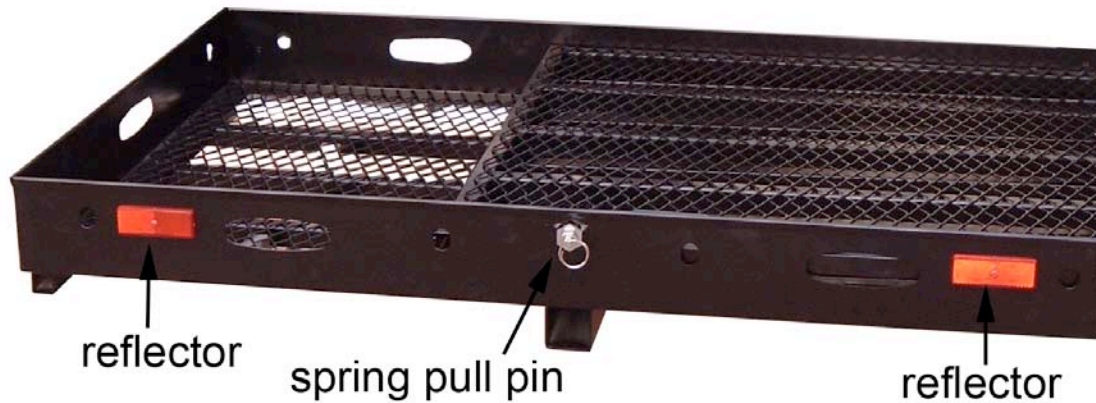

Step.4

Screw spring pull pin into jam nut. Screw spring pull pin into ramp bracket. Bolt bracket to frame. Secure with nuts and lock washers. See the figure.

NOTE! To prevent loosening of the spring pull pin, torque the jam nut tightly against the ramp bracket.

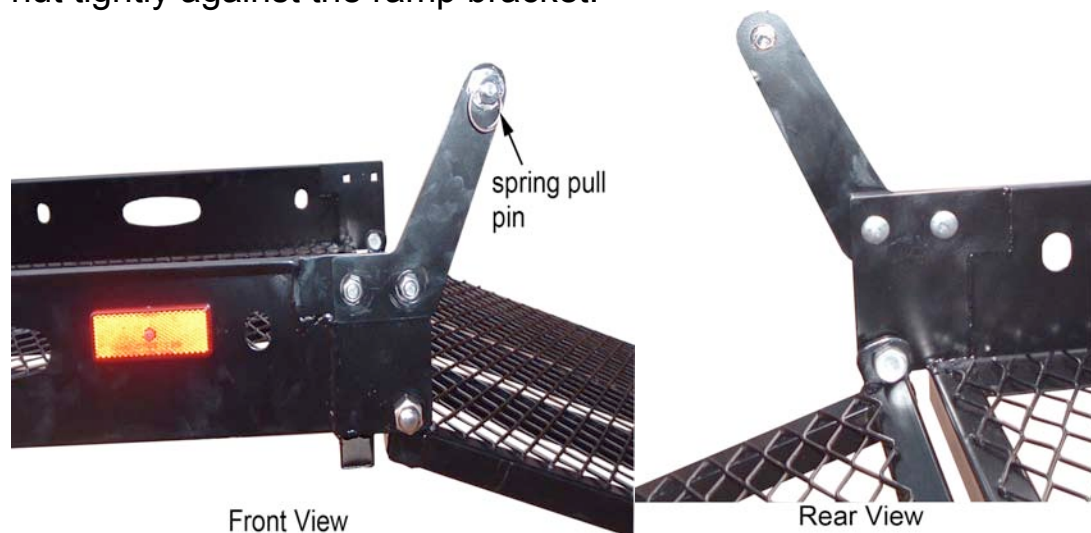

When in use:

Use safety pin to adjust the hitch. See the figure.

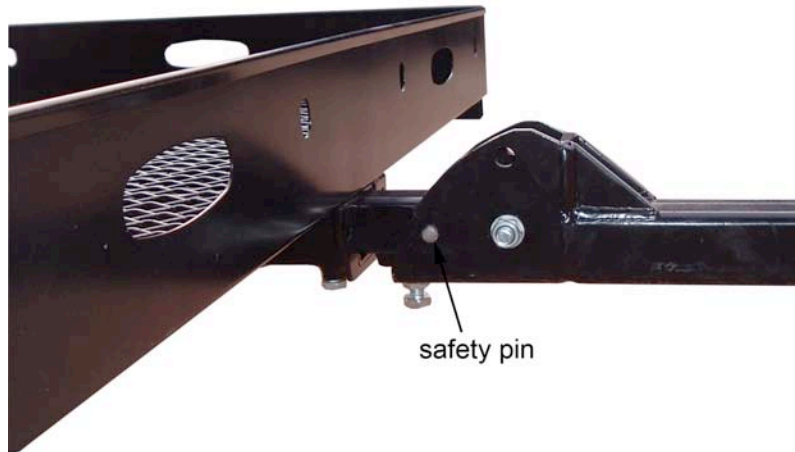

Insert the spring pull pin into the hole on the ramp when you stand the ramp. See the figure.



ATTENTION!

For the first installation of the anti-tilt lock bracket insert the carrier into the hitch receiver. Do not insert the hitch pin at this point. Now slide the carrier toward the vehicle until it holds the anti-tilt lock bracket while an additional person holds the carrier securely against the hitch receiver.

BE SURE TO TORQUE THE BOLTS TO 35-40FT LBS.

Anti-Tilt Locking Device



Underside View

Next loosen the bolts on the anti-tilt lock bracket. (There should be grooves where the bolts were tightened against the hitch receiver)

This procedure is required only during the initial installation of the anti-tilt lock bracket as for the grooves will ensure repeated relocating of the anti-tilt lock bracket. Now pull the carrier out to its final location and install the hitch pin. Return the anti-tilt lock bracket to the location securely against the hitch receiver and torque the bolts.

**THE BOLTS SHOULD FALL INTO THE
GROOVES CREATED EARLIER IN THIS
PROCEDURE.**

ATTENTION:

Large chain loops on trailer hitches will not accept the anti-tilt locking device. In this case you will be unable to use the supplied anti-tilt locking device.

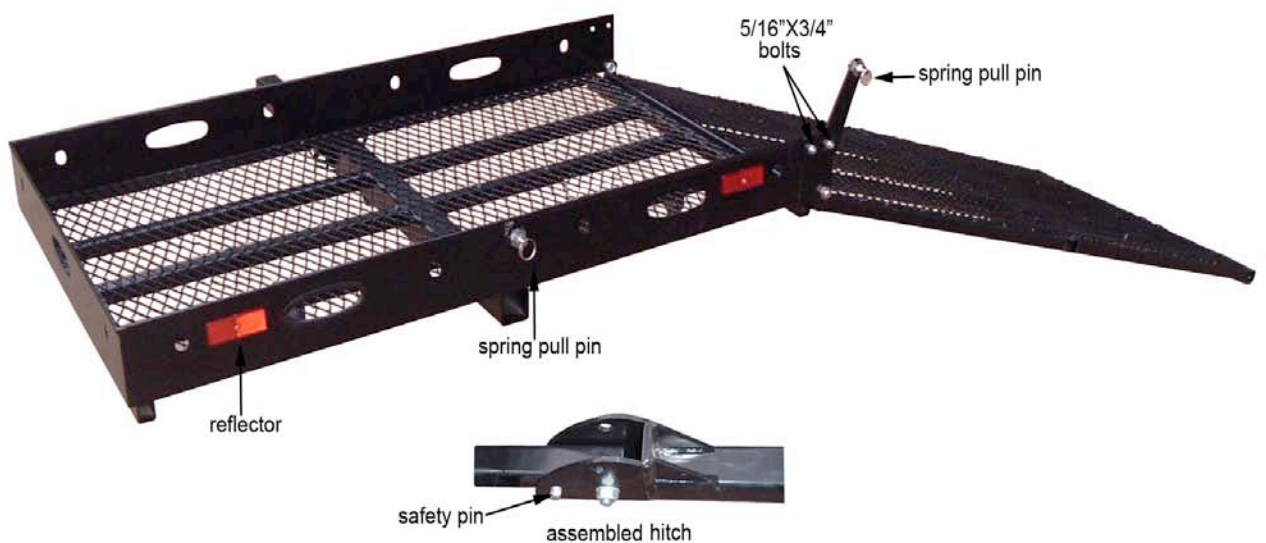

Assembly

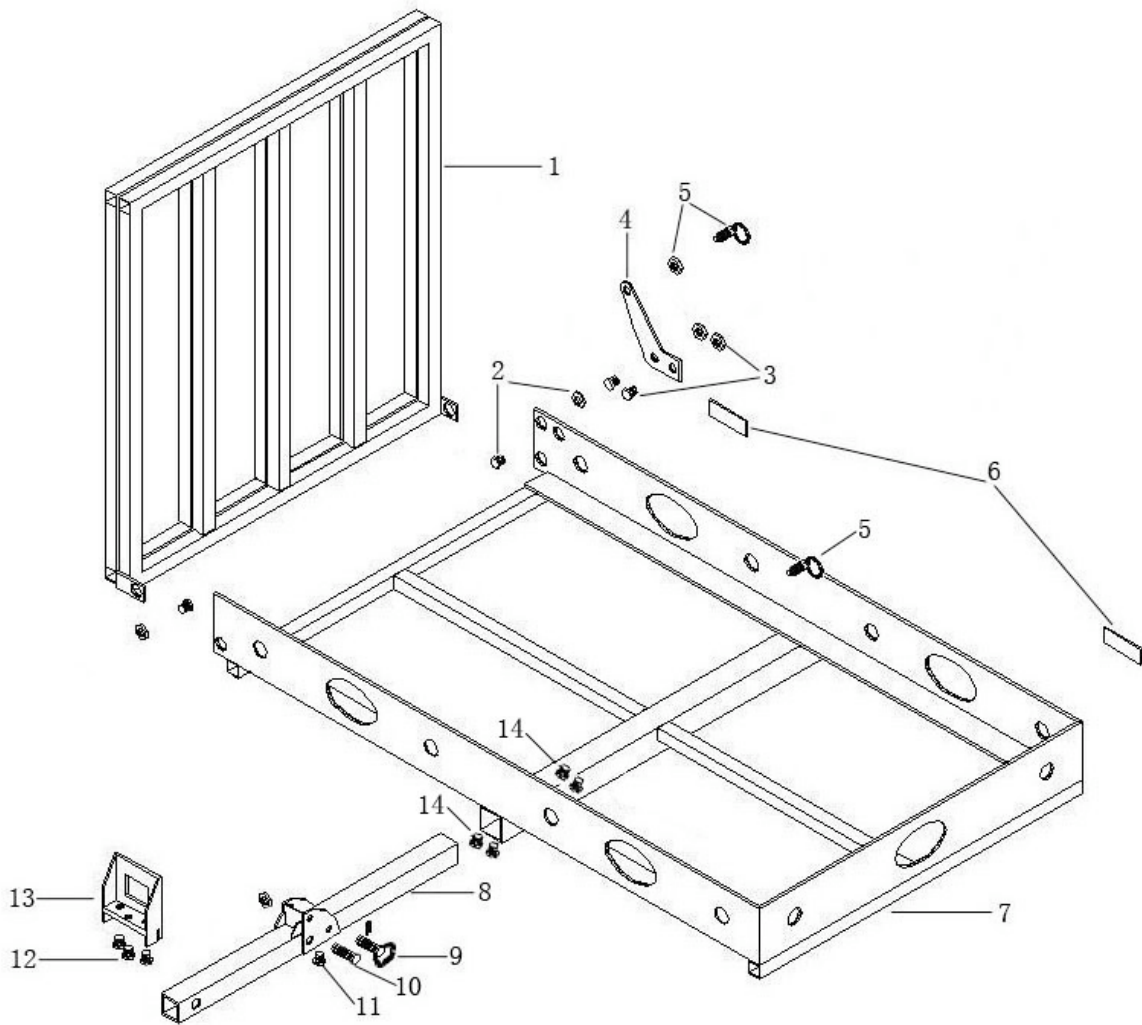

Parts List

Index	Description	Quantity
1	ramp	1
2	ramp bolt sets	2
3	Carriage bolt sets	2
4	Ramp bracket	1
5	Spring pull pin	2
6	reflector	2
7	carrier tray	1
8	gear	1
9	hitch pin	1
10	M12x70 bolt	1
11	adjust bolt	1
12	M10x30 bolt	3
13	anti tilt lock bracket	1
14	lock bolt	4

WARNING

YOU MUST HAND WASH
OR USE A TOUCHLESS
AUTOMATIC CAR WASH
TO PREVENT LIFT DAMAGE.

IF YOU HAVE ANY QUESTIONS REGARDING
WASHING A CAR EQUIPPED WITH A HARMAR
LIFT PLEASE CALL THE HARMAR TECHNICAL
SERVICES DEPARTMENT

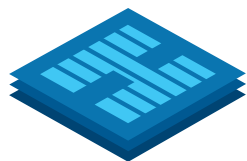

Harmar

MOBILITY MADE EASY

Free Manuals Download Website

<http://myh66.com>

<http://usermanuals.us>

<http://www.somanuals.com>

<http://www.4manuals.cc>

<http://www.manual-lib.com>

<http://www.404manual.com>

<http://www.luxmanual.com>

<http://aubethermostatmanual.com>

Golf course search by state

<http://golfingnear.com>

Email search by domain

<http://emailbydomain.com>

Auto manuals search

<http://auto.somanuals.com>

TV manuals search

<http://tv.somanuals.com>