

NERF™



AGES 6+

N-STRIKE DISK SHOT™

56855

Thank you for purchasing this NERF™ product! Please read these instructions carefully and thoroughly, to ensure proper use and satisfaction with the product.

CAUTION: ELECTRICALLY OPERATED PRODUCT: Not recommended for children under 6 years of age. As with all electric products, precautions should be observed during handling and use to prevent electric shock.

CAUTION: Do not aim at eyes or face.

TO AVOID INJURY: Use only darts and disks designed for this product. Do not modify darts or dart blaster. Do not modify disks or disk launcher.

NOTE: For indoor use only.

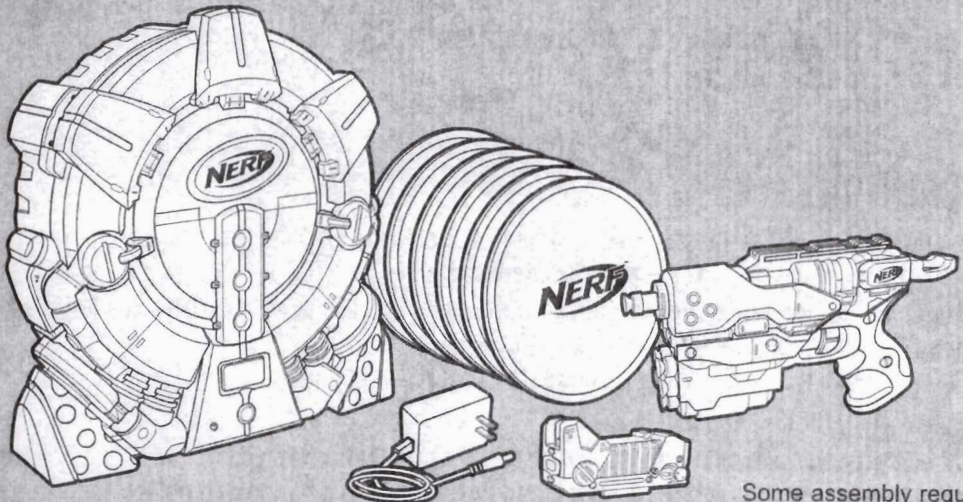

Some assembly required.

After you take the product out of the box, put batteries into the Wireless Remote.

For Wireless Remote:

x2 BATTERIES REQUIRED

1.5V AAA or R03 size
NOT INCLUDED

Alkaline batteries recommended. Phillips/cross head screwdriver (not included) needed to insert batteries.

DC Adaptor Information
Model: BI13-060220-AdU
Adaptor Input: 120 VAC ~ 60Hz 0.35A
Toy Input: 6.0Vdc 2.2A

TO INSERT BATTERIES: (WIRELESS REMOTE)

Use a Phillips/cross head screwdriver (not included) to loosen the screw in the battery compartment cover (screw stays attached to cover). Remove cover. Insert 2 x 1.5V "AAA" or R03 size batteries. Replace cover and tighten screw.

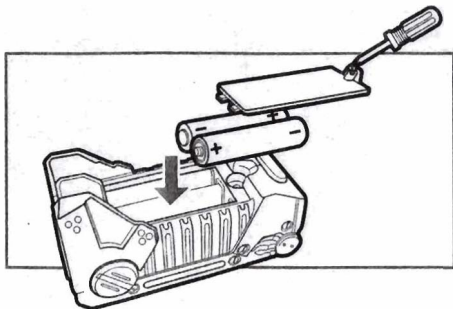

⚠ CAUTION: TO AVOID BATTERY LEAKAGE

- 1. As with all small batteries, the batteries used with this toy should be kept away from small children who still put things in their mouths. If they are swallowed, promptly see a doctor and have the doctor phone (202) 625-3333 collect. In other countries, have the doctor call your local poison control center.**
- 2. Make sure the batteries are inserted correctly and always follow the toy and battery manufacturers' instructions.**
- 3. Do not mix old batteries and new batteries or alkaline, standard (carbon-zinc) or rechargeable (nickel-cadmium) batteries.**
- 4. Always remove weak or dead batteries from the product.**

IMPORTANT: BATTERY INFORMATION

**Please retain this information for future reference.
Batteries should be replaced by an adult.**

⚠ CAUTION:

- 1. Always follow the instructions carefully. Use only batteries specified and be sure to insert item correctly by matching the + and - polarity markings.**
- 2. Do not mix old batteries and new batteries or standard (carbon-zinc) with alkaline batteries.**
- 3. Remove exhausted or dead batteries from the product.**
- 4. Remove batteries if product is not to be played with for a long time.**
- 5. Do not short-circuit the cross terminals.**
- 6. Should this product cause, or be affected by, local electrical interference, move it away from other electrical equipment. Reset (switching off and back on again or removing and re-inserting batteries) if necessary.**
- 7. RECHARGEABLE BATTERIES: Do not mix these with any other types of battery. Always remove from the product before recharging. Recharge batteries under adult supervision. DO NOT RECHARGE OTHER TYPES OF BATTERIES.**
- 8. As with all small items, these batteries should be kept away from children. If swallowed, seek medical attention immediately.**

DISK LAUNCHER

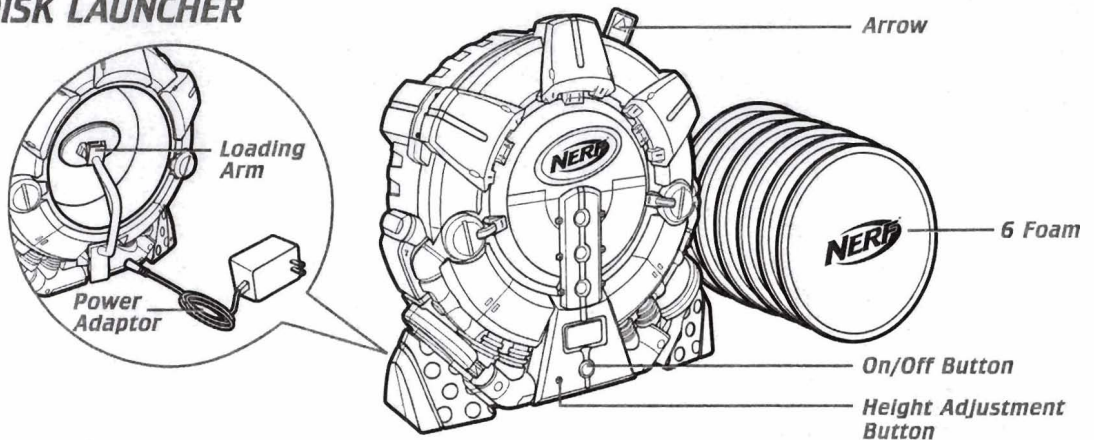

N-STRIKE DISK SHOT™ BLASTER

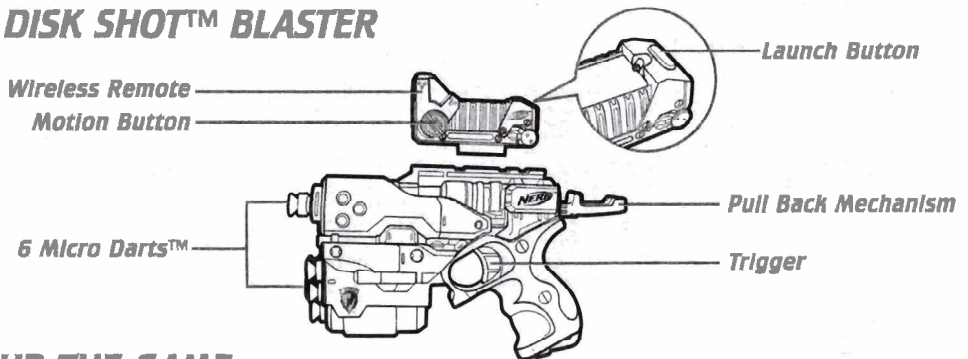

SETTING UP THE GAME

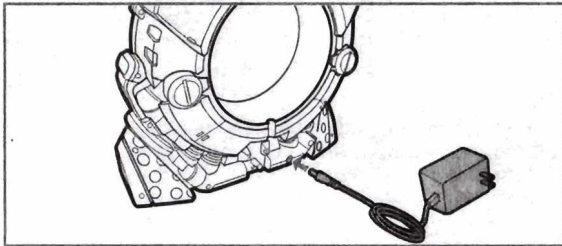

1. Connect the Power Adaptor to the Disk Launcher first, then plug it into an electric outlet.

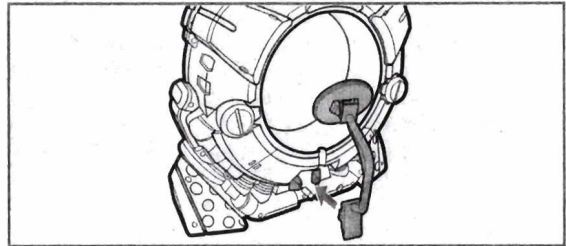

2. Attach the Loading Arm to the back of the Disk Launcher, as shown.

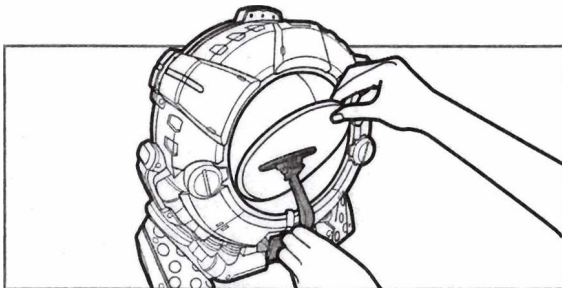

3. Pull back the Loading Arm and insert the Disks, with the black side of Disks facing you. The Disk Launcher can hold a minimum of one Disk or a maximum of 12 disks. (Additional Disks sold separately.)

4. Place the Disk Launcher on a level floor. A Safety Switch on the bottom of the unit will register whether or not the launcher is resting on a level floor. If the Disk Launcher is not resting on a flat surface, the motor will turn off and the Disk Launcher will not function.

NOTE: Do not position the Disk Launcher so that Disks are in danger of hitting windows, furniture, television or stereo equipment, fragile objects, containers of liquid, plants, people, or pets.

WIRELESS REMOTE

The Wireless Remote, which you can attach any N-STRIKE® blaster with a rail system, operates like the remote control to your TV: it sends out an invisible beam, which activates the Disk Launcher.

You must aim the Wireless Remote at the Disk Launcher in order for it to function.

Mount the Wireless Remote onto the blaster rail by sliding and locking it into place.

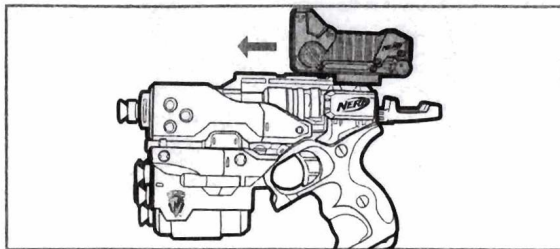

GAME PLAY

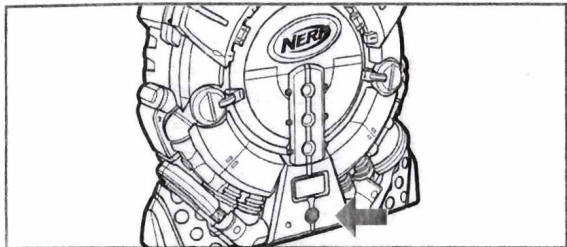

Turn the Disk Launcher ON. The ON switch is located at the bottom front of the Disk Launcher. You will hear a single tone, and the lights on the Launcher will light up.

When you play with this product, it is recommended that you stand at least 8 to 12 feet away from the Disk Launcher.

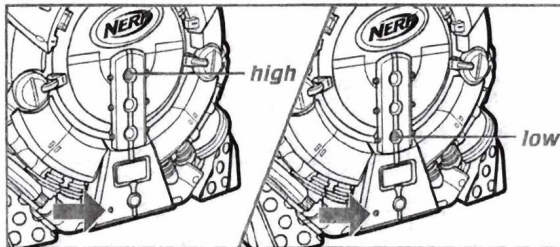

The Disk Launcher has two height settings, to control how high it launches the Disks: the **low** setting is up to 7 feet (2.1 meters); and the **high** setting is up to 9 feet (2.7 meters). The default setting is **low**. Take note of the ceiling height in the room you're playing in, and set the launch height accordingly.

To change the height setting, press the Height Adjustment button on the front of the Disk Launcher. The top light indicates the high setting; the bottom light, the low setting. To return to the default setting, press the button again.

TO LOAD THE BLASTER

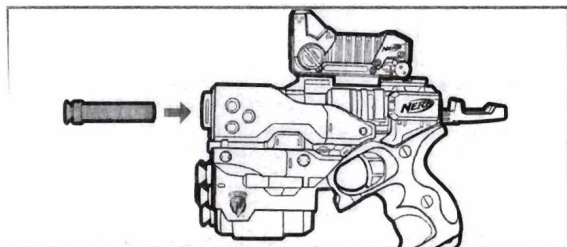

1. Insert a dart into the barrel of the blaster.

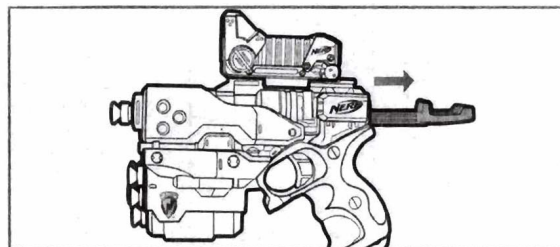

2. Pull back the cocking mechanism.

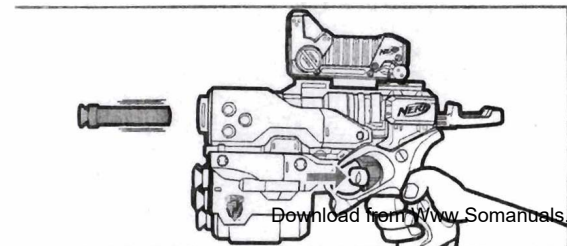

3. Pull the trigger to fire.

4. Repeat steps 1 and 2 with darts from the blaster's storage compartment.

Name

Disks Launched

Total Hits

Brian

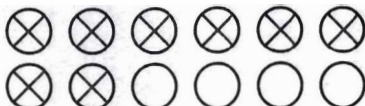

8

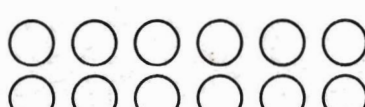
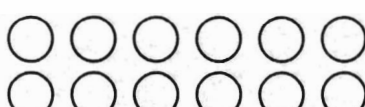

Name

Disks Launched

Total Hits

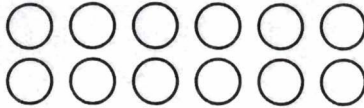

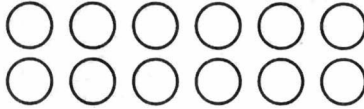

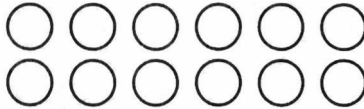

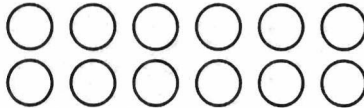

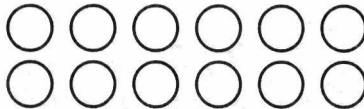

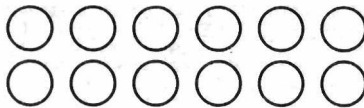

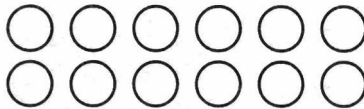

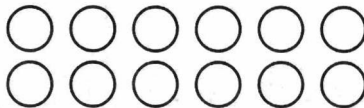

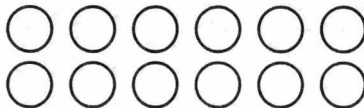

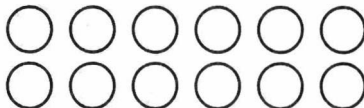

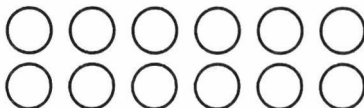

FOR ALL GAMES

1. Aim the blaster at the Disk Launcher.
2. Press the Wireless Remote's Launch button. You will see three red lights go on, on the Disk Launcher.
3. You will hear one long tone, followed by three short tones. This is a countdown to Disk launch. The three red lights will go off, in sequence and in time with each tone, and then a Disk will launch.

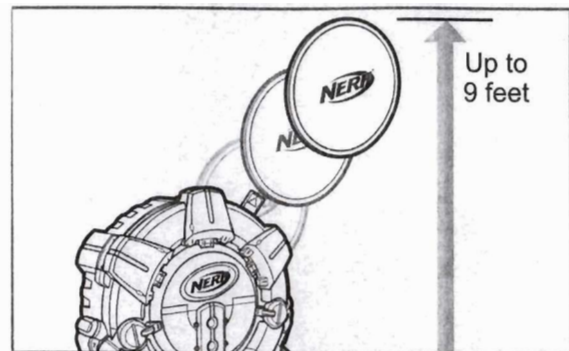

TIP: Keep your arm straight when firing the blaster. As the Disk flies into the air, watch for it to reach its highest point before falling: firing at the Disk at this moment increases the likelihood of hitting your target.

If you do not play with this product for more than approximately three minutes, it will enter "Sleep Mode." Once the unit enters Sleep Mode, you will need to turn the unit off and back on again to start playing again.

HOW TO PLAY

GAME	OBJECTIVE	HOW TO PLAY
1. FIXED FIRE	Hit as many Disks as possible as they fly in a fixed trajectory.	<ol style="list-style-type: none"> 1. Aim the blaster at the Disk Launcher and press the Wireless Remote's Launch button. LED lights will signal and initiate the launch sequence: you will hear one long tone, followed by three short tones, and then the first Disk will launch. 2. Aim your blaster, fire, and try to hit the Disk with a dart. Hitting the Disk at any time before it touches the ground counts as a hit. 3. Reload your blaster. To launch another Disk, aim your blaster at the Disk Launcher and press the Wireless Remote's Launch button again. 4. Repeat until all Disks are emptied from Disk Launcher. After the last Disk has launched, the unit's motor will wind down. You may reload Disks, collect darts, and return to step one.
2. MIX IT UP	Hit as many Disks as possible as they fly out in different trajectories.	<ol style="list-style-type: none"> 1. Manually push the spring-loaded Arrow on the Disk Launcher to make it pop up. 2. Aim the blaster at the Disk Launcher and press the Wireless Remote's Motion button. You need only press the Motion button once. 3. Then press the Wireless Remote's Launch button. LED lights will signal and initiate the launch sequence: you will hear one long tone, followed by three short tones, and then the first Disk will launch. 4. Watch where the arrow is pointing: this is the direction the Disk will fly. 5. Aim your blaster, fire, and try to hit the Disk with a dart. Hitting the Disk at any time before it touches the ground counts as a hit. To launch another Disk, aim your blaster at the Disk Launcher and press the Wireless Remote's Launch button again. 6. Repeat until all Disks are emptied from the Disk Launcher. After the last Disk has launched, the Unit's motor will wind down. You may reload Disks into launcher, collect darts, and return to step one.
3. MYSTERY SHOT	Hit as many Disks as possible as they fly out in different trajectories, which you will not see beforehand.	<ol style="list-style-type: none"> 1. Gently push down on the arrow until it clicks into the unit and you cannot see it. 2. Aim the blaster at the Disk Launcher and press the Wireless Remote's Motion button. You need only press the Motion button once. 3. Then press the Wireless Remote's Launch button. LEDs will signal and initiate the launch sequence: you will hear one long tone, followed by three short tones, and then the first Disk will launch. You will not know the direction of the Disk until it launches. 4. Aim your blaster, fire, and try to hit the Disk with a dart. Hitting the Disk at any time before it touches the ground counts as a hit. To launch another Disk, you need to aim your blaster at the Disk Launcher and press the Wireless Remote's Launch button again. 5. Repeat until all Disks are emptied from the launcher. After the last Disk has launched, the Unit's motor will wind down. You may reload Disks, collect darts, and return to step one.

NOTE: If, after playing games 2 and 3, you wish to play game 1, push the Motion Button when the Arrow is back at the center.

OTHER GAMES

Feel free to make up your own games, as you play with this product!

For example, if you are playing with a friend, you could launch six Disks and play "Best of Six": whoever hits the most Disks wins.

If your friend has his or her own N-STRIKE® blaster (sold separately), one player could launch the Disks with a Wireless Remote and both players could try to hit them at the same time.

TIPS

This product is for **indoor use only**. Do not take the Disk Launcher outdoors or expose it to natural elements such as wind, rain, or snow. Play in a clear, open indoor area.

Do not use the Disk Launcher or play this game with anything other than N-STRIKE® blasters.

TROUBLESHOOTING

I'm pressing the Wireless Remote buttons and nothing is happening with the Disk Launcher.	<ul style="list-style-type: none">- Make sure, when you are pressing the buttons on the Wireless Remote, that you are aiming the Wireless Remote at the Disk Launcher.- The unit may be in Sleep Mode: turn it off and back on.- Make sure you have fresh batteries in the Wireless Remote and that the Disk Launcher is plugged into a working electrical outlet.
One of the Disks appears to be stuck.	<ul style="list-style-type: none">- Unplug the Disk Launcher and attempt to dislodge the stuck Disk.
The three (3) LED lights on the unit are flashing.	<ul style="list-style-type: none">- There are no Disks in the unit, or the Loading Arm is not attached.
A tone is repeating and will not stop.	<ul style="list-style-type: none">- There is an error with the unit. Turn it off and unplug it. Check to make sure there are no Disks stuck in the unit. Turn the unit back on again.

FCC STATEMENT

This device complies with part 15 of the FCC Rules. Operation is subject to the following two conditions: (1) This device may not cause harmful interference, and (2) this device must accept any interference received, including interference that may cause undesired operation.

Warning: Changes or modifications to this unit not expressly approved by the party responsible for compliance could void the user's authority to operate the equipment.

This equipment has been tested and found to comply with the limits for a Class B digital device, pursuant to part 15 of the FCC Rules. These limits are designed to provide reasonable protection against harmful interference in a residential installation. This equipment generates, uses and can radiate radio frequency energy, and, if not installed and used in accordance with the instructions, may cause harmful interference to radio communications. However, there is no guarantee that interference will not occur in a particular installation. If this equipment does cause harmful interference to radio or television reception, which can be determined by turning the equipment off and on, the user is encouraged to try to correct the interference by one or more of the following measures:

- Reorient or relocate the receiving antenna.
- Increase the separation between the equipment and the receiver.
- Consult the dealer or an experienced radio/TV technician for help.
- Connect the equipment into an outlet on a circuit different from that to which the receiver is connected.

Connect the equipment into an outlet on a circuit different from that to which the receiver is connected.

Your Disk Shot and DC adaptor should be periodically examined for potential hazards. If any potential hazards are found, please contact Hasbro Consumer affairs at 1-800-844-3733 for repair or replacement.



© 2007 Hasbro. All Rights Reserved.

TM & ® denote U.S. Trademarks.

U.S. Pat. Nos. 5611322, 5471967 and 5529050.

56855

P/N 667970000

Product and colors may vary.



Questions? Call: 1-800-327-8264

Free Manuals Download Website

<http://myh66.com>

<http://usermanuals.us>

<http://www.somanuals.com>

<http://www.4manuals.cc>

<http://www.manual-lib.com>

<http://www.404manual.com>

<http://www.luxmanual.com>

<http://aubethermostatmanual.com>

Golf course search by state

<http://golfingnear.com>

Email search by domain

<http://emailbydomain.com>

Auto manuals search

<http://auto.somanuals.com>

TV manuals search

<http://tv.somanuals.com>