

Disney's THE HUNCHBACK OF NOTRE DAME

INSTRUCTIONS

2 to 4 Players

Figure 1. 4-Player Game Set Up for Play

Figure 1A. Street Scenes

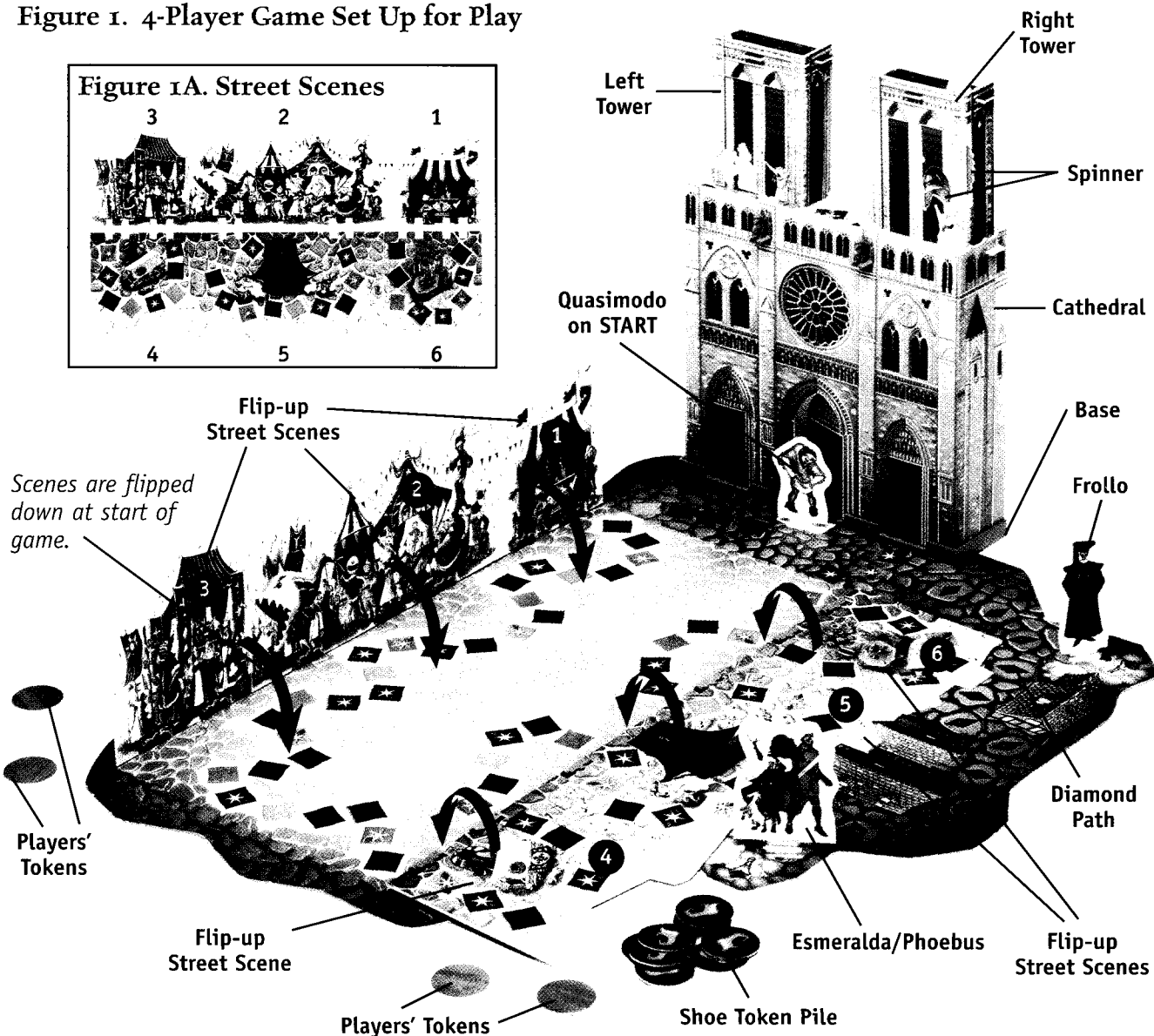
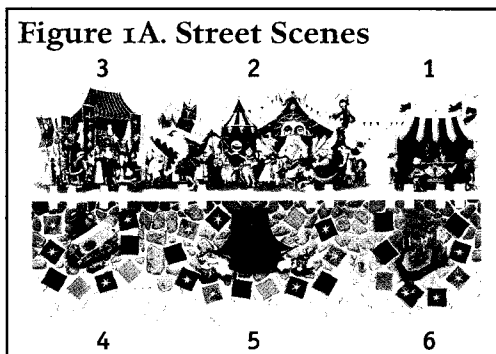

CONTENTS: 3-D Flip-up Gameboard with 6 Cardboard Street Scenes, Cardboard Cathedral with Spinner, 14 Tokens, 3 Pawns with Pawn Stands, 6 Plastic Plain Clips and 6 Fin Clips with 12 Bases, 2 Plastic Gargoyle Brackets with 2 U-Shapes, Plastic Slider, Cathedral Base and Button.

GAME ASSEMBLY

Figure 1 shows a game set up for 4 players. Refer to it as you assemble the game. Carefully punch out all cardboard and plastic parts as needed. Be sure to punch out all slots and holes in the cardboard parts and gameboard.

Assemble the Cathedral

Cardboard Parts Needed: Cathedral Front, Roof and Floor; Right and Left Tower with Roofs; Spinner.

Plastic Parts Needed: 2 Gargoyle Brackets, 2 U-Shapes, Slider, Cathedral Base, Button.
(Carefully remove the plastic parts from the inside of the Cathedral Base. Discard any extra plastic.)

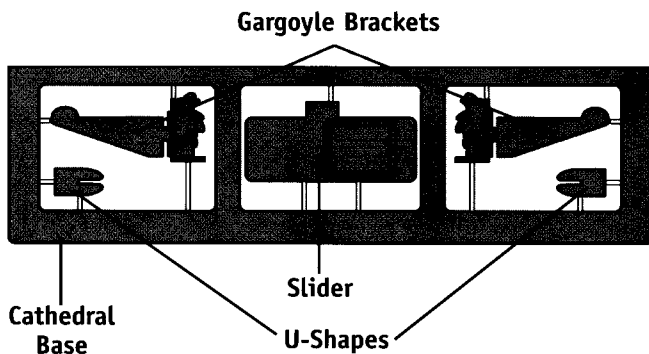

1. Fold the Cathedral Front and insert the 2 Gargoyle Brackets. See Figure 2. Then slide a U-Shape onto the back of each Gargoyle Bracket as shown in Figure 2A.

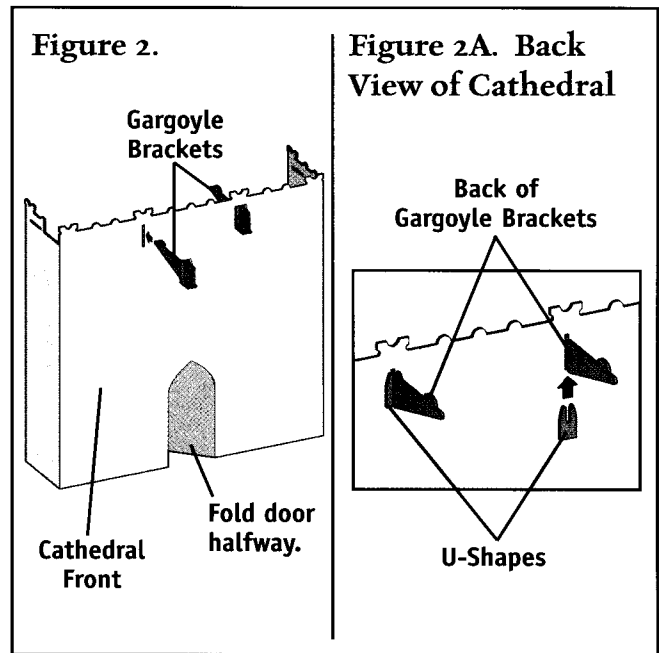

2. Now lay the cardboard Roof on top of the Gargoyle Brackets' plastic tabs and press the plastic tabs through the Roof's slots A and B. Then slide the Roof's tabs into the Cathedral's side slots. See Figure 3.

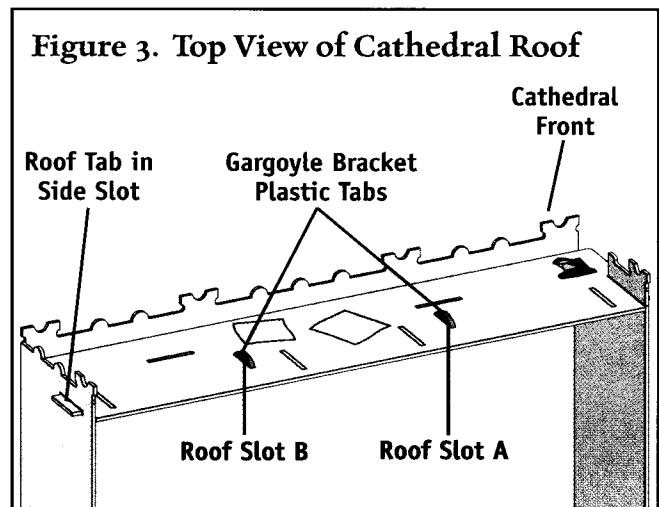

3. Fold the Right Tower. Insert the Spinner into the Tower's side slot and attach it with the button as shown in Figures 4 and 4A. Then attach a Tower Roof (shown assembled in Figure 5). Insert the Tower into the Cathedral Roof slots. See Figure 5.

Figure 4. Back View of Right Tower

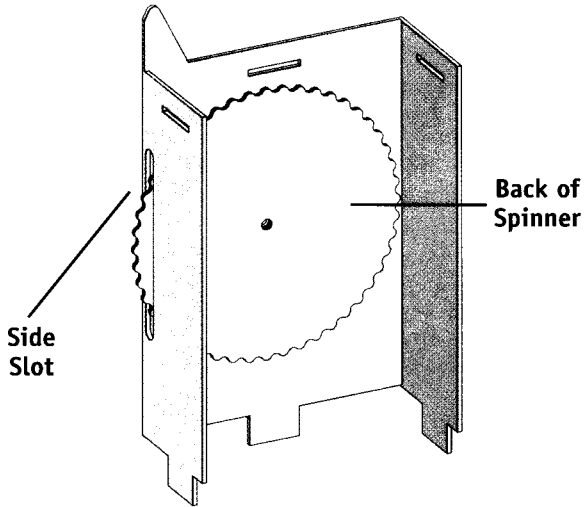
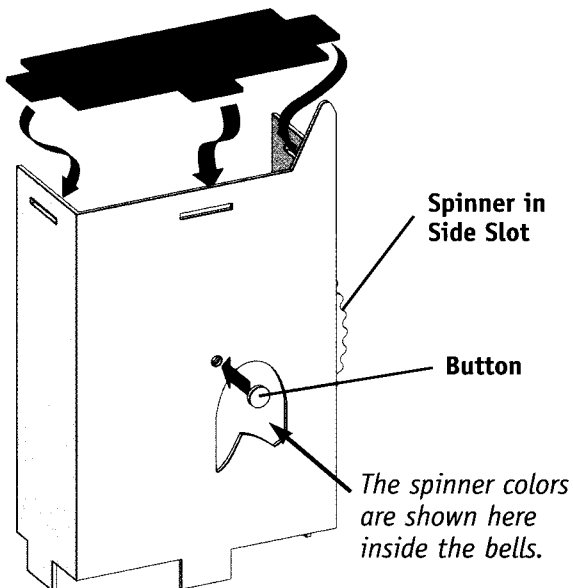
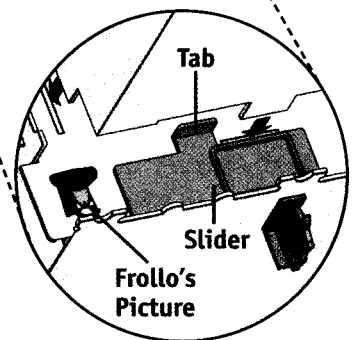
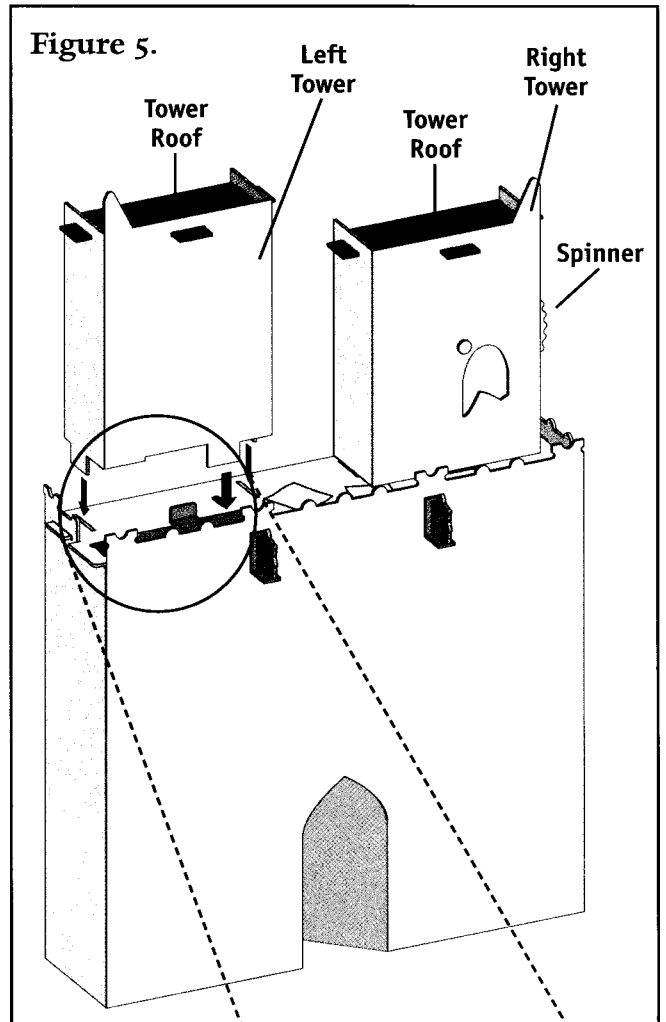

Figure 4A. Front View of Right Tower



4. Fold the Left Tower and attach a Tower Roof. Place the Slider on the Cathedral Roof and attach the Tower so it goes over the Slider's upright tab as shown in Figure 5.

Figure 5.



5. Insert the Cathedral Floor into the plastic Base over its middle pegs. Then attach the Cathedral to the Base. See Figures 6 and 6A.

Figure 6.

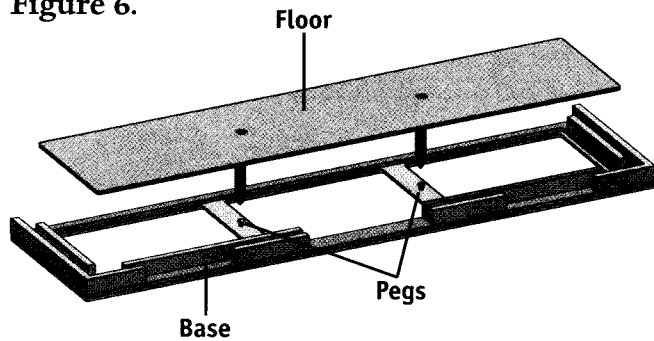
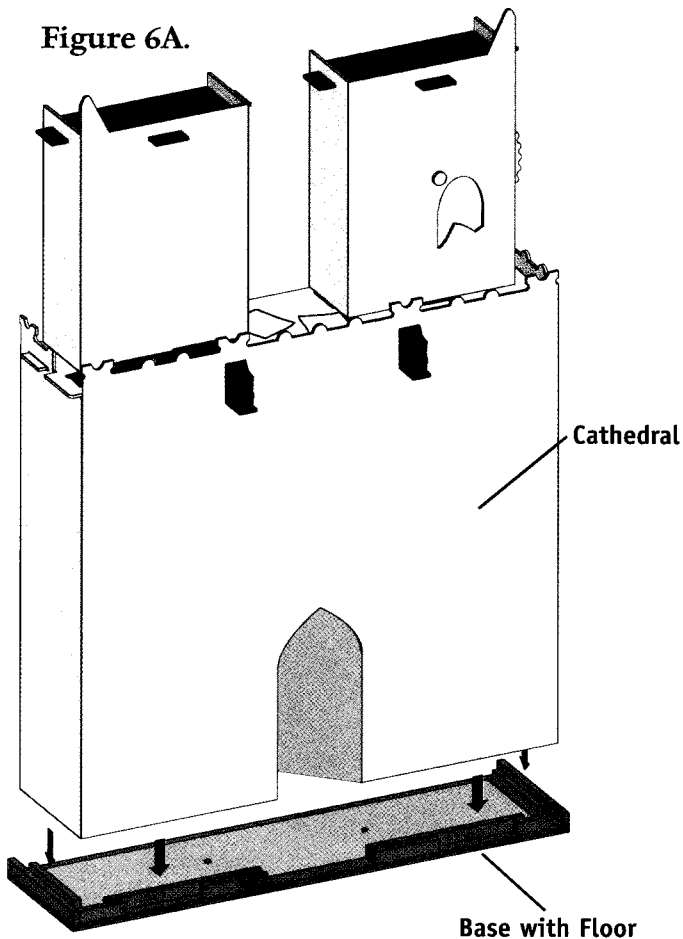

Figure 6A.



Assemble the Street Scenes

Cardboard Parts Needed: 6 Street Scenes.

Plastic Parts Needed: 6 Plain Clips, 6 Fin Clips, 12 Bases. (Carefully remove the clips and bases from the runners and discard waste.)

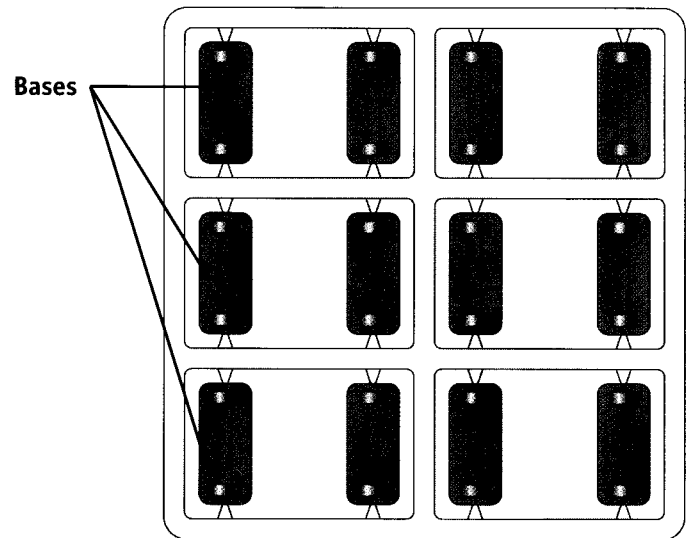
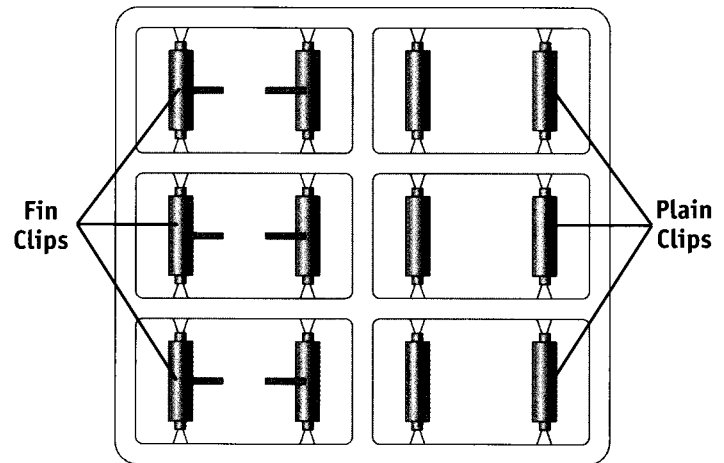

1. Insert all 12 Bases up into the gameboard slots from underneath the gameboard. Then attach 6 Fin Clips and 6 Plain Clips as shown in Figure 7.

Figure 7.

Attach **Fin Clips** to Bases on gameboard's **left side**.

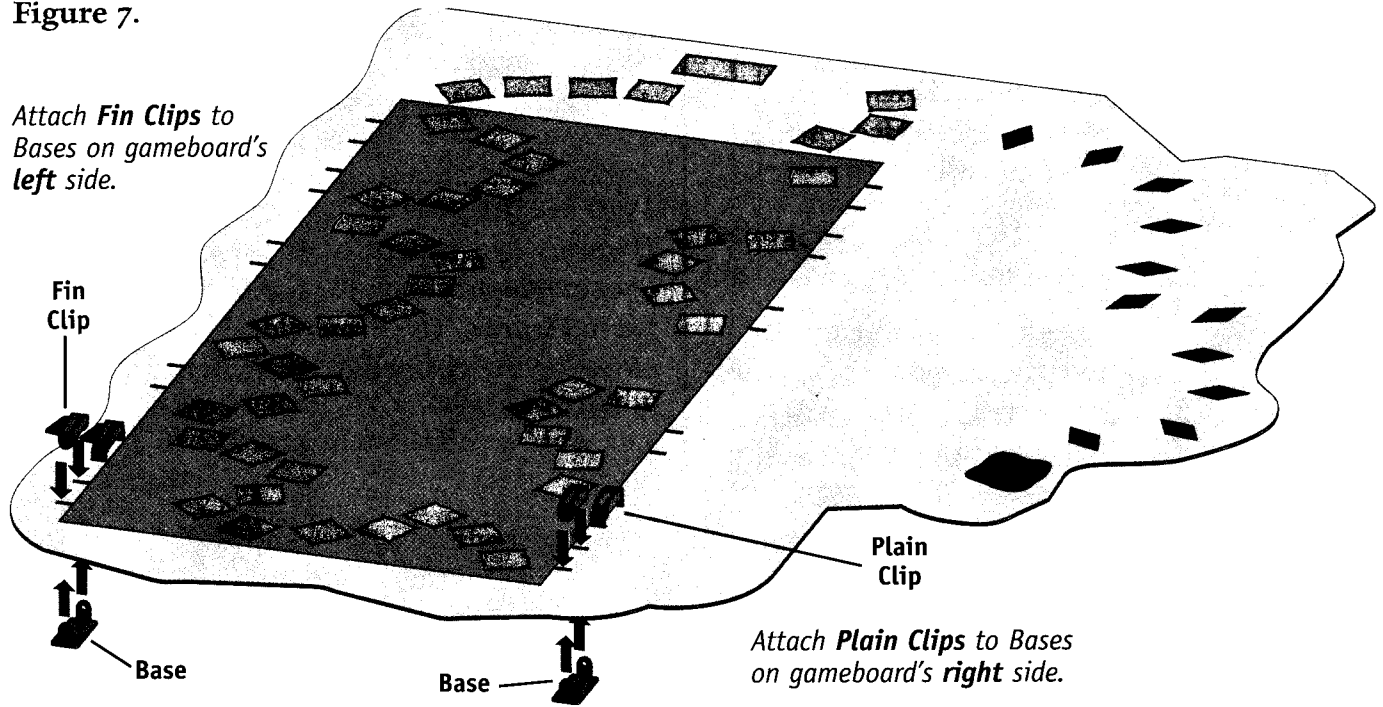

2. Now slide all Street Scenes down as far as they will go into the clips. See Figure 8.
(See Figure 1 for correct scene placement.)

Figure 8.

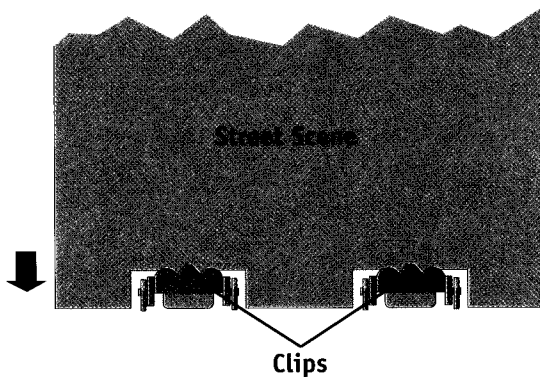

SETUP

Refer to Figure 1 when setting up the gameboard.

1. Flip down all Street Scenes so they are cobblestone-side up. Then insert the Cathedral Base's bottom pegs into the two holes at the gameboard's end.
2. Slide the Slider on the Cathedral to the right (towards the Spinner) as far as it will go.
3. Insert the three pawns into their pawn stands. Place Frolo and Esmeralda/Phoebus on their matching spaces on the gameboard. Place Quasimodo on START.



Shoe Token

4. **Choose Your Token:** In a 2-Player and 4-Player game, put 3 Shoe tokens and 1 Crown token facedown. Mix them up.

(In a 3-Player game, use 2 Shoe tokens and 1 Crown token.)

Players then select a token from the mixed-up pile, look at it secretly and place it facedown in front of themselves. Tokens stay facedown throughout the game.



Crown Token

(In a 2-Player game, each player picks two tokens.)

Place the extra Crown token out of play. Set all other Shoe tokens faceup in a pile nearby.

HOW TO PLAY

Object: Whoever has the Crown token when the game is over wins.

Two Gamepaths

There are two gamepaths on the gameboard. Quasimodo moves on the flip-up path shown in red in Figure 9. The Esmeralda/Phoebus pawn moves on the Diamond Path shown in yellow in Figure 9.

Figure 9. The Gameboard

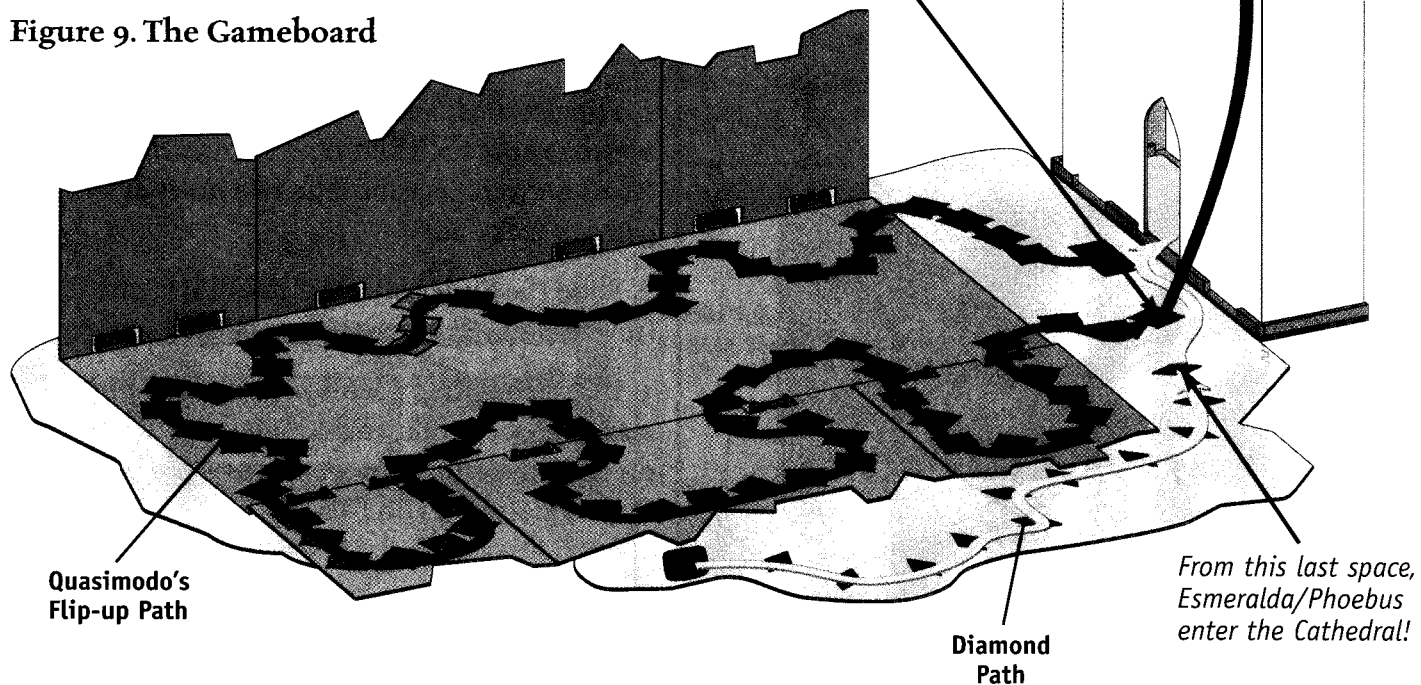

From here, Quasimodo climbs to the Cathedral's rooftop!

From this last space, Esmeralda/Phoebus enter the Cathedral!

Who Goes First?

If you have the Crown token, announce that you have it and take the first turn. Play continues to the left.

On Your Turn

1. Spin the spinner. Check the color inside the bell.
2. Move the Quasimodo pawn to the next matching color space. You may have to flip up a Street Scene to move there. More about that later.
3. Follow the directions for the space you land on. See *The Spaces* below.

The Tokens

During the game, players will be picking tokens from the pile and each other. If you pick the Crown token from another player, you must announce it immediately and show it to everyone. Then put it facedown with your other tokens and mix them up to hide it!

The Spaces



When you land on a Color space, stop Quasimodo there. If the Color space has a star and one or two diamonds on it, do the following. A **Star** means that you can now pick any token from any player. (Try to get the Crown token if you can!) One or two **Diamonds** mean that you can now move Esmeralda/Phoebus ahead on the Diamond Path toward the Cathedral. Move one space for one diamond; two spaces for two diamonds. Then your turn is over.

IMPORTANT! If Esmeralda/Phoebus land on the **last space** on the Diamond Path (see Figure 9 for location), immediately open the Cathedral's door and move them inside the Cathedral. As a reward for your help, now take another turn!

Special Striped Spaces: There are 4 Special Striped spaces. (Two are on the gameboard and two are on top of the Cathedral.) You **cannot** pass these spaces. No matter what color you spin, you must stop Quasimodo here. Each space has a star on it so when you land on one, immediately pick any token from any player.

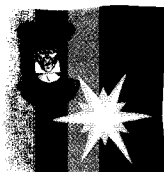

If **Frolo** is also on it, move Frolo onto his matching picture on the Cathedral's Roof. Your turn is then over.

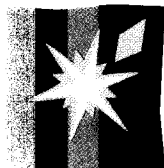

OR if a **Diamond** is also on it, immediately move Esmeralda/Phoebus into the Cathedral. As a reward for your help, now take another turn! (If they are already inside, you do **not** take another turn.) Your turn is then over.

How to Flip Up a Street Scene

If Quasimodo does not have any more matching color spaces visible on the gameboard just ahead of him, flip up the closest Street Scene and move him ahead to the next matching color space revealed. See Figure 10. **When you flip up a Street Scene, take a Shoe token from the pile.** Put it facedown with your other token(s).

Note: The Street Scenes on the left stand up against the Fin Clips. The Street Scenes on the right lie flat.

Figure 10. How to Flip Up a Street Scene

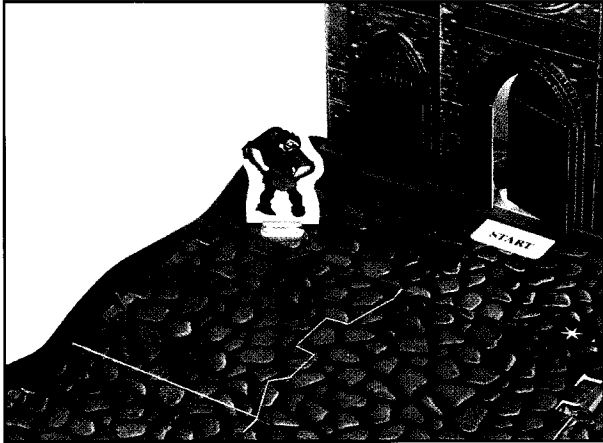

You spun purple. Flip up the Street Scene and move Quasimodo to the next Purple space!

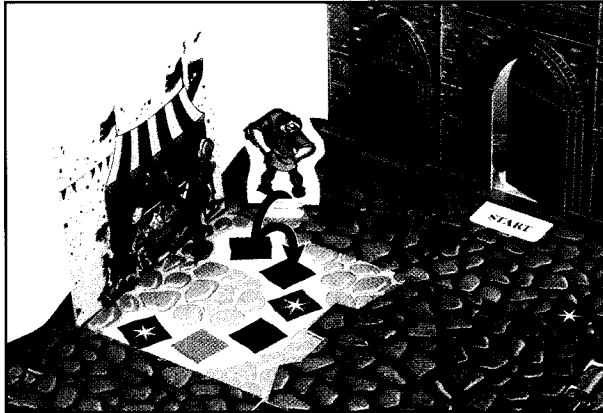

Since you flipped up a Street Scene, you collect a Shoe Token from the pile, too!

HOW TO WIN

When a player moves Quasimodo to the last space on top of the Cathedral, he or she has one last chance to try to pick the Crown token. Whoever then has the Crown token is the winner!

Now Battle Frollo! The winner now places Quasimodo on the Slider and slides him to the left, tumbling Frollo off the roof! See Figure 11. Then move Quasimodo down to the town square and bring out Esmeralda/Phoebus to help celebrate their freedom from Frollo! Everyone is saved!

Figure 11.

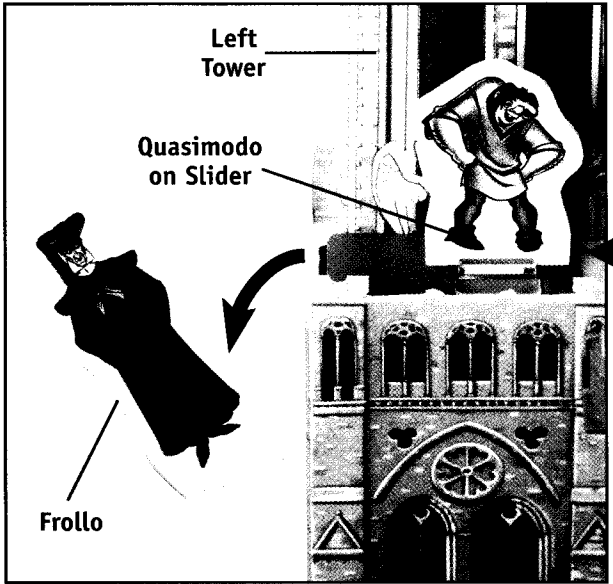

You won! Push the Slider and help Quasimodo make Frollo tumble off the roof!

Note: When you've finished playing, fold the gameboard up, leaving the Street Scenes flat in place. Place the gameboard and pawns in the box with the assembled Cathedral on top. (Don't press the lid down or you'll crush the Cathedral.)

Milton Bradley Company
 P.O. Box 1247
 East Longmeadow, MA 01028

© Disney
 © Milton Bradley Company.
 All Rights Reserved. 4637-I

WARNING:
 CHOKING HAZARD-Small parts.
 Not for children under 3 years.

Free Manuals Download Website

<http://myh66.com>

<http://usermanuals.us>

<http://www.somanuals.com>

<http://www.4manuals.cc>

<http://www.manual-lib.com>

<http://www.404manual.com>

<http://www.luxmanual.com>

<http://aubethermostatmanual.com>

Golf course search by state

<http://golfingnear.com>

Email search by domain

<http://emailbydomain.com>

Auto manuals search

<http://auto.somanuals.com>

TV manuals search

<http://tv.somanuals.com>