

# NERF®

PLAY YOUR GAME™

AGES 6+  
45519



## Cyclotron™

Thank you for purchasing the NERF ATOM BLASTERS CYCLOTRON, the biggest and baddest NERF ball blaster EVER!

The NERF ATOM BLASTERS CYCLOTRON Blaster is the biggest and baddest way to blast out a bunch of balls! Load up to 6 NERF balls at a time and get crankin'! The faster YOU crank – the faster and further you can blast out NERF balls!

 **CAUTION:** Do not aim at eyes or face.

**TO AVOID INJURY:** Use only balls designed for this product. Do not modify balls or ball launcher.

### TO ASSEMBLE CRANK

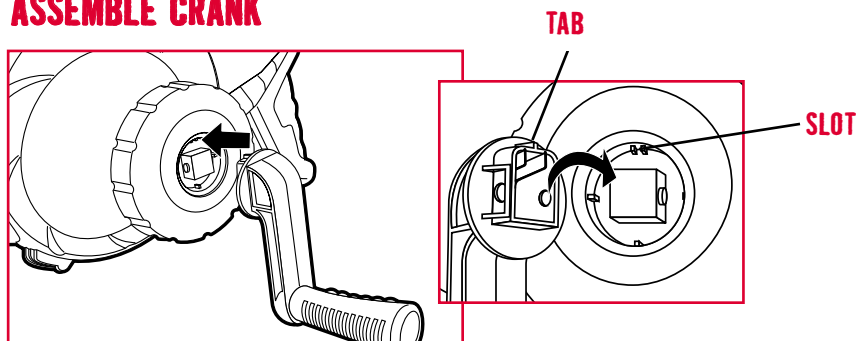

Align tab on crank with slot on crank base. Snap crank into base firmly.

**Note:** This is a one-time assembly.

## TO USE

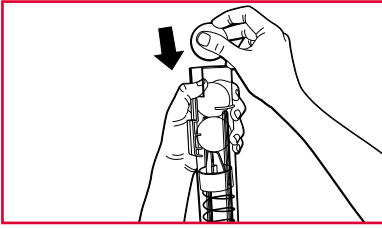

Load "Ball Tube" one at a time, with 6 NERF balls (included).

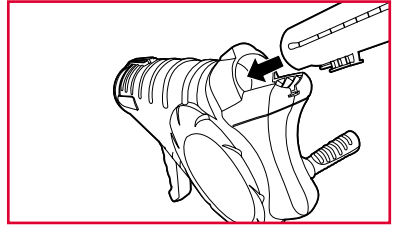

Slide "Ball Tube" into the CYCLOTRON Blaster.

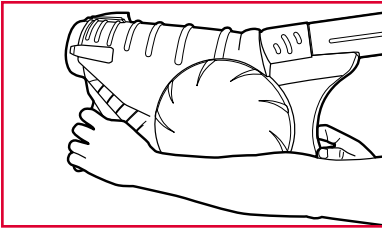

Hold front handle of CYCLOTRON with left hand.

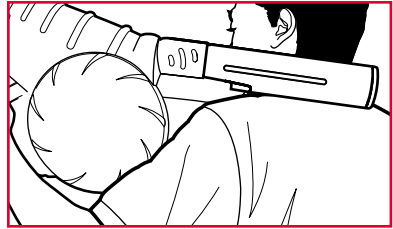

Use shoulder rest for easy use and balance.

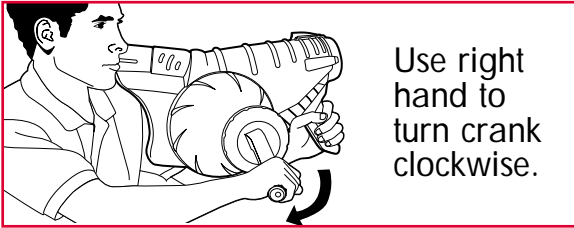

Use right hand to turn crank clockwise.

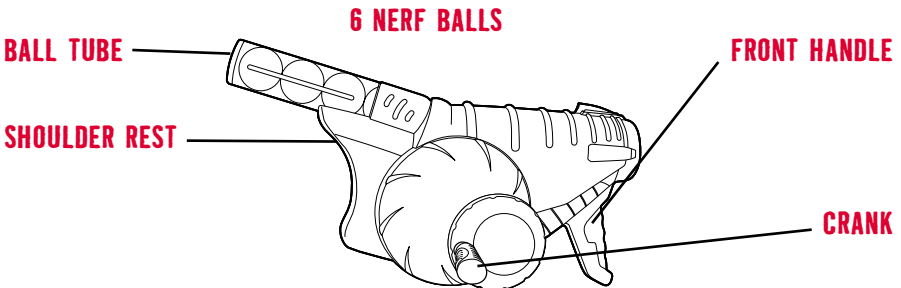

© 2003 Hasbro. All Rights Reserved.  
® denotes Reg. U.S. Pat. & TM Office.  
45519 P/N 6269470000

Download from [www.Somanuals.com](http://www.Somanuals.com). All Manuals Search And Download.



Questions? Call: 1-800-327-8264

## Free Manuals Download Website

<http://myh66.com>

<http://usermanuals.us>

<http://www.somanuals.com>

<http://www.4manuals.cc>

<http://www.manual-lib.com>

<http://www.404manual.com>

<http://www.luxmanual.com>

<http://aubethermostatmanual.com>

Golf course search by state

<http://golfingnear.com>

Email search by domain

<http://emailbydomain.com>

Auto manuals search

<http://auto.somanuals.com>

TV manuals search

<http://tv.somanuals.com>