

*H A S S E L B L A D*

**USER MANUAL (V1)**

***H1D***



## C O N T E N T S

<b>Introduction</b>	<b>4</b>	<b>Quick Start Guide</b>	<b>13</b>	<b>Viewfinder</b>	<b>75</b>
<b>1. Quick Start Guide</b>	<b>13</b>	<b>Function Control &amp; Display</b>	<b>21</b>	Parts & Components	77
<b>2. Function Control &amp; Display</b>	<b>21</b>	<b>Sensor unit &amp; Image Bank</b>	<b>41</b>	Attaching and removing the viewfinder	77
<b>3. Camera Body</b>	<b>69</b>	Control panel	44	Eyepiece adjustment	78
<b>4. Viewfinder</b>	<b>75</b>	Zooming	47	<b>Lenses</b>	<b>79</b>
<b>5. Lenses</b>	<b>79</b>	Browse options	48	Parts & Components	80
<b>6. Film Magazines</b>	<b>85</b>	Deleting images	49	Attaching a lens	80
<b>7. Light Metering</b>		Changing settings	51	Removing a lens	81
<b>&amp; Exposure Control</b>	<b>99</b>	Error messages	55	Lens cap	81
<b>8. General Functions</b>	<b>111</b>	Image Bank	56	Filters and accessories	81
<b>9. Advanced Features</b>	<b>123</b>	Battery	58	Lens shades	81
<b>10. Flash</b>	<b>151</b>	Transferring images	59	Shutter and aperture control	82
<b>11. Optional Accessories</b>	<b>157</b>	Contents window	60	Depth-of-field calculation	82
<b>12. Appendix</b>	<b>163</b>	Image transfer options	63	Depth-of-field / visual preview	83
		Care and maintenance	65	Infrared focus settings	83
		<b>Camera Body</b>	<b>69</b>	Focusing aid	83
		Carrying strap	71	<b>Film Magazines</b>	<b>85</b>
		Batteries	71	Parts & Components	86
		Viewfinder screen	72	LCD panel	87
		Accessory connection	73	LCD illumination button	87
		PC-connector	73		

Change up button	87	<b>Light Metering &amp; Exposure Control</b>	<b>99</b>	Profiles	120
Change down button	88	Metering method	102	Making a profile	121
Function selector	88	Exposure method	103	Changing a profile name	122
Film plane index	88	Manual exposure mode	104	<b>Advanced Features</b>	<b>123</b>
Darkslice indicator	88	Automatic exposure mode	105	Self Timer	124
Darkslice key	89	AE- L button	106	Bracketing	128
Film tab holder	89	Exposure compensation	109	Interval	131
Film holder key	89	<b>General Functions</b>	<b>111</b>	Settings	133
Magazine settings lock	89	Power - ON	112	Custom Options	136
Databus interface	89	Power - Standby	112	Digital	142
Magazine operation	90	Power - OFF	113	User Button	144
Battery	90	Manual focus	113	Imprinting	146
Battery replacement	90	Manual focus mode	114	<b>Flash</b>	<b>151</b>
Attaching and removing the magazine	91	Manual override	114	Integral flash	154
Magazine settings	92	Autofocus	115	Flash measure	156
Film speed setting	92	Single Shot	115	<b>Optional Accessories</b>	<b>157</b>
Film speed setting / Barcode	92	Continuous	117	<b>Appendix</b>	<b>163</b>
Film length/number of frames	93	Autofocus mode	117	Glossary	164
Data imprint setting	94	Drive	118	Technical specifications	173
Frame counter setting	94	Single	118	Equipment care, service and guarantee	181
Low-battery symbol	95	Continuous	118		
Film loading	96	Multi exposure	119		
Film wind off	98				



## **Congratulations!**

*You have in your possession the result of the most intensive technical development programme ever undertaken by Hasselblad, the most prestigious medium-format camera manufacturer in the world. It reflects an unprecedented wealth of knowledge and experience tightly interwoven with the latest technological developments that combined to produce an unrivalled world-class creative tool for the discerning photographer.*

*Hasselblad had its beginnings during the last fifty years of the last millennium. Within twenty years it was present as mankind took the first small step on the moon. Hasselblad continues its journey into the future exploiting the latest in developments to create a completely digital medium-format camera. It produces the utmost in image-quality, handling and versatility resulting from the most reliable and efficient solutions to meet photographers' expectations.*

*The H1D camera system presents a list of features coloured by superlatives. What was once considered optional is now integral. The potential of this outstanding professional equipment straight out of the box is dazzling.*

*But there is no trade-off in quality for the sake of trend technology. The three pillars of the Hasselblad reputation remain: Reliability, Versatility, Interchangeability. Stainless*

steel and aluminium for no-nonsense professional use and durability. Silicon chip control for basic practical support as well as sophisticated facilities to span all demands. A digital capture facility that is in the forefront to easily match the demands of most professional photographers working in the medium format. A system to trust and build on, that will develop and grow in pace with tomorrow's discoveries.

The list of features is long, varied and comprehensive. Take a deep breath and read the following: 22 megapixel sensor unit interchangeable with an optional 120/220 film back, shutter speeds from 18 hours to 1/800s, automatic focus with instant manual override, dot-matrix LCDs, rapid button and control wheel user interface, integral grip, integral fill-flash, multi-mode exposure metering, TTL flash control, extremely accurate electronic leaf shutter, eyeline viewfinder with 100% view, lithium or rechargeable battery options, user customization of functions. And that's not all! Bracketing, interval timer, rapid access user button, flash measure, integral diopter adjustment in viewfinder, zone system capability, time-lapse photography, customized profiles and so on. And, apart from the practical aspects, the H1D also exudes a feeling of superb design and ergonomics that makes the camera a pleasure to own as well as use. Being Hasselblad, the results are stunning in quality too, of course.





*So Hasselblad, the most distinguished pioneer in medium-format photography, yet again takes the vanguard position. We are confident that you are going to incorporate this camera inseparably into your photographic life. We are also confident that you are going to produce images you are proud of. Some of these will remain as a documentation of the history of our world, perhaps even beyond. That's how it is with Hasselblad.*



*The primary goal of all camera development is of course the seamless and unobtrusive production of superb images, regardless of situation. The H1D has abilities and features that you may not think you need, yet. Each individual has their own way of working. But the H1D has tremendous scope for fine-tuning your technique possibly beyond your present ambitions so that is why we have decided to get you and your camera acquainted and on friendly-terms as rapidly as possible.*

*The Quick Start section of this manual is therefore intended for everybody as a rapid-access informational source, regardless of final goal. With it you should be able to take photographs 'untethered' within minutes of unpacking. The H1D will function equally well as an automatic point-and-shoot or as a total-control, ultra-professional instrument.*

*The rest of the user manual is intended to be the standard bookshelf reference manual. In it you will find full user descriptions, LCD charts, specifications, etc. There is a glossary of terms at the end of the manual if some words or terms are unfamiliar.*

*Take your time to learn the intricacies and potentials of the H1D. Go at your own pace and explore the possibilities when you feel ready for the next step. Results will be good from the word go, that's guaranteed, but there is always room for improvement, more efficient ways of working, etc and that will be up to you to determine and decide upon.*

***The supreme Hasselblad potential is there, it's up to you to exploit it!***

*Finally, please check occasionally on the Hasselblad website — [www.hasselblad.com](http://www.hasselblad.com) — for any updates regarding user instructions, changes, news, or other information concerning the H system. If you have no Internet access, please contact your Hasselblad dealer or distributor for the latest information.*





## ***What's in the box***

*Please ensure that all the items noted on the accompanying packing information have been supplied and are correct.*

*Contact your Hasselblad dealer or distributor immediately if any of the items are missing, quoting the serial numbers and purchase details.*

*Familiarise yourself with the various parts and components. Leave protective covers on as much as possible and avoid touching glass surfaces and inserting fingers into the camera body. The H1D has a robust construction and is capable of withstanding fairly rough treatment but nevertheless is a precision instrument and will serve you longer if treated with respect from the beginning.*

*Please read and take notice of the safety restrictions at the end of this manual.*

*Please keep purchase details and the warranty in a safe place.*





*The following is included with a brand new H1D:*

- **H1D camera body complete with sensor unit**
- **Viewfinder HV90X**
- **HC 2.8/80 mm lens**
- **Image Bank**
- **Link cables ( 2 pcs)**
- **FireWire cable**
- **FlexColor software**
- **Batteries for camera body**

1. Flash unit hot-shoe
2. Rubber eyecup
3. Exposure mode and metering method selector button
4. Exposure compensation button
5. Eyepiece adjustment dial
6. Grip LCD
7. Rear control wheel
8. User button
9. Camera control buttons
10. Support strap lug
11. Front control wheel
12. Shutter release button
13. Battery holder button
14. Release cord socket
15. Sensor unit socket

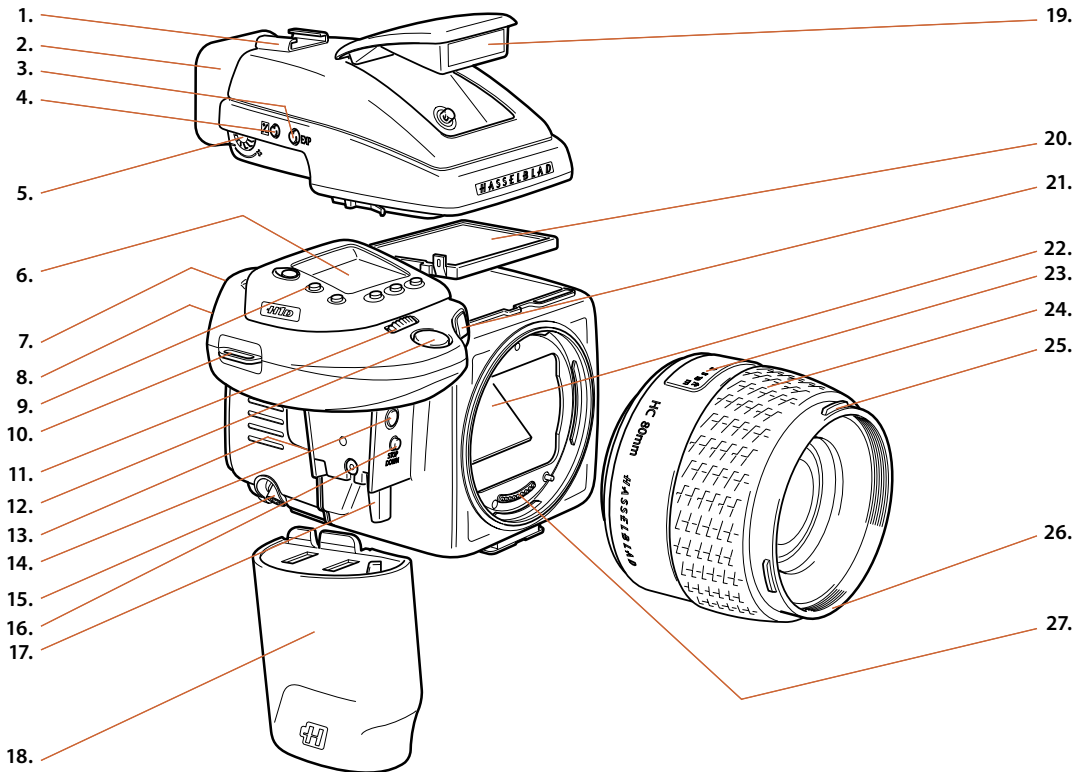

- 16. Stop down button
- 17. Battery holder retaining lever
- 18. Battery holder
- 19. Flash unit
- 20. Viewfinder screen
- 21. Focus assist light
- 22. Mirror
- 23. Distance and depth-of-field scales
- 24. Focusing ring
- 25. Lens shade bayonet
- 26. Filter screw thread
- 27. Databus connection
- 28. Viewfinder release button
- 29. Flash unit catch

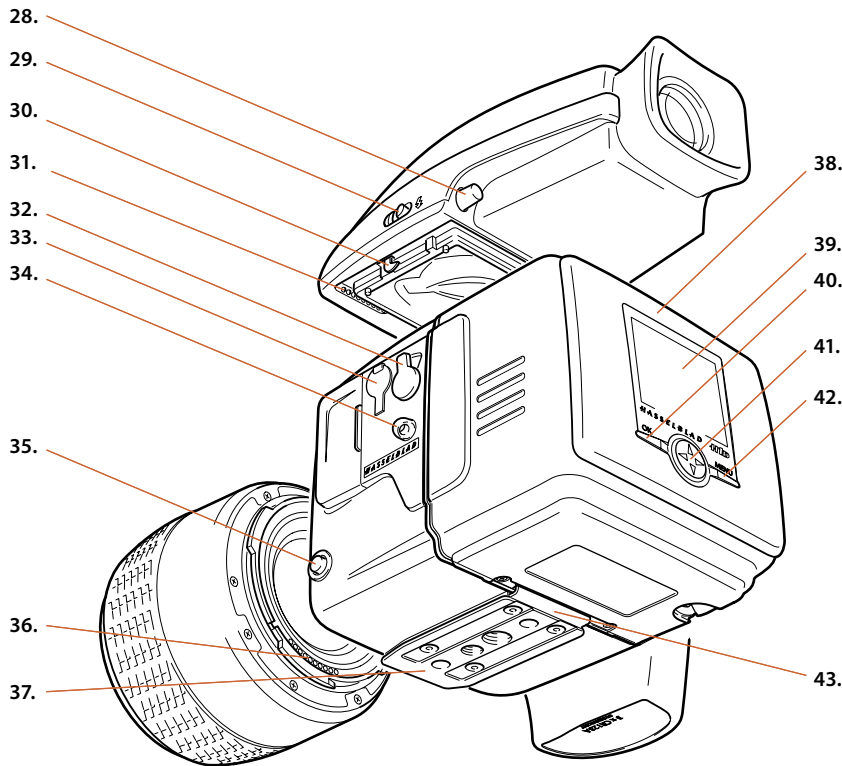

- 30. Viewfinder attachment hook
- 31. Viewfinder databus connection
- 32. Magazine release button
- 33. Flash PC socket
- 34. Camera strap lug
- 35. Lens release button
- 36. Databus connection
- 37. Quick coupling tripod plate
- 38. Sensor unit
- 39. Sensor unit LCD
- 40. OK button
- 41. Browse/scroll button
- 42. Menu button
- 43. Magazine support

- 44. Standard L-size battery
- 45. FireWire socket
- 46. External power supply socket
- 47. Link connector
- 48. Status indicator
- 49. On/Off button

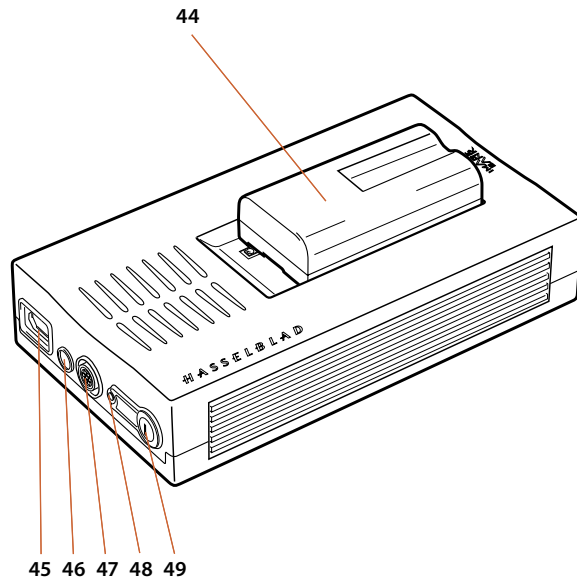

## 1

## Quick Start

*This section is mainly a quick start guide to assembling your new H1D. This process should take no more than a few minutes to complete and you will be able to take simple and straightforward photographs digitally in untethered mode.*

*See the Quick Start Chart at the end of this manual for the relevant illustrations that accompany this description.*

*Please refer to the relevant chapters and sections further in this manual for in-depth descriptions of features and procedures.*

# H1D

## Untethered



## Tethered

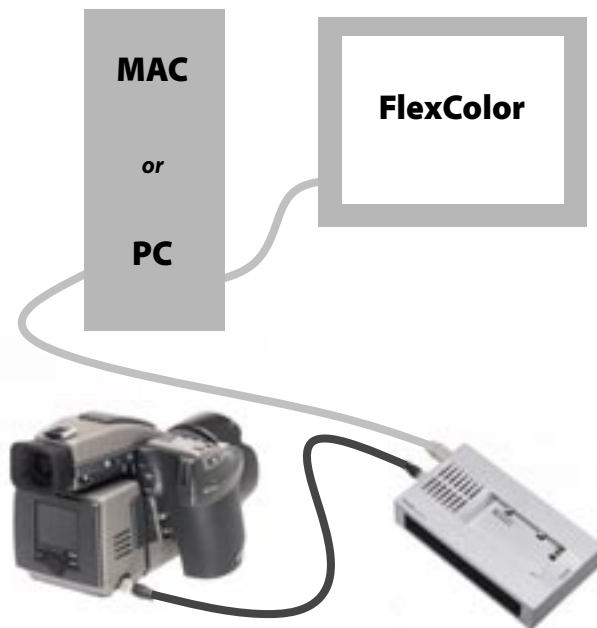

## Quick start H1D assembly from new

*The H1D can be used tethered to a computer or untethered, though in either case always connected to the Image Bank for digital capture.*

*The following procedure is a general introduction to the camera from new.*

1. Remove the battery holder from the grip by depressing the battery holder button and simultaneously swinging the battery holder retaining lever down until it stops. Pull battery holder downwards.
2. Depress the red button on the battery holder until the battery cassette is released. Withdraw the cassette from the holder.
3. Load three CR-123 Lithium batteries into the cassette, ensuring the polarity of each battery is correctly oriented (see the '+' markings on the cassette). Re-insert the cassette into the battery holder, ensuring the red button clicks back into its retaining position.
4. Holding the battery holder flat against the grip and aligning the two upper lugs with the slot in the grip, slide it back into position as far as it will go. Swing back the battery holder retaining lever until it clicks back into place.
5. Remove the front protective cover from the camera body by keeping the lens release button depressed and rotating the cover counter-clockwise until it is released.
6. Remove the lens shade by turning it clockwise.
7. Remove the rear lens cap by unscrewing it in a counter-clockwise direction.
8. Attach the lens to the camera body by firstly aligning the red index on the lens mount with the red index on the camera mount. Grip the lens by the metal barrel (not the rubber focusing ring) and turn it approximately one quarter turn clockwise until it clicks into place.
9. Remove the front lens cap by pinching together the two retaining clips.
10. Attach lens shade to lens by aligning the indexes and turning the shade clockwise a quarter turn.
11. Remove the top protective cover from the viewfinder screen location by lifting a corner.
12. Remove the protective cover from the viewfinder by depressing the viewfinder release button.
13. While holding the viewfinder at a slight angle, locate the front section into place on the front edge of the viewfinder screen recess in the camera body ensuring the central locating lug and databus interface are positioned correctly. Swing the viewfinder downwards and press firmly until it clicks into place. Ensure that both sides of the viewfinder are seated correctly.
14. Point the camera at a smooth toned area. Turn the eyesight adjustment dial until you achieve optimum sharpness of the markings on the viewfinder screen.

## Quick Start Guide







15. Attach a fully-charged battery to the Image Bank by placing it in the central depression and then pushing it towards the electrical contacts until it clicks into place.
16. Take one end of the Link Cable and attach it to the socket on the Image Bank. Rotate the connector a little until the pins find the correct position, then push the connector into place.
17. Attach the other end of the cable to the socket on the sensor unit of the camera in the same manner.
18. Press the ON/OFF button on the Image Bank (please remember this routine sequence). After a few seconds the indicator lamp beside the button should display green to indicate correct function.
19. Press the ON.OFF button on the camera grip for half a second to activate the camera. If the camera was already activated but in STANDBY mode, it will now automatically be reactivated by the image bank being activated.

If the camera enters STANDBY mode (the LCD screen will show the H1D symbol only), reactivate it by pressing the shutter release button half-way (or the ON.OFF button or Stop down button).

*You can now explore the menus, buttons, control wheels, etc observing the changes on the LCD on the grip as well as the LCD in the viewfinder.*

### ***and finally ...***

20. From the inactive mode, press the ON.OFF button until you see the H1D logo on the grip LCD. The LCD then in turn displays the 'standard' screen. If the camera is already in STANDBY mode (the H1D logo will be visible on the grip LCD) click on either the shutter release button or the ON.OFF button to activate it again. (Note that a 'click' action is a quick press. See later section for a description of different button pressing actions)

*Your Hasselblad H1D is now operational in fully automatic, untethered mode. In average lighting conditions the camera will act as a point and shoot camera producing extremely fine results without the need to touch any other button than the shutter release!*

21. After composing your picture, gently press the shutter release button. The camera will automatically focus the lens, take a light reading, make an exposure and reset the camera ready for the next exposure.
22. If the exposure was judged as correct by the sensor unit, you will hear a short indicating sound. The image will also appear on the rear LCD.

### ***that's it ...***

*The image is now stored in the Image Bank until transferred or deleted.*

### *and finally to turn the camera off:*

23. Press the ON/OFF button on the Image Bank for about two seconds. This is confirmed by a 'twittering' indicating sound. The camera automatically enters STANDBY mode to reduce battery consumption and this is confirmed by the appearance of the 'Turn on Image Bank' message on the grip LCD.
24. Release the cable from the camera and Image Bank by pulling straight out on the connector collars.

### **Familiarize yourself with the H1D**

*Take a few minutes to familiarize yourself with the H1D and its various controls. Note the difference between a long press and a short press with some buttons. For example from the standard screen a click of the **ON.OFF** button will take you to Profiles while a longer press will turn the camera off.*

*You should find that the H1D sits comfortably in the palm of your left hand leaving your fingers free for eventual manual focus adjustments. With your right hand on the grip, your thumb and fingers have immediate access to all the controls without letting go. Move the rear control wheel with your thumb and the front control wheel with your index finger.*

*Note the changes on the grip LCD as you press the various buttons and control wheels. Notice too the changes in the viewfinder LCD as you do the same. You cannot damage the camera by pressing the wrong buttons or controls or using them in the wrong order. The worst that can happen is that you might get 'lost' in the menu or you might activate a certain action that takes time to complete. In this case simply click on the escape (**PROFILES / ESC**) button to return to the 'standard' screen again.*

*Attempt a half-press with the shutter release button with the camera set at autofocus too see how the lens focuses and the light metering reacts. Notice that the lens barrel does not revolve in autofocus but you can immediately change the focus manually and immediately revert to autofocus again by using a half-press again.*

*Note the ready accessibility of the very handy User button for access short cuts to most functions (investigate how you can exploit this excellent function to the full in a later section) as well as the AE-Lock button for immediate exposure locking.*

*Feel for the stop down button positioned between the lens and the grip.*

*Press the AF button and then turn the front control wheel to change from AF single to AF continuous to Manual to try out the differences in how the camera behaves in these different modes, for example.*

*Press the EXP button on the viewfinder and then turn the rear control wheel to change the metering method to see the changes in sensitivity of the exposure meter.*

*Quite simply, just explore the camera for a little while to feel at home with the general handling and the idea of control buttons and wheels and LCD information, etc. The sooner you become accustomed to moving the controls instinctively the sooner you will be able to effortlessly use the finesses on offer.*

*The remainder of this manual will slowly take you through stage for stage each feature and setting so that you can master this marvellous piece of photographic equipment and exploit it to the full.*

# H1D

## 2

## Function Control & Display

- LCD and LED displays on camera and viewfinder
- Pixel based display
- Upgradeable software
- Rapidly accessible menu
- Interactive display
- Customizable functions

# H1D

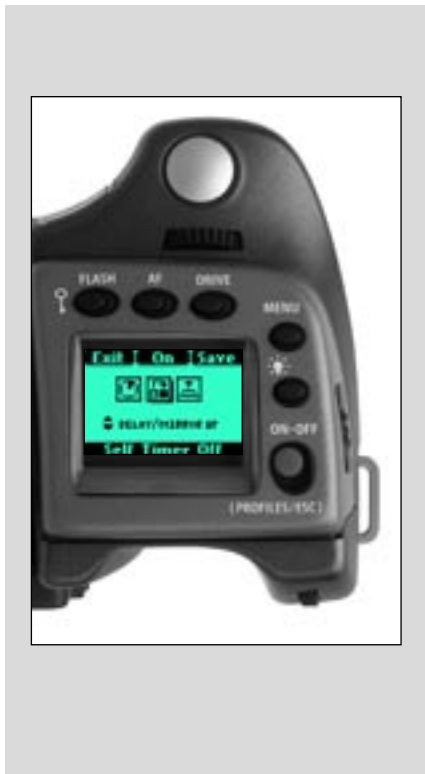

All functions and settings on the H1D are accessed and altered by the readily accessible control buttons and wheels on and around the grip and on the sensor unit. The information on the LCDs is in menu format and has a great deal in common with those found in modern computers, cell phones, etc. It is pixel based and therefore has a greater capacity to produce user-friendly symbols. The viewfinder also has an LCD visible beneath the viewing frame that mirrors some of the information on the grip LCD plus additional information as well as four LEDs for warning, flash and focus information. Please see separate sections for further details about the viewfinder.

Even though there is crossover and interconnection of facilities, essentially control can be divided into two areas for the sake of explanatory simplification. The camera's ability to control lens settings, make light measurement etc is governed by controls around the grip while digital capture control is governed by controls on the digital sensor. The following is a description of the controls on and around the grip. Please see later section 'Sensor Unit' for a complete rundown of the sensor unit's facilities.

Below is an overview of the primary functions of the control wheels and buttons. Some controls have dual or triple functions according to the state of the menu. A full description can be found further on in this chapter.



#### ***Shutter release button***

Activates camera and releases shutter

#### ***CONTROL LOCK / FLASH button***

Lock settings to avoid inadvertent change.  
Also accesses flash settings.

#### ***AF button***

Accesses focus modes.

#### ***DRIVE button***

Accesses the various drive (film advance) modes.

#### ***Front control wheel***

Accesses various settings.

#### ***MENU button***

Accesses menu.

#### ***Illumination button***

Illuminates grip LCD.

#### ***ON.OFF (PROFILES/ESC) button***

Turns the camera on and off. Accesses Profiles and acts as escape button for other functions.

#### ***Rear control wheel***

Accesses various settings.



***M.UP button***

Raises and lowers mirror.

***Remote release cord port***

For attaching a remote release cord (electrical).

***STOP DOWN button***

Stops down aperture to current setting.



***AE-L button***

Locks light reading made in both automatic and manual exposure modes.

***Film wind-off button***

Winds off film before film is finished.

***USER button***

Rapid function-access button



***Eyesight correction adjustment wheel***

Personal eyesight adjustment facility.

***EV correction adjustment button***

Produces EV compensation.

***EXP button***

Accesses exposure mode and metering method.



**Typical camera grip display.** (The information in brackets describes this particular example).

Flash condition indication  
(No exposure compensation,  
normal flash synchronisation)

Focus setting  
(Autofocus setting, single shot mode)

Drive condition  
(Single setting)

Aperture setting  
(f/5.6)



Shutter speed setting  
(1/20s)

Exposure Value display (EV 9.3)

Film speed rating  
(160 ISO /ASA)

Exposure mode indication  
(Automatic exposure setting)

Metering method indication  
(Average)

Sensor format

Low battery symbol

White balance

## Typical camera grip display when changing settings.



### Command indication

The upper row on the screens describes commands (which change according to the setting). The button immediately above each command effects the change. So in this case, for example, you would press the FLASH button to 'exit' from the screen.

### Settings symbols

Symbolize the options available when settings are changed. The active symbol is depicted by a drop shadow.

### Control wheel description and direction

Arrowheads symbolize which control wheel should be used to change the setting they are beside. In this case, the Bracketing option is chosen by the front control wheel and the number of exposures in that option is chosen by the rear control wheel.

◀...▶ = front control wheel

◆ = rear control wheel

### Setting information

The lower row on the screen displays information about the current state of the setting. In short, the upper row displays what you can do, and the lower row displays the current state of settings or what you have done.

**Typical viewfinder display.** Note the LEDs will only be visible when activated (by the camera or a setting).  
(The information in brackets describes this particular example).

Exposure method setting  
(‘aperture priority’ mode)

Aperture setting  
(f/4.8)

Exposure compensation  
setting reminder symbol

Metering method setting  
(average)



Flash LED

Warning triangle LED

Exposure compensation  
setting (+0.7 EV)

Shutter speed setting  
(0.4 second)

Film magazine  
status (empty)

Focus aid LED

Some examples of various viewfinder LCD screens visible with standard settings and when specific control buttons are pressed.

Standard settings	 Normal screen	 Normal screen in AE lock state	 Normal screen with exposure compensation set
<b>FLASH</b> 	 Flash mode		
<b>AF</b> 	 AF mode		
<b>DRIVE</b> 	 Drive mode		
<b>MENU</b> 	 Menu mode		
<b>+/-</b>	 Exposure compensation mode		
<b>Exp</b>	 Exposure method and metering method		

## **Menu charts – general**

*Throughout this manual you will find charts to explain the steps and procedures required to alter the various settings. These charts are laid out to graphically illustrate in a simple manner how to navigate through the menus. While they include all the information that would be presented on the LCD relevant to that section, they cannot illustrate all the possible combinations of the various symbols seen on a screen at one time as that would be impractical and too confusing. If you are at all familiar with cell phone menus, for example, then the design of the layout and working practice will not be unfamiliar.*

*You should find that, in practice, working your way through a menu on the camera is a good deal simpler and more obvious than the written explanation implies!*

*In the descriptions, various terms are used regarding menu navigation. Menus have 'trees', for example, which describes their imaginary graphical layout where you could trace a navigational path along its 'branches'. Each new section, or stopping off point on the branches, seen on the LCD is called a 'screen'. Therefore a screen is the graphical display on the LCD of where you are on the menu and represents the current state of settings.*

*The H1D features the advantage of multiple customization of settings. This means that your personal choice of settings, and thereby appearance of various combinations of symbols on the LCD at any time, will not necessarily be the same as many of the screens illustrated in this manual.*

*To simplify the descriptions, reference is often made to a 'standard' screen. Apart from default settings, there is no actual standard setting in the normal sense and therefore you create your own 'standard', which of course can be changed at any time.*

*The 'standard' screen is therefore the one you have currently created and is the one visible on the LCD when photographing (except where a particular mode is in actual operation, such as self-timer, for example).*

The following is a list of various terms describing various actions that appear in the menu:

**Enter** : moves screen down one level on the menu.

**Exit** : moves screen back up one level on the menu. Does not save any settings.

**Off** : deactivates the particular function being set.

**On** : activates the particular function being set.

**Sel.** : Select - selects the character marked when imprinting text and profile name.

**ESC** : Escape - terminates an action and returns to the standard screen. Does not save any settings.

**Save** : saves a setting and also moves screen back up one level on the menu. Can save many changes made in a setting sequence.

.....

Remember the following groupings of 'saved' and 'not-saved' actions when making settings changes:

#### **SAVED**

'Quick save' - half-press shutter release button

Save - press save button (DRIVE button)

#### **NOT SAVED**

Escape - press ESC button (PROFILES /ESC button)

Exit - press exit button (FLASH button)

## Symbols used in the charts



*Use front control wheel*  
(direction depends on user setting)



*Use rear control wheel*  
(direction depends on user setting)



*Press button or turn wheel*



*MENU button on the grip*



*Choose ENTER*  
(by pressing DRIVE button on grip)



*Choose ON*  
(by pressing AF button on grip)



*Choose Save*  
(by pressing DRIVE button on grip)

The new setting will be saved and chosen action can be carried out. Setting will be retained until changed.



*Functions in loop on menu*

A loop means that the available functions on that particular branch of the menu can be successively accessed in either direction of the control wheels without a break in flow. That is, you could turn the wheel to the left or the right to arrive at the desired function.



*Main direction of path through menu*

The main path traces step-by-step the path that has to be taken through the various branches of the menu tree as they appear on the LCD to reach the relevant functions.

## General overview of camera menu

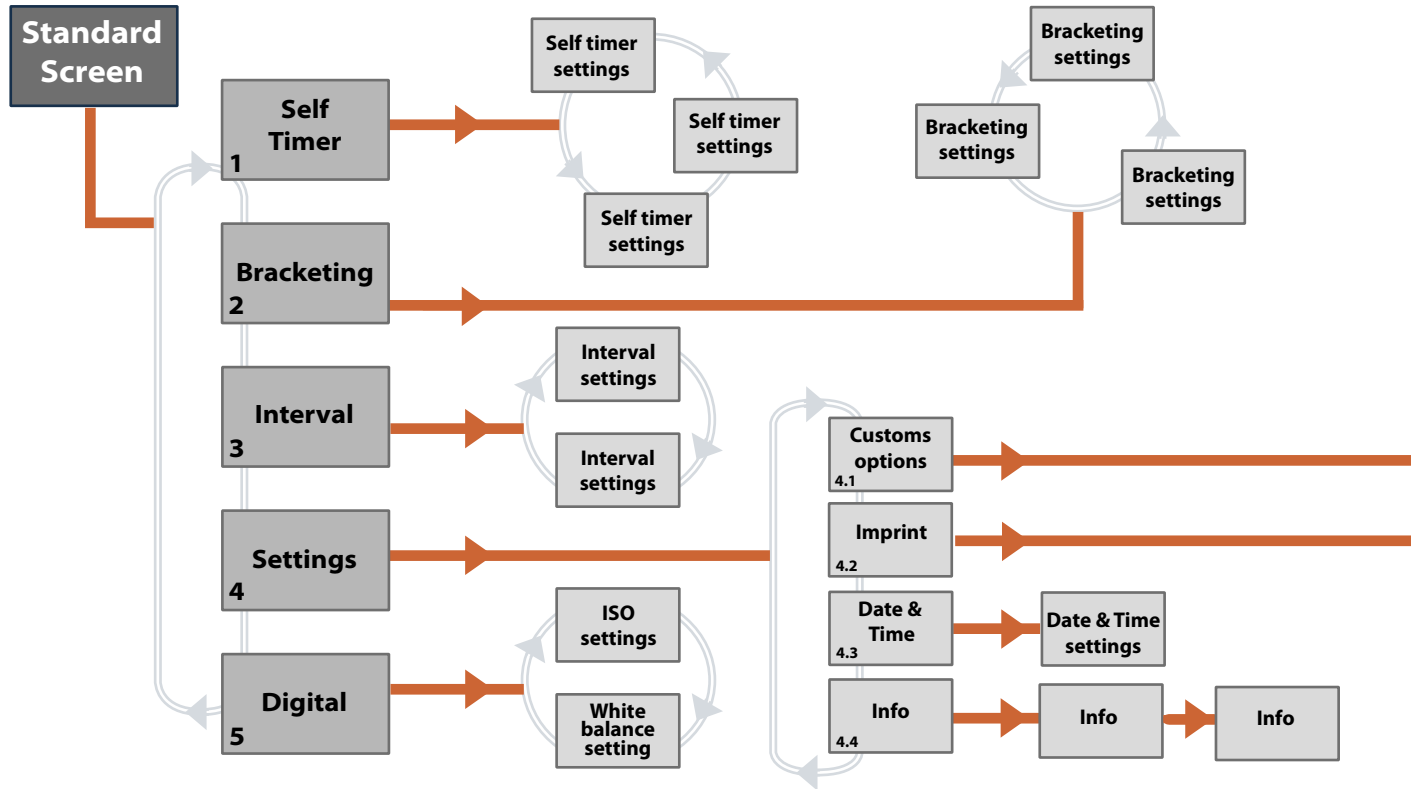



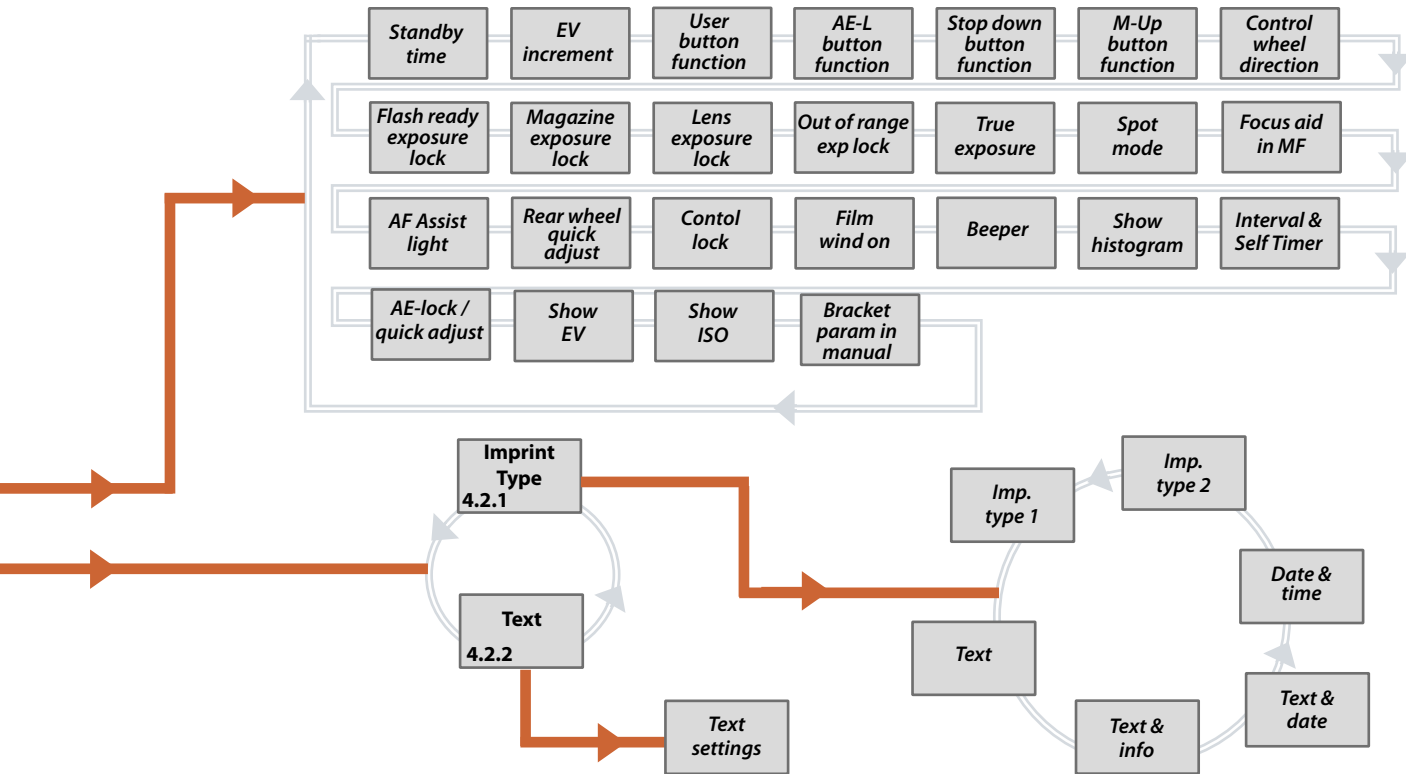





## Grip controls

There are five buttons that surround the grip LCD combined with two control wheels to access various parts of the menu and to alter settings. Additionally there is an LCD illumination button as well as the shutter release button.

The basic principle behind making changes is that the appropriate button is first pressed to access the menu and then settings altered by way of the control wheels. The appropriate control wheel is designated by arrowheads alongside the setting description.

-  Some buttons have a toggle function, the ON.OFF button has a quick 'click' action as well as a longer (half-second) 'press' action and the shutter release has two positions: 'half-press' and 'full-press'.
-  Many buttons have a dual or triple function according to the state of the menu.
-  At very low temperatures the LCDs require approximately a few seconds to display new settings.

Several buttons are multifunctional, according to the state of the menu. For example, if you press the DRIVE button when the standard screen is visible, it will access the drive mode choice screen. The new screen then shows a new description for the buttons and so the DRIVE button now functions as the SAVE button temporarily until a new screen is visible.

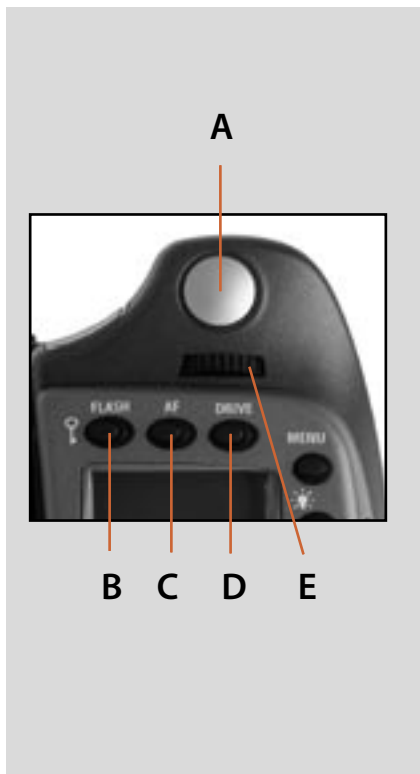

### **Shutter release button**

**A**

This button has *half-press* and *full-press* positions. By pressing half-way (or softly) the camera, auto focus function and exposure meter can be activated. By pressing all the way down (or harder) the shutter will be released (or the chosen exposure procedure will begin, as relevant. For example, the self timer is activated with this button)

### **CONTROL LOCK / FLASH button / (EXIT)**

**B**

This is a triple function button. If you press the button for one second, the beeper will sound (if set) and a key symbol will appear on the grip LCD signifying that the controls (except the shutter release) have been locked and therefore cannot be altered unintentionally in use. Press the button for one second again to unlock (this function can be altered to lock all controls or control wheels only in 'Custom options').

Quickly clicking the button will access the flash settings screen on the LCD from the standard screen. See separate section for full details. This button also acts as the **EXIT** button for many other settings.

### **AF button / (ON) / (SEL.)**

**C**

This is a triple function button. Press this button to go directly to the autofocus/manual focus choice screen from the standard screen. See separate section for full details. It also acts as the **ON** and **SEL.** (= select) buttons for many other settings.

### **DRIVE button / (SAVE) / (ENTER)**

**D**

This is a triple function button. It will access the drive settings screen on the LCD from the working screen. See separate section for full details. It also acts as the **SAVE** and **ENTER** buttons for many other settings.



### ***Front control wheel***

***E***

The front and rear control wheels are turned to make changes in exposure settings in the standard screen as well as to access the various loop sections of the menu for settings. The effect of the wheels' direction is programmable.

### ***MENU button***

***F***

Accesses the first level of the menu for settings changes.

### ***Illumination button***

***G***

Press to illuminate the LCD. Remains active until camera enters standby mode.

### ***ON.OFF (PROFILES/ESC) button***

***H***

Press the button for a half second to activate the camera. The H1D start-up logo will appear and then the standard screen. After a few seconds (customizable) the camera will enter Standby mode. A half second press of the button will turn the camera off completely.

The Profiles section of the menu is accessed by clicking the button quickly from the standard screen.

Note the difference between a half second press and a quick click of the this button.

### ***Rear control wheel***

***I***

The front and rear control wheels are turned to make changes in exposure settings in the standard screen as well as to access the various loop sections of the menu for settings. Acts as quick access exposure compensation control. The effect of the wheels' direction is programmable.

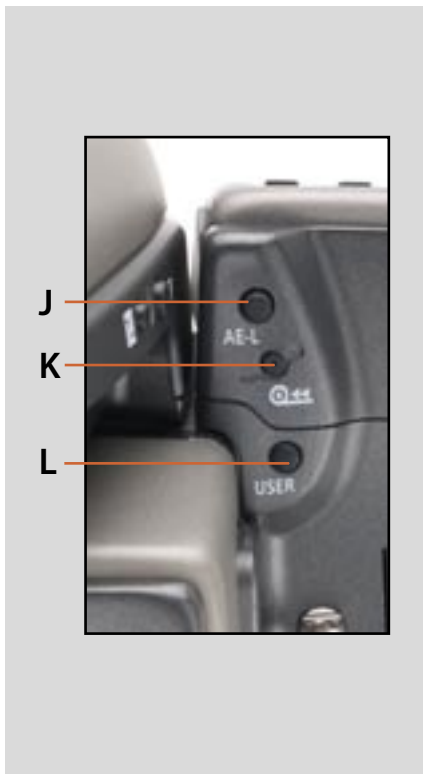

On the rear of the grip, as well as the rear control wheel, there are also a further three control buttons:

### **AE-L button**

**J**

This button that can lock a light reading made in both automatic and manual exposure modes. It can also be used in Zone mode to take a new reading. **Can be designated another function in Custom options.**

See section on the AE-L button for full details.

### **Film wind-off button**

**K**

Pressing this button will automatically wind-off the remaining unexposed film rapidly without having to go through the normal film advance / expose cycles to reach the end of the film. The button has been purposely designed to avoid inadvertent pressing, so use the tip of a ball-point pen or similar to activate it. The grip LCD will display a message which you must confirm before this procedure is carried out.

### **USER button**

**L**

This button is used to rapidly access a chosen function or screen. For example, you might use bracketing a great deal and so by one press of this button you could access the bracketing function without having to navigate through the menu. **Can be designated another function in Custom options.**



*This button is particularly useful and can save you a great deal of time and effort depending*



on how you work. You are advised to investigate fully the potential of this button's function. See under 'Custom settings' for full details.

On the front of the grip there are two more control buttons plus the remote cord release port:

#### ***M.UP button***

***M***

Press this button to raise the mirror and press again to lower it (toggle function). A quick double press of the button (two within a half second) will immediately access the 'Self timer' function. **Can be designated another function in Custom options.**

#### ***Remote release cord port***

***N***

For attaching a remote release cord (electrical). The Hasselblad accessory jack plug socket is protected by a captive rubber plug.

#### ***STOP DOWN button***

***O***

Press this button to make a visual check of the depth-of-field on the viewfinder screen at the chosen aperture. The aperture will close according to the setting and remain closed as long as the pressure is maintained. You can alter the aperture at the same time to see the changes taking place. **Can be designated another function in Custom options.**



P

Q R

There are also two control buttons on the viewfinder, as well as the eyesight correction adjustment wheel:

### ***Eyesight correction adjustment wheel***

**P**

The personal eyesight adjustment facility has a diopter range of -4 – +2.5, to suit most users.

### ***EV correction adjustment button***

**Q**

Press this button to access the EV compensation screen. Settings are made with either the front or rear control wheels. An EV correction symbol appears on the grip and viewfinder LCD as confirmation.

### ***EXP button***

**R**

The EXP (Exposure) button accesses the exposure mode and metering method options screen. Settings are made with the front and rear control wheels and the appropriate symbols appear on the grip and viewfinder LCD accordingly.





**3**

## Sensor unit & Image Bank

- 22 million pixels
- Up to 850 images at full resolution

# H1D



*The H1D can be used untethered or tethered. 'Untethered' means that the camera is connected only to its Image Bank which acts as an image storage facility and power supplier to the sensor unit ( the camera body, viewfinder and lenses take their power requirements from the batteries in the grip). 'Tethered' means that the combined camera and Image Bank are connected to a computer.*

*The Image Bank then controls the communication between the sensor unit and the computer as well. The Image Bank can store up to 850 shots at full resolution on its hard disk to be transferred to a computer later. The link cable connects the sensor unit on the camera to the Image Bank. The fire wire cable connects the Image Bank to the computer.*

*The sensor unit houses a light-sensitive element called an area array CCD (charge coupled device), which acts as computer-readable electronic 'film'. The surface of the CCD has 22 million light- sensitive areas, each of which creates a pixel in your final digital image. In a colour digital image each pixel has three colour components: red, green and blue (abbreviated RGB). The pixels in the sensor unit's CCD are filtered to create three images – one of each colour – which are later combined by the software to create a single full colour image.*

*When using the camera untethered, the built-in digital light meter, with full histogram display and audio exposure warnings, helps to ensure a perfect exposure.*

*When using the camera tethered in a studio you can control all the digital aspects of camera operation from your computer using the FlexColor image capturing software. See the "FlexColor Software Reference" manual for details.*

zoom

## **Features**

### ***Control panel & display***

---

The 2 inch colour display provides instant image preview, allows you to browse through all pictures currently saved in the Image Bank, read information and exposure data from each picture and make basic camera settings.

### ***Link socket***

---

Attachment socket for link cable to provide connection to the Image Bank.

## **Shooting modes**

The H1D captures images in two different modes:

### ***Preview mode (tethered mode only)***

---

Captures a low resolution image and applies minimal processing. This type of capture appears most quickly on your computer screen. Use it to check your exposure and composition and to make initial neutralization settings.

### ***Normal mode***

---

Captures an image and applies full processing. Images are fully rendered and processed so they take slightly longer than previews. The results are high resolution images of production quality.

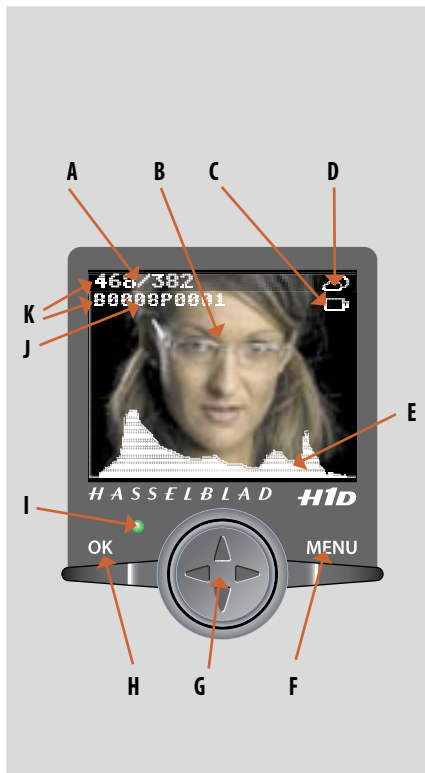

## Control panel

When using the H1D untethered some features are controlled from the control panel on the sensor

*The control panel displays the following:*

- A Image counter:** shows the number of images currently stored in the Image Bank and how many images there are left until the Image Bank is full.
- B Image preview:** generated within 2 secs.
- C 'Battery Low':** appears and flashes to indicate low charge state of the Image Bank battery when operating disconnected from a computer.
- D 'ISO high':** appears and flashes to indicate that current ISO setting is higher than 50 and thereby increasing the risk of noise in the captured image.
- E Exposure Info:** shows a histogram curve indicating the overall brightness and contrast of the current shot. From the **Setup** menu you can select whether or not to display the histogram.
- F MENU button:** displays the 'Menu' from where you can make the various device settings - see 'Using the Control Panel' for details.
- G Browse/Scroll button:** use to browse through images in the Image Bank and to scroll through menu items - see 'Using the Control Panel' for details. Use the button to enter the zoom function and to move the zoom box around - see 'Zooming' for details. The button also can be set to function as an exposure button.
- H OK button:** use to enter 'Browse' function and to change/confirm settings - see 'Using the Control Panel' for details.

- I **Status Indicator:** indicates that power is supplied to the camera back and the colour indicates the current status of the camera back:  
**Red** = Error, **Yellow** = Busy, and **Green** = Ready.
- J **Picture name:** shows the name of the picture currently previewed. The name given to each new shot is based on the setting of the **Batch** parameter.
- K **Image Info:** shows info (items **A** and **C**) for the image currently previewed. From the Setup menu you can select whether or not to display the info.

## Using the control panel

### Displaying images

*When power is supplied to the sensor unit it starts up showing the main window:*

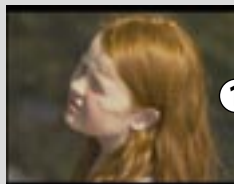

1. *The picture displayed in the main window is the latest shot. To change the display to show the image info and histogram press **MENU** button.*

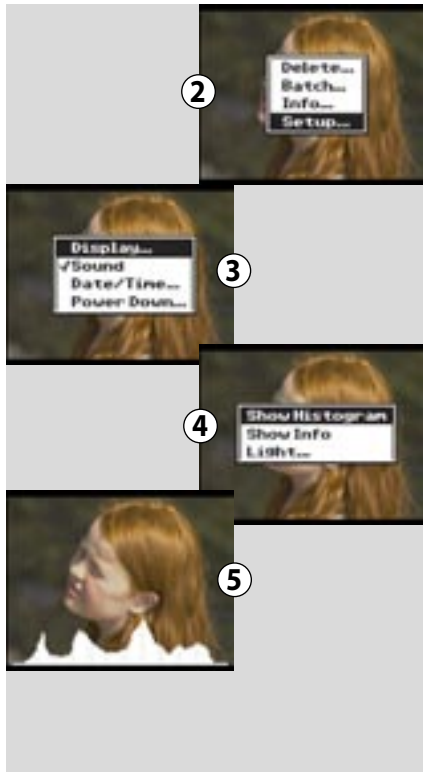

2. In the pop-up menu use **Browse/Scroll** button to highlight the **Setup** item, then press **OK** button to enter.
3. Now scroll and highlight the **Display...** item and press **OK** to enter.
4. Highlight **Show Histogram**. Press **OK**.
5. The histogram for the current image will be displayed on the lower edge of the image on the LCD.



6. Repeat the procedure to select **Show Info (Setup → Display → Show Info)**. The information for the current image will be displayed on the top left of the image on the LCD. Press the **OK** button to enter 'Browse' mode. A figure will appear at the bottom right of the image to signify this.
7. Use **Browse/Scroll** button to browse through the images currently stored in the Image Bank. Press **OK** button to select the picture you want to display.
8. The display returns to the main display showing the latest shot.

### **Zooming**

When previewing an image, either in the main window or in **Browse** mode you are able to zoom into the image to view details. To do so press any direction on the Browse/scroll button except for the centre which could be assigned to function as exposure button. Generally it is recommended to use Up or Down as the Left and Right keys will still function as browse keys when in **Browse** mode.

1. Press **Up** or **Down** on the **Browse/Scroll** button to display the Zoom Box.

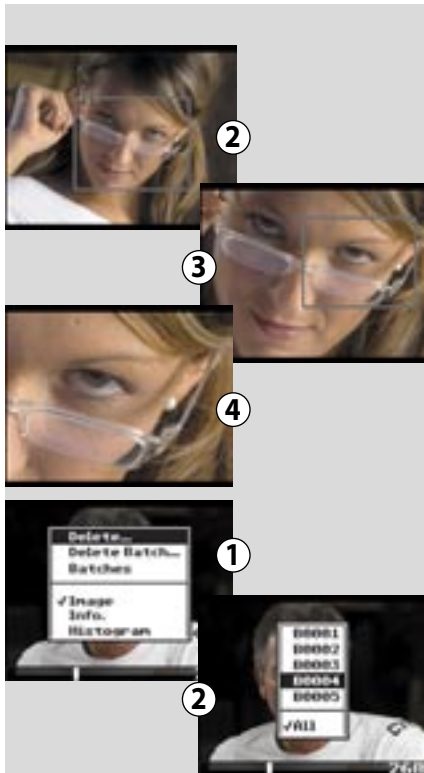

Now use the **Browse/Scroll** button to move the Zoom Box to the area in the image you want to zoom into, then press the OK button.

If necessary repeat procedure until max. zoom level (3 times) has been reached. You can exit the zoom function anytime by pressing the MENU button.

2. (Zoom level 1)
3. (Zoom level 2)
4. (Zoom level 3)

### Browse options

When in 'Browse' mode you are able to specify the images you want to browse through and how to display them:

1. From the main window press **OK** button to enter 'Browse' mode.  
Press **Menu** button to display the 'Browse' menu, then use **Browse/Scroll** button to highlight the **Batches...** item and press **OK** button.
2. From the appearing list select a batch number to browse through the pictures from this batch only or select **All** to browse through all pictures.



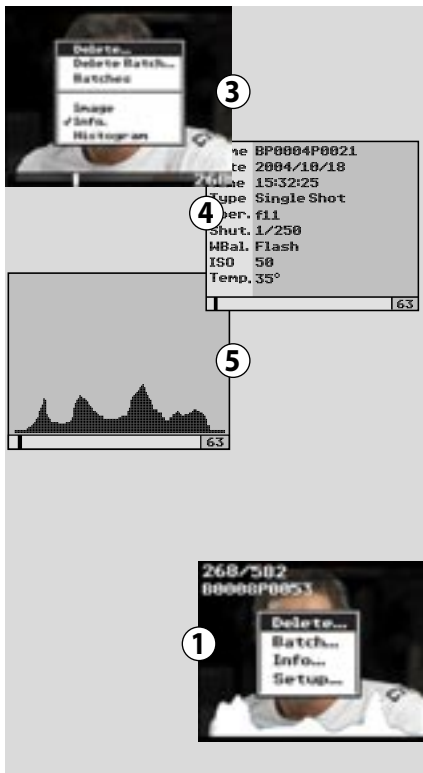

3. The number to the right in the 'Browse' bar indicates the number of images captured onto the image bank in the selected batch.

Press **MENU** button. From the menu you have the option of selecting between 3 different ways of displaying the images: **Image** (current), **Info**, and **Histogram**. Select **Info** and press **OK** button.

4. The **Info** window shows the name, capture date and time, and the various device settings used for the current image.
5. If you select **Histogram** the histogram for the current image is displayed.

### Deleting images or batches

Deleting images is possible from both the main display and in 'Browse' mode while deleting batches is only possible in 'Browse' mode.

1. From the main display you can delete the currently previewed image by pressing the **MENU** button and in the pop-up menu highlight **Delete...** and press **OK** button.



2. Use **Browse/Scroll** button to highlight either **Yes** (to delete) or **No** (to cancel) then press **OK** button to confirm.
3. Alternatively press **OK** button to enter 'Browse' mode, use **Browse/Scroll** button to find the image you want to delete and press **MENU** button. In the menu highlight **Delete...** and press **OK** button.
4. Use **Browse/Scroll** button to highlight either **Yes** (to delete) or **No** (to cancel) then press **OK** button to confirm.
5. If you want to delete a whole batch of images select **Delete Batch...** from the menu and press **OK** button.
6. In the appearing batches list highlight the batch you wish to delete and press **OK** button.

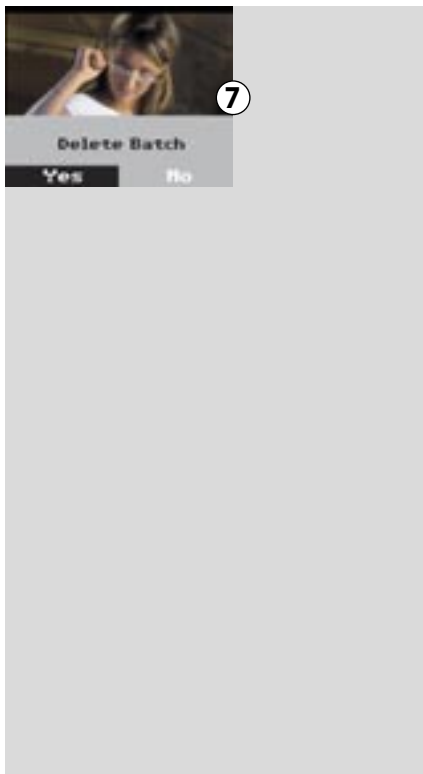

7. Use **Browse/Scroll** button to highlight either **Yes** (to delete) or **No** (to cancel) then press **OK** button to confirm.

### ***Changing settings on the camera menu***

ISO and White Balance settings are changed by way of the main camera menu, as follows:

1. Press the **MENU** button on the grip.
2. Turn the front control wheel until the **Digital** (screen 5) appears.
3. Press **ENTER (DRIVE button on the grip)**.
4. Turn the front control wheel to access the options, that are:

#### **ISO setting and White balance**

5. In **ISO Setting** turn the rear control wheel to choose an ISO value of 50, 100, 200 or 400.  
In **White balance** turn the rear control wheel to choose between manual, flash, daylight or tungsten.
6. Press **SAVE** (the **DRIVE** button) or half press the shutter release button to save the setting.

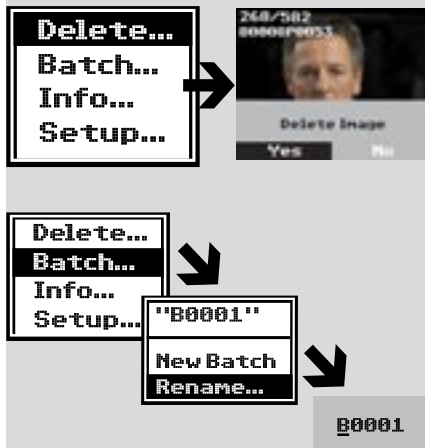

### Changing settings on the sensor unit

The menu holds all the parameters for setting up the sensor unit

To enter the menu press **MENU** button from the main window. Use **Browse/Scroll** button to scroll through the menu items - please note that holding down the button will make scrolling quicker.

To enter an item highlight it and press **OK** button. A check mark indicates the current setting. Use **Browse/Scroll** button to highlight new setting and press **OK** button to confirm. To exit without making changes press **MENU** button.

*Below are described the various settings available from the menu:*

#### Delete...

Deletes the currently previewed image.

Use **Browse/Scroll** button to highlight either **Yes** (to delete) or **No** (to cancel) then press **OK** button to confirm.

#### Batch...

The **Batch** function makes it easy to identify images from various photo sessions.

When starting a new photo session, first define a new batch name, either by using the name automatically assigned by Ixpress or use a name of your own choice. Every capture will now be named with the current batch name followed by automatically generated consecutive numbers starting from P0000.

Bank	IX04339070
Ver.	192/24
Back	IX04122051
Ver.	43557/199
1Shots	378
4Shots	0
16Shots	0
Video	0h 15m
OnTime	18h 34m

### Info...

Shows the serial numbers of your sensor unit and Image Bank.

It also lists the total number of captures shot, the time used in 'Live Video' mode and the total time in which the unit has been switched on.

### Setup...

This function holds the general settings for the camera back.

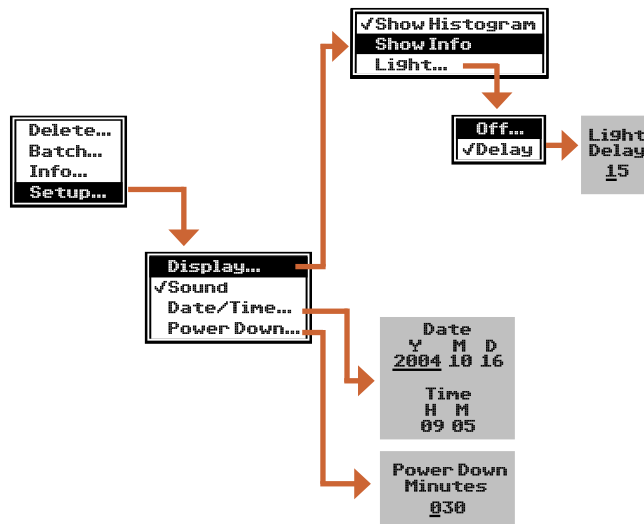

Use the **Display -> Show Histogram** and **Show Info** settings to display the histogram and info bar respectively for the current image on top of the preview image - see 'Displaying Images'.

Use the **Display -> Light...** setting to turn the display background light on or off.

When using the **Delay...** function the light is set to automatically turn off after a certain time of inactivity.

The camera is able to play 3 different sounds to indicate 'Camera Ready', 'Image Overexposed' and 'Image Underexposed' respectively.

Use the **Sound** setting to enable or disable the sounds. See "Taking Pictures" for details.

Use the **Date/Time...** entry to set the current date and time. The date and time is added to the image file information.

In the **Power Down...** entry you can set the time of inactivity after which the Image Bank and camera back should automatically turn off.

To turn the units on again use the On/Off button on the Image Bank.

### **Basic System Set-up**

Some parameters like can be adjusted either on the camera's sensor unit or via the FlexColor user interface on a computer.

The settings are stored in the sensor unit. If you change any of these settings on the sensor unit while working disconnected from the computer, FlexColor will reflect these changes once the sensor unit is reconnected.

If you make the same changes in FlexColor while the sensor unit is not connected it will have no effect.

## ***Error messages***

When working with the H1D untethered the following error messages in the rear display ensure complete control of image quality.

Each message is accompanied by a low key error sound:

### **'Image transfer error'**

An error has occurred between the camera and Image Bank.  
Please check the link cable and connectors for proper functionality.

### **'Camera body error'**

An error has occurred between camera and Ipress camera back.  
Please check exposure cables, connectors, and batteries.

### **'Time out exposure error'**

The camera back receives a time out signal while waiting for the exposure to finish.

Please check that the exposure time is set correctly.

### **'Camera not compatible (H1D only)'**

The H1D sensor unit will only function with an H1D camera



## The Image Bank

### General

The Image Bank controls the communication between the camera and a computer and supplies power to the sensor unit.

While shooting in the studio with the H1D tethered to a computer, the Image Bank generates the preview image (in 2 secs.) for viewing and processing in FlexColor.

During untethered operation, the H1D is powered by its own batteries in the grip and the Image Bank is powered by a standard lithium ion battery (see Technical Specifications). All shots are saved straight to the Image Bank's hard disk, which has a capacity of up to 850 shots. The disk is specially formatted to automatically maintain full speed throughout its lifetime.

After shooting, simply connect the Image Bank to a computer to view, select and process your images in FlexColor. See 'Transferring Images'

### Features

**A. Standard L-size battery:** enables up to 8 hours of computer-free operation. See 'Technical Specifications' for appropriate battery types.



*In case the Image Bank is connected to a computer (ex. a laptop computer) which is incapable of supplying sufficient power to the Image Bank, it will be necessary to mount the battery as well or to connect an external power supply unit (see 'Technical Specifications' for details).*

**B. FireWire Socket:** for connecting the Image Bank to a computer. In this case the computer will supply power to the unit.



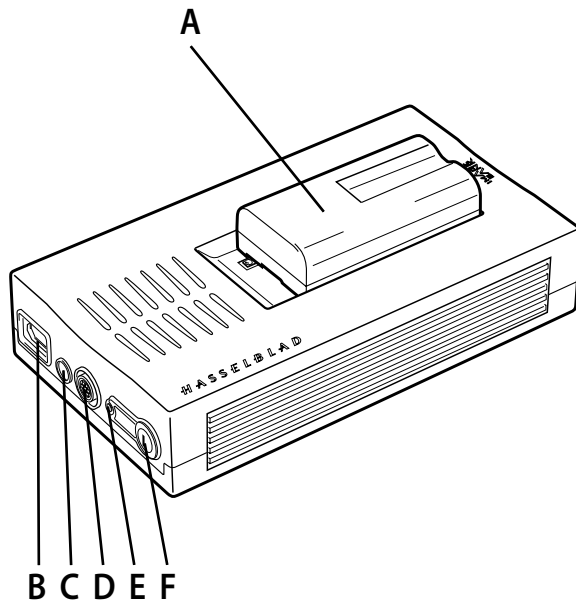

- C. **External Power Supply Socket:** plug the cable from an external power supply into this socket. See ‘Technical Specifications’ for power supply requirements.
- D. **Link connector:** This connector accepts the camera link cable, which connects to the ‘link’ connector on the camera.
- E. **Status indicator:** indicates that power is supplied to the unit. The color indicates the current status of the Image Bank: **Red** = Error, **Yellow** = Busy, and **Green** = Ready. If the indicator flashes, the battery needs recharging.
- F. **On/Off button:** switches the Image Bank and sensor unit on/off.

## Attaching/removing the battery

### Attaching the battery

To attach the battery on the Image Back follow procedure below:

1. Lower the battery into the battery compartment.



**Do not place it on top of the terminal pins!**

2. Push the battery as far as it goes towards and onto the terminal pins.

### **Removing the battery**

---



*Before removing the battery make sure that the Image Bank's hard disk is not busy - the status indicator/must be green - then switch off the unit on the On/Off button.*

Push the battery away from and off the terminal pins then lift it off.

### **Battery operation**

The Image Bank with a battery mounted in 'OFF' mode will switch to 'ON' mode when connected to the computer using the FireWire cable. When cable is unplugged the Image Bank switches to 'OFF' again.

If this causes problems for the workflow, you can switch the Image Bank to 'ON' before connecting the FireWire cable. This way the Image Bank 'remembers' that it was switched 'ON' and stays that way when the cable is disconnected.



*When the Image Bank is connected to the computer, the system is always powered from here, even with the battery connected. The battery will not be affected in any way.*

### **Battery lifetime**

---

The reference battery lifetime (for battery type NP-F550) is 1 hr 45 mins for a fully charged battery, when shooting at 10 sec. intervals, capturing half the capacity of the Image Bank (approx. 600 exposures).

If you expose with larger intervals, the battery lifetime is increased some, but the number of exposures is reduced. The other way around if intervals are decreased.

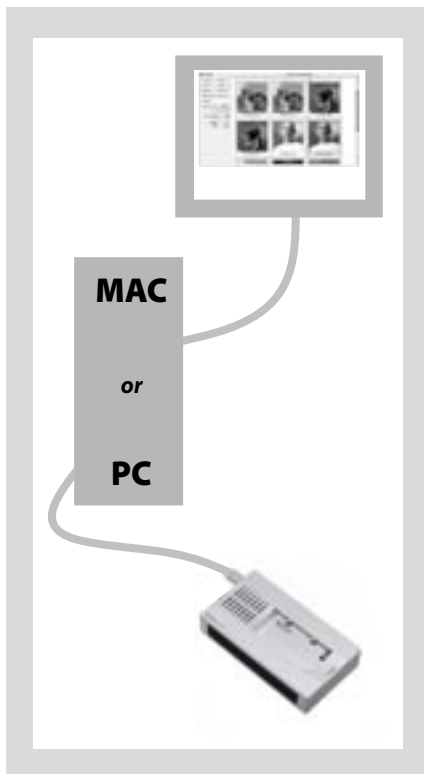

Please note that the temperature has influence on the results. At low temperatures the battery life decreases a lot. For outside shooting you should keep charged batteries in your pocket (or another warm place) to have them perform at their best.

## ***Transferring images***

All shots saved to the Image Bank's hard disk must be transferred to a computer for viewing, selecting and processing.

### ***Connecting the Image Bank to a computer***

To connect the Image Bank to a computer proceed as follows:

1. Start your computer, launch the FlexColor application and open the **Thumbnails** window.
2. Connect the Image Bank to the computer using a FireWire cable.
3. Switch on the Image Bank on the On/Off button/.
4. Within a few seconds a **Contents** window is available with thumbnails of all images ready to load.

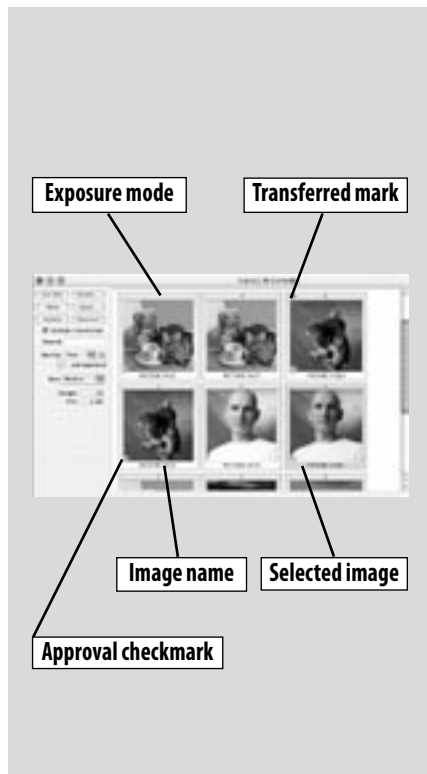

## The Contents window

The **Contents** window displays the following:

- Get Info** Displays a basic image file information window for each of the selected shots.
- Delete...** Deletes the currently selected shot(s) from the Image Bank's hard disk.
- Show** Shows the image in **FlexColor's** preview window and a transfer of the selected image to your thumbnails folder will start. Double-clicking or typing **Return** will have the same effect.
- Load...** Transfers the selected shot(s) to the currently selected **Thumbnails** folder and saves them as '3F' files.
- Update** Updates the **Contents** window with new pictures from the Image Bank.
- Approve** Approves the selected shot(s). When a shot is approved a checkmark is applied to the thumbnail.
- Sort by** Use this pop-up menu to choose whether the thumbnails should be sorted by **Date** (the order in which they were created) or by **Name**. If you wish to reverse the sorting order click the **Descending/Ascending** button to the right of the pop-up.  
Also it is possible to extend the sorting by checking the **...and approval** checkbox.
- Size** Use this pop-up menu to choose how large you would like the icons to appear in the **Contents** window.
- Images** Displays the total number of images currently stored on the Image Bank's hard disk.
- Free** Displays the free space on the Image Bank's hard disk.

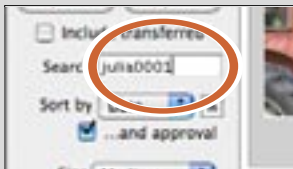

### *Image searching*

Using the **Search** field enables you to filter the **Contents** window contents. Simply enter the text you want to search for and type **Return**, and only images containing this text will be shown. To return to an unfiltered display simply delete the text from the **Search** field and type **Return**.

### *Show transferred images*

By default the **Contents** window will only show images that has not been transferred to the current thumbnails folder, but selecting the **Include transferred** option will enable you to see all stored images - in this case transferred images are marked with a small arrow in the upper left corner.

## Image transfer options

When transferring images from the Image Bank to the currently selected **Thumbnails** folder you have the following options:

### Drag and drop

Simply select a number of thumbnails in the **Contents** window and drag them to the thumbnails window.

### Show single image

Select a single image in the **Contents** window and click the **Show** button. Immediately the image will be shown in **FlexColor's** preview window and a transfer of the selected image to your thumbnails folder will start. Double-clicking or typing **Return** will have the same effect.

### Load Dialog

Using the **Load Images** dialog box gives you more control of the image transfer:

1. *Select the images you want to load and click **Load...** A **Load Images** dialog box appears:*
2. *From the **Transfer** pop-up menu choose whether you want to load **All**, **Selection Only**, or **Approved**.*
3. *Check the **Delete after transfer** checkbox if you want the shots to be deleted from the **Image Bank's** hard disk after having loaded them to the computer.*
4. *Check the **Change name** checkbox if you want the shots to be renamed while loaded - type the new name in the name field.*



5. Check the **Renumber from** checkbox if you want the shots to be renumbered while loaded - type the starting number in the number field.
6. Click **Load...**  
*The images will be transferred to and saved as '3F' files in the currently selected **Thumbnails** folder on the computer.*

### ***Tethered use (connected to a computer)***

The basic hardware requirements for the PC or Macintosh system used in connection with an H1D are as follows:

- Screen resolution of 800 x 600 pixels with true colors (24-bits).
- Mouse or other pointing device.
- FireWire interface.

For information about the processor, operating system, RAM and hard disk requirements please refer to the 'FlexColor Software Reference' manual, that comes with the FlexColor software.

The H1D is very easy to connect to a computer. Use the procedures below to set up your system.

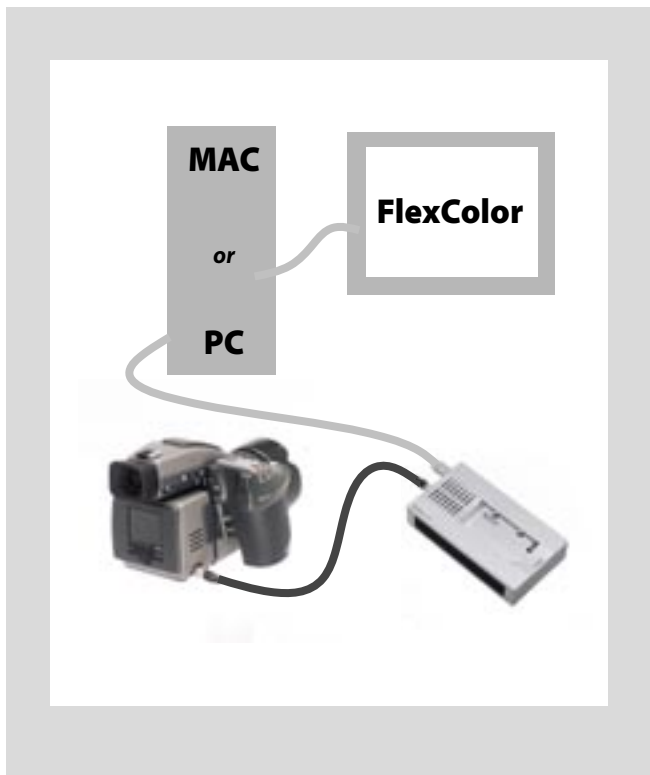

### *In the studio*

1. Connect the H1D to the Image Bank with the link cable.
2. Connect the Image Bank to the computer with the FireWire cable.



*If you are connecting the Image Bank to a computer (ex. a laptop computer) which is incapable of supplying sufficient power to the Image Bank, it will be necessary to mount the battery as well or to connect an external power supply unit- see 'Technical Specifications' for details.*

3. If needed, attach a studio-flash (strobe lighting) system to the camera body for synchronizing flash and exposure.
4. Switch on the computer.
5. If you are using a battery, press the Image Bank's On/Off button and wait until the unit is ready (status indicator = green).
6. Start the FlexColor application. See the 'FlexColor Software Reference' manual for instructions about how to use the software.









## **Untethered use (on location)**

1. Connect the H1D to the Image Bank with the link cable.
2. Attach the battery to the Image Bank (see 'Attaching/Detaching the Battery' for details).
3. If required, attach a studio-flash (strobe lighting) system to your camera body for synchronizing flash and exposure.
4. For convenience, you can attach the Image Bank to your belt or pocket using the belt clip on the rear of the device.
5. Press the Image Bank's On/Off button and wait until the unit is ready (status indicator = green).

## **Care and maintenance**

-  Always replace the protective CCD cover if the sensor unit is removed from the camera body.
-  Do not touch the exposed CCD or infrared filter with your fingers.
-  Keep all foreign objects out of the CCD opening.
-  Store the camera and Image Bank away from moisture and excessive heat - see 'Technical Specifications' for operational- and storage requirements.



*Protect your camera and Image Bank from impact.*



*Keep the original shipping boxes for storage.*

### **Cleaning the infrared filter**

If you see dark or coloured spots or lines in your images, then you may need to clean the sensor's infrared filter. In most cases, the careful use of compressed air will be adequate, but sometimes small particles will get stuck to the surface of the IR filter, requiring for a more thorough cleaning, involving either fluid or wipes. For a good safe cleaning, follow descriptions below step-by-step to obtain optimum results.

### **Removing the sensor unit**

Firstly remove the viewfinder. Slide the button on the top of the sensor unit. Maintaining pressure, press slightly on the centre of the magazine release button and twist it clockwise until it stops. Then press the button firmly inwards towards the camera body (see diag.) to finally release the unit. You can then swing it away from the body while it rests on the magazine holder. To attach the unit, position the retention groove on the unit onto the magazine support on the camera body ensuring that they are correctly positioned. Swing the unit towards the camera body and firmly press into place with a click.

### **General**

1. *Discharge any static electricity that may have built up on your body by touching the camera housing.*
2. *Remove the sensor unit from the camera body or remove the protective CCD cover.*



 **Do not remove the IR filter as this will make it virtually impossible to get the filter perfectly clean. Therefore, we strongly advise against you attempting to clean either the inside of the IR filter or the CCD surface by yourself.**

3. If you still see spots on your shot after you have cleaned the outside of the infrared filter, then you may have dust on either on the back side of the IR filter or on the CCD itself. This can only be removed at the Hasselblad factory. Contact your Hasselblad dealer for assistance.
4. Replace the protective cover or reattach the sensor unit to the camera immediately after cleaning.

#### **Cleaning using the HAMA cleaning fluid and tissues**

1. Carefully spray the fluid (Hasselblad recommends HAMA Optic Cleaning Fluid 5902) onto the IR filter at a distance of 10-15 cm (4-5 inches), so that the fluid is applied onto the filter as a thin, even haze. 1-2 sprays are enough. If you apply too little, the fluid will start to dry up before you start wiping the filter. As an alternative you can spray the fluid onto the tissue first, and then apply it to the filter as you wipe it.
2. Now fold the tissue several times to match the width of the IR filter - you may use one or more tissues at a time if necessary (to give you a better grip). Be completely sure to fold the paper so that the coated glossy side faces outwards!

 **This is the side to be used to wipe the filter - do not use the other side, as it can do more damage than good!**

3. Gently place the folded tissue onto the edge of the filter using two or three fingers. Apply firm pressure along the filter's edge to ensure equal wiping of the entire surface. Sweep

*the filter only once. Do not wipe the same area twice with the same tissue as you might reapply dirt removed in the first sweep, potentially making things worse.*

- 4. Finally check if the IR filter has been properly cleaned either by visual inspection or by mounting the camera back to the camera and making a shot. If further cleaning is needed, repeat cleaning procedure.*

### ***Cleaning with an e-wipe***

---

E-wipes are individually packed wet tissues.

- 1. Tear at the notch to break seal.*
- 2. Gently remove e-wipe from packaging and without delay begin cleaning procedure.*
- 3. Fold the tissue to match the width of the surface to be cleaned.*
- 4. Apply firm pressure using two or three fingers at the edge of the wipe to ensure evenly firm contact to filter surface - see Figure 10. Wipe surface in one unbroken motion. Note! Do not use same side of the e-wipe twice as you will be likely to reapply any particles removed in the first pass, potentially damaging the filter.*
- 5. Finally check if the IR filter has been properly cleaned either by visual inspection or by mounting the camera back to the camera and making a shot. If further cleaning is needed, repeat cleaning procedure.*

### ***Cleaning the housings***

---

If the sensor unit or Image Bank housings becomes dirty, clean them with a soft, clean cloth lightly moistened with water only. Do not use any other solvents on the sensor unit. Do not allow water to get inside the devices.

**3**

## Camera Body

- Aluminium cast in one piece
- Stainless steel shell
- Integral Quick coupling plate
- Digitally controlled
- Upgradeable software
- Modular design
- Integral ergonomic grip
- Pixel based LCD user interface

# H1D



The H1 camera body is a robust construction of cast aluminium with a stainless steel shell for extreme durability. The workings of the camera are controlled by silicon chips that provide tremendous opportunities for sophisticated operation. To take just two examples, the mirror return is slowed down at the last moment by controlling the motor to decrease vibrations and the current usage of the camera, lenses, film magazines, etc is recorded and freely accessible for service intervals, etc.

The integral ergonomic grip houses the main control interface and also contains the battery holder. An auxiliary shutter in the rear opening of the camera body protects the film from exposure during the various camera procedures. Please take extra care when handling the camera body without protective cover or magazine in place to protect the auxiliary shutter. Likewise, the front opening of the camera body reveals the mirror when unprotected by a cover or lens. Do not touch or attempt to clean the mirror. Slight marks or some dust particles on the mirror will not affect results. More noticeable problems, however, should be taken care of by a Hasselblad Authorized Service Center. The camera body also contains the viewfinder screen, which can be easily removed or exchanged without the use of special tools or adjustment procedures.

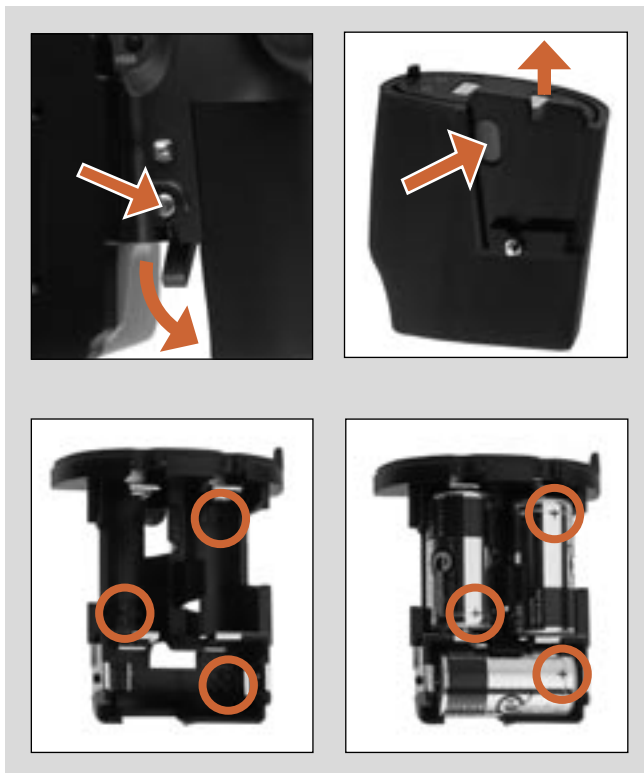

### **Carrying strap**

The carrying strap is attached by firstly withdrawing the safety collar. The hook is then freed and attached to the strap lug. Slide back the safety collar to ensure the hook remains in the locked position.

### **Batteries**

The H1D requires batteries for all actions. There is no mechanical reserve facility so it is advisable to always have a spare set of batteries or exchange set if using a rechargeable battery pack. As is the case with most batteries, problems might be encountered when used in very low temperatures. In this situation it is advisable to keep an exchange set in an inside pocket, for example, to maintain them near body temperature.

The battery holder is located inside the removable part of the grip. While keeping the battery holder button depressed, swing the battery holder retaining lever downward until it stops. The battery holder will now be released from the grip. Press the red battery cassette retaining button inwards on the holder to release the battery cassette. Load three CR-123 lithium (or equivalent) into the cassette, ensuring the polarity of each battery is correctly oriented (see the '+' markings on the batteries and the cassette). Re-insert the cassette into the battery holder, ensuring that it is seated properly in place and that the red button returns fully into

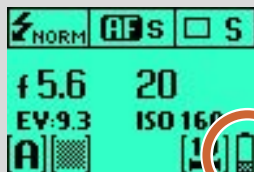

the locked position. Holding the battery holder flat against the grip and aligning the two upper lugs with the slot in the grip, slide it back into position as far as it will go. Swing back the battery holder retaining lever as far as it will go into the locked position.

Battery life is dependent on a number of variable factors and therefore cannot be exactly predicted, though the throughput of up to 2,500 exposures should be expected. If the camera is left in the active state instead of standby for long periods then naturally this figure will be reduced. However, a low-battery state is indicated as a symbol on the grip LCD. When the batteries are almost completely exhausted, a warning message 'Low battery' will appear on the grip LCD. The camera will not function at all when this message appears and battery change is essential.

The rechargeable battery pack is an optional accessory that replaces the standard battery cassette. Please see specific user manual supplied with the rechargeable battery pack for further information.

### **Viewfinder screen**

The H1D is fitted with a Spherical Acute-Matte D viewfinder screen for extreme brightness, clarity and even illumination. An optional accessory screen with a grid pattern is also available.

To change a viewfinder screen: Remove the viewfinder to access the viewfinder screen. To remove the screen, place the tip of a ballpoint pen or similar in the viewfinder screen removal lug and pull upwards. To replace the screen, position the right side of the screen in place so that it sits correctly in the recess. Place the tip of a ballpoint pen or similar in the viewfinder screen replacement indentation and press downwards until the screen snaps into position. Try to avoid touching either surface of the screen with bare fingers.



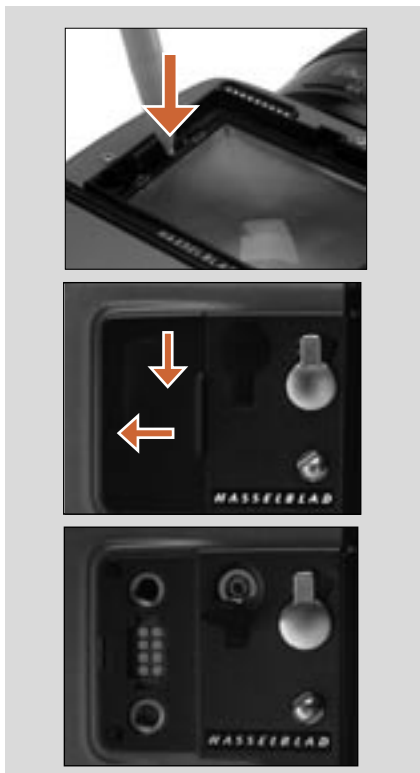

 Do not attempt to clean the screen by immersing it in water, or use any kind of cleaning fluid. If the screen becomes damp, do not use hot air to dry it. Use a soft cloth on the upper surface only. Seek advice from an Authorized Hasselblad Service Center if the screen becomes particularly soiled. Remember that particles or greasy marks on the screen might impair the viewfinder image but have no effect whatsoever on the recorded image.

### **Accessory connection**

On the left hand side of the camera body are two accessory retaining screw threads (M5), as well as a databus connector, protected beneath a cover. Various accessories, an IR-remote control for example, can be attached. The cover is removed by sliding it to the left.

### **PC-connector**

A PC connector for non TTL-flash synchronisation is located on the left side of the body. It is protected by a captive rubber



## 4

## Viewfinder

- Multi-mode light metering
- Full exposure information
- 100% image
- 90° viewing angle for eye-line composition
- Full image for spectacle wearers
- Integral diopetre adjustment
- Integral flash unit

# H1D



The 90° viewfinder provides a laterally corrected 100% image at eye-line level. It features a wide-range diopter adjustment to suit most users. The viewing distance is designed to provide full frame view even for eyeglass wearers. The bright Spherical Acute-Matte D focusing screens (located in the camera body) are interchangeable to suit preference, each of them naturally indicating the spot light metering area for accuracy in exposure estimation. The information display located beneath the viewing frame is continually updated and visible and is back lit for optimum visibility. This LCD also duplicates much information visible on the grip LCD for immediate checking. In addition to the LCD, there are four LEDs providing general warnings, flash and focus information.

The viewfinder also features a pop-up fill-flash unit for added convenience.

The viewfinder requires no batteries as it is supplied with power from the camera body and can be easily and quickly removed. Please see section on 'Flash' for full details.

See the 'Camera Body' section for details about the viewfinder screen.

The exposure compensation button and exposure mode button are described in the 'Function Control' section.

### *Parts & Components*

---

- A. Rubber eye cup
- B. Hot shoe
- C. Eyesight adjustment wheel
- D. Exposure compensation button
- E. Exposure method / mode button
- F. Integral flash unit
- G. Flash unit button
- H. Viewfinder release button

### *Attaching and removing the viewfinder*

---



While holding the viewfinder at a slight angle and resting it on the top of the camera, slide the viewfinder forward until the front locating pin is in position in the recess in the front edge of the viewfinder screen aperture on camera body. Press the rear part of the viewfinder firmly downwards until it clicks into place.

Ensure that both sides of the viewfinder are seated correctly and that it has been firmly attached. Failure to do so could cause an intermittent malfunction if the databus interface connections between the viewfinder and camera body are not positively secured.

To remove, grasp the viewfinder in the right hand and while depressing the viewfinder release button, lift the rear of the viewfinder up and away from the camera body.



### ***Eyepiece adjustment***

---

No corrective lenses are needed to adjust the eyepiece to suit most requirements. The diopter range is from -4 D to +2.5 D. Eyeglass wearers can rapidly and accurately change the settings according to whether they wish to wear eyeglasses for viewing or not.

Personal eyepiece adjustments can be carried out by pointing the camera at the sky or similar smoothly toned area. While holding the camera in your left hand, you can with your right thumb turn the adjustment wheel until the markings on the viewfinder screen reach the optimum sharpness for your eyesight.

If you normally wear eyeglasses for distance viewing and intend to wear them for camera use then do not remove them for the above procedure. If, on the other hand, you prefer to remove your eyeglasses for camera work, then repeat the above procedure without wearing your eyeglasses.

### ***Rubber eye cup***

---

Two rubber eye cups are available for the H1D. The one fitted is suitable for users who do not intend to use eyeglasses when photographing. The second shorter eye cup is for those who either prefer to position their eye further from the viewfinder and those who wish to wear eyeglasses.

The eye cups can be rapidly changed by a Hasselblad Authorized Service Center.

### ***Integral flash unit***

---

See section on 'Flash' for full details.

## 5

## Lenses

- Rapid and accurate automatic focusing capability
- Central electronic shutter
- Instant manual focus override with natural friction
- Instant automatic-focus return capability
- Non-rotation of filter or accessory when focusing
- Non-rotation of lens barrel in automatic mode
- Shutter speeds 18 hours to 1/800 sec
- Reversed lens shade serves as protection
- Automatic detection of extension rings and converters

# H1D



## Lenses

All HC lenses have been specially formulated for the H system to produce the extremely high performance expected from Hasselblad to meet the demands from conventional and digital photography alike. In addition to extreme sharpness, the design also incorporates a soft, pleasant looking *boké* (the visual quality of the out-of-focus areas of the image). All lenses feature an electronically controlled central shutter designed to extremely fine tolerances for supreme accuracy that also provides flash synchronization up to 1/800s. All lenses have a very rapid automatic focus capability with instant manual override. To ensure reliable and fast autofocus in low contrast and low light conditions, a focusing-assist light (on the grip) is automatically activated. Aperture and shutter control is set via the control wheels on the camera grip.

As a general rule, lens shades should always be fitted to achieve optimum performance. Protective filters (UV / Sky) should also be considered at least when working outdoors in harsh conditions.

### Parts & Components

- A. Lens shade index
- B. Manual focus ring
- C. Focusing distance scales
- D. Depth-of-field scales
- E. Lens index

### Attaching a lens

Remove the front protective cover on the camera body by depressing the lens release button and keeping it depressed while turning the cover counter-clockwise. Remove the rear lens cap





by unscrewing it in a counter-clockwise direction. Align the index on the lens with the index on the camera body and rotate the lens clockwise (bayonet fitting) until it clicks into place.

### ***Removing a lens***

Depress the lens release button and keep it depressed while rotating the lens counter-clockwise until it stops and lift it out. Replace protective caps on the lens immediately and on the camera body if necessary.

If you try to rotate the lens before you press the lens release button, it might lock. In this case, rotate the lens clockwise a little first and then re-attempt removal with the correct procedure: button first, then lens.

### ***Front lens cap***

Front lens caps are released for removal and attachment by inserting a thumb and index finger into the recesses and pinching in the direction of the arrows.

### ***Filters***

Filters have a screw thread fitting (67 / 77 / 95 mm, according to lens) and are screwed clockwise into place. As there is no rotation of the front section of the lens when focus is changed, filters do not rotate either. This is particularly useful when using polarizing or graduated filters where the orientation is normally critical.

### ***Lens shades***

All lenses are supplied with lens shades that additionally provide extra protection for transport and storage when mounted in reverse. Lens shades have a bayonet fitting and are turned

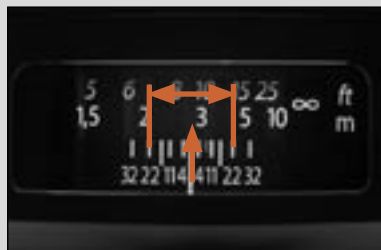

clockwise into place after ensuring the index on the lens shade aligns with the index on the front of the lens. When mounted in reverse, they are attached by matching the indexes and turning counter-clockwise.

### ***Shutter and aperture control***

Both the shutter and aperture are electronically controlled and are adjusted by the control wheels on the grip. There are no separate manual setting rings on the lenses or camera body. The chosen settings are displayed both on the grip LCD and in the viewfinder LCD. See the 'Exposure Control' chapter for a complete explanation.

### ***Depth-of-field calculation***

There are two distance scales (in feet and metres) visible through the focus distance window on the upper part of the lens barrel. There is also a central lens index mark and a depth-of-field scale. The focusing distance is read off the chosen scale from the central lens index.

Depth-of-field can be calculated as follows:

1. *Focus the lens as required.*
2. *Make an exposure reading (auto or manual) and note the aperture setting.*
3. *Find the markings on either side of the central index that correspond to the chosen aperture.*
4. *From these two markings, read off on the required lens distance scale the two corresponding distances.*
5. *The depth-of-field (at that particular aperture and focus setting) will be the area included between these two distances.*



In the illustration given here, the focusing distance is set at nearly 3 metres. At an aperture of  $f/22$ , the depth-of-field would therefore extend from just over 2 m to approx. 4.5 m.

### ***Stop down /depth-of-field***

A visual depth-of-field preview can be made by depressing the STOP DOWN button while viewing the image on the viewfinder screen.

### ***Infrared focus settings***

As infrared rays form an image at a different plane to that formed by visible light, the normal focus settings do not apply. Proceed as follows in manual focus mode:

1. *Focus the lens in the conventional manner until satisfied.*
2. *Note the distance setting against the central lens index.*
3. *Re-align this distance setting against the infrared mark (coloured red) instead of the central lens index.*

Alternatively if you have already calculated the required distance, you can make a manual distance setting by using the distance scales together with the infrared mark instead of the central lens index.

### ***Focus aid***

As well as the conventional view on the focusing screen to ensure a sharp image, the HD also features LED focus aid appearing as two arrowheads to the right of the viewfinder display (except for lenses with a maximum aperture of  $f/6.7$  or smaller). The arrowheads provide confirmation of a precision focus setting and are a useful support to a setting made with eyesight alone.



*Focus setting too far beyond the chosen distance*

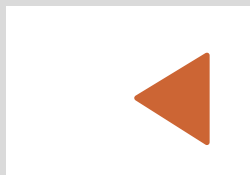

*Focus setting too close for chosen distance*

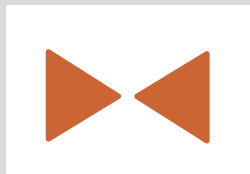

*Focus setting correct for chosen distance*

### ***Manual focus setting***

When the left arrowhead alone appears it means the focus setting is too far beyond the chosen distance (the area framed within the central zone in the viewfinder) and when the right arrowhead alone appears it means the focus setting is too close. Focus is correct when both arrowheads appear together. If the focus cannot be established, then both arrowheads flash.

### ***Automatic focus setting***

Focus is correct when both arrowheads are visible together. Focus is incorrect if only one arrowhead is visible. If the focus cannot be established, then both arrowheads flash.

6

## Film Magazine

*(optional accessory)*

- Automatic 120/220 compatibility
- Automatic wind on / wind off
- Automatic film advance
- LCD information panel
- Integral dark slide
- Customizable data imprinting
- Illuminated LCD
- Barcode recognition
- Count-up or count-down film frame reminder choice

# H1D

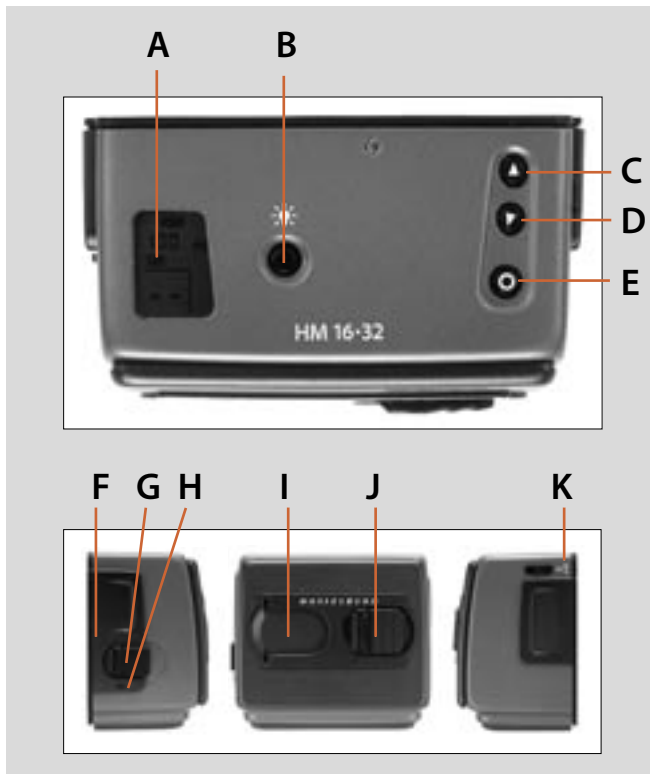

The film magazine is an optional accessory, highlighting again the great advantages of the modular system. A film magazine does not only function simply as back up for a depleted Image Bank battery on location. It can also be used where long exposures are a necessity, where temperature extremes exceed the working range of the sensor unit or perhaps where specific film emulsions are required, infrared for instance, or where certain film/processing combinations are favoured for special effects.

The film magazine is a sophisticated semi-independent unit within the modular system. It has its own power supply for individual information storage, LCD panel, illumination, etc.

Much information is transmitted and received between the magazine and the camera body, so ensure the databus connection is kept clean and not damaged in any way. It is advisable to fit the magazine protective cover when storing a film magazine to protect both the databus connection and the darkslide.

## Parts and components

- A. LCD panel
- B. LCD illumination button
- C. Change up button
- D. Change down button
- E. Function selector
- F. Film plane index



- G. Darkslide indicator
- H. Darkslide key
- I. Film tab holder
- J. Film holder key
- K. Magazine settings lock

### *LCD panel*

A

The various functions are accessed by repeatedly pressing the function selector button (loop menu) and changes made by the 'change-up' and 'change-down' buttons. Any settings are automatically saved. At very low temperatures the LCD will require a few seconds to display new settings.

### *LCD illumination button*

B

The LCD can be illuminated by pressing the display illumination button, which is accessible when the magazine is not attached to the camera. The LCD will remain illuminated all the time you keep the button depressed, up to a maximum of 10 seconds. After 10 seconds has expired, you must release the pressure on the button and press again to obtain a further 10 second period of illumination. Remember that using the illumination function very often will noticeably shorten the life of the battery in the magazine.

When the magazine is attached to the camera, the button on the magazine is inaccessible but you can still illuminate the LCD by pressing the illumination button on the grip instead.

### *Change up button* ▲

C

Can alter the settings 'upwards'. For example, to increase the film speed setting. Toggle action.



F G H

**The darkslide is closed.**

### Change down button

**D**

Can alter the settings 'downwards'. For example, to decrease the film speed setting. Toggle action.

### Function selector

**E**

Selects the four functions that can be changed on the magazine. The functions are on a menu loop so that repeated pressing of the selector button will successively access all functions in turn. After a time-out of five seconds of non-activity, the display returns to the standard screen.

 Changes can only be made when the settings lock switch is in the unlocked position.

### Film plane index

**F**

Provides a measuring point for the actual position of the film plane in the magazine. Sometimes used for calculations in critical applications.

### Darkslide indicator

**G**

Indicates whether the darkslide is in place or withdrawn:

<b>RED</b>	=	<b>stop!</b>	=	<i>exposure CANNOT be made (magazine can be removed from camera)</i>
<b>WHITE</b>	=	<b>ok!</b>	=	<i>exposure CAN be made (magazine cannot be removed from camera)</i>





I

J

K

If you attempt to make an exposure with the darkslide is closed, however, you will receive a warning message in the viewfinder and grip LCDs – ‘The darkslide is closed’.

### **Darkslide key**

**H**

Withdraws and replaces the darkslide. Fold out the key and turn it counter-clockwise 360° (towards the open  $\text{⊗}$  symbol) to withdraw it and clockwise 360° (towards the closed  $\text{⊕}$  symbol) to replace it.

 *The darkslide can only be withdrawn when the magazine is attached to the camera.*

### **Film tab holder**

**I**

Holds an ID tab from the film roll pack as a reminder of the type of film loaded. Don't forget to change it if you change film type!

### **Film holder key**

**J**

Secures the film holder in the magazine. Fold out the key and turn counter-clockwise 90° to remove the film holder and turn clockwise 90° to lock the film holder in place.

### **Magazine settings lock**

**K**

All settings can be locked to avoid inadvertent changes. To change the settings, slide the settings lock (see diag) to the right until it stops. After the changes have been made, slide the settings lock to the left (see symbol on magazine) again to secure the new settings.

### **Databus interface**

Data interface between magazine and camera. Ensure the contacts are kept clean and pro-



ected from damage. Keep the protective cover on when the magazine is being stored or transported.

## Operation

### Battery

The magazine uses a battery to retain information and settings when unattached from the camera. When attached to the camera body, the magazine takes its power requirements from the camera batteries. The magazine battery will normally be effective for 1-2 years depending on use (off camera illumination, for example).

When the battery is in a very low condition, (approx. 1 month of use left), a low-battery symbol appears on the magazine LCD as a warning.

The magazine will continue to function with no battery power left as long as it remains attached to the camera body. However, when detached, the settings will not be stored.

### Battery replacement

Release the film holder by folding out the film holder key and rotating it 90° in a counter-clockwise direction. Withdraw the film holder completely. On the bottom plate on the inside of the film magazine housing you will find a slotted circular battery cover. Insert a small coin or similar into the slot and rotate the cover about 20° in a counter-clockwise direction. The cover will be freed and the battery can be removed. Replace with a fresh CR2032 / 3V lithium (or equivalent) battery. Observe the polarity and ensure the positive (+) face is uppermost and replace the cover (ensure the retaining lugs are inserted in the battery compartment slots), locking it into place by rotating it in a clockwise direction until it stops. If you inadvertently



insert the battery incorrectly, the film magazine will not be damaged though it will not function. Try to avoid touching the surface of the battery with your bare fingers as sweat residue can decrease the electrical conductivity of the battery casing and might cause corrosion. After battery replacement, the magazine's parameters return to the default settings (Barcode, 120, Data-on, Count up).

### ***Attaching and removing the magazine***

You cannot remove a magazine from the camera body if the magazine darkslide is not in place, (when the magazine darkslide indicator on the magazine shows white). Neither can you withdraw the magazine darkslide when the magazine is not attached to the camera. Both these restrictions therefore prevent accidental film loss caused by fogging.

#### ***Attachment***



Position the magazine retention groove onto the magazine support on the camera body ensuring that they are correctly positioned. Swing the magazine towards the camera body and firmly press into place with a click. If there is resistance, the magazine retaining catch on the camera has probably been inadvertently released. In that case, push the release button again to reset the catch.

You can attach and remove the magazine with or without the film holder in place. If you just want to change to a new film, you can remove and reload the film holder without having to remove the whole magazine.

#### ***Removal***

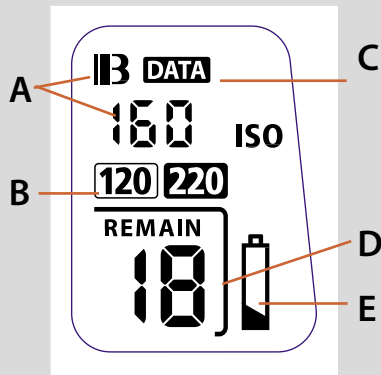
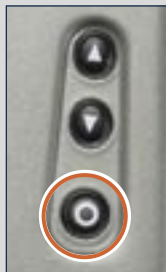
Ensure that the darkslide indicator on the magazine shows red (signifying that the darkslide is closed). Firstly press slightly on the centre of the magazine release button and twist it clockwise until it stops. Then press the button firmly inwards towards the camera body (see diag.) to finally release the magazine.



-  Ensure you press on the centre of the button, not on the lever.
-  You cannot remove a magazine if the darkslide is not closed.
-  If the film holder is inadvertently removed mid-film, then exposed frames will naturally be lost due to light fogging. However, if the film holder is quickly re-inserted, the film will automatically be advanced by three frames to position fresh unexposed film. The film counter will also correspondingly add on three frames to the original number recorded before the film holder was removed.

## Magazine settings

Press the  button repeatedly to successively access:

- A. Film speed (ISO / Bar Code)
- B. Film length (120/220/ Number of frames)
- C. Data (on/off)
- D. Frame counter (count down / count up)

### Film speed setting / Barcode

A

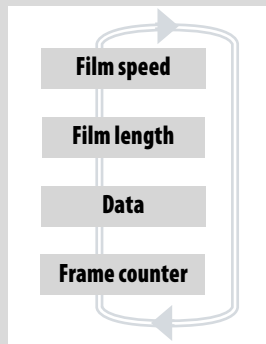

The film speed (ISO / ASA) can be set automatically or manually. Automatic setting uses a Barcode (only some films have this feature). This is the default setting.

-  Film settings (ISO / film length) are automatic only if the magazine is set at Barcode automatic. That is, a barcoded film cannot override a manual film speed setting but a manual setting can override the film speed of a barcoded film.



Films without a barcode must have their speed set manually. A manual setting must also be made if you want to override the speed setting of a barcoded film.

To access Manual setting:

- 1) Ensure the LCD settings lock is in the unlocked position.
- 2) Press the  button until a figure (or barcode symbol) appears together with ISO.
- 3) Press either the  or the  button to reach the required setting.
- 4) The new setting will be saved automatically after a time out of five seconds.
- 5) Return the LCD settings lock to the locked position.

 If you use both standard and barcoded films (or overridden barcoded films), check that you have changed the settings accordingly.

### Film length/number of frames



**B**

Both 120 and 220 films can be used. 120 film will produce 8 (for use with 'half-length' 120 films only) or 16 frames and 220 film will produce 32 frames.

If the film has a barcode, then film length setting (and film speed setting) is automatic. The LCD will automatically show the barcode symbol and the appropriate film length. (Note that film speed can be overridden with barcoded films, but not film length).

If, however, the film has no bar code then proceed as follows:

To access film type setting:

- 1) Ensure the magazine settings lock is in the unlocked position.
- 2) Press the  button until the 120 or 220 symbol appears.
- 3) Press either the  or the  button to change the desired setting (not possible at barcode setting).

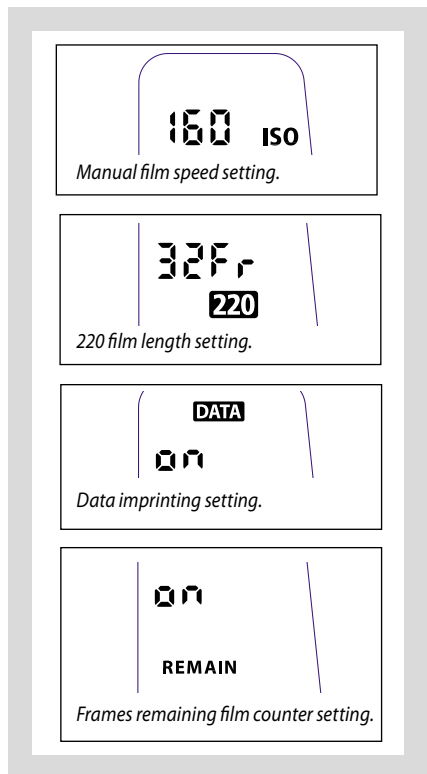

4) The new setting will be saved automatically after timeout.



5) Return the magazine settings lock to the locked position.

### Data imprint setting

C

Data imprinting can be activated or deactivated through the magazine menu.

To access data setting:

- 1) Ensure the magazine settings lock is in the unlocked position.
- 2) Press the  button until the Data symbol appears.
- 3) Press either the  or the  button to reach On or Off.
- 4) The new setting will be saved automatically after a time out of five seconds.
- 5) Return the magazine settings lock to the locked position.

Operation and changes made to the data imprinting function are accessed through the camera menu. Please see separate section for full details.

### Frame counter setting

D

The frame counter can be set to show either how many unexposed frames remain on a film or how many frames have already been exposed. The LCD shows your choice of setting by adding the word Remain as a reminder of the number of frames **remaining** or 'countdown'. Absence of this word implies the opposite, namely, 'count-up', so it denotes the number of the next frame to be used (for example, the figure 4 means three frames have already been exposed). This information is also automatically displayed on the grip LCD and viewfinder LCD though only as a figure above a symbol.

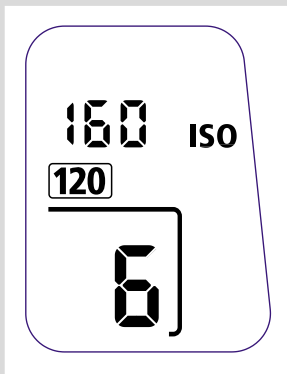

To access frame counter setting:

- 1) Ensure the magazine settings lock is in the unlocked position.
- 2) Press the **⊙** button until Remain appears.
- 3) Press either the **▼** button or the **▲** button to reach the desired setting (toggle function).  
     'ON' will show the number of frames **remaining**  
     'oFF' will show the number of the next frame.
- 4) The new setting will be saved automatically after a time out of five seconds.
- 5) Return the magazine settings lock to the locked position.

### Low-battery symbol

E

The low-battery symbol only appears on the magazine LCD when the battery needs changing.

### Example

In the example shown here:

- 120 film length set manually
- the film speed (ISO160) has been set manually
- 5 frames have already been exposed (therefore with regular 120 film, 11 frames remain)
- the battery is functional

## Film loading

The film magazine can be loaded either on or off the camera. Regularly check the interior of the magazine and remove dust, particles or any scraps of paper from previous rolls of film. Load and unload film magazines away from direct light sources.

- 1) Fold out the film holder key and turn it counter-clockwise 90°. Withdraw the film holder completely.
- 2) Place an empty take-up spool in the upper spool holder by placing one end over the fixed stud in the holder and the other end underneath the sprung spool retaining arm. Rotate the spool a little if necessary until it clicks into position.
- 3) Completely remove the retaining paper band from a new roll of film and place it in the lower spool holder. See diagram for correct orientation. Ensure you do not place the film spool the wrong way around!
- 4) Pull 8–10 cm (3–4 in.) of paper backing from the film roll and insert the tongue of the backing paper into the slot in the take-up spool. Turn the spool one complete turn to ensure the tongue is firmly held in place by the overlying paper backing.
- 5) Re-insert the film holder into the main body of the film magazine ensuring the correct orientation. Press firmly inwards towards the magazine and pay particular attention to see that both sides are level with the magazine body before turning the film holder





*key clockwise 90° to lock the film holder in place and fold the key back into its stored position. You might find that increased pressure on the left hand side of the film holder will more easily ensure a positive and correct positioning in the magazine.*

- 6) *If the camera is active or in standby mode the film will be wound automatically by the camera to position the first frame (this function can be changed in 'Custom options' so that the film is advanced only when the shutter release button is pressed the first time).*

### **Film wind off**

---

When the last frame has been exposed, the film will automatically be wound off. However, to wind off a film sooner, press the film wind off button (on the camera). Use a ballpoint pen or similar to activate it. You must also confirm the message on the grip LCD before the film rewinds.



### **Unloading a film**

---

To remove a film, remove the film holder in the same manner as when loading a film. Grip the exposed roll of film firmly and remove.

Ensure the paper backing is wound tightly and that it is sealed with the band properly (the band may need to be moistened to activate the adhesive depending on type). Store exposed films away from strong light sources and contact with sharp objects. Move the remaining empty spool to the take-up spool compartment.

## 7

## Light Metering & Exposure Control

- Three metering methods
- Five exposure methods
- Extremely accurate light metering

# H1D



## Light metering and exposure control

The light metering system is capable of selective sensitivity producing three reflective metering methods: Average, Centre weighted and Spot. All methods are measured in increments of 1/12 EV. Information transfer is rapid and automatic ensuring consistently correct exposure settings even in difficult and changeable lighting situations.

Light measurement is made through the lens (TTL) by the AE viewfinder and exposure is controlled manually or automatically by the control wheels and/or settings. The information is visible on both the grip LCD and the viewfinder LCD. A great deal of control is available ranging from 100% manual through to sophisticated fully automatic by way of the various exposure methods: Manual, Aperture priority, Shutter priority, Program and Program variable.

Two primary factors have to be considered when making exposure control choice, namely, metering method and exposure mode:

Metering method determines in which manner the light measurement is made and how much of the image is taken into account (Average, Centre Weighted and Spot).

Exposure method involves the parameters and deciding factors about how the light measurement is translated into aperture and shutter speeds. Here the choice is about the camera controls and their effect on the result or suitability for the subject. Included in this choice is the type of automation too (Manual for 100% user control, Aperture priority, Program, etc for automated control).

Some methods and modes are much more suited to various situations and applications than others, while some depend to a greater degree on personal preference and ways of working. A discussion of the points to consider in this context is beyond the scope of this manual. If you



Manual



Centre weighted

are not sure about choice, please check in a photographic textbook for a fuller explanation. Also check our website occasionally – [www.hasselblad.com](http://www.hasselblad.com) – for articles and discussions concerning such matters.

Remember that exposure configurations are only applicable to the speed of the film in use. Ensure you have the correct setting on the film magazine!

Since the light measuring system is TTL, filter factors, lens extension / extension ring factors, etc, are automatically taken into account for average purposes. However, some combinations of methods and equipment can cause slight discrepancies for various reasons and therefore for critical work you should make alternative exposures to suit personal preference.



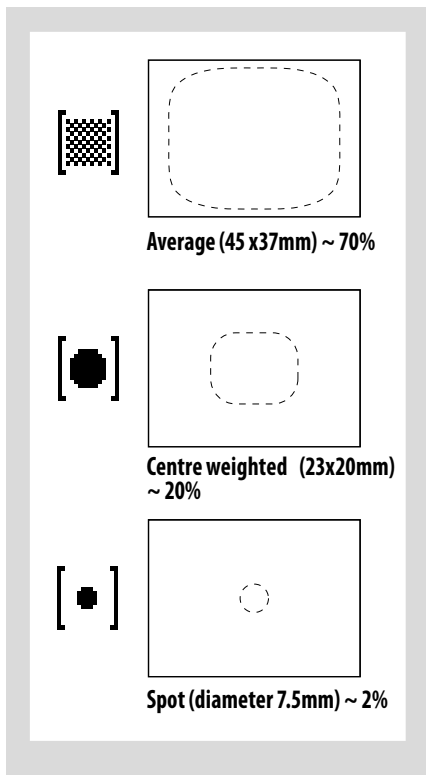

Exposures are displayed on the grip LCD to within 1, 1/2 and 1/3 EV tolerances (dependent on setting). This means that 'half-stops' are shown in a form that can differ from more traditional displays. For example, the position between f/8 and f/11 is displayed as f9.5 and likewise the position between 1/30s and 1/60s is displayed as 45. Therefore a display showing 'f9.5 45' simply means 'f/9.5 at 1/45 second'. The appearance of an 's' after the shutter speed signifies whole seconds so, for example, '45s' on the display signifies an exposure time of 45 seconds, not 1/45.



## Metering method

There are three metering methods available. All three are reflective methods (measuring the light reflected off various selected parts of the subject according to method) and are through the lens (TTL). These have the following designations (with their respective LCD symbols):

-  — Average
-  — Centre weighted
-  — Spot

**Average:** Commonly used for 'average' light situations where there is no particular dominance of light or dark areas across the tonal range. Takes into account approximately 70% of the image seen in the viewfinder.

**Centre weighted:** Emphasises the central section of the focusing screen equivalent to approximately 20% of the image. This provides a balanced assessment and is a typical choice where the main subject is in the centre of the image.

**Spot:** The sensitive area is equivalent to approximately 2% of the image area (the central spot on the viewfinder screen). Any parts of the image outside of this area will not affect the exposure reading. This provides a very accurate measurement of specific tones. Typically used in the zone system and similar light measuring situations where maximum control is required. Also excellent for tonal comparison measurements. The spot mode can display 'zones' instead of EVs in the viewfinder LCD (see Camera Options).

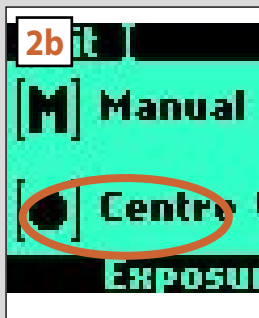

### Selecting metering method

Proceed as follows with the camera in active mode:

1. Press the **EXP** button on the viewfinder.
2. Turn the rear control wheel (in either direction 2a) to successively access the three choices: **Average**, **Centre Weighted**, and **Spot 2b**.
3. Press **Save** (**DRIVE** button) to retain the setting.

### Exposure method

Exposure can be controlled either manually or by using one of four automatic modes. These have the following designations on the grip LCD:

- M – Manual
- A – Aperture (priority)
- S – Shutter (priority)
- P – Program
- Pv – Program variable

In each mode you can see both the aperture and the shutter speed information on the grip LCD and on the viewfinder LCD.

In manual mode, aperture is set by the front control wheel and the shutter speed by the rear control wheel.

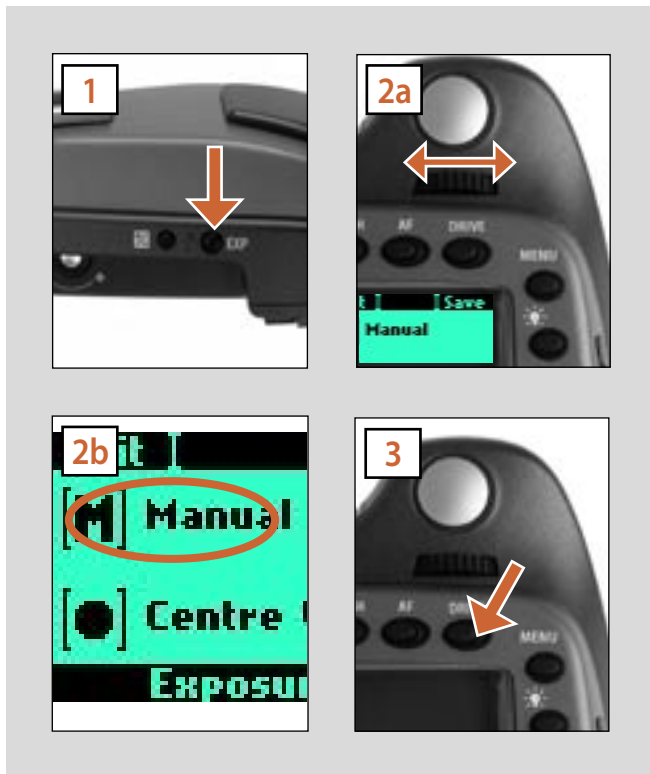

In the automatic modes, the aperture and shutter speed settings are controlled by the camera, either partially or completely according to setting. Within this mode there are four choices. (Please see the Appendix for P and Pv mode charts that describe the aperture and shutter speed setting combinations).

### MANUAL EXPOSURE — M

Manual mode will provide total user control of the shutter and aperture settings.

To set Manual, proceed as follows with the camera in active mode:

- 1) Press the **EXP** button on the viewfinder.
- 2) Turn the front control wheel (either direction 2a) until you reach **M (Manual)** 2b.
- 3) Press **Save (DRIVE button)** to retain the setting.

In this mode the shutter speed and aperture settings are manually chosen by turning the front and rear control wheels.

The standard exposure setting is obtained when the pointer over the exposure scale is positioned above the central index (in the viewfinder LCD).

Any deviation from this standard setting is displayed by:

- *the pointer appearing elsewhere than above the central index and*



+0.3  
..... f6.8 0.3s

- *by figures above the scale representing the amount of adjustment in EVs.*

A '+ 0.3' above the scale in the display, for example, would indicate a '0.3 EV overexposure' setting. Conversely, a '-2', for example, would indicate a '2EV underexposure' setting. Note that the appearance of a +/- symbol on the grip and viewfinder LCDs in manual mode means that a change has been made to the exposure compensation setting.

The actual aperture settings and shutter speeds are indicated to the right of the exposure scale in the conventional manner. (Note: 'full-stops', 'half-stops' and 'third-stops' are also displayed, according to setting (see 'increment setting'). For example, a setting between f/8 and f/11 will appear as f/9,5 if 'half-stop' is chosen).

The **B** shutter speed position is active and therefore consumes battery power. The **T** shutter speed position, however, is equivalent to the standby mode regarding battery consumption. For exposures longer than five minutes, use the long exposure setting instead that automatically activates the standby mode after 4 minutes.

### **AUTOMATIC EXPOSURE — A, S, P, Pv**

Automatic exposure provides a choice of two ways of controlling shutter speed and aperture settings semi-automatically and two ways fully automatically:

**Aperture priority: A** - The aperture is manually chosen by you by turning the front control wheel, and the shutter speed is automatically chosen by the camera.

**Shutter priority: S** - The shutter speed is manually chosen by you by turning the front control wheel, and the aperture is automatically chosen by the camera.

**Programmed: P** - In this mode, an aperture / shutter combination is chosen by the camera according to the EV measured (metering method remains as your choice), though only within pre-set appropriate limitations to suit various requirements and applications.

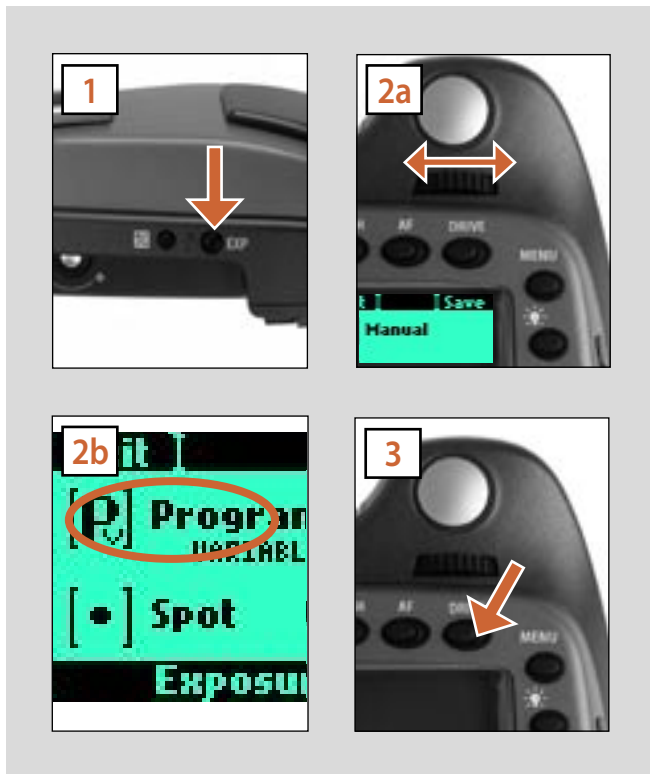

**Programmed variable: Pv** - This mode is very similar to Programmed, except with the additional parameters of lens focal length being automatically taken into account. For example, long shutter speeds will automatically be avoided with a long focal length lens.

To set one of the modes, proceed as follows with the camera in active mode:

- 1) Press the EXP button on the viewfinder.
- 2) Turn the front control wheel 2a (either direction) until you reach the required setting 2b.
- 3) Press Save (DRIVE button) to retain the setting.

In Automatic mode the front control wheel selects alternate combinations while maintaining the same EV and the rear control wheel alters the amount of exposure compensation. The compensation appears in the same manner as the Manual setting plus the appearance of a +/- symbol on both the grip and viewfinder LCDs. Note that the appearance of a +/- symbol on both the viewfinder LCD regardless of rear control wheel position means that a change has been made to the exposure compensation setting.

### AE-L button

This button has two main functions that can be incorporated in various working methods involving exposure lock. It also has an extra function for the flash meter capability (see AE-L section under Flash). The AE-L button can:



a) lock an EV setting in manual and automatic modes.

b) be used in Zone mode.

a) When the button is pressed, the light metering facility is locked to the EV setting at that moment. An **L** (= locked) symbol appears between the shutter speed and the aperture indication on the grip LCD and viewfinder LCD to confirm the status. Press the **AE-L** button again to unlock (toggle function).

In the locked setting, the aperture and shutter speed become interlocked. In this way, a new aperture/shutter combination that still represents the same EV, can be rapidly chosen. For example, if you set the shutter at 1/125s and the aperture at f/8 and lock them together, you can access new EV-equivalent combinations of, for example, 1/30s at f/16 or 1/500s at f/4 just by moving the front control wheel.

In practice this means you could, for example, in auto mode, position the metering area (spot setting) over an area in the subject that you determine to be equivalent to a mid-grey and lock it with the **AE-L** button. You can then re compose the picture with the metering zone positioned over an area much brighter or darker while still retaining the original exposure setting and choose a new combination of aperture and shutter speed settings.

b) The **AE-L** button also allows the spot metering function to make tonal comparison readings and brightness range checks. Press the **AE-L** button to lock the EV setting. In this way, the metered area is saved as a mid-grey (Zone V), the marker above the viewfinder exposure scale displays the amount of over- or under deviation (from the original mid-grey setting) the metering zone is reading at that moment in EVs. The amount of compensation appears on the grip LCD and in the viewfinder LCD as EVs.

If you have chosen **Spot** together with **Zone** display (see Custom options) as well as one of the automatic modes **A**, **S**, **P** or **Pv**, point the spot marking at an area that you decide should be a

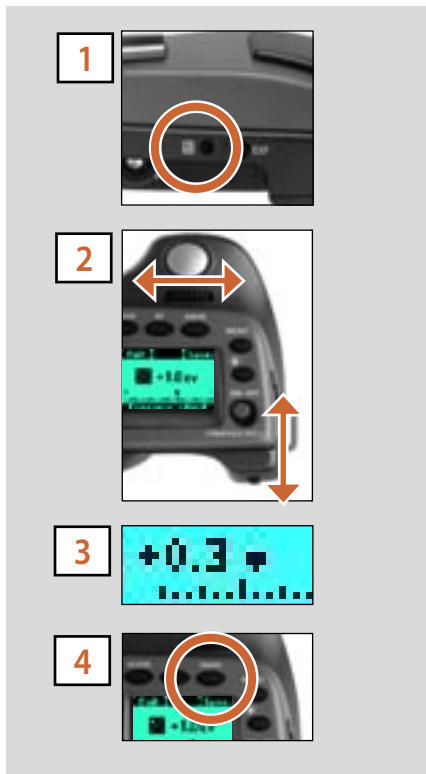

Zone 5 and click the **AE-L** button. The meter will now display different parts of the subject as zone values in the viewfinder LCD as you move the spot marking over the subject. (Included are **Lo** and **Hi** to signify areas beyond the range of the film).

Alternatively you can choose to re-classify an area as another zone and then check the rest of the subject to see how other areas fall appear on the zone scale. Do this by following the above procedure and then turning the rear control wheel until you see the new desired zone value in the viewfinder LCD. You will also see the new exposure (changes will be according to whether it is Aperture Shutter priority) that will now produce that new zone. For example, you might have measured a rock at zone 5 but wish to make it darker. By moving the rear control wheel you could re-classify it as zone 4. In the same setting you will then also be able to see how the rest of the subject appears on the zone scale.

Alternatively, you can also pre-set the initial zone reading in order to save time and effort where there is no freely available 'zone 5' subject for light measuring. For example, you might be on a sandy beach where you know that sand is normally classified as zone 6. You can pre-programme the zone placement by holding down the **AE-L** button while choosing the new zone value by turning the front control wheel. Pointing the camera at other parts of the scene will now display their zone values (in relation to the initial setting of sand at zone 6) to see whether they still lie within the range of the film and how they might appear in the result (aside from film development considerations). See under Zone in the Appendix for further information about the zone system.

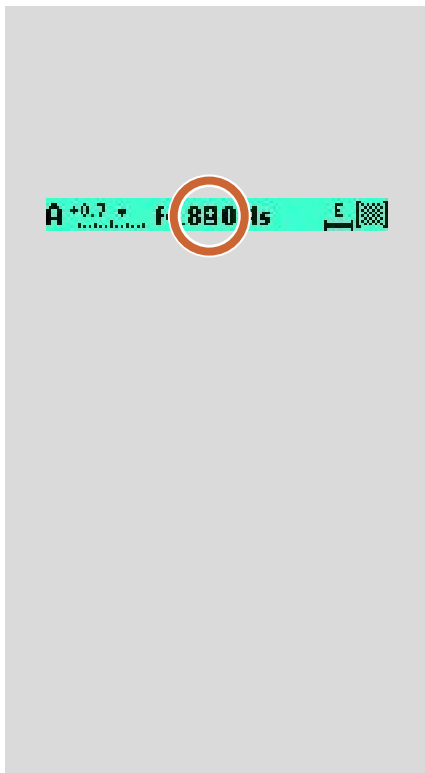

### **Exposure compensation**

The exposure compensation facility, for both manual and automatic modes can be set from -5 to +5 EV, in 1/3 EV increments. This facility will adjust the exposures by the set amount until changed and the setting is visible above the scale in the viewfinder and as a  $\pm$  symbol on the grip LCD.

*To make a fixed exposure compensation setting, proceed as follows with the camera in active mode:*

- 1) Press the +/- button on the viewfinder.
- 2) Turn either the front or rear control wheels to increase or decrease the amount of compensation in 1/3 EV steps.
- 3) The amount is displayed in the viewfinder as both an EV figure complete with a - or + prefix, and as a marker above a - to + scale with central index.
- 4) Press **Save (DRIVE button)** to retain the setting. A  $\pm$  symbol is then displayed between the aperture and shutter speed setting as confirmation of the setting.



## 8

## General Functions

- Manual and autofocus modes
- Three drive modes
- Quick adjust wheel
- User Profiles

# H1D



## Power

The camera can be set at two active power modes **ON** or **Standby** as well as **OFF**. In active modes, battery consumption is least in Standby mode and most in ON mode. The camera enters Standby mode automatically after 15 seconds (default) to preserve battery consumption but this interval can be changed in Custom Options. Settings can only be made when the camera is in the **ON** mode.

### ON

To activate the camera press the red **ON/OFF** button until you see the start-up H1D logo appear on the grip LCD. The logo is automatically followed by the standard screen. The camera is now in **ON** mode.

After a set period of inactivity (programmable in Custom Options) the camera automatically enters Standby mode, signalled by the appearance of the H1D logo again.

### Standby

In this mode the camera is in a mainly inactive 'standby' mode and is ready to be immediately reactivated to the **ON** mode by:

- *pressing the shutter release button half way*
- *pressing the stop down button*
- *clicking the ON/OFF button*
- *pressing the Mirror up button.*

In this mode, signalled by the standby H1D logo appearing on the grip LCD, the demand on the batteries is very low. It is ideal for general use where intervals between shots exceed a few seconds.





Standby mode is automatically set from the ON mode after 15 seconds (default) of inactive use (programmable in Custom Options). OFF mode is also automatically set after several hours of inactivity.

### OFF

Press the red **ON.OFF** button for a half second. All buttons (except the **ON.OFF** button) remain ineffective, producing minimal demand on the batteries. This is the normal mode when transporting or storing the camera or where there might be a risk of inadvertently activating the camera. (However, remove the batteries if you are going to store the camera for a period of more than a few weeks).

In this mode neither the viewfinder LCD nor grip LCD information is available. The magazine LCD, however, will continue to display information as it is independently powered.

**OFF** mode is automatically set after six hours of inactivity.

## Manual focus

*There is both a **Manual Focus** mode setting and a **Manual Override** capability. Manual focus is a specific setting that you actively make, whereas manual override is always available as a temporary override of an autofocus setting.*

*In **Manual Focus** mode, focusing is carried out by rotating the focusing ring in the conventional manner. The focus setting remains until changed as with a conventional non-autofocus lens. This means that pressing the shutter release button will not activate a focus setting change as it does in autofocus. To change back to autofocus, you must make a new setting (by pressing the AF button and choosing AF S or AF C).*

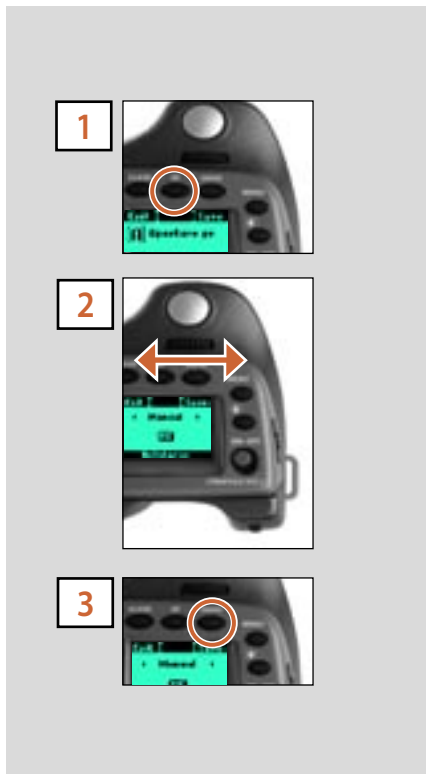

With **Manual Override**, you can manually alter a focus setting that has been made in the autofocus mode, by rotating the lens barrel in the conventional manner and without having to change modes. As long as the shutter release button is kept at the half-press position, the new focus setting is maintained. By releasing the pressure on the shutter release button and pressing again, the autofocus function is immediately reactivated.

### Manual focus mode

The **Manual focus mode** is set by the front control wheel on the grip in the following manner:

*In camera active mode:*

- 1) Press the **AF** button on the grip.
- 2) Turn the front control wheel to: **Manual**
- 3) Press **Save** to store the setting.

 You can also use the shutter release button 'half-press' function to save a new setting and automatically return to the standard screen.

### Manual override in autofocus mode

Manual override is always possible in automatic focus mode without any need to make a new setting; just rotate the focusing ring in the conventional manner. As the lens barrel does not rotate in autofocus mode, you can hold the focusing ring for instant manual adjustments as you would with a conventional lens. However, to retain the new manual focus adjustments, you must maintain the pressure on the shutter release button. You can instantly return to the automatic focusing mode by releasing the pressure on the shutter release button first and then pressing the release button halfway again.

The instant manual override facility produces a convenient way of working. You can take advantage of autofocus while retaining an instantly adjustable manual focus check if preferred for pin-point accuracy without making any changes in the settings.

Natural friction is inherent in the design to purposely reproduce the secure feel of a manual lens.

Please note that when focusing manually, the infinity and closest distance marks on the lens scale can appear to be positioned beyond the central index. This is only an apparent effect and does not change the focusing range of the lens.

## Autofocus

*Autofocus mode can be either **Single Shot** or **Continuous** and is activated by pressing the shutter release to the half-press position. Its operative range from EV1 - 19 at ISO100. The point of focus is determined by the area within the central rectangular zone on the focusing screen. When light levels are too low or the contrast of the subject is too low, auxiliary illumination (situated on the top of the grip) is automatically activated if desired. The operative distance is approximately six metres from the camera. Alternatively, a suitable attached flash unit that has a similar facility ( a Metz 54/70, for example) can also be used instead. This feature can be altered in settings; see under Custom options/AF assist light.*

### Single Shot

In **Single Shot** setting (**AF S**), the shutter release will be blocked until the camera finds the optimum focus setting. This ensures that no exposures can be made that are not finely focused. However, this delay will normally be only a fraction of a second in good lighting conditions with a clear focusing pattern.





Note though that in this mode the lens will focus at a distance and will remain focused at that distance while pressure remains on the shutter release button. In this way, you can focus on a nearby object for example, temporarily positioned within the focusing zone on the viewing screen and then without releasing pressure on the shutter release button, recompose knowing that the focus remains on the object chosen even though it is now outside the focusing zone. Releasing the pressure on the shutter release button and pressing again half way would now change the focus setting to the distance of the object within the focusing zone.

Another method for users who prefer more manual focus control while maintaining the benefits of the accuracy of autofocus is to set the camera to Manual focus and the User button to AF drive (see 'User button function list'). Focus is then adjusted manually with the focusing ring but when the User button is pressed, the autofocus facility temporarily operates in AF S mode. After the new focus adjustment check has been made automatically, the camera reverts immediately to manual focus control when the User button is released. Therefore, you can recompose the picture without having to maintain pressure on the release button in order to retain the newly automatically made focus setting.

When using macro lenses or tele lenses you may find it convenient to restrict the amount of searching the lens will do to find the perfect focus. When working close-up with a macro lens, for example, it is of little use that lens will search in the infinity range. To speed up focusing therefore, you can restrict the lens scanning range to **Full scan**, **Near scan** and **Infinite scan**. These are chosen using the rear control wheel.



## Continuous

In **Continuous** setting (**AF C**), the shutter can be released rapidly before the lens is focused in order to capture a split-second shot (in **Single Shot**, an exposure cannot be made until the camera has had time to focus). However, the camera will continue to focus if a moving subject is within the focusing zone or if you recompose, even though the shutter release button is half pressed.

One method to exploit this feature when photographing in a rapidly changing situation such as photojournalism, for example, is to keep the shutter release button pressed down. In this way the lens focuses constantly (according to the focusing zone) and by momentarily releasing the pressure on the shutter release and then immediately pressing again, you minimize the amount of time needed for the lens to check focus, thus ensuring a split-second shot at optimum focus.

## Autofocus mode

*Autofocus is set via the control wheels in the following manner:*

*In camera active mode:*

- 1) Press the **AF** button on the grip.
- 2) Turn the front control wheel to: **Single Shot** or **Continuous** as required.
- 3) Press **Save** to store the setting.

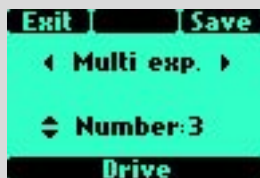

## DRIVE

There are three drive modes: **Single**, **Continuous** and **Multi exposure**. They are all accessed by pressing the **DRIVE** button on the grip.

### Single

In this mode, an exposure is made when the shutter release button is pressed, the film is advanced to the next frame and the camera is made ready for the next exposure. To make the next exposure however, you must first release the shutter release button and then press again.

*In camera active mode:*

- 1) Press the **DRIVE** button on the grip.
- 2) Turn the front control wheel to: *Single*
- 3) Press *Save* to store the setting.

### Continuous

In continuous mode, the camera automatically continues to make exposures and advance the film for the next exposure as long as you maintain pressure on the shutter release button (to the end of the film) at a rate of approximately 2 frames per second.

*In camera active mode:*

- 1) Press the **DRIVE** button on the grip.
- 2) Turn the front control wheel to: *Continuous*
- 3) Press *Save* to store the setting.



### ***Multi exposure (only active together with film magazines!)***

In multi exposure mode, the camera does not advance the film after the first exposure, only at the end of the pre-determined number of exposures. The frame options are: 2, 3, 4, 5 and 'No limit'.

*In camera active mode:*

- 1) *Press the DRIVE button on the grip.*
- 2) *Turn the front control wheel to: Multi exp.*
- 3) *Turn the rear control wheel to select the number of frames required.*
- 4) *Press Save to store the setting.*
- 5) *The LCD will display firstly that no frames have been exposed in the multi-sequence (For example, in the case of a three exposure setting the display will be Exp:0/3).*
- 6) *Press the shutter release button to make the first exposure.*
- 7) *The LCD will display how many frames have been exposed in the sequence (In the case of a three exposure setting the display will now be Exp:1/3. After the next exposure, the LCD would then display 2/3 etc)*
- 8) *You can change your mind at any time to exit the sequence by pressing the DRIVE button to advance the film to the next frame. The camera is then prepared for another new multi exposure sequence according to the initial setting.*



## PROFILES

The profiles feature allows rapid access to pre-determined combinations of settings that increase the speed and security of workflow. One example might be in a social situation where there might be a need for formal outdoor portraiture followed by informal indoor handheld flash-assisted wide-angle shots, both situations requiring very different settings in a stressful environment. By predetermining the relevant settings required beforehand for each situation, they can be saved collectively as a profile. By calling up the profile, you can then be assured that all the settings are correct without risk at the press of a button.

For example, you might choose - autofocus single, bracketing, programmed exposure, etc - for outdoors. Once set, you would click on the red **PROFILES** button, select a profile name and press **SAVE**. A new name can be entered for the new profile - 'Outdoors', for instance - and saved again. New settings are made for the indoor shots changing to flash, Pv setting, etc and the procedure repeated. By simply accessing 'Outdoors' or 'Indoors' in the profile list, all the relevant settings will be instantly and correctly implemented to match the situation.

There are four profiles: **Standard**, **Full auto**, **Studio** and **Fill flash**. All except **Standard** can be changed and renamed.

The pre-set profiles feature the following:

**Standard:** *normal flash, autofocus (single), single drive, autoexposure, average metering.*

**Full auto:** *normal flash, autofocus (single), single drive, programmed exposure, centre weighted metering.*

**Studio:** *normal flash, manual focus, single drive, manual exposure, spot metering.*





**Fill flash:** *normal flash (-1.7EV), autofocus (single), single drive, autoexposure, average metering.*

Access them by clicking on the **PROFILES** button when in the standard screen. The profile screen appears and the required profile selected by scrolling the list and loaded to implement the saved settings.

 *All user profiles can be restored to factory default settings by holding down the MENU and DRIVE buttons with the battery attached*

### Making a profile

- 1) Activate the camera and go through the various settings (for example, autofocus, aperture priority, fill flash exposure compensation, etc.) you require for the particular purpose and save them as you go.
- 2) When all the required settings have been made, click the **PROFILES** button on the grip once and the profile screen will appear.
- 3) Use either the front or rear control wheel to scroll through the list of profiles. Pick a profile name you want to change (except Standard), press **SAVE**.
- 4) The Profile name screen is then displayed where you can rename the profile to what suits you (see section Imprint / Text 4.2.2 further on in this manual for procedure details).
- 5) Press **SAVE** to keep the combination of settings with the new name.

To use a profile from the standard screen, press the **PROFILES** button to reach the profiles screen again. Scroll down the list to the profile you want and then press the **Load (AF)** button. All the saved settings will then be automatically implemented.

### ***Changing a profile name***

---

You can change a profile name (except 'Standard') at any time by clicking on the **PROFILES** button, scrolling to the desired name in the profile list and pressing the **Load** button (in order to activate the profile). Then press the **PROFILES** button again, scroll to the same profile and press the **Save** button.

The profile name screen will then appear and changes can be made and saved accordingly. (See section '4.2.2 Text' and 'Adding text/ Changing profile name' for full details).

- 1) *Press the PROFILES button and scroll through the list to the desired profile, using either the front or rear control wheels.*
- 2) *Press Load to recall the profile*
- 3) *Press the PROFILES button again*
- 4) *Press SAVE.*
- 5) *Make the desired changes by first erasing the old name and then selecting the characters for the new name. (See section '4.2.2 Text' and 'Adding text/ Changing profile name' for full details).*
- 6) *Press SAVE.*

## 9

## Advanced Features

- Programmable self timer
- Programmable bracketing
- Programmable interval setting
- 21 custom options
- Data and text imprinting

# H1D

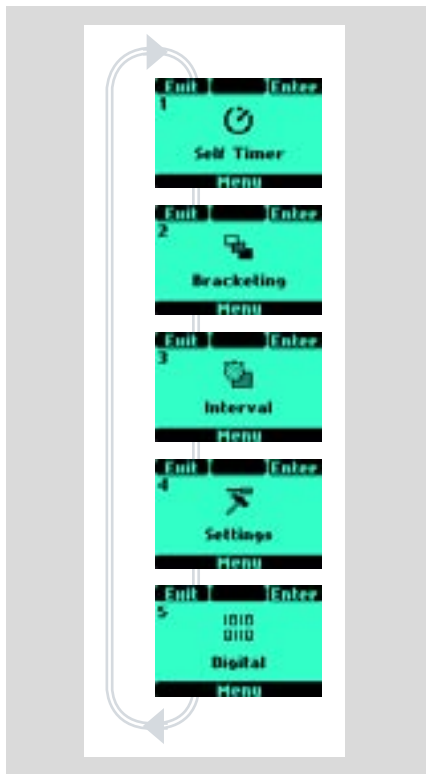

There are a number of more advanced features that while not necessarily used every day still remain immediately accessible through the menu system. They provide the integral finesses that make the H1D a powerful and sophisticated tool to satisfy a variety of professional demands.

The five main functions are:

1. Self timer
2. Bracketing
3. Interval timer
4. Settings
5. Digital

An important point to remember is that certain options are only available when the relevant screen has been accessed. For example, in Self Timer the choice of 'delay/mirror up' or 'mirror up/delay' is only available (by turning the rear control wheel - lower row on display) when the relevant function has been chosen (by turning the front control wheel - upper row on display)

### 1 Self timer

The self timer allows a delay in the activation of the shutter and a change in sequence of the mirror movement. Normally the mirror is raised before the shutter is tripped creating a pause between the two actions to minimize camera vibration. However, during this pause there will be no image in the viewfinder and no light metering available for any eventual exposure change. Therefore the Self timer function can be set to a sequence where the delay is followed by the mirror being raised instead. Normally the mirror will instantly return after an exposure but you can also choose a setting where the mirror remains raised. The Self Timer can though



Delay highlighted. 10 seconds chosen as option.

be set to provide virtually vibration-free shutter release. It can be used instead of a remote release cable/cord/device when split-second timing is not critical. The camera's exposure settings (Manual or Auto) will be according to the light metering requirements just prior to the mirror being raised so choose your method accordingly with long delays in very changeable lighting conditions.

### Self timer setting

The Self timer function is set via the control wheels in the following manner:

- 1) Press the **MENU** button on the grip
- 2) Turn the front control wheel until **Self Timer** appears
- 3) Press **ENTER** (**DRIVE** button on the grip)
- 4) Turn the front control wheel to access the options, that are:



**Delay**



**Mirror sequence**



**Mirror Up / Mirror Goes Down**

(A drop shadow will be displayed beneath the selected symbol, for example )

- 5) When **Delay** is highlighted -  - turn the rear control wheel to choose a delay range from 2 - 60s in 1s intervals.
- 6) Turn the front control wheel again to choose sequence.

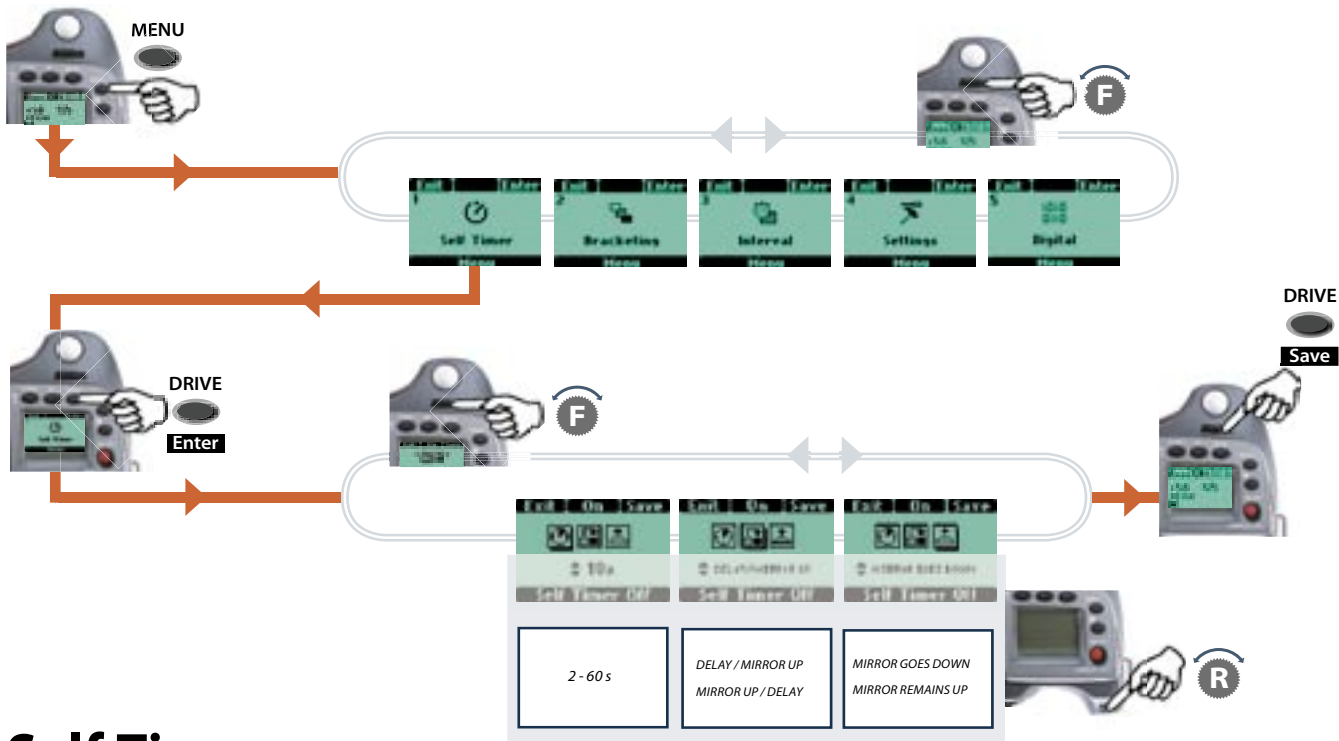

# Self Timer



Mirror sequence highlighted.  
'Delay first, then mirror raised'  
chosen as option.



Mirror down /up highlighted.  
'Mirror down after exposure'  
chosen as option.

- 7) When the **Delay / Mirror Up, Mirror Up/ Delay sequence** is highlighted -  - turn the rear control wheel to choose.

**Delay / Mirror Up** =

Delay for set amount of time then mirror raised then exposure made.

**Mirror Up/ Delay** =

Mirror raised then delay for set amount of time then exposure made.

- 8) Turn the front control wheel again for **Mirror goes down / Mirror remains up** -  - choice.

**Mirror goes down** =

Mirror returns to its normal position and the next film frame is advanced.

**Mirror remains up** =

Mirror remains folded up. No image is visible in the viewfinder until M UP button pressed.

- 9) Turn the rear control wheel to choose.  
10) Press **ON** (AF button) to activate or deactivate the self timer (toggle function)  
11) Press **SAVE** (the **DRIVE** button) to save the setting.  
12) Press the shutter release button to activate the sequence of events.

 Check the lower row on the screen for **ON** or **OFF** status

 You can halt the sequence by pressing the **ON / OFF (ESC)** button.



Number of exposures highlighted. 3 chosen as option.



Sequence highlighted. 'Standard, over, under' chosen as option.

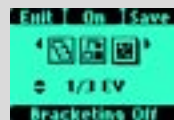

Step highlighted. 1/3 EV variation chosen as option.

## 2 Bracketing

The bracketing facility provides an automatic series of exposures; one at the standard exposure setting (Manual or Auto) and the others with pre-determined deviations in EV from the standard exposure. This is particularly useful when using transparency film with images containing a very wide tonal range, for example.

Firstly you make an assessment concerning the number of extra frames required, the order in which they should be taken, and by how much EV deviations there should be and the setting made accordingly. The first metered exposure (Manual or Auto) is the EV that determines the calculations for the bracketing sequence. In Manual mode you can choose between variations in aperture or shutter speed. Note the difference in operation between a **Single** and **Continuous** drive settings. In **Single** you must press the shutter release button separately for every separate exposure until the sequence is finished. In **Continuous** you can either maintain the pressure on the button to take all frames without stopping or you can release the pressure on the button and press again to continue to the end of the sequence without losing any frames within the set sequence.

- 1) Press the **MENU** button.
- 2) Turn the front control wheel until **Bracketing** appears
- 3) Press **Enter (DRIVE)** button on the grip
- 4) Turn the front control wheel to access the options, that are:



**Number of Exposures** (the number of exposures required in the sequence)



**Sequence** (the sequential order of the over- or under- exposures)



**Step** (the amount of EV variation form the standard exposure setting)



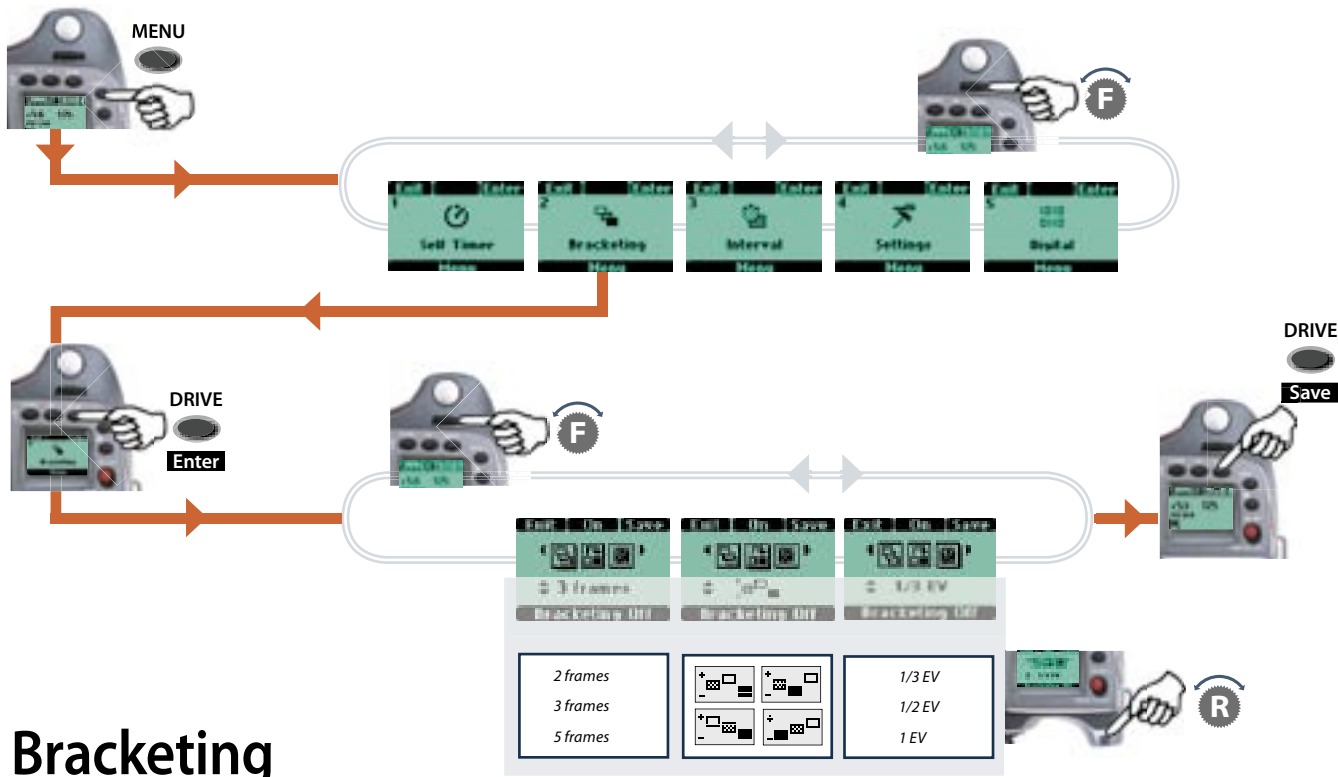

# Bracketing

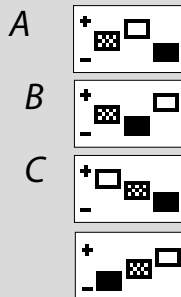



Screen after Bracketing setting activated indicating 3 frames remaining in a Standard, Over, Under, sequence with no adjustment to the



Viewfinder display indicating no adjustment to next frame and three frames left in the sequence.

(A drop shadow will be displayed beneath the selected symbol, for example )

5) In  turn the rear wheel to choose the number of frames required: 2, 3, or 5.

6) In  turn the rear wheel to choose one of four sequences:

A: **Standard, Over, Under**

B: **Standard, Under, Over**

C: **Over, Standard, Under**

D: **Under, Standard, Over**

7) In  turn the rear wheel to choose the amount of EV variation required: 1, 1/2, 1/3 EV.

8) Press **On** (AF button) to activate the setting.

9) Press **SAVE** (DRIVE button) to save the setting.



See note at the beginning of this section regarding the difference between Single and Continuous drive settings. In both cases, the bracketing function is automatically reset for a new sequence.



A bracketing sequence can be stopped mid-sequence by pressing the **ESC** (ON.OFF) button.



As an example, a 5 frame sequence with an EV 1 variation setting at 'Standard, Over, Under' would produce: Standard, +1EV, -1EV, +2EV, -2EV.

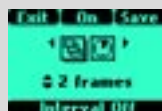

Number of exposures highlighted. 2 frames variation chosen as option.

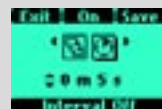

Interval duration highlighted. 5 seconds variation chosen as option.

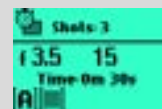

Screen after Interval setting activated indicating 3 shots remaining at 30 second intervals.

### 3 Interval

By using the interval setting, you can allow the camera to take a series of exposures automatically over a set period. This is often required for time and motion studies, security surveillance, nature study, etc. The exposure and focus settings (Manual or Auto) will be according to the camera settings at the time of exposure.

- 1) Press the **MENU** button on the grip
- 2) Turn the front control wheel until **Interval** appears
- 3) Press the **DRIVE (Enter)** button on the grip
- 4) Turn the front control wheel to access the options, that are:



**Number of exposures** (the number of exposures required)



**Interval duration** (the time interval between the exposures)

(The chosen symbol is indicated by a drop shadow)

- 5) In **Number of exposures**, turn the rear wheel to choose the number of exposures required: **2 – 32**
- 6) In **Interval duration**, turn the rear wheel to choose: **1 second – 24 hours**
- 7) Press **AF (On)** to activate the setting.
- 8) You can either press the shutter release button to activate the procedure immediately or press **SAVE** and then activate the stored sequence later.

The illustration here shows the grip LCD display when interval has been set three shots remaining in sequence of one frame every 30 seconds.



An interval setting can be stopped mid-sequence by pressing the **ESC** button.

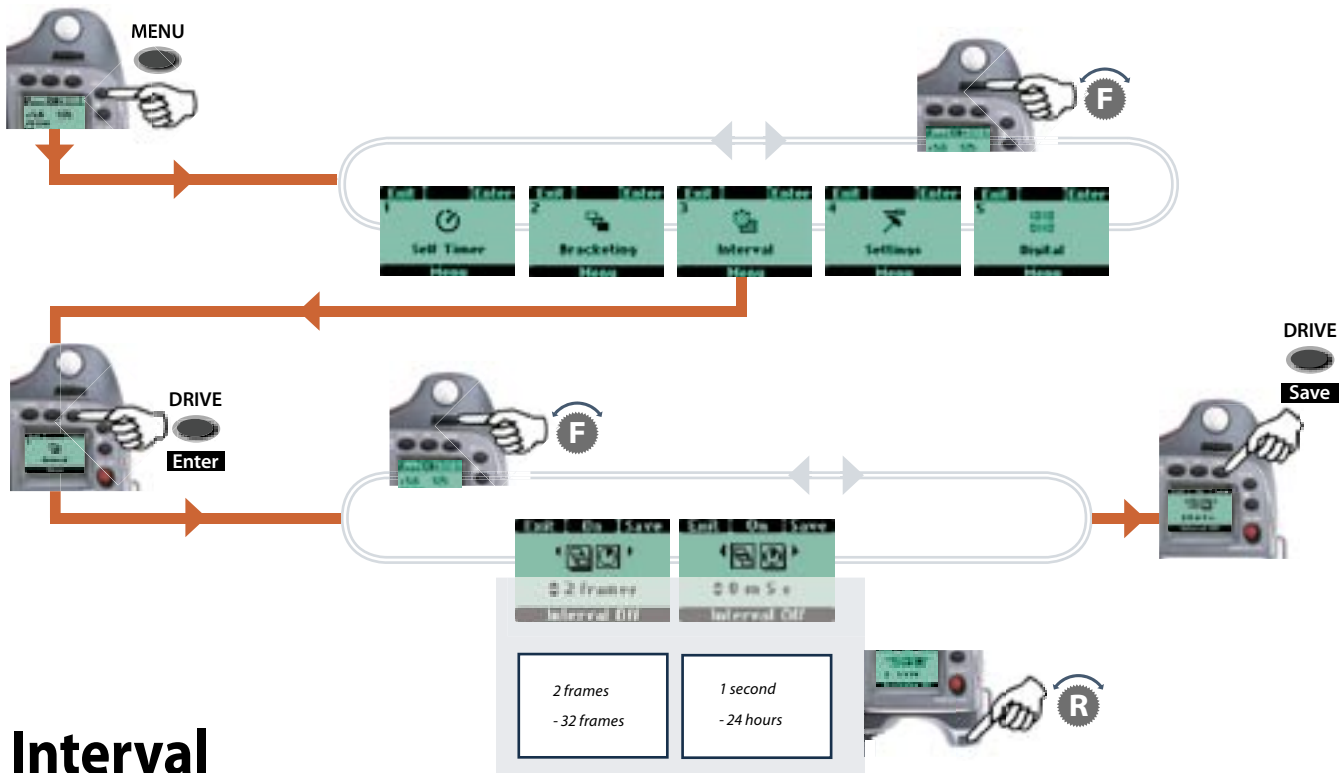

# Interval



## 4 SETTINGS

From the **Settings** screen you can access four main sub-settings: **Custom options**, **Imprint**, **Date & Time** and **Info** by turning the front control wheel. From each of these four sub-settings you can access further screens. **Custom options** has twenty-one more screens, **Imprint** has two more screens each with more choices, **Date & Time** has one more screen and **Info** has two more screens. Look at the main menu chart to get an idea of where all the options are on the menu tree

### 4.1 Custom options

- 1) Press the **MENU** button on the grip.
- 2) Turn the front control wheel until **Settings** appears.
- 3) Press the **DRIVE (Enter)** button on the grip.
- 4) Turn the front control wheel to access **4.1 Custom options** and press the **DRIVE (Enter)** button.
- 5) You can now access the 21 choices available. The main heading is the chosen function (accessed by the front control wheel) followed by the settings available (accessed by the rear control wheel) beneath.

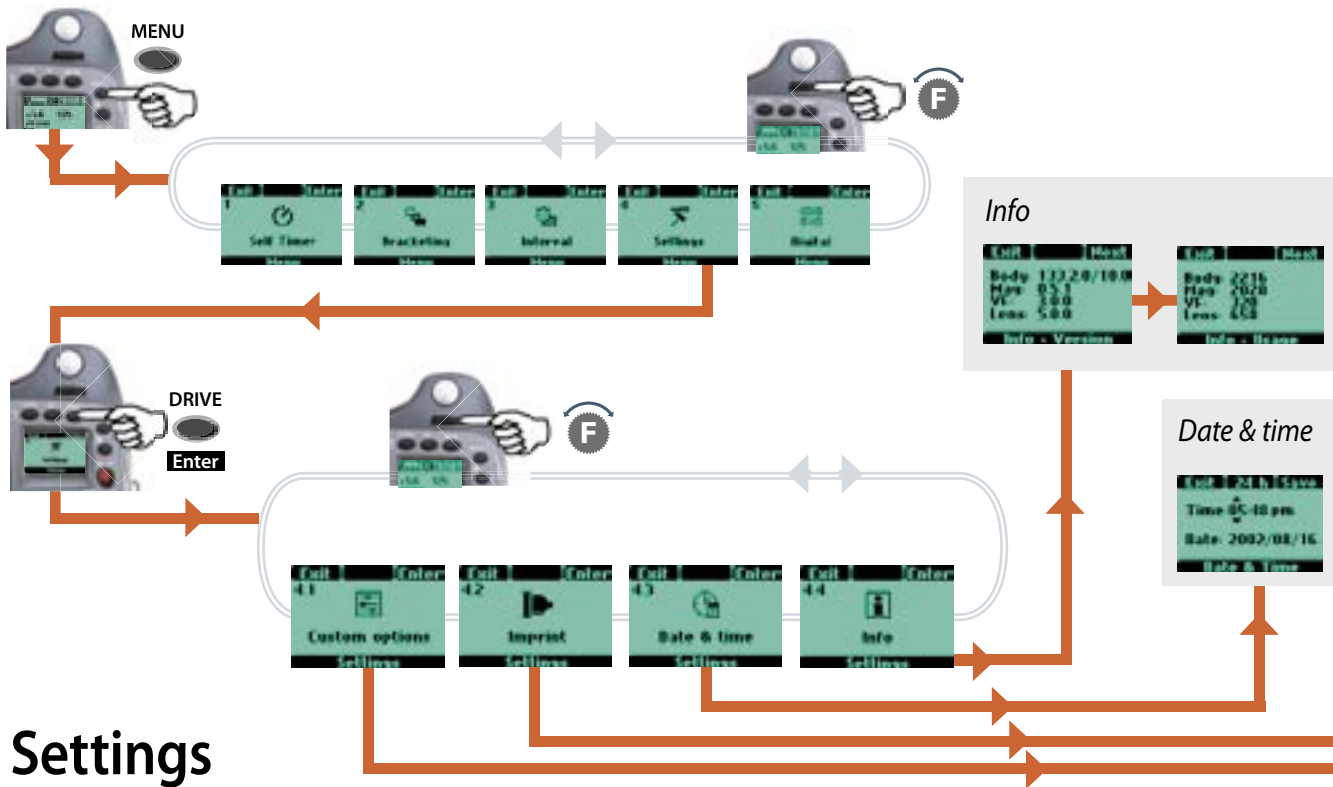

# Settings

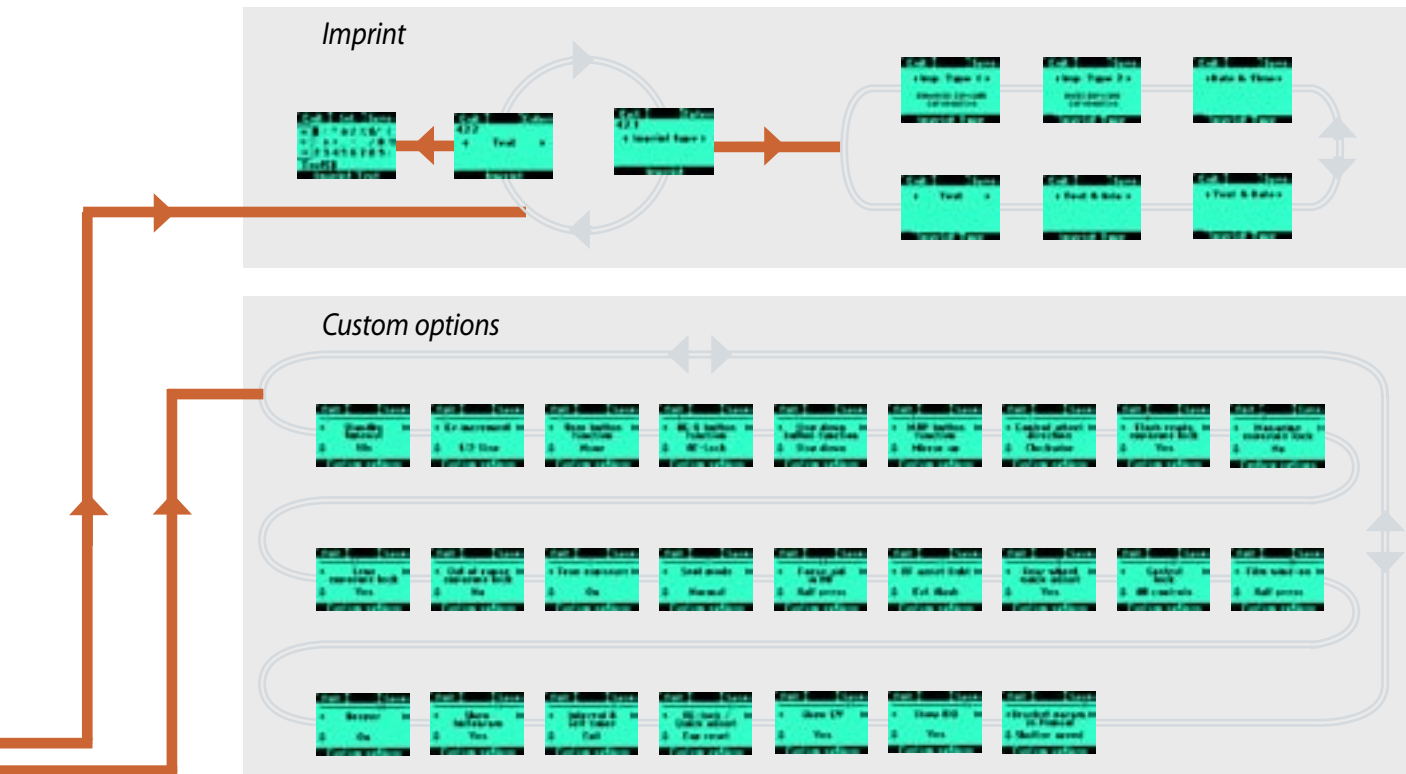



### Standby timeout 1

- 5s • 10s • 15s • 30s

Determines the amount of time the camera remains active before it automatically reverts to standby mode (indicated on the grip LCD by the HD logo).

Minimises battery consumption.



### EV increment 2

- 1 Step • 1/2 Step • 1/3 Step

Determines the amount of EV change applied (per click of either the front or rear control wheels) to either aperture or shutter speed.



### User button function 3

- None • Standby (enters standby) • Stop Down • Flash Measure • Interval timer • Multi Exposure • Self Timer • Bracketing • AF drive (lens in MF or AF) • Mirror up • B mode • T mode • Histogram (shows last histogram) • Grey balance exposure • Cycle LM mode • Delete last image • Dig. foc. check



Sets which function will be immediately activated when the User button is pressed (you cannot alter the setting in this mode though, only use it). The button has a toggle function so that by pressing it again the new setting will be de-activated.

 *The User, AE-L, Stop Down and Mirror Up buttons are very valuable time and effort saving functions that you should try to incorporate in your working methods. See special description at the end of this section for full details.*

### AE-L button function 4

- None • Standby (enters standby) • Stop Down • Flash Measure • Interval timer • Multi Exposure • Self Timer • Bracketing • AF drive (lens in MF or AF) • Mirror up • B mode • T mode • Histogram (shows last histogram) • Grey balance exposure • Cycle LM mode • Delete last image • Dig. foc. check • AE-lock

Sets which function will be immediately activated when the AE-L button is pressed (you cannot alter the setting in this mode though, only use it). The button has a toggle function so that by pressing it



again the new setting will be de-activated.

 See User button note

### Stop down button function 5

• *None* • *Standby (enters standby)* • *Stop Down* • *Flash Measure* • *Interval timer* • *Multi Exposure* • *Self Timer* • *Bracketing* • *AF drive (lens in MF or AF)* • *Mirror up* • *B mode* • *T mode* • *Histogram (shows last histogram)* • *Grey balance exposure* • *Cycle LM mode* • *Delete last image* • *Dig. foc. check*

Sets which function will be immediately activated when the Stop down button is pressed (you cannot alter the setting in this mode though, only use it). The button has a toggle function so that by pressing it again the new setting will be de-activated.

 See User button note

### Mirror up button function 6

• *None* • *Standby (enters standby)* • *Stop Down* • *Flash Measure* • *Interval timer* • *Multi Exposure* • *Self Timer* • *Bracketing* • *AF drive*



(*lens in MF or AF*) • *Mirror up* • *B mode* • *T mode* • *Histogram (shows last histogram)* • *Grey balance exposure* • *Cycle LM mode* • *Delete last image* • *Dig. foc. check*

Sets which function will be immediately activated when the Stop down button is pressed (you cannot alter the setting in this mode though, only use it). The button has a toggle function so that by pressing it again the new setting will be de-activated.

 See User button note

### Control wheel direction 7

• *Clockwise* • *Counter clockwise*

Determines the effect the direction of the controls wheels have on a setting.

For example, by moving the front control wheel to the left you can alter the aperture setting from f/8 to f/6.8 to f/5.6 and so on. By changing the wheel direction setting however, the same action of turning the wheel to the left would then produce the opposite effect, that is, the aperture settings would change from f/8 to f/9.5 to f/11, and so on.





### Flash ready exposure lock 8

- **Yes • No.** Allows you to make an exposure before the flash is fully charged. For use with integral flash unit or other TTL compatible flash units connected to the hot-shoe. Not valid for flash units connected by the PC connector.

**Yes** blocks the shutter until flash is ready.

**No** allows shutter release before flash is ready.



### Magazine exposure lock 9

- **Yes • No** Allows you to release the camera with an attached sensor unit without power or an attached magazine with no film.

**Yes** blocks the shutter with an attached sensor unit without power or an attached magazine with no film and also produces a warning message on the grip and viewfinder LCD.

**No** allows the shutter to be released.

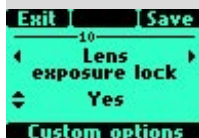

### Lens exposure lock 10

- **Yes • No**

Allows you to release the camera without a lens attached.

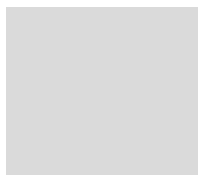

**Yes** blocks the shutter if there is no lens attached and also displays a message on the grip LCD: **No lens.**

**No** allows the camera to perform a release operation without a lens.



### Out of range exposure lock 11

- **Yes • No**

Allows you to release the camera when either the aperture or shutter speed setting is beyond the working range (indicated on the LCDs by "--").

**Yes** blocks the shutter if beyond the working range.

**No** allows the shutter to be released if beyond the working range.



### True exposure 12

- **On • Off**

Determines whether the exposure is automatically adjusted to create a true exposure setting. (See Appendix, Glossary of Terms for full explanation).

**On** allows the adjustment.

**Off** retains the normal setting.



## Spot mode 13

### • Normal • Zone

Determines how the camera behaves when set to Spot Mode.

**Normal** makes the camera behave in the same fashion as when set to Average or Centre Weighted.

**Zone** makes the camera behave in the same fashion as the Hasselblad 205FCC. That is, the central spot is placed over a particular area of the subject and the AE-L button is pressed. The exposure is then calculated assuming that the metered area is 18% grey or Zone 5 and is indicated on the LCD as Zone 5 (see Appendix / Glossary of Terms). Alternatively, the area can be re-classified to another zone by turning the rear control wheel.

Then, when the camera is moved, the areas within the central spot are indicated by their zone values.



## Focus aid in MF 14

### • Half press • Always • Off

Sets how the focus aid arrowhead LED symbols



appear in the viewfinder display in manual focus mode.

**Half press** makes them visible when the shutter release button is pressed half way.

**Always** makes them visible all of the time when camera is active.

**Off** disables them completely.

## AF assist light 15

### • Camera • Ext flash • Off

Allows projection of light pattern to assist the autofocus system in poor light or low contrast situations.

**Camera** sets the integral AF assist illumination to be always active.

**External flash** activates the AF assist illumination projected by a suitable attached external flash unit. When detached, however, the integral system is automatically used.

**Off** sets the AF assist to remain always inactive.



### Rear wheel quick adjust 16

- *Yes • No*

Allows rear control wheel to make a rapid EV adjustment (or EV compensation) in auto-exposure mode.

*Yes* turns the setting on. By turning the rear control wheel, the adjustment is made and appears on both LCDs as a  $\pm$  symbol between the shutter speed and aperture values. The amount of deviation also appears above the scale to the left of the aperture value on the viewfinder LCD.

*No* turns the function off completely.



### Control lock 17

- *All controls • Wheels • Off*

Sets the amount of locking used when the Control Lock button is pressed.

*All controls* locks control wheels and buttons.

*Wheels* locks only control wheels. They remain operable in any setting mode, however.

*Off* disables lock function.



### Film wind-on 18

- *Direct • Half press*

Sets when the film will be advanced to the first frame.

*Direct* advances film automatically to the first frame when the film holder is inserted or when the magazine is attached.

*Half press* advances the film only when the shutter release is pressed to half press position.



### Beeper 19

- *On • Off*

Sets the audible beeper signal.

*On* enables the signal.

*Off* disables the signal.

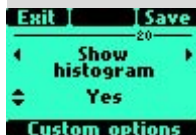

### Show histogram 20

- *Yes • No*

Sets whether a histogram of a digital exposure appears on the LCD after exposure. Only for use together with digital backs that support this feature.



*Yes* enables the setting.

*No* disables the setting.

## Interval & Self Timer 21

### • *Exit* • *Stay*

Allows either the Interval or Self Timer mode to remain active after an exposure or immediately return to standard setting.

*Exit* clears the setting and produces an automatic return to standard setting after an exposure.

*Stay* retains the setting after an exposure.

## AE-Lock & Quick adjust 22

### • *Exp Reset* • *Saved*

Allows either the AE-Lock or Quick adjust mode to remain active after an exposure or immediately return to standard setting.

*Exp Reset* clears the settings and produces an automatic return to standard setting after an exposure.

*Saved* retains the AE-Lock or Quick adjust settings after an exposure.

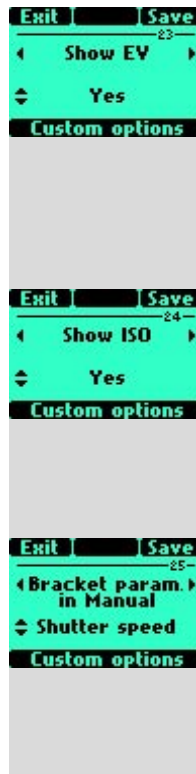

## Show EV 23

### • *Yes* • *No*

Allows the display of EV settings on the grip LCD

*Yes* enables the display.

*No* disables the display.

## Show ISO 24

### • *Yes* • *No*

Allows the display of ISO settings on the grip LCD

*Yes* enables the display.

*No* disables the display.

## Bracket parameter in manual 25

### • *Shutter speed* • *Aperture*

Allows either the shutter speed setting or the aperture setting to change when using the Bracketing mode



## 5 DIGITAL

ISO and White Balance settings for digital capture are changed as follows:

- 1) Press the **MENU** button on the grip.
- 2) Turn the front control wheel until the **Digital** (screen 5) appears.
- 3) Press **ENTER** (**DRIVE** button on the grip).
- 4) Turn the front control wheel to access the options, that are:

### ISO setting and White balance

- 5) In **ISO Setting** turn the rear control wheel to choose an ISO value of:  
**50, 100, 200 or 400.**

In **White balance** turn the rear control wheel to choose between:  
**manual, flash, daylight or tungsten.**

- 6) Press **SAVE** (the **DRIVE** button) or half press the shutter release button to save the setting.

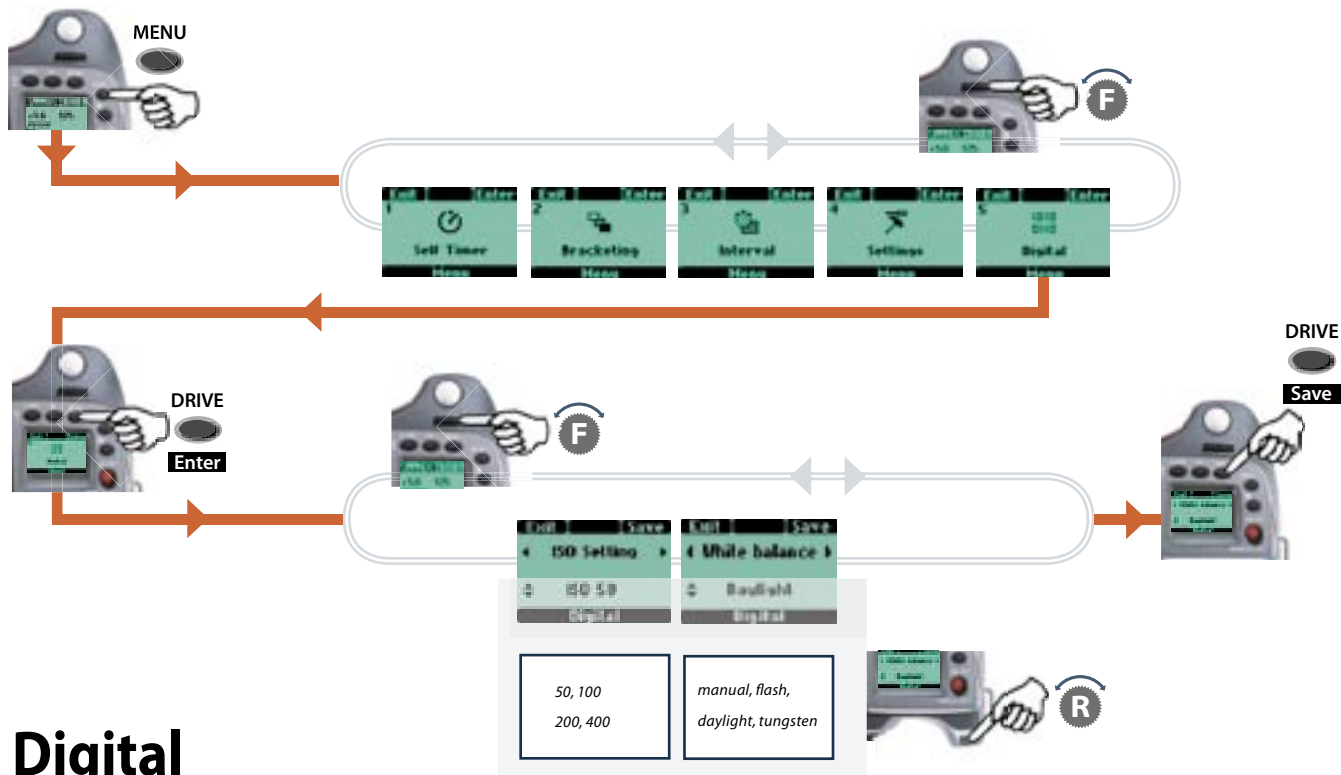

# Digital

## Button function choice

The User button, AE-L button, StopDown button and Mirror Up button can be custom programmed to directly access a list of functions.

A quick way to do this is to use the following short-cut method:

- 1) Click the MENU button.
- 2) Then immediately click the button you want to change.

This directly accesses the "Custom options" level in the menu for that particular button.

(This is also a quick way to access the "Custom options" level for other items than User button function).

Press the chosen button to quickly access and activate the programmed function and press it again to de-activate the function and return to the standard screen.

### None

---

The user button has no function.

### Standby

---

Sets the camera in standby mode to save battery consumption.

### Stop down

---

Stops the lens down.

### Flash Measure

---

Initiates flash measure function.

### Interval timer

---

Initiates interval timer function.

### Multi exposure

---

Initiates multi exposure function.

### Self timer

---

Initiates self timer function.

### Bracketing

---

Initiates bracketing function.

### AF Drive

---

Activates the AF system in any focusing mode. When the button is pressed the AF system sets the correct focusing point automatically. This is a rapid, accurate and handy way of using the AF system when the



camera is set to *Manual focus mode*. In this manner you take advantage of the accuracy and certainty of the autofocus system while retaining the control inherent in manual focusing mode.

---

### **Mirror up**

Controls the mirror up or down function (same function as the M-UP button).

---

### **B mode**

Sets the camera to *B exposure mode*.

---

### **T mode**

Sets the camera to *T exposure mode*.

---

### **Histogram**

Recalls the last shown histogram.

---

### **Grey balance exp.**

Initiates a grey balance exposure.

---

### **Cycle LM mode**

Changes the light-metering method in a loop manner: Centre Weighted/Average/Spot.

---

### **Delete last image**

Activate the delete function for the last image in a digital back.

---

### **Dig. foc check**

Displays last exposure taken at 100% scale on digital backs with LCD.

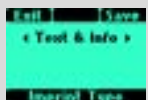
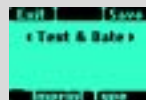
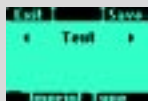
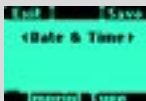
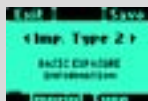
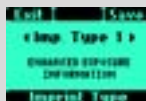
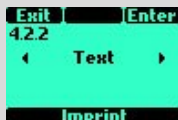
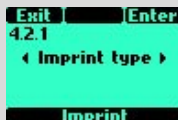

## 4.2 Imprint

The Imprint facility controls the text that will appear along the edge of each frame. It is possible to imprint approximately 40 characters at one time.

From **4.2 Imprint**, press **Enter** to access:

- **4.2.1 Imprint Type**
- **4.2.2 Text**

### 4.2.1 Imprint Type

In Imprint Type you can decide which technical information shall be recorded.

From **4.2.1 Imprint Type** press **Enter**. By moving the front control wheel you can access six options:

- **Imp. Type 1** *prints the relevant information: aperture, shutter, metering mode, exposure mode, exposure compensation and flash compensation.*
- **Imp. Type 2** *prints the relevant basic information only: aperture, shutter, and exposure correction.*
- **Date & Time** *date & time only (the correct date and time is set through the Settings menu under 'Date & Time'.)*
- **Text & Date** *prints text plus date*
- **Text & Info** *prints text plus basic info*
- **Text** *prints text only (that you have created in 4.2.2 Text)*

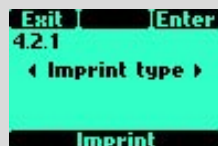

#### 4.2.2 Text

In Text you can compose your own combination of letters, words, symbols, etc for film edge information. The same procedure is also used to change a Profile name.

##### Film edge text composition:

From 4.2.2 Text press **ENTER**.

##### Profile name change :

From the standard screen, click on the **PROFILES** button, scroll to and highlight the name in the profile list, and press **Load**. You will now be returned to the standard screen where you press the **PROFILES** button again. You will then be returned to the profiles screen again, where you press **Save** to finally access the 'Profile name' screen.

- On the left side of the screen there is a small box frame containing an **X** symbol and two arrow symbols. By turning the front control wheel, the cursor will enter the box and by turning the rear control wheel the cursor will move up and down. These symbols describe what will happen to the cursor on the row of text being changed when the **Sel.(AF)** button is pressed. For example, if the **X** in the box is marked and you press the **Sel.(AF)** button, the highlighted character in the text row will be deleted. If, however, you have the left pointing arrow in the box highlighted and press the **Sel.(AF)** button the cursor in the row of text will move to the left to highlight another character which you can then change or erase.
- By turning the front control wheel, the cursor moves horizontally.
- By turning the rear control wheel, the cursor moves vertically and introduces all available characters.

To store the characters, proceed as follows:

## Removing text

```
Exit Sel. Save
X ! " # $ % & ' (
+ ) * + , - . / 0 1
→ 2 3 4 5 6 7 8 9 :
Text|
Imprint Text
```

1) Turn the front and rear control wheels until the X symbol is highlighted.

On the text row, the text cursor is automatically placed to the right of the character that is to be changed.

```
Exit Sel. Save
X ! " # $ % & ' (
+ ) * + , - . / 0 1
→ 2 3 4 5 6 7 8 9 :
Text|
Imprint Text
```

2) Press Sel. (AF button) and the character will be erased.

```
Exit Sel. Save
X ! " # $ % & ' (
+ ) * + , - . / 0 1
→ 2 3 4 5 6 7 8 9 :
Te|
Imprint Text
```

3) Repeated pressing of Sel. will progressively erase all the characters in the line.

## Adding text / Changing profile name

```
Exit Sel. Save
X q r s t u v w x y
+ z { | } ~ ¡ ¢ £ ¤
→ ¥ ¦ § ¨ © ª « ¬
@ Jen|
Imprint Text
```

1) After erasing unwanted text, turn the front and rear control wheels until the desired character is highlighted (in this case the copyright symbol) and press Sel.

```
Exit Sel. Save
X | ! " # $ % & ' (
+ ) * + , - . / 0 1
→ 2 3 4 5 6 7 8 9 :
@ |
Imprint Text
```

2) Choose the next character in the same manner (in this case a space) and press Sel.

```
Exit Sel. Save
X : < = > ? @ A B C
+ D E F G H I J K L
→ M N O P Q R S T U
@ J|
Imprint Text
```

3) The capital letter 'J' has been highlighted and saved in this example.

```
Exit Sel. Save
X V W X Y Z [ \ ] ^
+ _ ` a b c d e f g
→ h i j k l m n o p
@ Je|
Imprint Text
```

4) Repeat the procedure until all the letters and characters you want appear. As you progress with more

```
Exit Sel. Save
X V W X Y Z [ \ ] ^
+ _ ` a b c d e f g
→ h i j k l m n o p
@ Jen|
Imprint Text
```

characters, those to the left will disappear from the screen so that you can see what you are adding. Don't forget there is a maximum of 37 characters.

```
Exit Sel. Save
X q r s t u v w x y
+ z { | } ~ ¡ ¢ £ ¤
→ ¥ ¦ § ¨ © ª « ¬
@ Jens|
Imprint Text
```

If you make a mistake you must remove each character singly (see Removing text) until you reach where you want to make a change and then return to the 'Adding text' procedure again.

```
Exit Sel. Save
X ! " # $ % & ' (
+ ) * + , - . / 0 1
→ 2 3 4 5 6 7 8 9 :
@ Jens|
Imprint Text
```

5) This example shows a completed 15 character text line with symbols, spaces, large and small letters.

```
Exit Sel. Save
X V W X Y Z [ \ ] ^
+ _ ` a b c d e f g
→ h i j k l m n o p
@ Jens Karlsson|
Imprint Text
```



- 1) You can firstly clear an unwanted line of text by highlighting the **X** symbol in the box and repeatedly pressing the **Sel.(AF)** button.
- 2) Find the character you want by turning the rear control wheel until it appears on the screen. (The 'space' character is the 'empty space' to the left of the exclamation mark, top row furthest to the left).
- 3) Move the cursor with a combination of the front and rear control wheels until the desired character is highlighted.
- 4) Press the **Sel.(AF)** button to save the character that will then appear along the lower part of the screen.
- 5) Continue with the same procedure until you have completed the line of characters and symbols.
- 6) Press the **Save (DRIVE)** button to store the new setting.  
You can erase or change a character at any time in this mode but remember to save any changes made.

#### 4.3 Date & Time

##### Date & Time

- 1) From **4 Settings**, press the **Enter (DRIVE)** button.
- 2) Turn the front control wheel until **4.3 Date & Time** appears.
- 3) Press the **DRIVE (Enter)** button.

You will now see the following on the display.

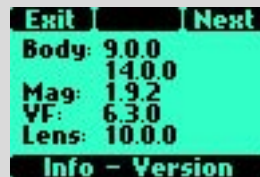

- 5) By turning the front control wheel you can move the cursor to mark the following for change: hours, minutes, year, month and day respectively. By pressing the 24 h button (AF), you can choose between a 24 hour or 12 hour system for time.
- 6) Turn the rear control wheel to make the changes when the cursor is correctly positioned.
- 7) Press the **Save (DRIVE)** button to store the new setting.

#### 4.4 Info

Used to check component usage for servicing reasons.

- 1) From **4 Settings**, press the **Enter (DRIVE)** button.
- 2) Turn the front control wheel until **4.4 Info** appears.
- 3) Press the **Enter (DRIVE)** button.

The display now shows a list of camera components and to the right of each individual component a figure that represents the number of actions taken by that component. Please note that even a completely new camera will have registered actions as these occur during testing before delivery.

Press the **Next (DRIVE)** button to display the software version for each component.



# 10

## Flash

- Sync at all shutter speeds to 1/800s
- Integral fill-flash
- SCA 3002 compatible
- Flash measure capability
- Rear sync capability

# H1D

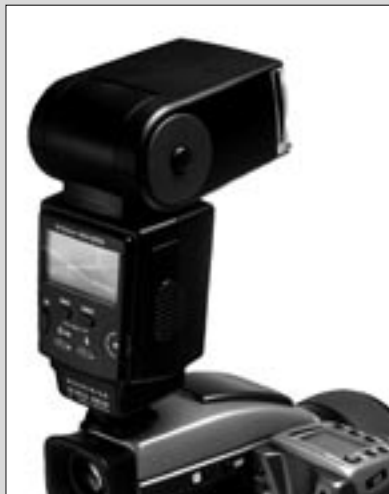

*The H1D can be used together with most flash units. Connection is either by the PC socket or by the hot shoe if the unit is compatible (see note below).*

*The viewfinder houses an integral fill-flash with a guide number of 12 and features OTF/TTL flash control. This unit is capable of providing enough illumination for simple indoor shots at shorter distances as well as many fill flash functions outdoors. Flash output can be adjusted separately from ambient exposure for optimum control. Separate flash units can be used in dedicated mode when connected to the hot shoe if the unit is compatible with the SCA3002 (Metz) system using a Hasselblad SCA3902 adapter. This provides a cable free link up for information transfer.*

*Automatic flash works equally well with digital capture as well as film backs.*

*Flash synchronisation can be set to normal or rear (the beginning or end of an exposure).*

*Please see the relevant user manuals for information regarding separate flash units.*



*As with all strobe/studio flash use, very particular attention should be taken to ensure correct connections and general handling practice. Potential dangers might increase when cameras are also connected to electronic peripherals (computers, lighting units, etc) and should diminish when IR and similar wireless flash release devices are used. Victor Hasselblad AB can accept no responsibility whatsoever for accidents that might occur when Hasselblad equipment is used in combination with third-party units of any description.*

### **General**

When an automatic TTL flash unit is attached, the H1D automatically takes into account whether the sensor unit is in place or whether a film magazine has been fitted, as the camera



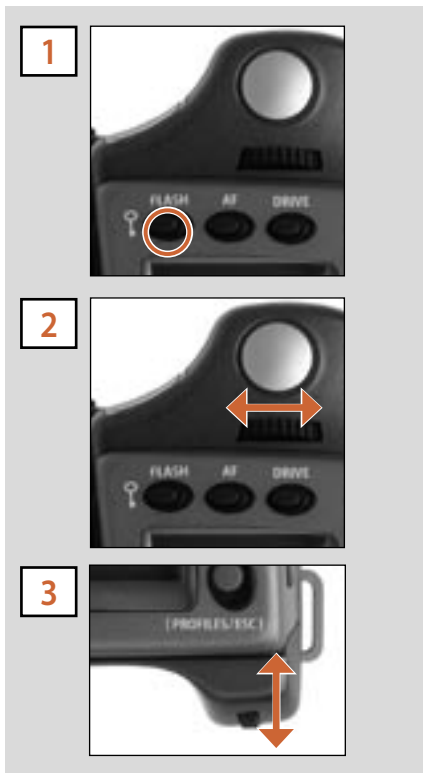

must make the appropriate changes necessary for digital and film capture. This change is signified by a D symbol appearing in the top left FLASH section of the grip LCD.

When using the **A** or **S** setting together with flash, the exposure requirements of the camera will dominate which might produce slow shutter speeds indoors, for example, requiring the use of a tripod. If, on the other hand, you select **P** or **Pv** instead, then a shutter speed of 1/60 is automatically chosen by the camera enabling you to hand hold.

When using flash close up or when using larger aperture settings, remember that the flash unit's output has a specific minimum duration which might still be too great for correct exposure. Read the unit's output specifications for further information regarding any potential restrictions.

You can use the flash metering capability with external flash units of all kinds (TTL flashes must be set to Manual mode). The metering also works with digital backs.

Rear sync is a useful feature used either for effect or to produce a more 'natural' look when combining long exposures involving light trails and flash.

When using suitable dedicated units (compatible with SCA3002), adjustments are made automatically and governed by the settings on the camera. This applies to whether the flash unit is set to TTL or whether it is set to its own integral metering system (A). However, when using a digital back, the A mode on the flash unit is recommended.

Control of either the integral flash unit or separate SCA3002 compatible flash unit regarding the two functions, exposure compensation and shutter sync, is via the grip. The flash measure function can be used for flash units that are not SCA 3002 compatible or for SCA 3002 compatible units at manual setting.

*Only flash units specially adapted for use with the H1D / H1 should be connected to the hot shoe on the camera.*

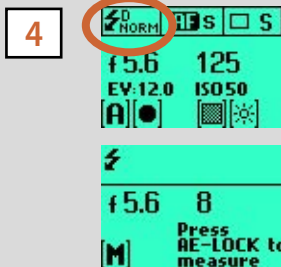

**-1.0 Ev Flash Rear**

Example of viewfinder LCD display showing Flash set to Rear sync as well as -1EV exposure compensation.



To change the balance between flash output and camera exposure requirements to produce a variety of effects, use the exposure compensation function. For various long exposure effects use the sync function. To make flash exposure tests use the flash measure function.

**To access the controls:**

- 1) Activate the camera and press the FLASH button once.
- 2) Turn the **front** control wheel to set the amount of compensation required:
  - from +3EV through -3EV (amount dependent on ISO value)
- )
- 3) Turn the **rear** control wheel to set:
  - normal sync (flash triggered just after the shutter opens)
  - rear sync (flash triggered just before the shutter closes)
  - flash measure (with non-TTL flash units or TTL units in Manual mode)
- 4) The grip LCD shows the flash mode - Normal or Rear - in the standard display. However, when set to Flash Measure, a specific screen requests you to press the AE-L button in order to make a reading.

### Integral flash

The integral flash unit features the following specifications:

Guide no.	12
Coverage	56° horizontal, 44° vertical
Maximum light fall-off at side centres	- 1EV (50%)
Colour temperature (full flash)	5,000 – 5,600° K



Green LED flash symbol to left of viewfinder LCD display.

**Low flash**



To raise the flash unit into its operative position, slide the flash-unit catch backwards in the direction of the flash symbol. To return the flash unit into its closed position, push down on the top of the unit until it clicks back into place. The flash unit is automatically activated when it is in the operative position and de-activated when returned to its stored position.

The green LED flash symbol blinks in the viewfinder when the flash unit is charging and remains stationary when fully charged. The flash output can also be adjusted for optimum light balance in fill-flash situations.

 Do not use the integral flash together when another external TTL flash unit is connected (and used in TTL or A mode)

 For full coverage with the integral flash, use 80 mm or longer lenses.

**Using the integral flash:**

- 1) Slide the flash-unit catch backwards in the direction of the flash symbol.
- 2) Set any required flash compensation (FLASH button / front control wheel / Save).
- 3) Make an exposure.
- 4) If the settings were incorrect to match the output of the flash unit, a red triangle appears in the viewfinder along with a flashing green 'flash' symbol together with a warning message on the LCD - 'Low flash'. The grip LCD will also display a warning message - 'Low flash measurement'.
- 5) Conventional measures should then be taken to correct the situation. (That is: move closer to the main subject, use a larger aperture setting or use a faster film).

### **Separate flash unit connection and use**

Separate flash units can be electrically connected either by way of the hot shoe accessory

holder (if SCA3902 compatible) on the top of the viewfinder or via a cord to the PC connection port on the left hand side of the camera body. Slave unit switches/ transmitters can also be connected similarly dependant on unit (see specific user manuals for details).

Keep the plastic safety cover in place in the hot shoe when not in use.

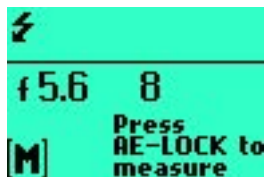

### Flash measure

You can measure the effect of an attached flash unit (with PC connected flash units and SCA3902 compatible flash units set to M mode), where the camera acts much as a flash meter would. By choosing 'Flash measure', a trial exposure is made with the auxiliary shutter still in place which therefore prevents film frames from being used. The aperture setting can be adjusted and more trial exposures made until the information on the grip LCD is satisfactory.

#### To use flash measure:

- 1) Press the **FLASH** button on the grip once to access the flash option screen.

- 2) Turn the rear control wheel until **Flash measure** appears.
- 3) Press the **DRIVE/Save** button to access the flash exposure screen.
- 4) Make preliminary required aperture setting.
- 5) Press the **AE-L** button. The camera will close the aperture, raise the mirror and fire the flash. Light reflected from the flash lit subject will be reflected off a white spot on the auxiliary shutter to the meter sensor.
- 6) Deviations from a normal exposure are displayed as differences in EV on the grip LCD and the viewfinder LCD. If 'high' or 'low' appears, change the aperture accordingly and make a new test reading.
- 7) Change the aperture until Diff EV: 0 appears, or the desired amount of deviation from the normal exposure.  
Lo signifies more than 2 EV under  
Hi signifies more than 2 EV over

## 11

## Optional Accessories

- Film magazine
- Instant film back
- Converter
- Extension tubes
- Rechargeable battery grip
- IR Release unit
- Release cord
- Filters
- Tripod quick coupling
- Support strap
- Grid focusing screen
- Flash adapter
- Proshade
- CF lens adapter

# H1D



*There are a number of optional accessories available for the H1D with more being developed to suit a variety of photographic situations and needs. Please see [www.hasselblad.com](http://www.hasselblad.com) for the latest information. The figures in brackets after the headings are the product codes.*

---

***HM 16-32*** **(3033016)**

Detachable film magazine HM 16-32 for 120/220 film. See separate section in this manual for full description.

---

***Magazine film holder HM 16-32*** **(3053320)**

Separate magazine insert for the film magazine HM 16-32.

---

***HMi 100*** **(3033100)**

The HMi 100 is an instant film magazine for type 100 instant film. Extremely useful for quickly checking exposure, lighting, and composition. The magazine is mounted and dismounted as easily as the standard magazines.

---

***Converter H 1.7X*** **(3023717)**

The Converter attaches between the lens and the body to increase the focal length by a factor of 1.7. This provides a convenient way to expand your range of lenses. The Converter H 1.7 X features the same outstanding optical and mechanical quality as all the lenses in the Hasselblad H1D system. The optical design consists of 6 elements in 4 groups.



### ***H 13, 26 and 52 Extension tubes*** ***(3053513, 3053526 and 3053542)***

The Extension tubes attach between the lens and the body to reduce the close focusing distance for close up photography. They are available in three sizes: 13mm, 26mm and 52 mm. As the H1D has a TTL light metering system, exposure compensation is automatic.



### ***Battery Grip Rechargeable 7.2V*** ***(3043348 and 3053568)***

Removable H1D grip containing Li-Ion rechargeable battery with a capacity up to 1850 mAh. An economical option for full time users. A Battery Charger (3053568) is included.



### ***Release cord H*** ***(3043370)***

Remote release cord with a cable length of 0.5 m.



### ***UV-sky filters*** ***(3053470, 3053474 and 3053478)***

Absorbs UV radiation and reduces blue haze without affecting colours. Also protects the front lens surface. Particularly recommended when the camera is used in harsh conditions. There three sizes available to suit various lenses: UV-sky 67 mm (3053470), UV-sky 77 mm (3053474) and UV-sky 95 mm (3053478).

### ***Tripod quick coupling*** ***(3043326)***

Mounted on a tripod, this accessory facilitates rapid attachment and removal of the camera. The camera is firmly held in an exact and repeatable position. Two integrated spirit levels make horizontal positioning of the camera easy. The Tripod quick-coupling fits 1/4" and 3/8" tripod threads and has a safety catch. Allows the HMi100 instant back to be used on large plate tripod heads.



### **Support strap H1**

**(3053623)**

Improves comfort and security in hand-held photography.

### **Focusing screen HS standard**

**(3043305, 3043324)**

Spherical Acute-Matte D type. Central markings for spot ( $\varnothing$  7.5 mm) and AF metering area (supplied with H1D). (3043324 with 36 x 48 mask)

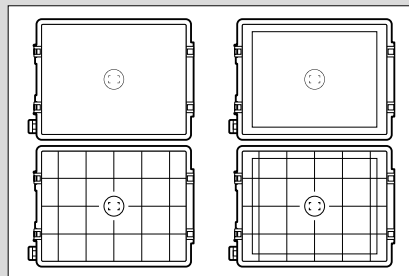

### **Focusing screen HS-grid**

**(3043310, 3043310)**

Spherical Acute-Matte D type with grid and central markings for spot ( $\varnothing$  7.5 mm) and AF metering area. Grid provides aid in technical, architectural, and other detail photography. (3043310 with 36 x 48 mask)

### **Flash adapter SCA**

**(3053393)**

Adapter fro Metz range of external flashes. Provides full TTL/OTF dedication.

### **Battery Grip CR-123A**

**(3043340)**

Removable H1 grip with compartment for three CR-123 lithium batteries(supplied with H1D).

### **Proshade V/H 60-90**

**(3040740)**

Professional bellows type lens shade adjustable for use with all HC lenses. Provides highly efficient protection against stray light . Its compact, flat folding design saves space in the equipment case. Also functions as filter holder fro glass, gelatin or plastic filters. Three different adapters available to suit all HC lenses. Other adapters available to fit Hasselblad V-system lenses.







### ***H system CF lens adapter***

***(3043500)***

Adapter to allow the use of all C-type lenses from the Hasselblad V-system. The automatic focusing system in the H1 camera can be used to guide the manual setting of focus. Light is measured at full aperture with all lenses which produces aperture and shutter speed information display in the camera for manual setting. With CFE lenses, however, a preset aperture is automatically transferred to the camera. Shutter cocking is manual with all lenses and is swiftly carried out by an easily accessible lever.



**12**

## Appendix

- Glossary of Terms
- P and Pv explanatory charts
- Technical specifications
- Equipment Care, Service & Guarantee

# H1D

## Glossary of Terms

*For the sake of clarity, here are short and simple explanations of several terms, items and features mentioned in the manual that may be unfamiliar to some.*

### Bar code

Some roll film brands have a Bar code which the H1D magazine can recognize and interpret. This automatically transfers the ISO rating and film length of the film to the camera and saves you from an incorrect setting. However, you might wish to rate the film at a different ISO setting, in which case you should transfer to manual ISO setting.

### Bracketing

The practice of making extra exposures over or under (normally both) the 'standard' exposure to ensure the desired result. This is particularly useful when using transparency film in difficult lighting conditions. Easily set and controlled with the H1D.

### Browse/Scroll

A computer term referring to the method of searching through stored digital information, normally accessing the information visually, controlled by buttons or control wheels (real or digital).

### Custom setting

The setting chosen by the user that differs from the default setting.

### EV

Exposure Value. It represents the standard photographic notation within exposure control. For example, if you change the aperture on a lens from  $f/11$  to  $f/8$ , you will increase the exposure by 1EV. Similarly, if you change the shutter speed from  $1/15s$  to  $1/60s$  you will decrease the exposure by 2EV. A change in EV can therefore represent a change in aperture, shutter speed or a mixture of both. It is a simpler and more useful way of referring to the essential effective combination when making exposure settings without referring to the implications and sometimes confusing aspects of specific shutter speeds or apertures.

As a practical example, if you are using 'exposure compensation', the settings are in EV's (often referred to as 'stops' in older descriptions) or fractions of EVs (or 'stops'). Therefore an exposure compensation of +1EV, for example, will provide 'one stop overexposure' and similarly an exposure compensation of -1/2EV, for example, will provide 'a half stop underexposure'.

See the chart in this manual for cross reference of EVs and their aperture/shutter speed equivalents

### ***Default setting / factory setting***

---

A standard setting that a device is set to in the first instance during manufacture and returns to if a setting change is halted or interrupted in any way.

### ***Half-press***

---

Some actions are initiated by pressing the shutter release button half way down. For example, the auto focus and light metering are both activated by a 'half-press'.

### ***Histogram***

---

In the case of digital cameras (and digital-image computer software), a histogram is a graphic representation of the range of tones from dark to light in an image measured over two axes.

### ***LCD***

---

Liquid Crystal Display. An electronic information panel. The grip and magazine both have LCD panels.

### ***LED***

---

Light Emitting Diode. Electronic devices used in information displays. The viewfinder display has LED's to the left and right of the integral LCD panel.

### ***Mid-grey / 18% grey***

---

An important point to be remembered is that all photographic exposure meters / light metering systems are calibrated to provide a reading that will reproduce a 'mid-grey or 18% grey tone' from the measured subject tone. This is an international photographic standard upon which all exposure calculations must be based. The H1D has very accurate and sophisticated exposure measuring modes. Pre-programmed information is taken into account via the metering system when calculations are automatically made. This provides a very satisfactory compromise for a host of photographic situations and many users will certainly be very satisfied with the consistently high quality of results. Nevertheless, some situations are either so technically difficult or open to interpretation that manual intervention is advised to ensure the desired result. Naturally, many seasoned users always prefer manual control but they base their calculations and decisions on much experience.

To illustrate this point, imagine the following example:

Pin two sheets of paper, one black and the other white, onto a grey wall. Take three exposures using an average light reading; a close-up of the black sheet, a close-up of the white sheet, and a distance shot of the whole wall including the two sheets. Without any manipulation, the first two exposures will produce a tone that is similar to the wall, namely, a grey tone; not black or white. The third exposure, however, will reproduce the wall as a grey tone while the two respective sheets

now appear as black and white respectively, as originally observed. However confusing this might at first seem, it is fundamental to mastering exposure calculations and exposure control. If you are at all unsure about this basic concept, you are strongly recommended to refer to a general photographic manual for a fuller explanation in order to obtain the maximum from your H1D.

---

### **OTF**

Off The Film - a literal description of the light measurement mechanics regarding flash exposure measurement.

---

### **Profile**

You can programme the H1D by the user to follow pre-determined 'profiles'. These profiles are combinations of modes, methods and settings (custom or default) that suit specific photographic situations. By using a personal profile - which you can create, name and save - the camera is immediately configured for a specific purpose without any need to check through the menus. This is a very rapid and secure way of working when repeatedly confronted with similar photographic situations.

As an example you might regularly take outdoor portraits of wedding couples with a long lens. You want a specific aperture to restrict depth-of-field and a fairly fast shutter speed to freeze any movement. You are concerned about the couple blinking during the exposure and so want to take several shots in succession, possibly with slight variations in

exposure settings for safety's sake so you might choose the bracketing option too. All these parameters can be preset and stored as a profile that is rapidly accessible.

---

### **Quick save**

When altering settings, a half-press of the shutter release button will cause a return to the standard screen and save the new setting at the same time.

---

### **Roll film**

The H1D uses two sizes of roll film that has different lengths; 120 and 220. 120 film generally produces 16 exposures per film and 220 film produces 32 exposures per film. ('Half-length 120' film, that has a very limited availability, will produce 8 exposures per film).

120 film is supplied on a spool complete with a paper backing that runs the full length of the film and extends beyond both ends. 220 film, on the other hand, just has paper at each end. In both cases, the film is gradually transported in the magazine from its original spool onto another so called take-up spool. The spool left empty then acts as the next take-up spool for the following film, and so on.

Care should always be taken in loading, unloading, and general storage. Try to avoid direct light sources when handling film in any way, in particular strong sunlight. Exposed film should be stored in dry and preferably light-tight conditions, and developed as soon as possible. Also avoid any sharp objects pressing against the film,

exposed or unexposed, as indelible marks can sometimes be caused. Please note any special conditions or restrictions regarding airport security x-ray devices or similar as they can potentially damage film (by fogging) in some cases.

### **Standard exposure**

---

A 'standard exposure' in the manual refers to the concept of technically correct in accordance with internationally accepted photographic measurement standards (see section on Mid-grey / 18% grey). This does not imply, however, that it would automatically be the preferred choice or be 'correct' according to the desired result. See section on Bracketing.

### **Standard screen**

---

To simplify the descriptions, reference is often made to a 'standard' screen regarding the menu. Apart from default settings, there is no standard setting in the normal sense and therefore you create your own 'standard', which of course can be changed at any time.

The 'standard' screen is therefore the one you have currently created and is the one visible on the LCD when photographing (except where a particular mode is in actual operation, such as self-timer, for example). In the pocket guide this 'standard' screen is symbolized by a 'home' symbol, that therefore represents the screen that you normally see when working.

### **TTL**

---

Through The Lens - a literal description of the light measurement mechanics. The advantage is that only the essential parts of the subject in front of the camera are included. Accessories such as filters, bellows, close-up rings, converters, etc that could affect exposure are also taken into account automatically with exposure evaluation (for general purposes).

### **Thumbnails**

---

Small, very low-resolution versions of a digital image used mainly for digital filing and management purposes.

### **Time out**

---

This is the time interval that a temporary setting is maintained for before it automatically returns to the original setting (default or custom).

### **Toggle function**

---

If a button has a 'toggle function', it has the ability to access two separate states simply by being pressed again. On the magazine, for example, if you want to change the data setting from 'on' to 'off', you would start by pressing the function selector twice to access the film length setting. Then, to change from 'on' you can press either the 'change up' or 'change down' button as both buttons have a 'toggle'

function. By pressing the same button again therefore, the setting will revert. This means you do not have to remember which button to press as they will both produce the same desired result in this case.

### **Zone (system)**

---

The Zone System is a method of combined exposure calculation/film development providing a great deal of tonal control. It was originally devised by Ansel Adams - the classic landscape photographer and Hasselblad user - and now exists in various forms for both black & white and colour photography. An integral part of the method includes the classification and grouping of any given scene into a range of nine (or ten) so-called zones, hence the name. The method produces a great degree of result predictability and image tone control.



Concerning the H1D, the word zone refers to the grouping and classification of various tones, where Zone V is the equivalent (whether in black & white or colour) to 18% mid-grey on a scale of Zone I (black) through Zone IX (white). See specific literature for a complete description of this method.

### **True exposure**

---

The effective shutter speed for a central lens shutter is defined as the length of time between the opening and closing when measured at the half height position when expressed in diagram form (see diagram). The fact that it will take some time to open and close the shutter will have an influence on the effective shutter speed as the lens aperture

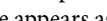
closes to its setting. The faster the shutter opens and closes, the less this influence will be. It is also follows that the influence will be greater on shorter shutter speeds.

With the lens at full aperture (largest opening), the amount of light at the film plane appears as illustrated by the  curve in the diagram. The effective shutter speed then becomes T1. If the lens is now closed down by one stop, the amount of light appears as illustrated by the  curve. The effective shutter speed is now increased to T2, which is longer than T1. The result is that the exposure is not reduced by exactly one stop (1EV), however, but slightly less. At the shorter shutter speeds, the exposure error can be as much as 0,5 – 0,8 EV.

The True exposure mode can compensate for this exposure error since the behaviour of the shutter is a known and predictable factor. At shutter speeds of 1/150 second or shorter (faster), the camera will shorten the shutter speed to compensate, as illustrated by the  curve. At the fastest shutter speeds, however, it is not possible to adjust the shutter speed and so the aperture is adjusted instead.

Although it is probably an infrequently used combination, please note nevertheless that the fastest shutter speed / minimum aperture combination cannot be adjusted by True exposure.

### **White balance**

---

The metering and consequent adjustment for variations in colour temperature.



## True exposure

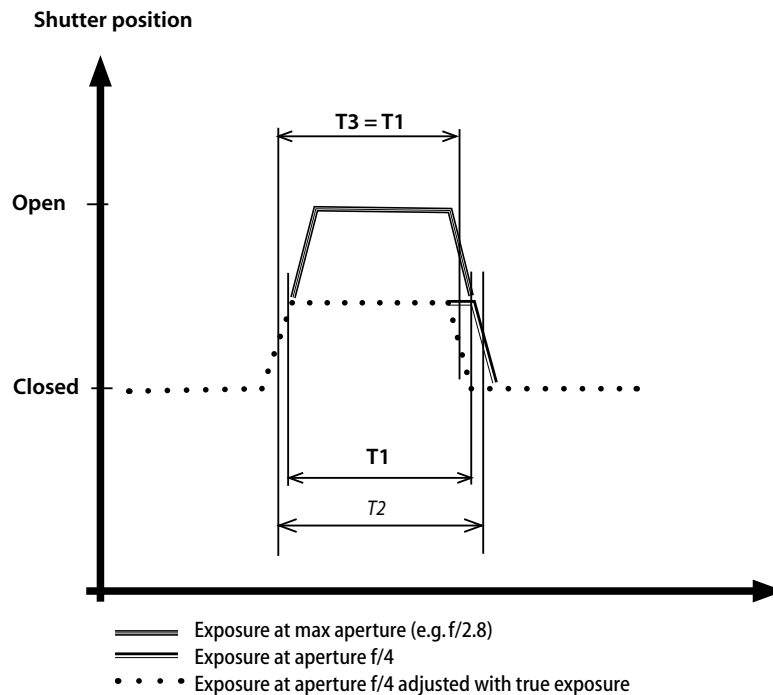

## Automatic exposure — P Mode

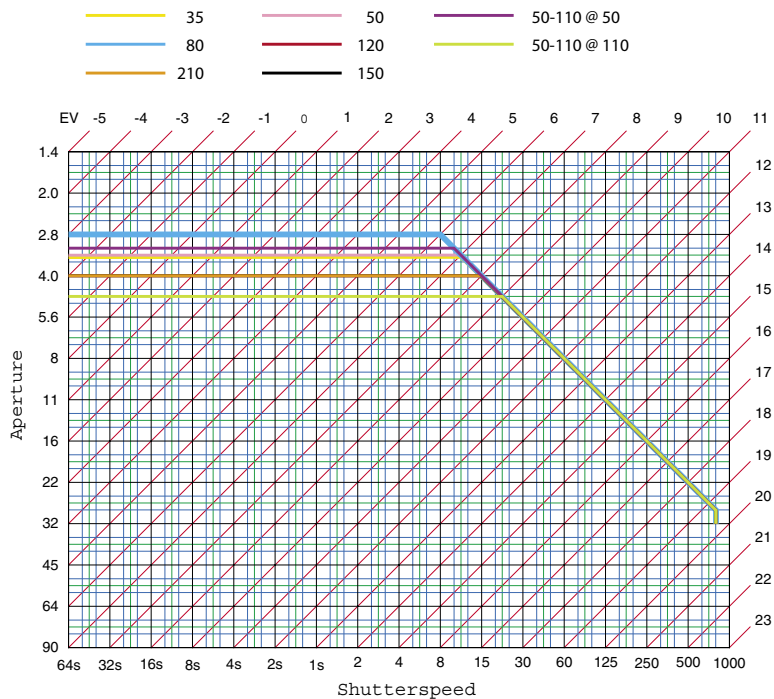

## Automatic exposure — Pv Mode

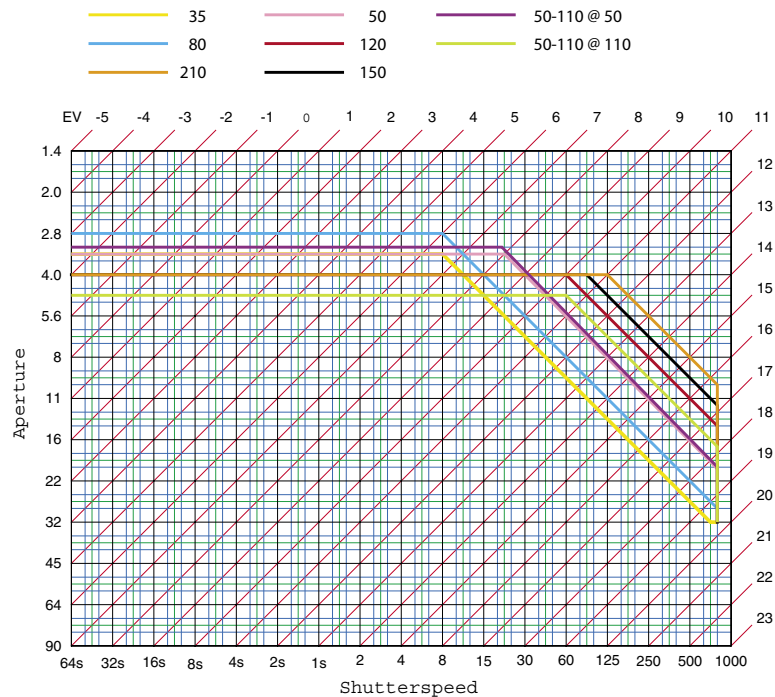

A downloadable PDF version of these charts in colour is available from our website: [www.hasselblad.com](http://www.hasselblad.com)

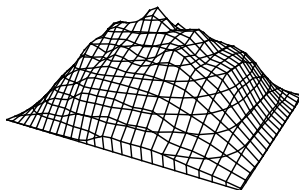
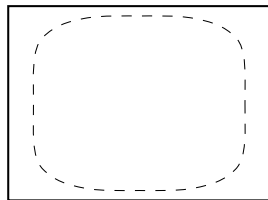
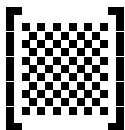

Average  
(45 x37 mm)  
≈ 70%

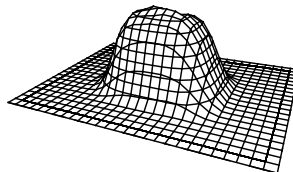
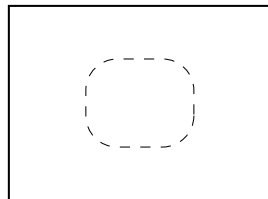
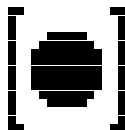

Centre weighted  
(23x20 mm)  
≈ 20%

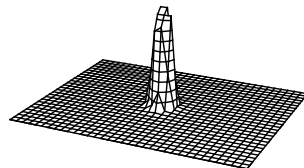
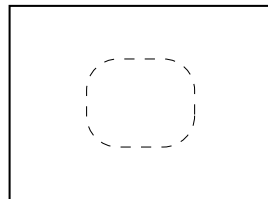
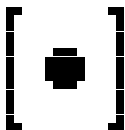

Spot  
(diameter 7.5 mm)  
≈ 2%

## Technical Specifications — H1D camera

<b>Camera Type</b>	Auto-focus, auto-exposure SLR camera with interchangeable magazines, viewfinders and lenses.
<b>Construction</b>	One piece stainless steel shell. Die-cast aluminium internal structure. Tripod sockets (1/4 and 3/8") and quick coupling tripod plate for rapid mounting.
<b>Lenses</b>	Hasselblad HC lenses with built-in electronically controlled shutter and aperture. Automatic or manual focusing with instant manual focus override. All H1D lenses have been especially designed to meet the exacting requirements of digital photography. Lens shades can be mounted in reverse for transport.
<b>Viewfinders</b>	A 90° reflex viewfinder, providing 100% field of view even when wearing eyeglasses, and built-in multi-mode light metering system. Image magnification 2.7. Integrated fill-in flash with guide number 12. Hot-shoe for automatic flash (Metz SCA3002 system / adapter SCA3902). Dot matrix LCD with presentation of all relevant information. Built-in diopter adjustment from -4 to +2.5D.
<b>Focusing</b>	Automatic and manual focusing with electronic focus aid in manual mode. Instant manual focus override. Automatic focusing using passive central cross type phase detection sensor. AF metering range EV 1 to 19 (ISO 100).
<b>Data imprinting</b>	Data is imprinted outside the image area. The user can specify which data is to be imprinted. Data can include any text the user desires, such as exposure data, time and date, the photographer's name, copyright symbols, etc.
<b>Film transport</b>	Automatic film advance at approx. 2 frames per second. Multi-exposure capability. Drive modes: single and continuous.
<b>Film format</b>	6x4.5 cm (actual size 55 x 41.5 mm).

<b>Film choice</b>	120 and 220 roll film.
<b>Shutter</b>	Electronically controlled lens shutter with speeds ranging from 18 hours to 1/800 of a second including B- and T-mode.
<b>Flash control</b>	TTL centre-weighted system. Can be used with the built-in flash or a wide variety of flashes compatible with the SCA3002 (Metz) system using adapter SCA3902. Film speed range ISO16 to 6400. Flash output can be adjusted for fill-in purposes independent of ambient light.
<b>Flash measurement</b>	The H1D has a built-in measurement system that measures flash light from non-TTL flashes, such as studio flashes.
<b>Film back</b> (op. accessory)	Interchangeable film backs available as optional accessory. Film insert for both 120 and 220 film types. Automatic film length setting. Built-in curtain type, dark slide. Automatic wind to frame one and wind off. Multi-mode data imprinting outside image area.
<b>Exposure metering</b>	Multi-mode exposure metering using 90° reflex viewfinder. Metering options are: spot (diameter 7.5 mm), centre weighted, and average. Metering range at f/2.8 and ISO100: Spot: EV2 to 21. Centre-weighted: EV1 to 21 Average: EV1 to 21.
<b>Auto bracketing</b>	Bracketing using predetermined number of exposures (2, 3 or 5) in 1/3, 1/2, or 1 EV step difference intervals.
<b>Interval timer</b>	Number of frames from 2 to 32 and interval from 1 second to 24 hours.
<b>Film speed</b>	Film speed range ISO 6 to 6400. Automatic setting with Barcode film.
<b>Displays</b>	The camera features two dot-matrix LCD's that provide clear and easy-to-understand information to the user. One is located on the grip and the other in the 90° viewfinder. The magazine has a segment based LCD.
<b>Focusing screen</b>	Bright Spherical Acute-Matte type D. Optional type with grid markings also available.

**Accessory connection**

Provided with two M5 threads and an electrical connector for accessories.

**Customization**

A large number of the H1D's functions can be customized by the photographer to suit specific styles or situations through the built-in menu system.

**User interface**

Both basic and advanced functions are set using buttons and control wheels on the camera body in conjunction with the graphic interfaces.

**Power supply**

A cassette for 3 CR-123 Lithium type batteries. Optional cassette with fixed rechargeable batteries

**External dimensions**

*All external dimensions are approximate and include fitted protective caps and covers.*

H1D Camera body: 89 x 155 x 117 mm (L,W,H) – 3.5 x 6.1 x 4.6 ins.

HV 90X Viewfinder: 140 x 78.5 x 52 x mm (L,W,H) – 5.5 x 3.1 x 2.0 ins.

HM 16-32 Film magazine: 64 x 98 x 84 mm (L,W,H) – 2.5 x 3.9 x 3.3 ins.

HC 2.8/80mm lens: 85 x 84 mm (L,W) (width 89 mm with lens shade mounted in reverse) – 3.3 x 3.3 ins.

**Weight**

*All weights are approximate and include fitted protective caps and covers, batteries and film.*

H1D Camera body: 820g – 28.9 oz.

HV 90X Viewfinder: 325 g – 11.5 oz.

HC 2.8/80mm lens: 500 g – 17.7 oz.

**Technical Specifications — H1D sensor unit**

<b>CCD size</b>	36.9 x 49 mm
<b>CCD resolution</b>	22,195.200 pixels (4080 x 5440)
<b>Bits per color</b>	16 bit (65,536 levels)
<b>Output size</b>	66 MB / 8 bit    132MB / 16 bit
<b>Light sensitivity</b>	ISO 50 – 400
<b>Max. exposure time</b>	32 sec.
<b>Capture rate</b>	2 sec.
<b>Features</b>	Colour preview, histogram feed, acoustic feed-back, back light, active temperature control, double duration circuit
<b>Weight</b>	Weight 0.5 kg
<b>Environmental Requirements</b>	Operating – 5 to 35°C (32 to 95°F) 20 to 80 % RH (no condensation) Storage – 5 to 35°C (32 to 95°F) 20 to 80 % RH (no condensation)



**Technical Specifications — Image Bank**

<b>Image Capacity</b>	850 images
<b>Mac/PC Connection</b>	FireWire (IEEE 1394)
<b>Battery</b>	- Type Sony InfoLithium L-series: NP-F550, NP-F750, NP-F960    Duration, constant shooting Up to 8 hours
<b>External Power Supply</b>	24V DC
<b>Power Consumption</b>	10 W
<b>Weight</b>	0.68 kg

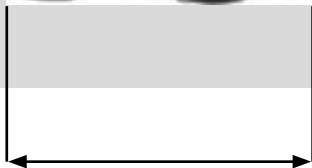

*approx. 155 mm*

*6.1 ins*

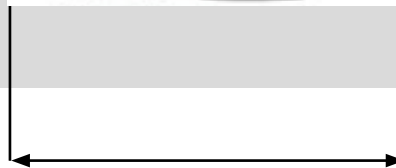

*approx. 207 mm (80 mm lens)*

*8.2 ins*



*approx.  
135 mm*

**H1D Data imprinting modes (with film magazine only)**

<b>Type 1</b>	Enhanced exposure information	Aperture Shutter speed Light metering mode Exposure mode Exposure adjustment (Not printed if value = 0) Flash symbol (If flash is used) Flash exp. adjustment (Not printed if value = 0) Focus mode Frame number Focal length	
<b>Type 2</b>	Basic exposure information	Aperture Shutter speed Exposure adjustment (Not printed if value = 0)	
<b>Type 3</b>	Date & Time	Date format: yy mm dd Time format: hh:mm:ss format: hh:mm am / pm	24 hour mode 12 hour mode
<b>Type 4</b>	Text & Date	User defined text max 37 chars Date	Not printed if text is longer than 33 characters
<b>Type 5</b>	Text & Info	User defined text max 37 chars Aperture Shutter speed Exposure adjustment (Not printed if value = 0)	Not printed if text is longer than 33 characters Not printed if text is longer than 33 characters Not printed if text is longer than 33 characters
<b>Type 6</b>	Text	User defined text max 37 characters	

BODY		DEFAULT SETTING (STANDARD PROFILE)	
Exp.mode		A (Aperture priority)	
LM mode		Centre weighted	
Exp. adjust		0	
Focus mode		AF-S	
Drive mode		S	
Flash sync		Normal (beginning of exp.)	
Flash adjust		0	
Self timer	delay	10 sec	
	Sequence	Mirror up / Delay	
	Mirror mode	Mirror goes down	
Bracketing	Frames	3	
	Sequence	Normal - over - under	
	EV diff	0,5 EV	
Interval timer	Frames	3	
	Interval	0 min 30 sec	
Custom options	1	Standby timeout	15 sec
	2	EV increment	0,5 EV
	3	User button function	None
	4	Control wheel direction	CW
	5	Flash ready exposure lock	Yes
		Imprint	
		MAGAZINE	
		Film speed	
		Film length	
		Data imprinting	
		Frame counter	
6	Film exposure lock	No	
7	Lens exposure lock	Yes	
8	Out of range exposure lock		No
9	True exposure	On	
10	Spot mode	Normal	
11	Focus aid in MF	Half press	
12	AF assist light	Ext. Flash	
13	Rear wheel quick adjust		Yes
14	Control lock	All controls	
15	Film wind-on	Direct	
16	Beeper	On	
17	Show histogram	Yes	
18	Interval & Selftimer	Exit	
19	AE-lock & Quick adjust	Exp. reset	
20	Show EV	Yes	
21	Show ISO	Yes	
type	Enhanced exposure information		
text	Hasselblad H1D		
		DEFAULT SETTING (STANDARD PROFILE)	
		Bar code setting	
		Film length	120 film, 16 frames
		Data imprinting	On
		Count up (Remain Off)	

## Problems, Equipment Care, Service & Guarantee

The H1D is a very sophisticated camera that relies on much information being passed and processed to and from each modular unit to produce the correct behaviour. It is therefore essential that reasonable care is taken in attaching, detaching and storing the viewfinder, lenses, extension tubes, magazines etc to ensure that the databus connections are not damaged or soiled in any way. Also when lifting or handling the camera try to always use the grip or strap and avoid holding the camera just by the magazine or viewfinder. Warning messages, for example 'The darkslide is closed' are easily addressed and remedied but 'Error' messages seen on the grip LCD require further attention as they denote a fault, temporary or otherwise. You should methodically investigate the situation to see for example whether the recent attachment of an accessory has coincided with the appearance of an error message. Standard procedure is to detach and re-attach the viewfinder, magazine etc ensuring that they are positioned firmly and correctly to see whether the problem disappears. Failing that, removal of the batteries or battery pack for about ten seconds or so will reset the camera's processors. Persistent error messages might well signify a more complex problem and you are advised to contact your nearest Hasselblad Authorized Service Center for advice. As well as the error message, a description of the camera's behaviour and an account of what action you were trying to take when it happened could be beneficial. Also, please remember

that the Center will almost certainly want to inspect all of the items that were involved when the error message first appeared, not just the camera body.

In certain situations, it is possible that the camera can be affected by a discharge of static electricity particularly if the area around the control buttons on the grip comes into contact with a conductive cord or material that is connected to earth, directly or indirectly (a lighting stand, for example). This might temporarily deactivate the camera though it does not cause any damage. Press the red ON/OFF button on the grip again to reactivate the camera.

If you use spare (standard or rechargeable) battery packs be particularly careful to use the supplied protective cap when storing. There is a potential fire risk if the contacts are short circuited across a conductive object (such as keys in a pocket, for example).

If a problem does occur you are advised not to attempt any repairs yourself. Some service operations require very sophisticated instruments to check, measure and adjust and there is a real danger of creating more problems than solving them if such attempts are made in any other way.

### EQUIPMENT CARE

A Hasselblad camera is designed to withstand the rigours of professional use in most environments. To avoid the possibility of damage however, it should be protected from the following:

**Extremes of temperature:** *High temperatures can have an adverse effect on both film and equipment. Try to avoid frequent and severe temperature changes. Be particularly careful in humid environments. Allow the equipment to acclimatize before assembly. Try to ensure the storage conditions in such environments are as dry as possible.*

**Dust and grit:** *Take care to prevent dust and grit from getting into your equipment. In coastal areas take measures to protect your equipment from sand and salt water spray. Dust on the lens glass and focusing screen can be removed with a blower brush or very soft lens brush if necessary. Smears on the lens glass should be treated with great caution. In some cases they may be removed with a high quality lens cleaning solution on a tissue but be careful not to scratch the lens or touch any of the glass surfaces with your fingers. If in any doubt, do not attempt to clean lens glass surfaces yourself but allow a "Hasselblad Authorized Service Center" to treat them.*

**Impact:** *Your equipment can be damaged by severe physical shocks so practical protective precautions should be taken. Some form of protective case or camera bag is advised for transportation.*

**Loss:** *Hasselblad equipment is much sought after and you should take obvious steps to prevent theft. Never leave it visible in an unattended car, for example. Separate and specific camera insurance cover should be considered by professional users.*

## **SERVICE**

*Return your equipment to a service centre for occasional checking and preventive maintenance to ensure optimal reliability. You can easily keep a check on service intervals by looking under 'Info' in the menu. If your camera is used constantly and intensively, regular periodic check-ups are recommended at one of the "Hasselblad Authorized Service Centers". They have the expert staff and specialised equipment necessary to ensure that your equipment remains in perfect working order.*

## **GUARANTEE**

*Provided that you bought your equipment from an authorized Hasselblad outlet, it is covered by an international guarantee for one year. The guarantee document and a registration card are supplied with the camera. Keep the guarantee document carefully, but fill in the registration card and return it to your Hasselblad distributor.*

## Warnings and Restrictions

- Read all instructions before attempting to use your new equipment.
- If your equipment requires service, please contact your Hasselblad dealer.
- Keep this and all electronic equipment out of children's reach.
- Do not lift or hold your camera by the viewfinder, sensor or film back.
- Do not attempt to open the sensor unit or Image Bank.
- Keep your H1D camera, Image Bank, and all other computer equipment away from moisture. If it becomes wet, disconnect from power and allow to dry before attempting to operate again.
- Always replace the protective covers on the H1D camera body, sensor unit or film magazine when separated.
- Store your H1D camera and Image Bank away from heat and moisture.
- Keep all wires connected to or from your H1D camera, Image Bank, and computer out of the way where they will not be tripped over.
- Never cover the devices ventilation openings.

### Using Flash Sync

The H1D "Flash Sync" connectors are specified for use with low voltage flash generators. Do not connect to older high voltage flash units.

The H1D sensor unit complies to ISO-10330 which limits voltages to 24V and currents to 100mA.

### External Power Supply

If you choose to power your system using an external power supply use only a type approved by Hasselblad for use with the H1D. See "Technical Specifications" for details

### Lithium Battery

- If you choose to power your system with a battery, use only batteries approved by Hasselblad for use with the H1D. See "Technical Specifications" details.
- Never short-circuit the battery terminals.
- CAUTION! Risk of explosion if battery is replaced by an incorrect type.

## **Disposal**

*If you need to dispose of the camera back, Image Bank and/or batteries, they must be delivered to the local waste plant.*

## **FCC Notice**

*This equipment has been tested and found to comply with the limits for a Class A digital device, pursuant to Part 15 of the FCC Rules. These limits are designed to provide reasonable protection against harmful interference when the equipment is operated in a commercial environment.*

*This equipment generates, uses, and can radiate radio frequency energy and, if not installed and used in accordance with the instruction manual, may cause harmful interference to radio communications.*

*Operation of this equipment in a residential area is likely to cause harmful interference in which case the user will be required to correct the interference at his own expense.*

## **General**

*The information in this manual is furnished for informational use only, is subject to change without notice, and should not be construed as a commitment by Hasselblad AB.*

*Hasselblad AB assumes no responsibility or liability for any errors or inaccuracies that may appear in this manual.*

*Hasselblad AB assumes no responsibility or liability for loss or damage incurred during or as a result of using Hasselblad software or products.*

*Hasselblad and FlexColor are trademarks of Hasselblad AB. Macintosh, Mac OS and FireWire are registered trademarks of Apple Computer, Inc. InfoLithium is a registered trademark of Sony Corporation.*

*Hasselblad AB reserves the right to make changes in descriptions, technical specifications and instructional information without prior notice and accepts no responsibility whatsoever, financial or otherwise, for any damages or losses incurred in connection with Hasselblad equipment.*

*© 2004 Hasselblad AB. All rights reserved.*

*Printed in Sweden 2004 (3013200)*



## Free Manuals Download Website

<http://myh66.com>

<http://usermanuals.us>

<http://www.somanuals.com>

<http://www.4manuals.cc>

<http://www.manual-lib.com>

<http://www.404manual.com>

<http://www.luxmanual.com>

<http://aubethermostatmanual.com>

Golf course search by state

<http://golfingnear.com>

Email search by domain

<http://emailbydomain.com>

Auto manuals search

<http://auto.somanuals.com>

TV manuals search

<http://tv.somanuals.com>