

*Hayterette*

---

CODE  
005C

## **OWNER'S HANDBOOK**

**(English Version)**

**FROM SERIAL NO: 005C001001**

**ISSUE 21.02.05**

**HANDBOOK: 005155 (REV .0.)**

## Main Features

1. Decal - Height of Cut
2. Decal - Caution
3. Serial Number Label
4. Exhaust Guard
5. Spark Plug Lead
6. Air Cleaner
7. Fuel Filler
8. Finger Guard
9. Oil Filler Cap & Dipstick
10. Handlebar Securing Knobs
11. Engine Start Grip
12. Throttle Control
13. Engine Stop Lever
14. Handlebar
15. Height of Cut Adjuster

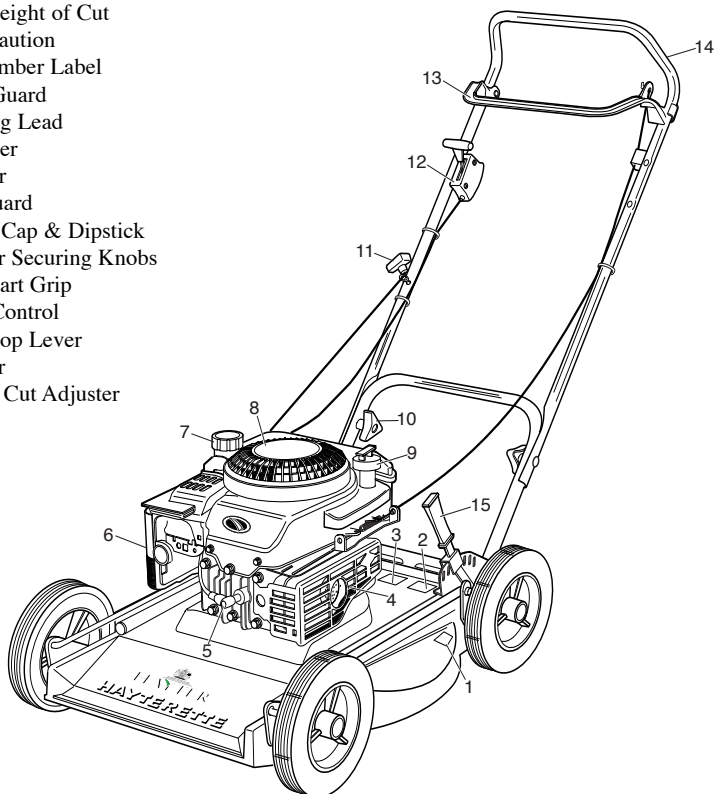

## Specifications

<b>Model</b>	<b>Code 005C</b>
<b>Engine</b>	Briggs & Stratton Quantum XTS 50
<b>Engine Type</b>	12F802-1325-01
<b>Engine / Cutterblades Speed</b>	3000 rpm
<b>Fuel Type</b>	Unleaded petrol
<b>Fuel Capacity</b>	1.5 litres
<b>Oil Type</b>	SAE 30 engine oil
<b>Oil Sump Capacity</b>	0.57 litres
<b>Cutting Width</b>	457mm
<b>Cutting Height</b>	13 - 70mm
<b>Overall Dimensions</b>	1285 x 535 x 960mm
<b>Dry Weight</b>	33 Kg

# HAYTER

MAKERS OF THE FINEST MOWERS

1ST Year (12 months)

We certify that this service has been carried out by an Authorised Hayter Service Dealer

Date: \_\_\_\_\_



# HAYTER

MAKERS OF THE FINEST MOWERS

1ST Year (12 months)

Owner's Name: \_\_\_\_\_

Serial Number: \_\_\_\_\_

Date: \_\_\_\_\_



**Note for dealer:** Please retain this voucher for your records.



# HAYTER

MAKERS OF THE FINEST MOWERS

2nd Year (24 months)

We certify that this service has been carried out by an Authorised Hayter Service Dealer

Date: \_\_\_\_\_



# HAYTER

MAKERS OF THE FINEST MOWERS

2nd Year (24 months)

Owner's Name: \_\_\_\_\_

Serial Number: \_\_\_\_\_

Date: \_\_\_\_\_



**Note for dealer:** Please retain this voucher for your records.





- 1.2 Main Features/Specifications**
- 1.5 Contents**
- 1.6 Introduction**
- 1.7 Warranty**
- 1.8 - 1.11 Safety Precautions**
  - 1.11 Safety Symbols**
  - 1.11 Decal Symbols**
  - 1.12 Assembling the Mower**
    - 1.12 - *Delivery Checklist*
    - 1.12 - *Handlebar*
    - 1.12 - *Engine Start Grip*
  - 1.13 Before Starting the Engine**
    - 1.13 - *Prevent Engine Damage*
    - 1.13 - *Oil Type*
    - 1.13 - *Check Oil Level*
    - 1.13 - *Fuel Type*
- 1.14 - 1.17 Operating The Mower**
  - 1.14 - *Controls*
  - 1.14 - *Starting Step 1*
  - 1.14 - *Step 2*
  - 1.14 - *Step 3*
  - 1.15 - *Travel*
  - 1.15 - *Turning*
  - 1.15 - *Stopping*
  - 1.15 - *Slopes*
  - 1.16 - *Height of Cut*
  - 1.16 - *Before Mowing*
  - 1.17 - *Heavy Growth*
  - 1.17 - *Cutterblade Operation*
  - 1.17 - *Non-Grassed Areas*
- 1.18 - 1.19 - *Lawn Care Calendar - Guide Only*
- 1.19 - *Lawn Stripes*
- 1.20 Maintenance Schedule**
- 1.21 - 1.26 Mower Maintenance**
  - 1.21 - *Engine*
  - 1.21 - *Throttle Cable Adjustment*
  - 1.21 - *Carburettor Adjustments*
  - 1.22 - *Oil Service*
  - 1.22 - *Air Cleaner Service*
  - 1.23 - *Spark Plug Service*
  - 1.23 - *Keeping Engine Clean*
  - 1.24 - *Deck Housing*
  - 1.24 - *Securing Nuts and Bolts*
  - 1.24 - *Control Cable*
  - 1.24 - *Lubrication*
  - 1.25 - *Cutterblade Removal*
  - 1.25 - *Cutterblade Assembly*
  - 1.26 - *Storage*
- 1.27 - 1.28 Trouble Shooting**
- 1.29 Declaration of Conformity**
- 1.30 - 1.31 Parts List**
  - 1.32 Parts list Diagram**
- 1.34. - 1.35 Notes**
- 1.36 Customer Info**

# INTRODUCTION

Thank you for purchasing a **Hayter** mower. The following pages are designed to help you gain safe and efficient service from your mower.

**IMPORTANT:** This 'Owners Handbook' should be regarded as part of the mower as it gives essential information regarding mower safety, operation, maintenance and specifications. Read and understand this handbook prior to operating your mower for the first time. Make sure you are familiar with all the controls and points of regular maintenance. If you have any doubts, consult your local **Hayter** authorised dealer who will be pleased to give you assistance.

**IMPORTANT:** This mower is designed solely for use in a domestic grass cutting environment. Use in any other way is considered as contrary to the intended use. Compliance with and strict adherence to the conditions of operation, service and repair as specified in this handbook also constitute essential elements of the intended use.

This mower should be operated, serviced and repaired only by persons who are familiar with its particular characteristics and who are acquainted with the relevant safety procedures.

The safety precautions listed in this handbook and all other generally recognised regulations on safety must be observed at all times.

Any arbitrary modifications carried out to this machine may relieve Hayter Limited of liability for any resulting damage or injury.

**Hayter** mowers are robustly constructed and designed for efficient economical performance under normal mowing conditions. Correct operation and maintenance will ensure a long and satisfactory service life. Prior to despatch from our factory every effort is made to ensure that your mower is delivered in perfect condition.

Throughout this handbook all references to **left** and **right** are as viewed from behind the handlebar, in the direction of forward travel.

This handbook is based on information available at the time of publication.

**HAYTER LIMITED** reserve the right to amend product specifications without prior notification.

## LIMITED WARRANTY

**Hayter Limited** warrants to the original user/purchaser that this unit shall be free from defects in material and workmanship under normal use and service for a period of **three years** from the date of purchase. The manufacturer of major proprietary components ie. engines, gearbox / transaxle (where applicable) furnish their own warranty and services are provided through their authorised network. To qualify for the full benefit of the warranty, the warranty registration card **must** be returned within **14 days** of purchase. Subject to the conditions and exclusions noted in this limited warranty, we shall at our option, repair or replace any warranted part during the applicable period. If you are in doubt or experience any difficulty, please consult a Hayter Authorised Service Dealer for clarification.

To qualify for the extended warranty (second and third year) of the **three year limited warranty** the machine **must** have annual services carried out by an Authorised Hayter Service Dealer. These chargeable services should be carried out within 12 and 24 months of the date of purchase.

Excluded from the extended warranty period are those items which are subject to normal wear and tear e.g. tyres, wheels, cutterblades, belts, cables, grassbags, brush/bristles, batteries and other consumable wearing parts.

**All** consumer machines which are fitted with a **genuine** Hayter friction disc as original equipment before use, are covered by a **Lifetime Warranty** against the engine crankshaft bending. **Note:** friction washers, blade brake clutch (B.B.C) units and other such devices are not applicable. Only machines fitted with a **genuine** Hayter friction disc, which are used in accordance with the recommended operating and maintenance procedures, are covered.

This warranty does not apply to any unit that has been tampered with, altered, misused, abused or used for hire, and will become invalid if non genuine Hayter parts are fitted. This warranty does not cover minor mechanical adjustments unless they are due to defective material or workmanship. Consult the Owner's Handbook or a Hayter Authorised Service Dealer for assistance when making these adjustments.

### **A warranty period of 90 days applies to machines used for commercial purposes.**

To make a warranty claim, return the unit to a Hayter authorised dealer along with proof of purchase stating the machine serial number and date of purchase. The service receipt(s) or this Owners Handbook with the 1st/2nd year service boxes fully completed, must be produced as proof of entitlement to the extended warranty period. Subject to the conditions and exclusions in this limited warranty, the authorised dealer will, at our option, repair or replace any warranted part within the duration of the warranty period.

This limited warranty gives you specific legal rights and is in addition to any statutory rights to which you may be entitled and your statutory rights are not affected by this warranty. If you need additional information concerning this written warranty, or assistance in obtaining services, please write to : **HAYTER LIMITED, Service Department, Spellbrook, Bishop's Stortford, Hertfordshire CM23 4BU**

**UK ONLY:** Details of your local **Hayter** authorised dealer are contained in Yellow Pages and the Hayter website [www.hayter.co.uk](http://www.hayter.co.uk) or contact contact:- Freephone 0800 616298.

# SAFETY PRECAUTIONS

## Safety Alert Symbol



This safety alert symbol indicates important safety messages. When you see this symbol be alert to the possibility of injury. Carefully read the following and inform others.

Your mower is perfectly safe if used correctly. Failure to observe the following precautions may result in serious injury.

## Training



Before using the mower read the owners handbook carefully. Pay particular attention to the safety precautions. Ensure that you are familiar with the controls and the proper use of the equipment. Learn how to stop the mower quickly in an emergency.

Never allow children or people unfamiliar with these instructions to use the mower.

Never mow while people, especially children, or pets are nearby.

Keep in mind that the user is responsible for accidents or hazards occurring to other people or their property.

## Preparation



While mowing, always wear substantial footwear and long trousers. Do not operate the equipment when barefoot or wearing sandals.

Thoroughly inspect the area where the mower is to be used and remove all objects which may be thrown by the machine.

**WARNING:** Petrol is highly flammable.

- Store fuel in containers specifically designed for this purpose.
- Add fuel before starting the engine. Never remove the cap from the fuel tank or add petrol while the engine is running or when the engine is hot. Allow the engine to cool for at least two minutes before refuelling.
- Do not attempt to start the engine if petrol is spilled or a smell of petrol is present. Move the mower away from the area of spillage and avoid creating any source of ignition until petrol vapours have dissipated.



# SAFETY PRECAUTIONS

## Preparation

- Always use fresh fuel. Stale fuel can block the carburettor and cause leakage.
- Replace fuel tank and oil tank caps securely.



A damaged cutterblade or loose fixing bolt are major hazards. Before use, always visually inspect the cutting mechanism to ensure that it is in good condition. A damaged cutterblade must be replaced immediately with a genuine Hayter replacement part

## Operation

Do not operate the engine in a confined space where exhaust fumes (carbon monoxide) can collect. Refuel outdoors only and do not smoke while refuelling.

Always pull the starter cord slowly until resistance is felt. Then pull the cord rapidly to avoid kickback and prevent hand or arm injury.

Mow only in daylight or good artificial light.

Avoid using the mower on wet grass, where feasible.

Always be sure of your footing on slopes.

Walk, never run.

Mow across the face of slopes, never up and down.

Exercise extreme caution when changing direction on slopes.

Do not mow excessively steep slopes of more than 20 degrees.

Use extreme caution when reversing or pulling the mower towards you.

Stop the engine before moving the mower across areas other than grass.

Never operate the mower unless the guards are securely in position and in good condition.

Do not change the engine governor settings or overspeed the engine.

Disengage the rear roller drive clutch before starting the engine.

Start the engine carefully, with feet well away from the cutterblade.



# SAFETY PRECAUTIONS

## Operation



Do not tilt the mower when starting the engine.

Do not put hands or feet near or under rotating parts.

Never pick up or carry the mower while the engine is running.

Never lift the rear deflector while the engine is running.

Never touch the exhaust/exhaust guard or cooling fins when the engine is hot.

### **Stop the engine and disconnect the spark plug lead:**

- Before clearing blockages or unclogging the discharge chute.
- Before cleaning/checking or working on the mower.
- After striking a foreign object. Inspect the mower for damage and ensure necessary repairs are made before re-starting.
- If the mower starts to vibrate abnormally (check immediately).

### **Stop the engine:**

- Whenever you leave the mower.
- Before refuelling.
- Reduce throttle control setting during engine shutdown.

## Maintenance & Storage



Keep all nuts, bolts and screws tight to ensure that the equipment is in safe operating condition.

Frequently check fuel lines and fittings for cracks or leaks and replace if necessary.

Never check for a spark when the spark plug is removed. (Use approved tester)

Inspect the exhaust periodically and replace if worn or leaking.

Never crank the engine with the spark plug removed.

Never start the engine with the air-cleaner or air-cleaner cover removed.

Never store the mower with petrol in the tank within an enclosed area where fumes may reach an open flame or spark.

# SAFETY PRECAUTIONS

## Maintenance & Storage

Allow the engine to cool before storing in any enclosure. To reduce the fire hazard, keep the engine and the surrounding deck area free of grass, leaves, or excessive grease.

Check the rear deflector and grassbag frequently for wear or deterioration. Replace worn or damaged parts for safety.

If the fuel tank has to be drained, this should be done outdoors and when the engine is cool.

Wear strong work gloves when removing and reassembling the cut-terblade.

Always replace worn or faulty parts with genuine Hayter parts.



## Safety Symbols

Safety Alert - Be aware to the possibility of injury.



Danger of severing toes or fingers in cutting mechanism.

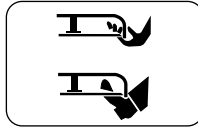

Danger of being hit by thrown objects.



Carefully read the Owners Handbook before using the machine.

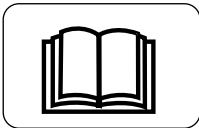

Stop engine and remove spark plug lead before working on the mower.

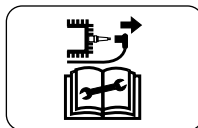

Keep bystanders at a safe distance from the mower.

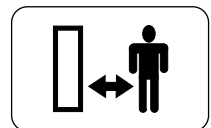

## Decal Symbols

Engine Stop (Symbol)

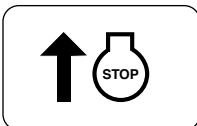

Height of Cut Adjustment (Symbol)

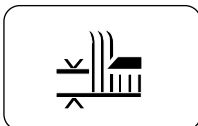

Throttle Control (Symbols)

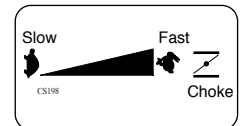

# ASSEMBLING THE MOWER

## Delivery Checklist

Remove the mower from the packaging and check that the following items have been supplied correctly. If any items are missing contact your local Hayter dealer.

1. Engine Handbook.

## Handlebar

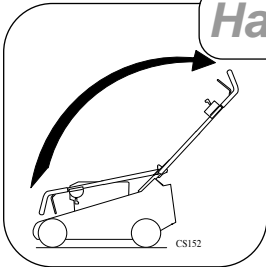

Unscrew the handlebar securing knobs sufficiently to allow the handlebar to pivot. Move the engine stop lever away from the engine to avoid damage and unfold the handlebar to the operating position. Make sure the knobs are assembled to the outside of the handlebar and tighten to secure in position.

**Take care to ensure that the control cables do not become snagged at the pivot point.**

## Engine Start Grip

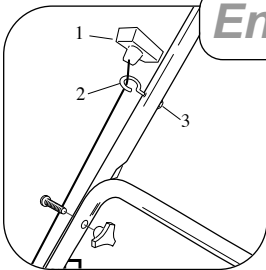

Operate the engine stop lever towards the handlebar and very slowly pull the engine start grip (1) away from the engine until there is sufficient slack in the rope to enable it to be threaded into the rope guide (2). Release the start-grip until it rests against the rope guide as shown. Finally tighten the nut (3) to secure the rope guide.

# BEFORE STARTING THE MOWER

## Prevent Engine Damage

To prevent engine damage the engine is shipped without oil or petrol. The engine must be filled with the correct grade of oil and petrol before starting the engine.



## Oil Type

Always use high quality detergent oil classified "For service SE, SF, SG" SAE 30 oil. Never use additives with recommended oils. SAE 10W-30 multigrade oil may be used, but this will result in higher engine operating temperatures with consequential high oil consumption. It is imperative that the oil level is checked more frequently if this grade of oil is used in order to guard against serious engine damage. To prolong the life of your engine it is important that the oil is changed after the first 5 hours of use - refer to 'Maintenance Schedule'.



## Check Oil Level

Clean around the oil filler cap before removing. With the mower on a level surface, unscrew and remove the oil filler - dipstick. Wipe oil from it with a clean cloth. Screw the oil filler - dipstick back in place, then unscrew and remove it to check the oil level.

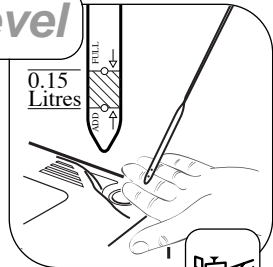

The oil level is correct when it is at the **full** mark on the dipstick.  
**DO NOT OVERFILL.**

## Fuel Type

Always use clean, fresh unleaded petrol. Purchase fuel in quantities that can be used within 30 days. Never mix oil with petrol. For added engine protection Briggs & Stratton recommend the use of their fuel additive which is available from an authorised Briggs & Stratton service dealer.

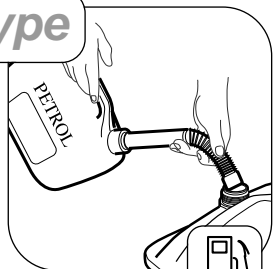

**Fill to base of neck to allow for fuel expansion. Do not overfill the fuel tank.**

# OPERATING THE MOWER

## Controls

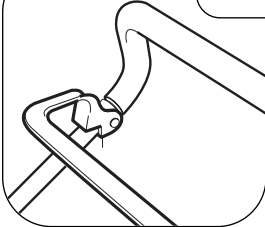

Operate all control levers several times and ensure that the cables move freely. Check that the engine stop lever returns freely to its rest position when released.

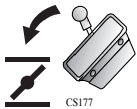

Whilst operating the engine throttle mechanism slight resistance should be felt when moving the lever to the 'choke'  position.

## Starting - Step 1



CS177



Move the throttle control lever to the 'choke'  position before starting a cold engine. Move the throttle control lever to the 'fast'  position before starting a warm engine.

## Step 2

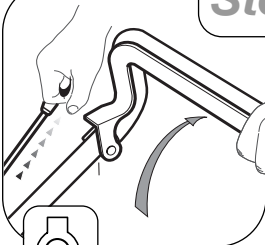

Stand behind the mower and hold the handlebar together with the engine stop lever with your left hand. With your right hand hold the engine start - grip and pull slowly until resistance is felt, then pull rapidly to crank the engine. Carefully return the start grip to the storage position when the engine starts.

If the engine does not start after 5 attempts - refer to "Trouble Shooting".

**The engine stop lever must be held firmly against the handlebar to start and keep the engine running. If the engine stop lever is released the engine will stop.**

## Step 3



CS181



Allow the engine to warm up and move the throttle lever to the 'fast'  position after starting a cold engine.

**To prevent damage never pull the engine start grip when the engine is running.**

# OPERATING THE MOWER

## Travel

**Forward travel:** Hold and push against the handlebar with both hands to move the mower forwards.

**Reverse travel:** Hold and pull against the handlebar with both hands to reverse the mower towards you.

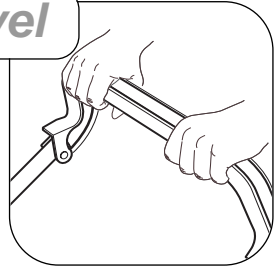

## Turning

To make a wide turn steer the mower with the handlebar in the direction required.

To make a tight turn apply downward pressure on the handlebar to raise the front wheels just above ground level and steer in the required direction.

**To prevent accidents do not raise the front of the mower excessively when making a turn. Never raise the rear of the mower when the engine is running.**



## Stopping

Release the engine stop lever and ground drive clutch lever on auto drive models and push the throttle control lever to the 'slow' position.

**If the engine fails to stop, move the throttle lever to the 'slow' position and disconnect the spark plug lead.**

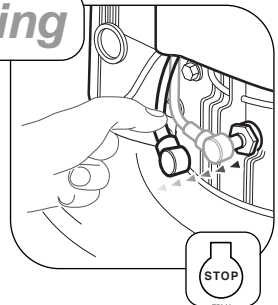

## Slopes

**To prevent engine damage do not use the mower on slopes greater than 20 degrees.**

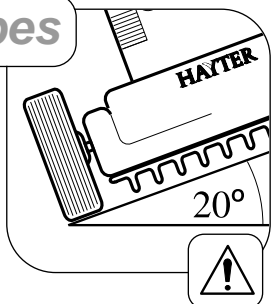

# OPERATING THE MOWER

## Height of Cut

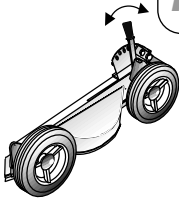

CS287



Move the height of cut lever sideways to disengage it from the locking notch, then push forwards to lower or pull backwards to raise the height of cut. Release the lever in the required position and ensure that it locks firmly into one of the seven notch settings.

Always select a height of cut to suit operating conditions. Prevent engine overloading and blockages by avoiding low cuts in long grass conditions. Be prepared to make two cuts when the grass is long.

## Before Mowing



To prevent accidents thoroughly inspect the area and remove all objects which when contacted by the mower cutterblade could become dangerous projectiles. Inspect the area for hidden obstructions which when contacted by the cutterblade could risk health and safety. Remember the location of these obstructions and ensure that you mow around them.



# OPERATING THE MOWER

## Heavy Growth

Areas of heavy growth should be mown without collecting the clippings. If collection is required, first mow the area without the grassbag at the maximum height of cut setting. Allow the grass clippings to dry out and then mow the area at the maximum height of cut setting with the grassbag fitted. Reduce the height of cut and mow the area again as necessary until the required finish is obtained.

To prevent grass damage do not remove more than one third of grass height in one cut.

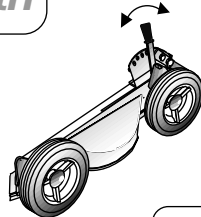

## Cutterblade Operation

Hayter balanced 'C' type cranked cutterblades are fitted to this machine. They are designed to swing on the shoulder of the Cutterblade bolt when encountering a fixed object. Keep cutterblades sharp and ensure they are secured correctly.

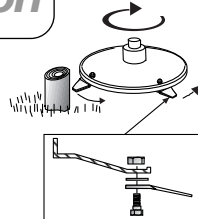

## Non-Grassed Areas

When moving the mower across non-grassed areas, stop the engine and set the mower to the maximum height of cut to protect the cutting mechanism.

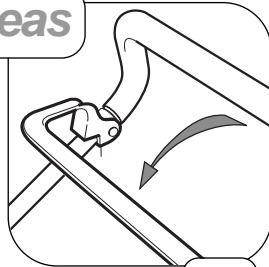

# LAWN CARE CALENDAR

To be used as a guide only.

## January

---

There is very little work to do this month apart from brushing away leaves. Keep off the grass if frozen or waterlogged.

## February

---

Rake the grass thoroughly. Spike the lawn to aerate and stimulate soil organisms and root growth and apply lawn sand if necessary.

## March

---

The yearly lawn work programme really starts this month. As soon as the ground conditions are suitable, the first cut can be made. The first cut should merely “top” the grass as close cutting at this stage could result in severe yellowing or browning. Two cuts are generally sufficient this month.

## April

---

Mow often enough to stop grass growing away. Dig out patches of coarse grass or resistant weed. Re-seed bare patches.

## May

---

Keep mowing increasing the frequency as required. Treat with selective weed killers or combined weed/feed preparations if you did not feed the lawn in April.

## June

---

Summer mowing should now be under way. It should be necessary to mow the lawn twice a week. Raking before mowing is important this month as the combined action keeps runners of clover under control. Water the grass if necessary, and remember to soak thoroughly.

## July

---

Treat the grass with the second application of fertiliser or weed killer/fertiliser. Water when necessary and rake occasionally. As a general rule the grass clippings should be removed each time you mow. If weather conditions are dry and hot and the grass is weed free, leave the clippings on the lawn to help maintain ground moisture.

# LAWN CARE CALENDAR

## August

Keep mowing regularly and watering as necessary. Fill any cracks caused by drought with a mixture of sharp sand and soil. In dry weather conditions leave the grass longer to help retain ground moisture.

## September

Raise the height of cut to allow the grass to thicken and protect the roots from the winter frost and snow.

## October

Rake out the thatch from the turf and spike the lawn to assist in drainage. Brush in peat and sharp sand.

## November

Use a stiff broom to disperse worm casts before mowing. Keep turf free from leaves.

## December

Apart from brushing away leaves, December is a slack end of a busy year. Keep off the lawn if it is very wet or frozen.

## Lawn Stripes

The way to achieve a neat striped effect is for the lawn being cut in parallel stripes, alternate stripes being mown in opposite directions. A much more important routine is to cut at right angles to the line of the previous mowing. If the work has been carried in a north-south line, then the next cutting should be in an east-west direction. The cross-cutting keeps down the coarse weed grasses.

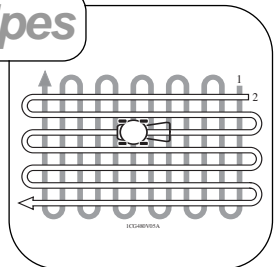

**To prevent grass damage do not remove more than one third of the grass height in one cut.**

# MAINTENANCE SCHEDULE



**To prevent accidents stop the engine disconnect the spark plug lead before attempting to carry out maintenance procedures on the mower.**

Follow the hourly or calendar intervals, whichever occurs first. More frequent service will be required if working for prolonged periods under dusty, dry conditions, or when airborne debris is present or after extensive operation cutting tall, dry grass.

## *First 5Hrs*

- After the very first five hours change the engine oil

## *Daily*

- Check the oil level
- Remove grass debris from around the engine, exhaust/exhaust guard and air ways in the top cowl and underside of the deck housing.
- Check the condition of guards and safety devices.
- Check condition of cutterblades.

## *25Hrs or Every Season*

- Change the engine oil if continuously operating under heavy load or high ambient temperature.
- Service the air cleaner.
- Lubricate wheels, pivot points and linkages and grease the inner control cables at point of entry and exit from their outer casing.
- Sharpen the cutterblade.

## *50Hrs or Every Season*

- Change the engine oil.

## *50Hrs or Every Season*

- Clean the engine cooling system. Clean more often under dusty conditions or when airborne debris is present or after prolonged operation whilst cutting tall, dry grass.
- Replace the spark plug.

# MOWER MAINTENANCE

To prevent accidents stop the engine and disconnect the spark plug lead before attempting to carry out maintenance procedures on the mower.



## Engine

1. Finger Guard
2. Carburettor
3. Spark Plug / Lead
4. Exhaust Guard
5. Exhaust
6. Oil filler Cap/ Dipstick
7. Start Grip
8. Fuel Cap
10. Air Cleaner

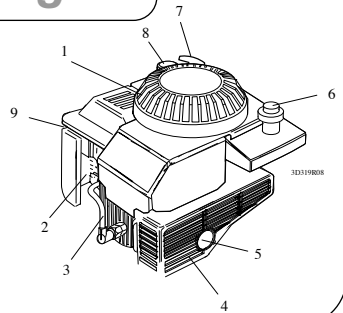

## Throttle Cable Adjustment

Loosen the outer cable clamp screw (1) and move the governor control lever (2) to the left as far as possible. Insert a large, flat blade screw driver (3) into the slot in the engine control bracket (4) at the angle shown. Push the governor control lever to the right until it just touches the screw driver blade. Move the throttle control lever to the 'fast' position (not the 'choke' position) and re-tighten the outer cable clamp screw. Replace the engine cowl.

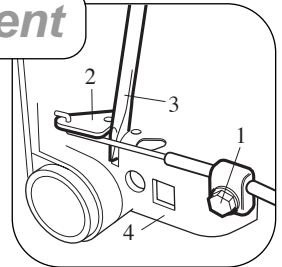

## Carburettor Adjustments

Should only be made by an authorised Briggs & Stratton dealer. Under no circumstances should the engine be adjusted to run at a speed in excess of that shown on the Declaration of Conformity.

# MOWER MAINTENANCE

## Oil Service

Check the oil level daily before starting the engine and ensure that the correct oil level is maintained. Refer to-'Before Starting the Mower' for oil checking and filling instructions.

Change the engine oil after the first 5 hours of operation and thereafter according to the 'Maintenance Schedule':-

1. Drain fuel by running the engine until the fuel tank is empty.
2. Remove the spark plug lead.
3. Allow the engine to cool.
4. Drain the oil while the engine is warm.(Not hot)
5. Tip the mower over on to its left hand side thus ensuring that the air cleaner is kept uppermost **to prevent engine damage.**
6. Remove the oil filler dipstick and drain the oil into a suitable container.
7. Refill with new oil of the recommended SAE viscosity grade. (Refer to-'Before Starting the Mower')

## Air Cleaner Service

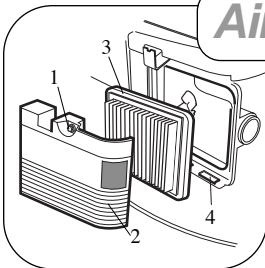

To service the air cleaner, loosen screw (1) and remove cover (2).

Remove cartridge (3) and clean by tapping gently on a flat surface. If very dirty, replace.

- Do not use petroleum solvents.
- Do not use pressurised air.
- Do not oil the cartridge.

After servicing, install the cartridge into the cover. Insert the tabs on the bottom of the cover into the slots in the bottom of the base (4). Tilt the cover upwards and securely tighten the screw to the base.

# MOWER MAINTENANCE

## Spark Plug Service

Use only Briggs & Stratton spark tester (1) to check for a spark as shown in the diagram.

Replace the spark plug every 100 hours or every season, whichever occurs first. A spark plug wrench is available from any authorised Briggs & Stratton service dealer.

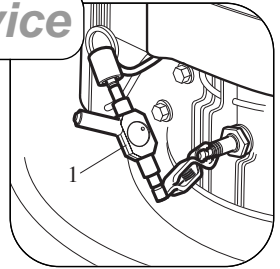

Check the spark plug gap with a feeler gauge and set at 0.76mm.



## Keeping Engine Clean

Remove all grass and debris from the engine including the exhaust/exhaust guard, the air ways in the top cowl and the surrounding deck areas on a daily basis after use. Never spray the engine with water during cleaning. Water can contaminate the fuel. Always clean with a brush or compressed air.

Grass and debris may clog the engine's air cooling system especially after prolonged operation while cutting tall, dry grass. The internal cooling fins and surfaces may require cleaning to prevent overheating and engine damage. We recommend that this service be carried out by an authorised Briggs and Stratton dealer.

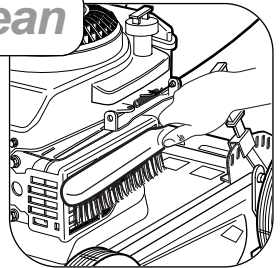

# MOWER MAINTENANCE

## Deck Housing

Remove grass debris from the top and underside of the deck housing immediately after use.

**To prevent accidents fertilisers and top dressings are particularly corrosive. Thoroughly clean the mower deck immediately after use on treated grass and store well away from corrosive materials.**

## Securing Nuts & Bolts



Regularly check that all securing nuts and bolts are tight. Replace missing or damaged items immediately.

## Control Cables

Apply a good quality medium grease to the inner control cables every 25 operating hours at the point of entry and exit from their outer casings.

**IMPORTANT: ALWAYS replace damaged cables.**

## Lubrication

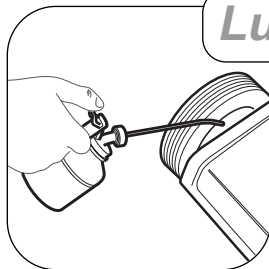

Lubricate the wheels, pivot points and linkages with engine oil every 25 operating hours.

Apply a good quality medium grease to the inner control cables at the point of entry and exit from their outer casing.



# MOWER MAINTENANCE

## Cutterblade Removal

**WARNING - PREVENT ACCIDENTS:** Never work on the cutterblades unless the spark plug lead has been removed. The cutterblades have sharp edges. **ALWAYS** wear strong gloves to protect your hands when working on the cutterblades. **DO NOT** rotate tools towards the cutting edges to avoid the risk of injury should the tool slip. **ALWAYS** use genuine Hayter replacement parts.

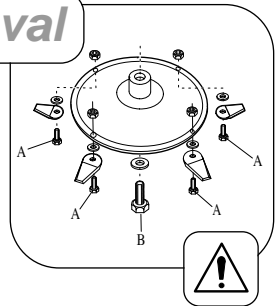

The condition of the cutterblades and the mounting arrangement should be checked regularly for signs of wear or damage. Ensure that the cutterblades are not bent or cracked.

Regularly check that the bolts securing the cutterblades and friction disc are secure.

A - Cutterblade bolt torque setting 19Nm (14lbs.ft).

B - Bottom plate bolt torque setting 54Nm (40lbs.ft).

A damaged cutterblade will cause the cutting mechanism to be out of balance and excessive vibration will occur which may lead to breakage. **DO NOT** use unbalanced cutterblades.

Replace the cutterblades every 2 years or sooner if excessively worn or damaged.

Run the engine until the fuel tank is empty. **Remove the spark plug lead** and allow the engine to cool. Turn the mower on its left hand side and ensure that the air cleaner side of the engine is uppermost. Remove the cutterblade nuts and bolts to remove the four cutterblades.

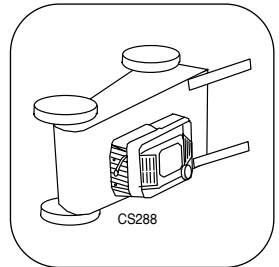

**WARNING- PREVENT ACCIDENTS:** **ALWAYS** renew all four cutterblades to ensure the cutting mechanism is balanced, **NEVER** replace cutterblades individually. **ALWAYS** use new bolts, nuts and washers when fitting new cutterblades.

## Cutterblade Assembly

Assemble the cutterblades such that they are below and pointing away from the bottom plate. Tighten the cutterblade nuts and bolts to a torque of 19 Nm.

Item No.	Description	Part No.	QTY
1	Blade	2779	1 Kit
2	Bolt	590	1 Kit
	Washer		
	Nut		

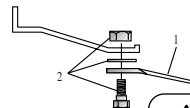

## Storage

---

To store the handlebar unscrew the 2 small securing knobs sufficiently to allow it to be pivoted forwards to rest against the mower. Take care to ensure that the control cables do not become snagged at the pivot point and depress the engine stop lever to prevent it being damaged through contact with the engine spark plug.

Engines stored in excess of 30 days need to be protected with Briggs & Stratton fuel additive or drained of fuel to prevent gum from forming in the fuel system or on essential carburettor parts. To ensure your mower is maintained in good working order it is important that the following procedure is adopted. Refer to the Maintenance section as necessary.

Drain fuel from the engine by operating the engine until it stops.

Disconnect the spark plug lead.

Change the engine oil.

Remove the engine spark plug and pour 15ml of engine oil into the engine cylinder and replace the spark plug. Do not exceed the stated volume of oil as engine damage may occur on re-starting. **Do not replace the spark plug lead.** Slowly pull the engine start - grip once to crank the engine. This will distribute the oil and help prevent engine corrosion.

Clean grass and debris from the engine cylinder, cylinder head cooling fins, under top cowl, and around and behind exhaust/exhaust guard.

Clean all other areas of the mower and ensure that the grassbag is clean.

Lubricate the mower.

Treat metal parts with a water repellent anti-corrosion product.

Cover the mower with a protective sheet and store it in a dry, ventilated area.

# TROUBLE SHOOTING

<b>PROBLEM</b>	<b>POSSIBLE FAULT</b>	<b>REMEDY</b>
Engine will not turn over	Engine stop lever released	Operate the engine stop lever
	Incorrect oil level	Check oil level
	Obstruction under deck	Remove obstruction
Engine smokes	Excess oil level	Check oil level
	Air cleaner plugged	Service air cleaner
Engine runs then stops	Fuel starvation	Fill fuel tank
	Fuel cap vent blocked	Clean fuel cap vent
Engine will not start	Engine under load	Raise height of cut
	Fuel starvation	Fill fuel tank
	Incorrect/contaminated fuel	Drain fuel tank and fill with correct fuel
	Spark plug lead disconnected	Connect spark plug lead
	Engine cold	Set throttle to 'choke' position
	Engine brake not released	Operate engine stop lever.
	Faulty spark plug	Clean and adjust gap or replace
Engine runs rough	Spark plug lead becoming disconnected in use	Connect spark plug lead
	Faulty spark plug	Clean and adjust gap or replace
	Air cleaner blocked	Service air cleaner
	Incorrect/contaminated fuel	Drain fuel tank and fill with correct fuel

# TROUBLE SHOOTING

<b>PROBLEM</b>	<b>POSSIBLE FAULT</b>	<b>REMEDY</b>
Engine vibrates excessively	Mounting bolts loose	Tighten bolts
	Cutterblade bolt loose	Tighten bolt
	Cutterblades out of balance	Replace cutterblades
	Engine crankshaft bent	Consult your dealer
Uneven cut	Undulating ground conditions	Change direction of travel
	Cutterblades worn	Renew cutterblades
	Cutterblades out of balance	Renew cutterblades
	Wheels damaged	Inspect and replace as necessary
Mower is hard to push	Cut height too low	Increase cut height
	Wheels damaged	Inspect and lubricate or replace as necessary

# DECLARATION OF CONFORMITY

## EC DECLARATION OF CONFORMITY

HAYTER LIMITED,  
Spellbrook, Bishop's Stortford, Herts CM23 4BU ENGLAND



### declare that the lawnmower:

Models:	Hayterette
Machine Type No.	CODE 005C
Category:	Push
Type:	Pedestrian Rotary
Engine manufacturer:	Briggs & Stratton
Speed of rotation:	3000 rpm
Width of cutting device:	457 mm
Speed of rotation of the cutting device:	3000 rpm

Complies with the provisions of Directive: 98/37/EC Essential Health & Safety Requirements Relating to the Design & Construction of Machinery and Safety Components, as amended and the regulations transposed into national law.

Also Directive 89/336/EEC Electromagnetic Compatibility, as amended and the regulations transposed into national law.

Also Directive 2000/14/EC Noise emission in the environment by equipment for use outdoors, and the regulations transposed into national law procedure applied for the conformity assessment: ANNEX VI, procedure 1.  
Notified Body: Sound Research Laboratories Ltd. Holbrook House, Little Waldingfield,  
Sudbury, Suffolk, ENGLAND  
Notified body identification No: 1088

Measured sound power level:	98 dB(A)
Guaranteed sound power level:	96 dB(A)

Authorised Signatory:

Signed

Date: 26.11.04

Declaration done and Technical Documentation kept at:

S.A. Maryniak  
(Technical Director)

HAYTER LIMITED,  
Spellbrook, Bishop's Stortford,  
Herts CM23 4BU ENGLAND

## VIBRATION INFORMATION

The Lawnmower Vibration level at the operator contact position, measured in accordance with European Standard EN836-Handlebars. **CODE 005C = 7.5 ms<sup>-2</sup>**

# PARTS LIST

NO.	DESCRIPTION	PART NO.	QTY	ITEM NOTE
1	Pin - Pivot	340182	2	
2	Washer - 19mm Nylon	09688	6	
3	Lever - Engine Stop	340179	1	
4	Screw - 6mm x 20	09687	2	
5	Decal - Grass Blade	410064	1	
6	Handlebar - Upper	305145W	1	
7	Guide - Rope	305093	1	
8	Throttle Control & Cable	005142	1	
9	Screw - M5 x 35mm Taptite	09358	3	
10	Cable - Engine Brake	005102	1	
11	Tie - Cable	3966	4	
12	Handwheel - Triangular	226013	2	
13	Bolt - M8 x 45 Handlebar	226024	2	
14	Handlebar - Lower	005121W	1	
15	Footguard	005139W	1	
16	Nut - M8 Nyloc	09442	6	
17	Washer - M8 Plain	09475	6	
18	Bolt - M8 x 45	09654	2	
19	Washer - M6 Plain	09472	1	
20	Nut - M6 Nyloc	09438	1	
21	5/16" x 5/8" O/D Washer	09266	4	
22	Engine Compliance	410007	1	
23	Bearing Block - Upper	005146	2	
24	Bearing Block - Lower	005145	2	
25	Axle - Rear Assembly	005119	1	
26	Pin - Spring	254013	2	
27	Flap - Rear	005097	1	
28	Grommet - Rubber	6289	2	
29	Bearing	5221	8	
30	Wheel - 8"	005095	4	Inc item 29
31	Nut - 1/2" UNF Nyloc	4486	4	
32	Pin - Split 1/2" x 3/32" Diameter	09303	4	
33	Connecting Rod	005135	2	
34	Axle - Front W/A L/H	005116	1	
35	Bolt - Axle Pivot	005129	2	
36	Spring - Disc	4912	2	
37	Cutterblades Bolt - Kit (set of 4)	590	1	Inc items 55,57 & 58
38	Axle - Front W/A R/H	005115	1	
39	Bolt - M8 x 75	09372	4	
40	Clip - Spring Handle Retaining	4884	1	

# PARTS LIST

NO.	DESCRIPTION	PART NO.	QTY	ITEM NOTE
41	Handle Grip - Black	4097	1	
42	Rivet	09320	1	
43	Hub Cap	219143	4	
44	Plug - Tube	320048	2	
45	Washer - 3/8" Spring S/C	09273	1	
46	Screw - 3/8" UNF x 1" Long	09114	1	
47	Nut - 3/8" UNF Nyloc	09216	2	
48	Key - Woodruff	1662	1	
49	Decal - Hayter	410087	1	
50	Decal - Height of Cut	320006	1	
51	Decal - Caution	219189	1	
52	Decal - Serial No.	-	1	
53	Screw 3/8" UNF x 1 1/2" Long	09349	3	
54	Deck	005140V	1	
55	Cutterblade Bolt	6306	4	
56	Cutterblade 'C' Type (set of 4)	2779	1	
57	Plain Washer 3/8" x 1 1/4"	02394	6	
58	Nut - 3/8" UNF Nyloc	09215	4	
59	Bottom Plate	2811	1	

# PARTS LIST

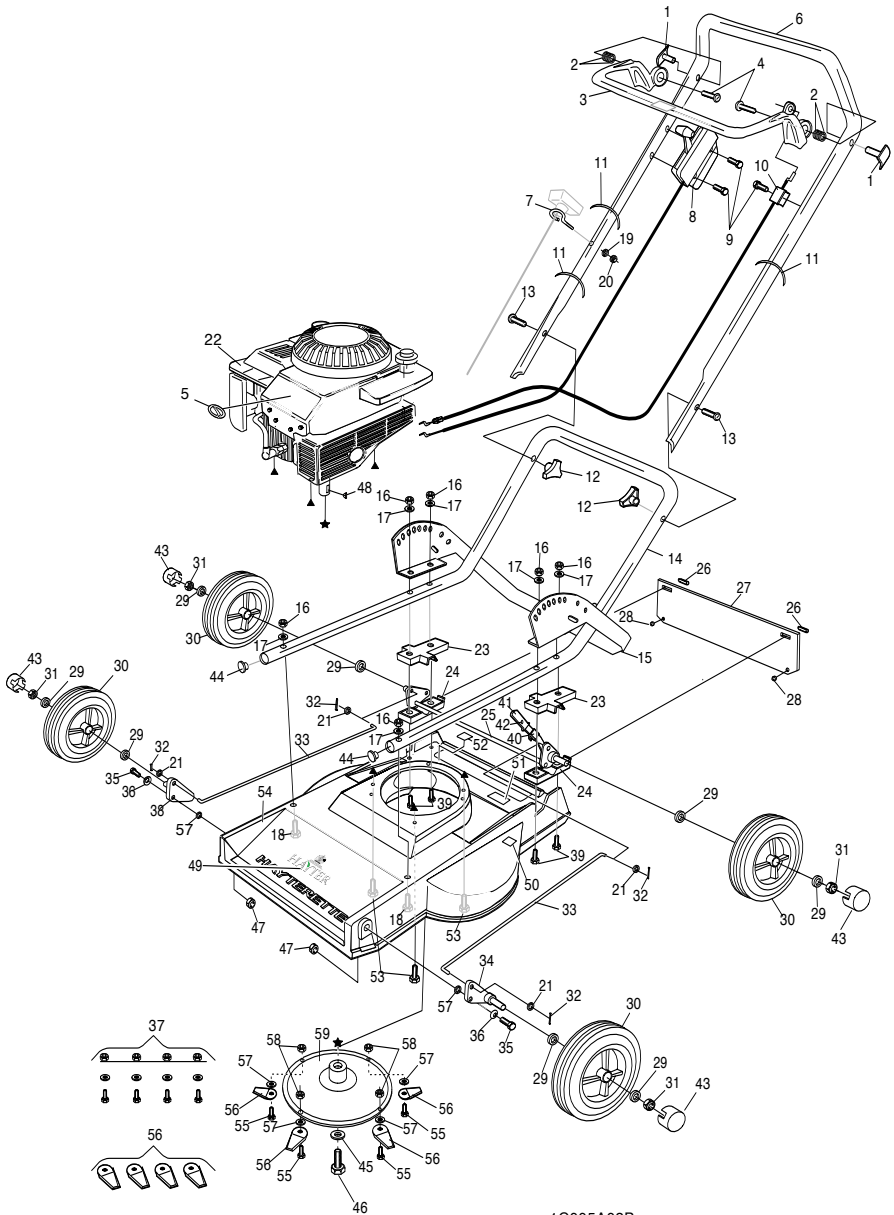

1C005A02B



**Notes:-**

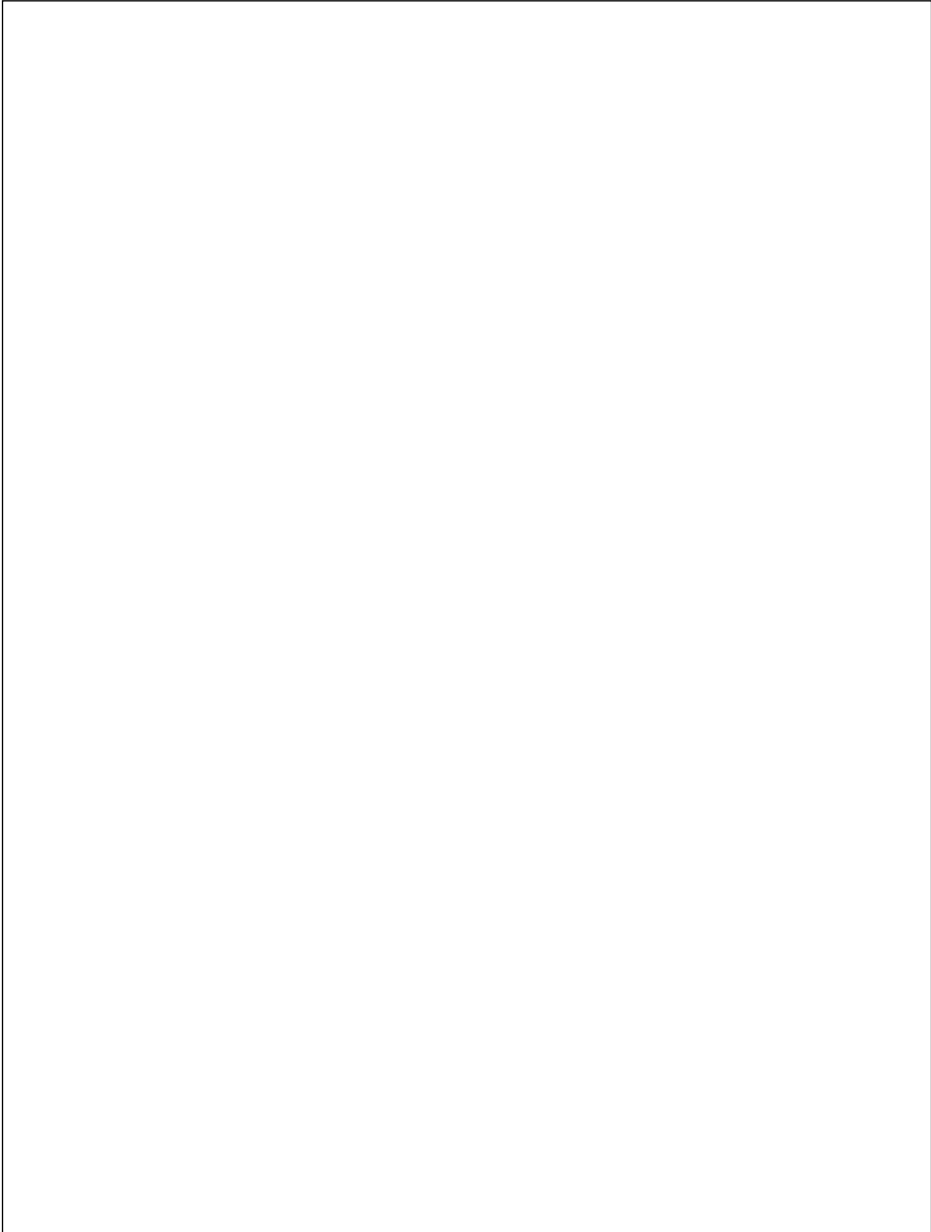

# NOTES

Notes:-



**Notes:-**

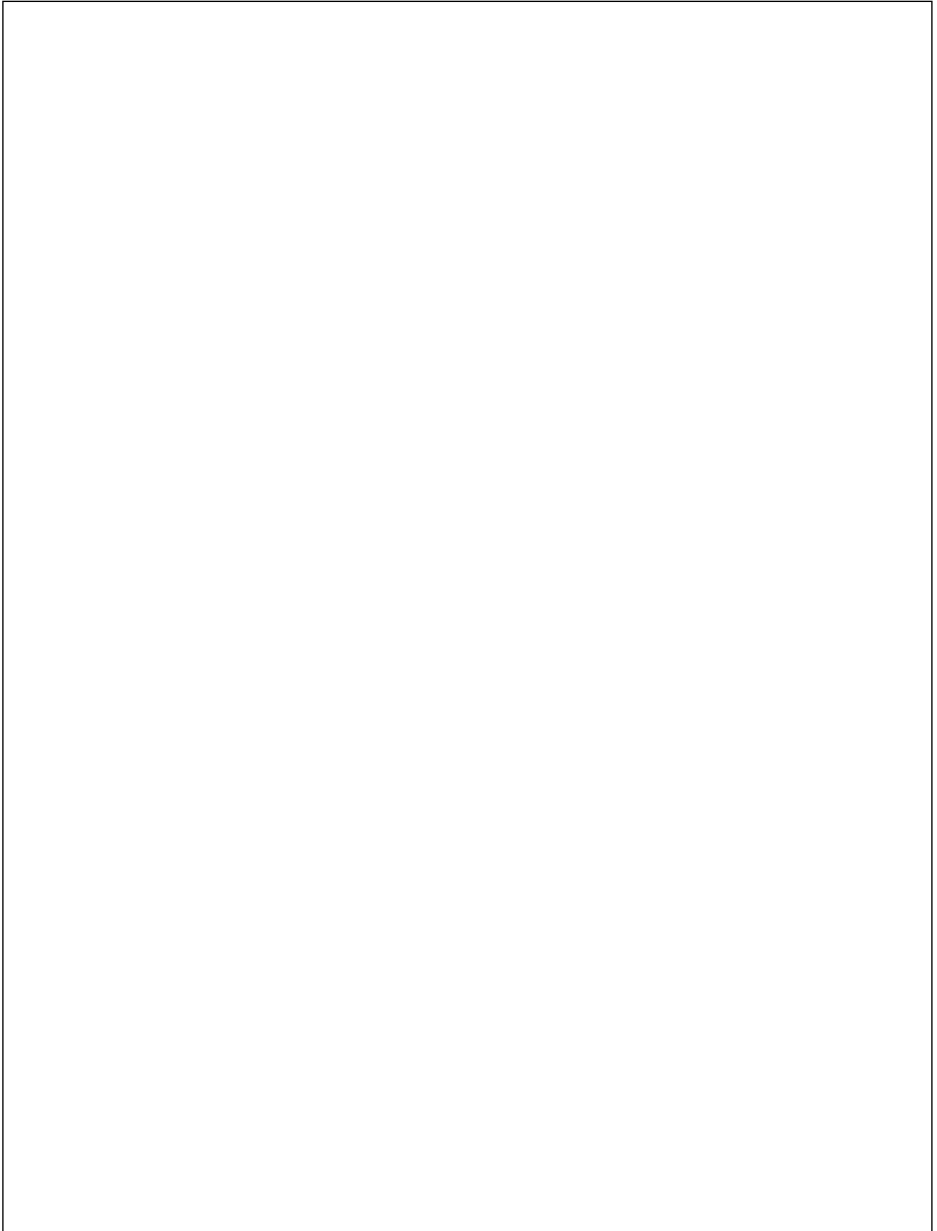

# CUSTOMER INFORMATION

Serial No:

Engine Type:- 12F802-1325-01    Engine:- Briggs & Stratton Quantum XTS 50

Date of Sale:- \_\_\_\_\_

Your Local Dealer:-

DEALER STAMP

## Free Manuals Download Website

<http://myh66.com>

<http://usermanuals.us>

<http://www.somanuals.com>

<http://www.4manuals.cc>

<http://www.manual-lib.com>

<http://www.404manual.com>

<http://www.luxmanual.com>

<http://aubethermostatmanual.com>

Golf course search by state

<http://golfingnear.com>

Email search by domain

<http://emailbydomain.com>

Auto manuals search

<http://auto.somanuals.com>

TV manuals search

<http://tv.somanuals.com>