

Ranger 53 Pro

CODE
396E

OWNER'S HANDBOOK

(English Version)

CODE SERIAL NO.

396E 270000001

Issue : 12.12.06

HANDBOOK: 111-1071 (Rev.A.)

Main Features

1. Spark Plug Lead.
2. Primer Bulb.
3. Engine Cover.
4. Air Filter.
5. Fuel Filler Cap.
6. Oil Filler Cap & Dipstick.
7. Height of Cut Lever.
8. Serial No. Label.
9. Rear Deflector.
10. Handlebar Securing Knob
11. Engine Start Grip.
12. Throttle Control.
13. Lever - Engine Stop.
14. Handlebar.
15. Ground Drive Clutch Lever.
16. Ground Drive Speed Control.
17. Grassbag Assembly.
18. Muffler Guard.

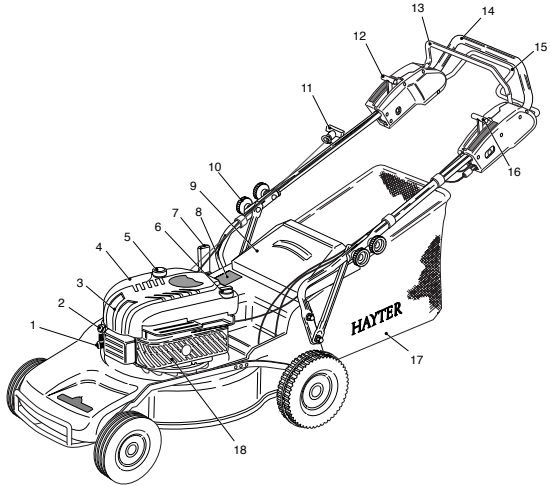

Specifications

MODELS	CODE 396 (SG56 RC VAR PRO)
Engine	Briggs & Stratton Intek Edge 60
Engine type	121602-0315-E1
Engine / cutterblade speed	2900 rpm
Fuel type	Unleaded petrol.
Fuel capacity	1.5 litres
Oil type	SAE 30 engine oil
Oil sump capacity	0.6 litres
Cutting width	530mm
Cutting height	25 - 85mm
Overall dimensions	1705 x 585 x 1025mm
Dry Weight	60.5 Kg
Spark Plug	NGK BCP5RES/CHAMPION RC12Y2
Spark Plug Gap	0.50mm

HAYTER

MAKERS OF THE FINEST MOWERS

1ST Year (12 months)

We certify that this service has been carried out by an Authorised Hayter Service Dealer

Date: _____

DEALER STAMP

HAYTER

MAKERS OF THE FINEST MOWERS

1ST Year (12 months)

Owner's Name: _____

Serial Number: _____

Date: _____

DEALER STAMP

Note for dealer: Please retain this voucher for your records.

HAYTER

MAKERS OF THE FINEST MOWERS

2nd Year (24 months)

We certify that this service has been carried out by an Authorised Hayter Service Dealer

Date: _____

DEALER STAMP

HAYTER

MAKERS OF THE FINEST MOWERS

2nd Year (24 months)

Owner's Name: _____

Serial Number: _____

Date: _____

DEALER STAMP

Note for dealer: Please retain this voucher for your records.

- 1.2 Main Features/Specifications**
- 1.5 Contents**
- 1.6 Introduction**
- 1.7 Warranty**
- 1.8 - 1.11 Safety Precautions**
 - 1.8 *Safety Alert Symbol*
 - 1.8 *Training*
 - 1.8 *Preparation*
 - 1.9 *Preparation*
 - 1.9 *Operation*
 - 1.10 *Operation*
 - 1.10 *Maintenance & Storage*
 - 1.11 *Maintenance & Storage*
 - 1.11 *Safety Symbols*
 - 1.11 *Control Symbols*
- 1.12 - 1.13 Assembling the Mower**
 - 1.12 - *Delivery Checklist*
 - 1.12 - *Handlebar*
 - 1.13 - *Grassbag Assembly*
 - 1.13 - *Grassbag Attachment*
- 1.14 Before Starting the Mower**
 - 1.14 - *Prevent Engine Damage*
 - 1.14 - *Oil Type*
 - 1.14 - *Check Oil Level*
 - 1.14 - *Fuel Type*
- 1.15 - 1.21 Operating The Mower**
 - 1.15 - *Controls*
 - 1.15 - *Starting*
 - 1.16 - *Forward Travel*
 - 1.16 - *Reverse Travel*
 - 1.17 - *Turning*
 - 1.17 - *Stopping*
 - 1.18 - *Slopes*
 - 1.18 - *Height of Cut*
 - 1.18 - *Before Mowing*
 - 1.18 - *Grassbag*
 - 1.19 - *Without Grass Collection*
 - 1.19 - *Heavy Growth*
 - 1.19 - *Friction Disc*
 - 1.19 - *Non-Grassed Areas*
- 1.20 - 1.21 *Lawn Care Calendar - Guide only*
- 1.22 Maintenance Schedule**
- 1.23 - 1.29 Mower Maintenance**
 - 1.23 - *Engine*
 - 1.23 - *Throttle Cable Adjustment*
 - 1.23 - *Carburettor Adjustments*
 - 1.24 - *Oil Service*
 - 1.24 - *Air Cleaner Service*
 - 1.25 - *Spark Plug Service*
 - 1.25 - *Keeping Engine Clean*
 - 1.25 - *Grassbag*
 - 1.26 - *Deck Housing*
 - 1.26 - *Securing Nuts and Bolts*
 - 1.26 - *Clutch Cable Adjustment*
 - 1.27 - *Lubrication*
 - 1.27 - *Cutterblade Removal*
 - 1.28 - *Cutterblade Assembly*
 - 1.28 - *Cutterblade Sharpening*
 - 1.29 - *Storage*
- 1.30 - 1.31 Trouble Shooting**
- 1.32 Declaration of Conformity**
- 1.33 - 1.36 Parts List**
- 1.37 Parts list Diagram**
- 1.38 Customer Info**
- 1.39 - 1.40 Notes**

INTRODUCTION

Thank you for purchasing a **Hayter** mower. The following pages are designed to help you gain safe and efficient service from your machine.

IMPORTANT: This 'Owners Handbook' should be regarded as part of the mower as it gives essential information regarding mower safety, operation, maintenance and specifications. Read and understand this handbook prior to operating your mower for the first time. Make sure you are familiar with all the controls and points of regular maintenance. If you have any doubts, consult your local **Hayter** authorised dealer who will be pleased to give you assistance.

IMPORTANT: This mower is designed solely for use in a domestic grass cutting environment. Use in any other way is considered as contrary to the intended use. Compliance with and strict adherence to the conditions of operation, service and repair as specified in this handbook also constitute essential elements of the intended use.

This mower should be operated, serviced and repaired only by persons who are familiar with its particular characteristics and who are acquainted with the relevant safety procedures.

The safety precautions listed in this handbook and all other generally recognised regulations on safety must be observed at all times.

Any arbitrary modifications carried out to this machine may relieve Hayter Limited of liability for any resulting damage or injury.

Hayter mowers are robustly constructed and designed for efficient economical performance under normal mowing conditions. Correct operation and maintenance will ensure a long and satisfactory service life. Prior to despatch from our factory every effort is made to ensure that your mower is delivered in perfect condition.

Throughout this handbook all references to **left** and **right** are as viewed from behind the handlebar, in the direction of forward travel.

This handbook is based on information available at the time of publication.

HAYTER LIMITED reserve the right to amend product specifications without prior notification.

LIMITED WARRANTY

Hayter Limited warrants to the original user/purchaser that this unit shall be free from defects in material and workmanship under normal use and service for a period of **one year** from the date of purchase. The manufacturers of the engine furnish their own warranty and services are provided through their authorised network (Refer to "Engine Warranty Statement"). To qualify for the full benefit of the warranty, the Warranty Registration Card must be returned to Hayter Limited within 14 days of purchase. If the selling dealer has not returned the Warranty Registration Card which is attached to the rear of the Owners Handbook please complete and return. Subject to the conditions and exclusions noted in this limited warranty, we shall at our option, repair or replace any warranted part during the applicable period. If you are in doubt or experience any difficulty, please consult a Hayter Authorised Service Dealer for clarification.

A 90 day warranty period applies to those items which are subject to normal wear and tear e.g. wheels, cutterbars, cables, grassbags and other consumable wearing parts.

All machines which are fitted with a **genuine** Hayter Friction Disc or Crankshaft Support Bearing as original equipment before use, are covered by a **Lifetime Warranty** against the engine crankshaft bending. **Note:** friction washers, Blade Brake Clutch (B.B.C.) units and other such devices are not applicable. Only machines fitted with a **genuine** Hayter friction disc or crankshaft support bearing, which are used in accordance with the recommended operating and maintenance procedures, are covered.

This warranty does not apply to any unit that has been tampered with, altered, misused, abused or used for hire, and will become invalid if non genuine Hayter parts are fitted. This warranty does not cover for minor mechanical adjustments unless they are due to defective material or workmanship. Consult the Owner's Handbook or a Hayter Authorised Service Dealer for assistance when making these adjustments.

To make a warranty claim, return the unit to a Hayter Authorised Service Dealer along with proof of purchase stating the machine serial number and date of purchase. Subject to the conditions and exclusions in this limited warranty, the authorised dealer will, at our option, repair or replace any warranted part within the duration of the warranty period.

This limited warranty gives you specific legal rights and is in addition to any statutory rights to which you may be entitled and your statutory rights are not affected by this warranty. If you need additional information concerning this written warranty, or assistance in obtaining services, please write to : **HAYTER LIMITED, Service Department, Spellbrook, Bishop's Stortford, Hertfordshire CM23 4BU**

UK ONLY: Details of your local **Hayter** authorised dealer are contained in Yellow Pages and the Hayter Website www.hayter.co.uk or contact:- Freephone 0800 616298.

SAFETY PRECAUTIONS

Safety Alert Symbol



This safety alert symbol indicates important safety messages. When you see this symbol be alert to the possibility of injury. Carefully read the following and inform others.

Your mower is perfectly safe if used correctly. Failure to observe the following precautions may result in serious injury.

Training



Before using the mower read the owners handbook carefully. Pay particular attention to the safety precautions. Ensure that you are familiar with the controls and the proper use of the equipment. Learn how to stop the mower quickly in an emergency.

Never allow children or people unfamiliar with these instructions to use the mower.

Never mow while people, especially children, or pets are nearby.

Keep in mind that the user is responsible for accidents or hazards occurring to other people or their property.

Preparation



While mowing, always wear substantial footwear and long trousers. Do not operate the equipment when barefoot or wearing sandals.

Thoroughly inspect the area where the mower is to be used and remove all objects which may be thrown by the machine.

WARNING: Petrol is highly flammable.

- Store fuel in containers specifically designed for this purpose.
- Add fuel before starting the engine. Never remove the cap from the fuel tank or add petrol while the engine is running or when the engine is hot. Allow the engine to cool for at least two minutes before refuelling.
- Do not attempt to start the engine if petrol is spilled or a smell of petrol is present. Move the mower away from the area of spillage and avoid creating any source of ignition until petrol vapours have dissipated.

SAFETY PRECAUTIONS

Preparation

- Always use fresh fuel. Stale fuel can block the carburettor and cause leakage.
- Replace fuel tank and oil tank caps securely.
- Replace faulty exhaust.

A damaged cutterblade or loose fixing bolt are major hazards. Before use, always visually inspect the cutting mechanism to ensure that it is in good condition. A damaged cutterblade must be replaced immediately with a genuine Hayter replacement part



Operation

Do not operate the engine in a confined space where exhaust fumes (carbon monoxide) can collect. Refuel outdoors only and do not smoke while refuelling.

Always pull the starter cord slowly until resistance is felt. Then pull the cord rapidly to avoid kickback and prevent hand or arm injury.

Mow only in daylight or good artificial light.

Avoid using the mower on wet grass, where feasible.

Always be sure of your footing on slopes.

Walk, never run.

Mow across the face of slopes, never up and down.

Exercise extreme caution when changing direction on slopes.

Do not mow excessively steep slopes of more than 20 degrees.

Use extreme caution when reversing or pulling the mower towards you.

Stop the engine before moving the mower across areas other than grass.

Never operate the mower unless the guards are securely in position and in good condition.

Do not change the engine governor settings or overspeed the engine.

Disengage the rear roller drive clutch before starting the engine.

Start the engine carefully, with feet well away from the cutterblade.

Variable speed control must only be operated whilst the engine is running



SAFETY PRECAUTIONS

Operation



Do not tilt the mower when starting the engine.

Do not put hands or feet near or under rotating parts.

Never pick up or carry the mower while the engine is running.

Never lift the rear deflector while the engine is running.

Never touch the exhaust/exhaust guard or cooling fins when the engine is hot.

Stop the engine and disconnect the spark plug lead:

- Before clearing blockages or unclogging the discharge chute.
- Before cleaning/checking or working on the mower.
- After striking a foreign object. Inspect the mower for damage and ensure necessary repairs are made before re-starting.
- If the mower starts to vibrate abnormally (check immediately).

Stop the engine:

- Whenever you leave the mower.
- Before refuelling.
- Reduce throttle control setting during engine shutdown.

Maintenance & Storage



Keep all nuts, bolts and screws tight to ensure that the equipment is in safe operating condition.

Frequently check fuel lines and fittings for cracks or leaks and replace if necessary.

Never check for a spark when the spark plug is removed. (Use approved tester)

Inspect the exhaust periodically and replace if worn or leaking.

Never crank the engine with the spark plug removed.

Never start the engine with the air-cleaner or air-cleaner cover removed.

Never store the mower with petrol in the tank within an enclosed area where fumes may reach an open flame or spark.

This machine contains spring loaded assemblies which could cause a hazard when dis-assembled and re-assembled, this maintenance should only be carried out by a Hayter authorised dealer.

SAFETY PRECAUTIONS

Maintenance & Storage

Allow the engine to cool before storing in any enclosure. To reduce the fire hazard, keep the engine and the surrounding deck area free of grass, leaves, or excessive grease.

Check the rear deflector and grassbag frequently for wear or deterioration. Replace worn or damaged parts for safety.

If the fuel tank has to be drained, this should be done outdoors and when the engine is cool.

Wear strong work gloves when removing and reassembling the cutterblade.

Always replace worn or faulty parts with genuine Hayter parts.



Safety Symbols

Safety Alert - Be aware to the possibility of injury.



Danger of severing toes or fingers in cutting mechanism.

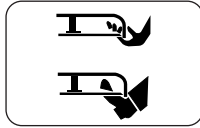

Danger of being hit by thrown objects.



Carefully read the Owners Handbook before using the machine.

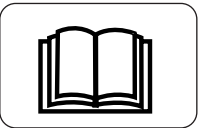

Stop engine and remove spark plug lead before working on the mower.

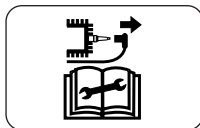

Keep bystanders at a safe distance from the mower.

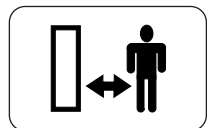

Control Symbols

Engine Stop
(Symbol)

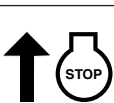

Height of Cut Adjustment
(Symbol)

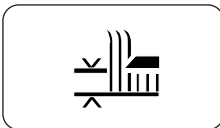

Throttle Control
(Symbols)

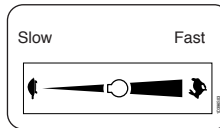

Variator Control
(Symbols)

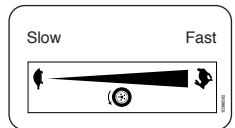

ASSEMBLING THE MOWER

Delivery Checklist

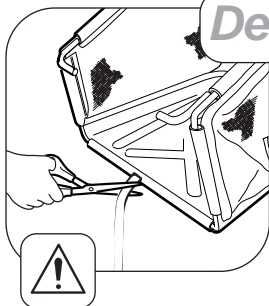

Remove the mower from the packaging and check that the following items have been supplied correctly. If any items are missing contact your local Hayter dealer.

Description	Quantity	Description	Quantity
Handlebar Lower LH	1	Large Knob	4
Handlebar Lower RH	1	Upper Handlebar	1
Coach Bolt	4	Cap	4
Washer	4	Cable Guide	4
Nut	4	Grassbag Frame	1
Handlebar Support LH	1	Grassbag Fabric	1
Handlebar Support RH	1	Grassbag Flap	1
		Engine Handbook	1

To prevent accidents cut off the long ribbon attached to the grassbag and discard.

Assembling the Mower for the first time

Handlebar

Assemble the handlebars: Assemble the handlebars as shown. Route the cables carefully and clip in position to avoid damage and entanglement when using the machine.

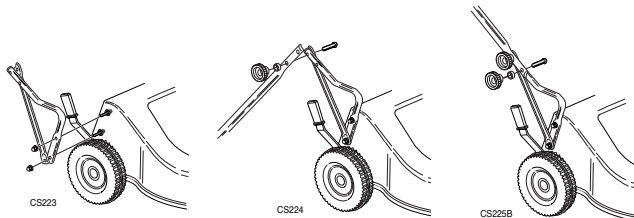

CAUTION - PREVENT DAMAGE : When assembling the handlebar, take care to ensure that the controls and cables do not become damaged. Always replace damaged controls and cables before using the mower.

ASSEMBLING THE MOWER

Assembling the Mower for the first time

Grassbag Assembly

Assemble the grassbag: Insert metal frame into grassbag fabric and clip into position. Push grassbag flap onto frame to fix in position.

WARNING - PREVENT ACCIDENTS: Always ensure grassbag flap is securely fitted and in good condition.

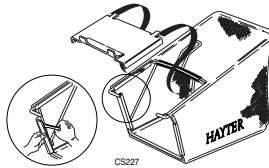
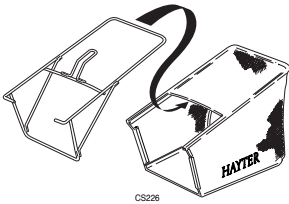

Grassbag Attachment

Raise the rear deflector, lower the grassbag through the handlebar and hook in position. Lower the deflector to rest on the grassbag.

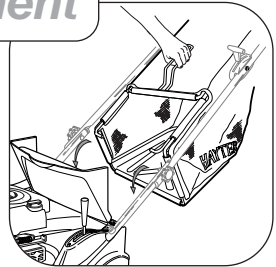

BEFORE STARTING THE MOWER

Prevent Engine Damage



To prevent engine damage the engine is shipped without oil or petrol. The engine must be filled with the correct grade of oil and petrol before starting the engine.

Oil Type

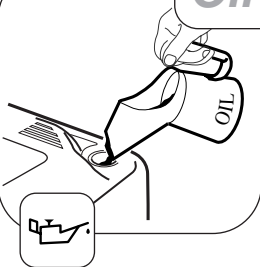

Always use high quality detergent oil classified SAE 30 oil. Never use additives with recommended oil.

To prolong the life of your engine it is important that the oil is changed after the first 5 hours of use - refer to 'Maintenance Schedule'.

Check Oil Level

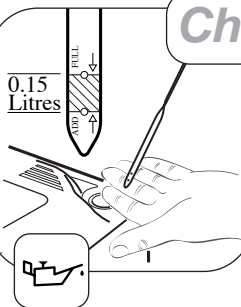

Clean around the oil filler cap before removing. With the mower on a level surface, unscrew and remove the oil filler - dipstick. Wipe oil from it with a clean cloth. Screw the oil filler - dipstick back in place, then unscrew and remove it to check the oil level.

The oil level is correct when it is at the **full** mark on the dipstick.
DO NOT OVERFILL.

Fuel Type

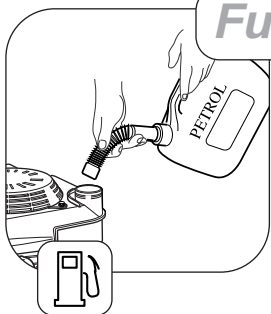

Always use clean, fresh unleaded petrol. Purchase fuel in quantities that can be used within 30 days. Never mix oil with petrol. For added engine protection Briggs & Stratton recommend the use of their fuel additive which is available from an authorised Briggs & Stratton service dealer.

Fill to base of neck to allow for fuel expansion. Do not overfill the fuel tank.

OPERATING THE MOWER

Controls

Operate all control levers several times and ensure that the cables move freely. Check that the engine stop and ground drive clutch levers return freely to their rest position when released.

Whilst operating the engine throttle mechanism slight resistance should be felt when moving the lever to the 'choke' position.

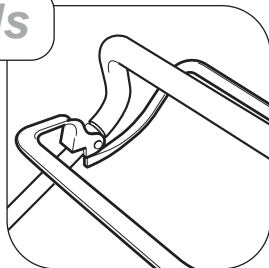

Starting - Step 1

Operate the primer bulb: Push on the primer bulb 5 times at two second intervals to provide the extra fuel to start the engine after assembling the mower for the first time.

In normal use, push on the primer bulb 3 times at two second intervals to provide the extra fuel required to start a cold engine. Operation of the primer bulb is usually unnecessary when starting a warm engine.

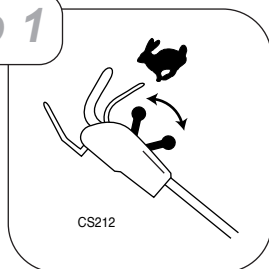

Step 2

Stand behind the mower and hold the handlebar together with the engine stop lever with your left hand. With your right hand hold the engine start - grip and pull slowly until resistance is felt, then pull rapidly to crank the engine, carefully return the start grip to the storage position when the engine starts.

If the engine does not start after 5 attempts - refer to "Trouble Shooting".

The engine stop lever must be held firmly against the handlebar to start and keep the engine running. If the engine stop lever is released the engine will stop.

To prevent damage never pull the engine start grip when the engine is running.

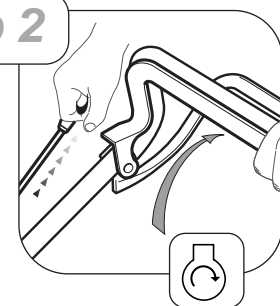

OPERATING THE MOWER

Forward Travel

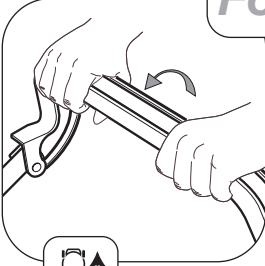

Hold the handlebar and operate the ground drive clutch lever to power the mower in a forward direction.

When the ground drive clutch lever is disengaged the mower may be pushed. This feature is useful when mowing in confined areas.

Ground speed may be adjusted by operating the speed variator control. Push forward to slow down and pull back to speed up

IMPORTANT To avoid damage this control should only be operated whilst the engine is running. If the engine stop lever is released the engine will stop.

Reverse Travel

Hold and pull against the handlebar with both hands to reverse the mower.

OPERATING THE MOWER

Turning

To make a wide turn steer the mower with the handlebar in the direction required.

To make a tight turn release the ground drive clutch lever, apply downward pressure on the handlebar to raise the front wheels just above ground level and steer in the required direction.

To prevent accidents do not raise the front of the mower excessively when making a turn. Never raise the rear of the mower when the engine is running.



Stopping

Reduce the throttle setting and then release the ground drive clutch lever followed by the engine stop lever.

Emergency stop: Release both ground drive clutch lever and engine stop lever together.

If the engine fails to stop, move the throttle lever to the 'slow' position and disconnect the spark plug lead.

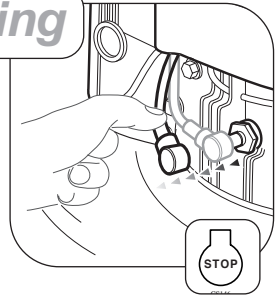

OPERATING THE MOWER

Slopes

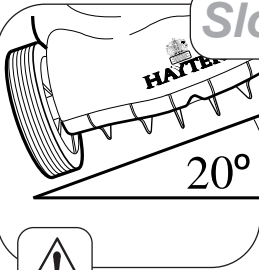

To prevent engine damage do not use the mower on slopes greater than 20 degrees.

Height of Cut

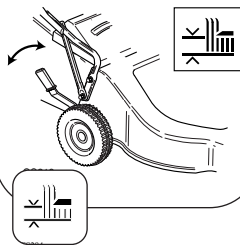

Move the height of cut lever sideways to disengage it from the locking notch, then push forwards to lower or pull backwards to raise the height of cut. Release the lever in the required position and ensure that it locks firmly into one of the seven notch settings.

Always select a height of cut to suit operating conditions. Prevent engine overloading and blockages by avoiding low cuts in long grass conditions. Be prepared to make two cuts when the grass is long.

Before Mowing



To prevent accidents thoroughly inspect the area and remove all objects which when contacted by the mower cutterblade could become dangerous projectiles. Inspect the area for hidden obstructions which when contacted by the cutterblade could risk health and safety or result in damage to the mower. Remember the location of these obstructions and ensure that you mow around them.

Grassbag

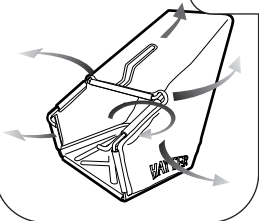

Raise the rear deflector and lift the grassbag through the handlebar and lower the rear deflector to rest against the rear of the mower.

To empty the grassbag, pour out the grass clippings and shake the grassbag vigorously to clean the airways. Good grass collection depends on good air flow through the grassbag. When collecting grass clippings it is important that the grassbag is emptied regularly to prevent blockages and engine overloading.

OPERATING THE MOWER

Without Grass Collection

Remove the grassbag and operate the mower with the rear deflector in the closed position.

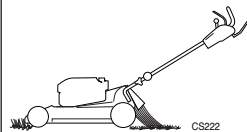

Heavy Growth

Areas of heavy growth should be mown without collecting the clippings. If collection is required, first mow the area without the grassbag at the maximum height of cut setting. Allow the grass clippings to dry out and then mow the area at the maximum height of cut setting with the grassbag fitted. Reduce the height of cut and mow the area again as necessary until the required finish is obtained.

To prevent damage to your lawn do not remove more than one third of grass height in one cut.

Friction Disc

The cutterblade is driven by the engine via a friction disc to help prevent damage occurring to the engine crankshaft and cutting mechanism when a hidden obstruction or overload is encountered.

Always stop the engine when a hidden obstruction or excessive vibration is encountered. Disconnect the spark plug lead and examine the cutting mechanism. ALWAYS replace a damaged cutterblade - refer to "Maintenance".

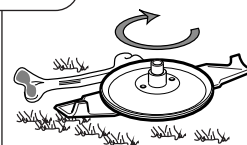

Non-Grassed Areas

When moving the mower across non-grassed areas, stop the engine and set the mower to the maximum height of cut to protect the cutting mechanism.

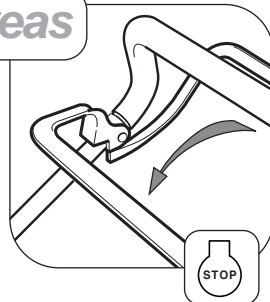

LAWN CARE CALENDAR

To be used as a guide only.

January

There is very little work to do this month apart from brushing away leaves. Keep off the grass if frozen or waterlogged.

February

Rake the grass thoroughly. Spike the lawn to aerate and stimulate soil organisms and root growth and apply lawn sand if necessary.

March

The yearly lawn work programme really starts this month. As soon as the ground conditions are suitable, the first cut can be made. The first cut should merely “top” the grass as close cutting at this stage could result in severe yellowing or browning. Two cuts are generally sufficient this month.

April

Mow often enough to stop grass growing away. Dig out patches of coarse grass or resistant weed. Re-seed bare patches.

May

Keep mowing increasing the frequency as required. Treat with selective weed killers or combined weed/feed preparations if you did not feed the lawn in April.

June

Summer mowing should now be under way. It should be necessary to mow the lawn twice a week. Raking before mowing is important this month as the combined action keeps runners of clover under control. Water the grass if necessary, and remember to soak thoroughly.

July

Treat the grass with the second application of fertiliser or weed killer/fertiliser. Water when necessary and rake occasionally. As a general rule the grass clippings should be removed each time you mow. If weather conditions are dry and hot and the grass is weed free, leave the clippings on the lawn to help maintain ground moisture.

LAWN CARE CALENDAR

August

Keep mowing regularly and watering as necessary. Fill any cracks caused by drought with a mixture of sharp sand and soil. In dry weather conditions leave the grass longer to help retain ground moisture.

September

Raise the height of cut to allow the grass to thicken and protect the roots from the winter frost and snow.

October

Rake out the thatch from the turf and spike the lawn to assist in drainage. Brush in peat and sharp sand.

November

Use a stiff broom to disperse worm casts before mowing. Keep turf free from leaves.

December

Apart from brushing away leaves, December is a slack end of a busy year. Keep off the lawn if it is very wet or frozen.

MAINTENANCE SCHEDULE



To prevent accidents stop the engine and disconnect the spark plug lead before attempting to carry out maintenance procedures on the mower.

- After the very first hour check clutch adjustment.
- After the very first five hours change the engine oil.

Follow the hourly or calendar intervals, whichever occurs first. More frequent service will be required if working for prolonged periods under dusty, dry conditions, or when airborne debris is present or after extensive operation cutting tall, dry grass.

Daily

- Check the oil level
- Remove grass debris from around the engine, exhaust/exhaust guard, air ways in the top cowl and underside of the deck housing.
- Remove grass debris from the grassbag and check for signs of damage.
- Check the condition of guards and safety devices and cutterblades.

25Hrs or Every Season

- Change the engine oil if continuously operating under heavy load or high ambient temperature.
- Service the air cleaner.
- Lubricate wheels, pivot points and linkages and grease the inner control cables at point of entry and exit from their outer casing.
- Check the clutch cable adjustment.
- Sharpen the cutterblade.

50Hrs or Every Season

- Change the engine oil.

MOWER MAINTENANCE

100Hrs or Every Season

- Clean the engine cooling system. Clean more often under dusty conditions or when airborne debris is present or after prolonged operation whilst cutting tall, dry grass.
- Replace the spark plug.

Engine

1. Air Cleaner
2. Spark Plug / Lead
3. Carburetor
4. Exhaust Guard
5. Exhaust
6. Oil fill/Dipstick
7. Start Grip
8. Fuel Cap
9. Cover

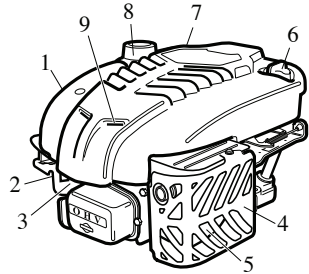

Throttle Cable Adjustment

Loosen casing clamp screw (1) and move the governor lever (2) in the direction of screw (1) as far as possible. Move the throttle control to the choke position. Tighten casing clamp screw.

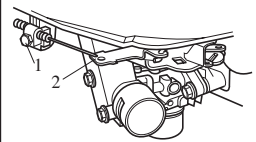

Carburettor Adjustments

Should only be made by an authorised Briggs & Stratton dealer. Under no circumstances should the engine be adjusted to run at a speed in excess of that shown on the Declaration of Conformity.

MOWER MAINTENANCE

Oil Service

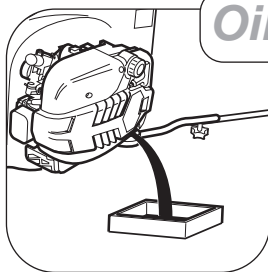

Check the oil level daily before starting the engine and ensure that the correct oil level is maintained. Refer to 'Before Starting the Mower' for oil checking and filling instructions.

Change the engine oil after the first 5 hours of operation and thereafter according to the 'Maintenance Schedule':-

1. Drain fuel by running the engine until the fuel tank is empty.
 2. Remove the spark plug lead.
 3. Allow the engine to cool.
 4. Drain the oil while the engine is warm.(Not hot)
-
5. Tip the mower over on to its left hand side thus ensuring that the air cleaner is kept uppermost **to prevent engine damage.**
 6. Remove the oil filler dipstick and drain the oil into a suitable container.
 7. Refill with new oil of the recommended SAE viscosity grade.
(Refer to-'Before Starting the Mower')

Air Cleaner Service

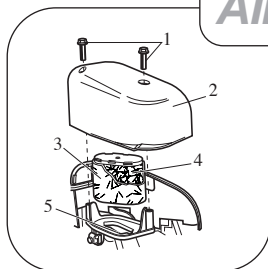

To service the air cleaner, loosen the two screws (1) and remove cover (2). Carefully remove pre-cleaner (3) and cartridge (4) wash in a solution of liquid detergent and water. Allow to air dry thoroughly before fitting.

If very dirty, replace.

- Do not use petroleum solvents.
- Do not use pressurised air.
- Do not oil the cartridge.

After servicing, install the pre-cleaner and cartridge in the assembly base (5). Replace the cover and securely tighten the screw to the base.

MOWER MAINTENANCE

Spark Plug Service

Use only Briggs & Stratton spark tester (1) to check for a spark as shown in the diagram.

Replace the spark plug every 100 hours or every season, whichever occurs first. A spark plug wrench is available from any authorised Briggs & Stratton service dealer.

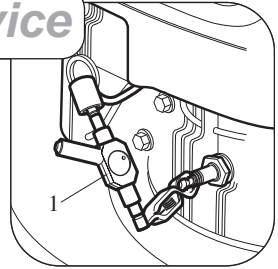

Check the spark plug gap with a feeler gauge and set at 0.50mm.

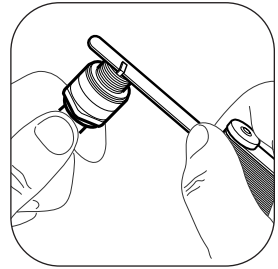

Keeping Engine Clean

Remove all grass and debris from the engine including the exhaust/exhaust guard, the air ways in the top cowl and the surrounding deck areas on a daily basis after use. Never spray the engine with water during cleaning. Water can contaminate the fuel. Always clean with a brush or compressed air.

Grass and debris may clog the engine's air cooling system especially after prolonged operation while cutting tall, dry grass. The internal cooling fins and surfaces may require cleaning to prevent overheating and engine damage. We recommend that this service be carried out by an authorised Briggs and Stratton dealer.

Grassbag

Remove grass debris from the grassbag immediately after use and check its condition for signs of damage.

To prevent accidents replace a damaged grassbag immediately.



MOWER MAINTENANCE

Deck Housing

Remove grass debris from the top and underside of the deck housing immediately after use.

Fertilisers and top dressings are particularly corrosive. Thoroughly clean the mower deck immediately after use on treated grass and store well away from corrosive materials.

Securing Nuts & Bolts



Regularly check that all securing nuts and bolts are tight. Replace missing or damaged items immediately.

Clutch Cable Adjustment

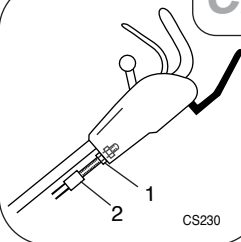

Check the clutch cable operation every 25 operating hours and adjust if necessary.

Unscrew locknut (1) and screw adjuster (2) in or out as necessary. Tighten locknut when correctly adjusted.

IMPORTANT - PREVENT DAMAGE: ALWAYS operate the mower with the clutch cable correctly adjusted. ALWAYS replace damaged cables.

Lubrication

Lubricate the wheels, pivot points and linkages with engine oil every 25 operating hours.

Apply a good quality medium grease to the inner control cables at the point of entry and exit from their outer casing.

Cutterblade Removal

Drain the fuel by running the engine until the fuel tank is empty and the engine stops. **Remove the spark plug lead** and allow the engine to cool. Turn the mower on its left hand side and ensure that the air cleaner side of the engine is uppermost.

Firmly grip the end of the cutterblade with the gloved hand and remove the bolt, spring washer and distance piece securing the cutterblade with a 8mm Hexagon Key.

To prevent accidents never work on the cutterblade unless the spark plug lead has been removed. The cutterblade has sharp edges. ALWAYS wear strong gloves to protect your hands when working on the cutterblade. DO NOT rotate tools towards the cutting edges to avoid the risk of injury should the tool slip. ALWAYS use genuine Hayter replacement parts.

The condition of the cutterblade and its mounting arrangement should be checked regularly for signs of wear or damage. Ensure that the cutterblade is not bent or cracked.

A damaged cutterblade that is out of balance will vibrate excessively and may break. **DO NOT** use an unbalanced cutterblade.

Regularly check that the bolt securing the cutterblade is tightened to the specified torque of 40Nm.

Replace the cutterblade every 2 years or sooner if excessively worn or damaged.

To prevent injury it is wise to seek assistance when turning the mower on its side.

MOWER MAINTENANCE

Cutterblade Assembly

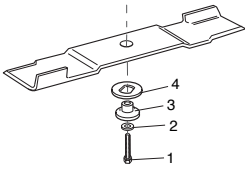

CS281 LH

Assemble the cutterblade with the turned up edges facing towards the engine. Secure the cutterblade using the bolt (1), spring washer (2), location spacer (3), large washer (4) and tighten to a torque of 40Nm.

Cutterblade Sharpening

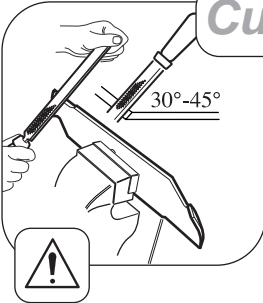

A slightly worn cutterblade may be re-sharpened. Both blade edges must be sharpened equally to ensure balance. Sharpen the cutterblade every 25 mowing hours or more frequently if conditions require. Remove the cutterblade from the mower and clean using a brush and water. Inspect the cutterblade for signs of damage. Sharpen both cutting edges with a flat file to restore performance.

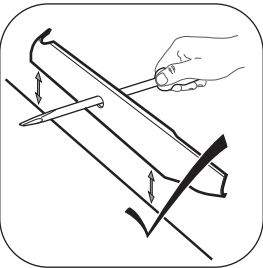

Ensure that the cutterblade is balanced. Use a screw driver with a round shaft to support the cutterblade through its centre hole. Hold the cutterblade horizontal and then release. A balanced cutterblade will remain horizontal.

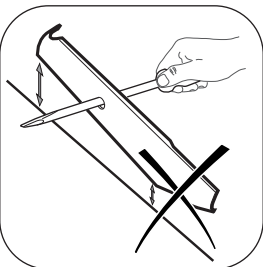

If the cutterblade is not balanced the heavy end will rotate downwards. Sharpen the heavy end until the cutterblade is correctly balanced.

Storage

To store the handlebar unscrew the securing knobs sufficiently to allow it to be pivoted forwards to rest against the mower. Take care to ensure that the control cables do not become snagged at the pivot point and depress the engine stop lever to prevent it being damaged through contact with the engine spark plug.

Engines stored in excess of 30 days need to be protected with Briggs & Stratton fuel additive or drained of fuel to prevent gum from forming in the fuel system or on essential carburettor parts. To ensure your mower is maintained in good working order it is important that the following procedure is adopted. Refer to the Maintenance section as necessary.

Drain fuel from the engine by operating the engine until it stops.

Disconnect the spark plug lead.

Change the engine oil.

Remove the engine spark plug and pour 15ml of engine oil into the engine cylinder and replace the spark plug. Do not exceed the stated volume of oil as engine damage may occur on re-starting. **Do not replace the spark plug lead.** Slowly pull the engine start - grip once to crank the engine. This will distribute the oil and help prevent engine corrosion.

Clean grass and debris from the engine cylinder, cylinder head cooling fins, under top cowl, and around and behind exhaust/exhaust guard.

Clean all other areas of the mower and ensure that the grassbag is clean.

Lubricate the mower.

Treat metal parts with a water repellent anti-corrosion product.

Cover the mower with a protective sheet and store it in a dry, ventilated area.

TROUBLE SHOOTING

PROBLEM	POSSIBLE FAULT	REMEDY
Engine will not turn over	Engine stop lever released. Incorrect oil level. Obstruction under deck.	Operate engine stop lever. Check oil level. Remove obstruction.
Engine smokes	Excess oil level. Air cleaner cartridge oil soaked or blocked.	Check oil level. Service air cleaner.
Engine runs then stops	Fuel starvation. Fuel cap vent blocked.	Fill fuel tank. Clean fuel cap vent.
Engine will not start	Engine under load. Fuel starvation. Engine cold. Incorrect/contaminated fuel. Spark plug lead disconnected. Throttle setting incorrect. Engine brake not released. Faulty spark plug.	Raise height of cut. Fill fuel tank. Set throttle to 'choke' position. Drain fuel tank and fill with correct fuel. Connect spark plug lead. Set throttle to 'fast' position. Operate engine brake lever. Clean and adjust gap or replace.
Engine runs rough	Spark plug lead becoming disconnected in use. Faulty spark plug. Air cleaner blocked. Incorrect/contaminated fuel.	Connect spark plug lead. Clean and adjust gap or replace. Service air cleaner. Drain tank and fill with correct fuel.

TROUBLE SHOOTING

PROBLEM	POSSIBLE FAULT	REMEDY
Engine vibrates excessively	Mounting bolts loose. Cutterblade bolt loose. Cutterblade out of balance. Bent crankshaft.	Tighten bolts Tighten bolt Balance cutterblade Consult your dealer
Uneven cut	Undulating ground conditions Cutterblade worn Cutterblade out of balance Wheels / roller damaged	Change direction of travel Sharpen the cutterblade Balance the cutterblade Inspect and replace as necessary
Discharge chute blocks	Grass is wet Cut height too low Grassbag full Airflow through the grassbag is restricted Engine speed too slow	Mow dry grass Increase cut height Empty grassbag Clean the grassbag Set throttle to fast position
Mower is hard to push	Cut height too low Wheels / roller damaged	Increase cut height Inspect and replace as necessary
Mower will not self propel (Autodrive Only)	Clutch out of adjustment Drive belt damaged	Adjust clutch cable Replace drive belt
Poor grass collection	Airflow through the grassbag is restricted Discharge chute blocked Wet grass Grassbag full Engine speed too slow	Clean the grassbag Remove blockage Mow dry grass Empty grassbag Set throttle to fast position

DECLARATION OF CONFORMITY

EC DECLARATION OF CONFORMITY



Manufacturer: SANDRIGARDEN
Address: via Manzoni 22 36027 Rosa, Italia.

declare that the lawnmower:

Model name:	Ranger 53 Pro (SG56 RC VAR PRO)
Type:	Pedestrian Rotary
Model No:	CODE 396E
Cutting width:	52 cm
Speed of rotation of the cutting device:	2900 rpm
Width of the cutting device:	520mm
Engine manufacturer:	Briggs & Stratton
Speed of rotation of engine:	2900 rpm

Complies with the provisions of Directive: 98/37/EC Essential Health & Safety Requirements Relating to the Design & Construction of Machinery and Safety Components, as amended and the regulations transposed into national law.

Also Directive 89/336/EEC Electromagnetic Compatibility, as amended and the regulations transposed into national law.

Also Directive 2000/14/EC Noise emission in the environment by equipment for use outdoors and the regulations transposed into national law.

Procedure applied for the conformity assessment: ANNEX VI.

Notified Body: NOVICOM SAS DI R. CASTELLI & CO. Via della Fontana 23804 Monte Marenzo (LC)

Notified body identification No: 0723

Measured sound power level:	97 dB(A)
Sound pressure at the operator ear:	87 dB(A)
Guaranteed sound power level:	98 dB(A)
Complies with harmonized standards:	EN 292, EN 836 and EN ISO 14982

Signed

22-10-2006
SANDRIGARDEN srl
Managing Director

Declaration done and technical documentation kept at
SANDRIGARDEN,
via Manzoni 22,
36027 Rosa, Italia.

VIBRATION INFORMATION

The vibration level at the operator contact positions, measured in accordance with European Standard EN 836

CODE 396E (SG56 RC VAR PRO) = 4.6ms^{-2}

PARTS LIST

ITEM NO.	DESCRIPTION	PART NO.	QTY.	ITEM NOTE
1	Belt - Variable Pulley to Gearbox	SA284930	1	
2	Belt - Engine Crankshaft to Variable Pulley	SA284920	1	
3	Pulley - Variable	SA362860	1	
4	Washer - Plain	SA2014040	2	
5	Bracket - Pivot	SA380200	1	
6	Spacer - Rear Wheel	SA2011120	2	
7	Nut - M8	SA1013910	1	
8	Plate - Gearbox	SA395620	1	
9	Circlip	SA142180	1	
10	Bolt - Carriage	SA101810	1	
11	Rod - Rear Deflector			(see item 121)
12	Washer - Locating	SA280480	1	
13	Setscrew	SA165110	1	
14	Clamp - Cable	SA347810	1	
15	Cable - Variable Speed	SA2013540	1	
16	Cover - Variable Pulley	SA480190	1	
17	Spring - Rear Deflector		1	(see item 121)
18	Bearing	SA203560	10	
19	Decal - Height of Cut	320006	1	
20	Gear - Rear Wheel	SA496770	2	
21	Cover - Wheel	SA380570	2	
22	Washer - Plain	SA150770	4	
23	Deck	SA380390	1	
24	Key	SA101370	1	
25	Boss - Pulley	SA2051520	1	
26	Washer - Bellville	SA2006400	2	
27	Washer - Large	SA3006420	2	
28	Screw - M12 x 75	SA1013980	2	
29	Blade	SA2049630	1	
30	Spacer - Location	SA3006410	1	
31	Washer - Spring	SA281100	1	
32	Screw - Blade	SA281080	1	
33	Setscrew - Hex. Hd.	SA152010	4	
34	Rim - Wheel	SA396610	2	
35	Serial No. Label		1	
36	Decal - Engine	396002	1	
37	Engine	—		
38	Nut - Full	SA1013920	4	
39	Plate - Clamp	SA344110	2	
40	Screw - Self Tapping	SA180980	12	

PARTS LIST

ITEM NO.	DESCRIPTION	PART NO.	QTY.	ITEM NOTE
41	Axle - Front	SA3037790	1	
42	Bush - Axle	SA480180	2	
43	Washer - Plain	SA144370	1	
44	Wheel - Rear	SA385160	2	
45	Decal - Hayter	410087	1	
46	Bush	SA2037910	2	
47	Knob - Large	SA2008490	4	
48	Cap	SA340060	4	
49	Nut	SA194020	4	
50	Handlebar - Lower R.H.	SA380600	1	
51	Nut - Full Flanged	SA194010	7	
52	Mounting Ring - Engine	SA396640	1	
53	Handlebar - Upper	SA380420	1	
54	Bolt - Carriage	SA101740	4	
55	Loop - Recoil Rope	SA295640	1	
56	Support R.H. - Handlebar	SA380590	1	
57	Screw - Hex Hd. - Self Tapping	SA172850	2	
58	Washer - Plain	SA181690	2	
59	Bolt	SA172960	1	
60	Bolt	SA184540	1	
61	Cap - Hub	SA380740	4	
62	Bolt - Special	SA3021890	2	
63	Washer - Fixing	SA145900	4	
64	Handlebar - Lower L.H.	SA380290	1	
65	Support L.H. - Handlebar	SA380300	1	
66	Flap - Grassbag	SA480400	1	
67	Spring - Compensating	SA280160	1	
68	Screw	SA1015560	3	
69	Rod - Connecting	SA3037780	1	
70	Strip - Protection	SA380970	1	
71	Screw - Self Tapping	SA1012790	8	
72	Throw Plate	SA380470	1	
73	Nut - Flanged	SA142260	2	
74	Lever - Height of Cut	SA480140	1	
75	Spring - Torsion	SA280450	1	
76	Pin - Roll	SA180460	1	
77	Key - Drive	SA203510	2	
78	Circlip	SA144590	4	
79	Collar	SA403510	2	
80	Spacer - Plastic	SA403520	2	

PARTS LIST

ITEM NO.	DESCRIPTION	PART NO.	QTY.	ITEM NOTE
81	Gear	SA242210	1	
82	Washer - Plastic	SA403540	2	
83	Nut	SA144450	2	
84	Axle - Rear	SA3037810	1	
85	Plate - Clamp	SA280550	2	
86	Cap Screw - Soc Hd. C'Sunk	SA193610	2	
87	Damper - Rear Deflector	SA403190	2	
88	Lever - Engine Stop	SA380560	1	
89	Handle - Rear Deflector	SA406070	1	
90	Lever	SA443670	2	
91	Bolt	SA147780	2	
92	Washer - Lever	SA480710	2	
93	Washer - Plain	SA144480	2	
94	Gear	SA242220	1	
95	Spacer	SA284100	4	
96	Pin - Pivot	SA180790	2	
97	Screw	SA140310	6	
98	Nut - Nyloc	SA140270	14	
99	Plate - Blanking	SA380690	1	
100	Cover	SA480660	1	
101	Cover	SA480840	1	
102	Screw - Self Tapping	SA185610	6	
103	Screw - Self Tapping	SA185620	4	
104	Cover	SA480820	1	
105	Wheel - Front	SA3012050	2	
106	Spacer - Ground Drive Cable	SA460260	1	
107	Spring - Ground Drive Cable	SA262090	1	
108	Cable - Ground Drive	SA2013880	1	
109	Cable - Engine Stop	SA2011320	1	
110	Cover	SA480640	1	
111	Gearbox	SA280230	1	
112	Spring - Tension	SA295930	1	
113	Pin - Roll	SA280890	1	
114	Pulley	SA284840	1	
115	Screw - Self Tapping	SA184940	8	
116	Bolt - Engine	SA145670	2	
117	Bolt - Engine	SA145680	1	
118	Frame - Grassbag	SA380380	1	
119	Lever - Ground Drive	SA380430	1	
120	Cable - Throttle	SA285900	1	

PARTS LIST

ITEM NO.	DESCRIPTION	PART NO.	QTY.	ITEM NOTE
121	Deflector - Rear (includes items 11 & 17)	SA380830	1	
122	Setscrew	SA142760	2	
123	Washer	SA147740	2	
124	Guide - Cable	SA446340	3	
125	Plug	SA251950	2	
126	Decal - Throttle	SA647880	1	
127	Decal	SA689200	1	
128	Bush - Crankshaft Support	SA280820	1	
129	Decal - Variable Speed	SA689190	1	
130	Support - Crankshaft (Includes Item 128)	SA394080	1	
131	Decal - Warning	111-0083	1	
132	Shim	SA145250	4	
133	Washer - Wavy	SA245240	4	
134	Screw - Self Tapping	SA172850	9	
135	Skirt - Steel	SA380910	1	
136	Skirt - Side	SA380900	2	
137	Fabric - Grassbag	SA289560	1	
138	Bumper - Bar	SA3016080	1	
139	Ring - Locating	SA396620	2	
140	Screw - Self Tapping	SA184950	28	
141	Screw	SA145700	2	
142	Screw	SA142450	2	
143	Nut - Full	SA142000	1	
144	Nut - Dome	SA106440	1	
145	Rim - Wheel	SA380750	2	
146	Screw - M6 x 20	SA1017230	2	
147	Caps - Front Wheel (Not Illustrated)	SA3006310	2	
148	Wheel - Assembly (Front)	SA3013940	2	(Includes
149	Decal - Grass Blade	410064	1	18,38,61,105,145)
150	Spacer- Front Wheel	SA2018100	2	
151	Bush - Front Wheel	SA2010570	2	
152	Ring - Shaft	SA1013500	2	
153	Spring	SA295940	1	
154	Sleeve	SA281600	1	
155	Nut	SA140260	5	
156	Screw M5 x 16	SA188880	5	
157	Decal	SA690740	1	
158	Tie - Cable	3966	7	
159	Washer	SA152120	10	
160	Sleeve Adjuster	SA281610	2	

PARTS LIST

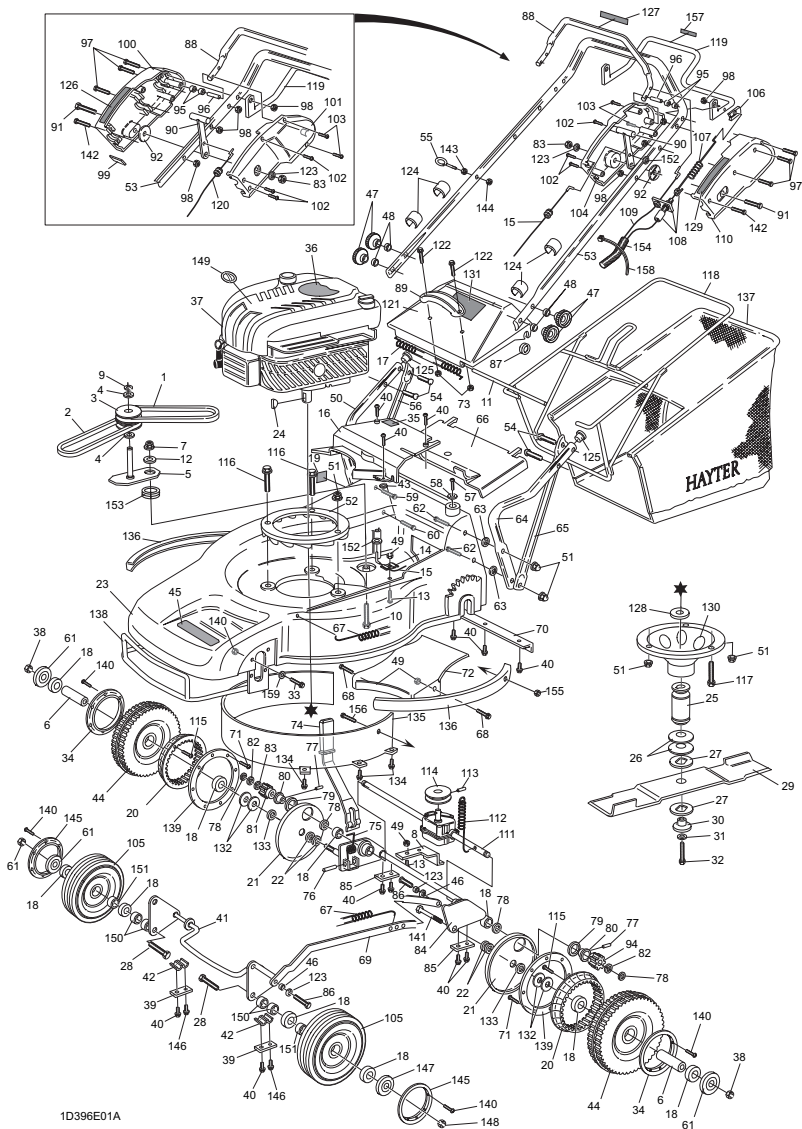

1D396E01A

NOTES

Notes:

Notes:

CUSTOMER INFORMATION

Serial No:

Engine Type: 121602-0315-E1 **Engine:-**Briggs & Stratton Intek Edge 60

Date of Sale:- _____

Your Local Dealer:-

DEALER STAMP

Free Manuals Download Website

<http://myh66.com>

<http://usermanuals.us>

<http://www.somanuals.com>

<http://www.4manuals.cc>

<http://www.manual-lib.com>

<http://www.404manual.com>

<http://www.luxmanual.com>

<http://aubethermostatmanual.com>

Golf course search by state

<http://golfingnear.com>

Email search by domain

<http://emailbydomain.com>

Auto manuals search

<http://auto.somanuals.com>

TV manuals search

<http://tv.somanuals.com>