

Harrier 41 Electric

CODES
309C 311C

OWNER'S HANDBOOK

(English Version)
FROM SERIAL NO's:
309C001001, 311C001001
ISSUE 28.09.04

HANDBOOK: 309054 (REV .0.)

MAIN FEATURES / SPECIFICATIONS

Main Features

- 1 Handlebar Securing Knob.
- 2 Switch Cable.
- 3 Switch Control Unit.
- 4 Switch Control Lever.
- 5 Handlebar.
- 6 Cable Cleat.
- 7 Grassbag Assembly.
- 8 Rear Deflector.
- 9 Serial No. Decal.
- 10 Height Adjuster Handle.
- 11 Supply Cable.

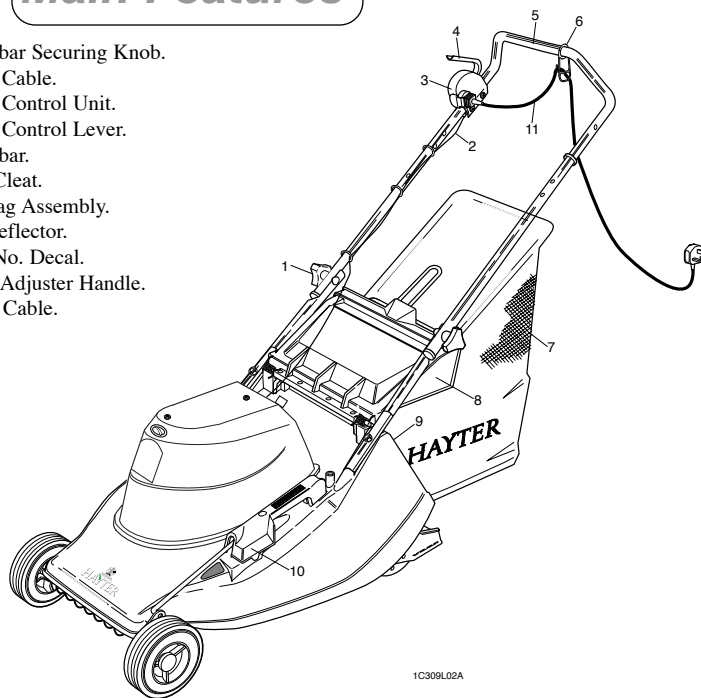

Specifications

Code	309C	311C
Supply	230V~50Hz	230V~50Hz
Rated Input	1.5 kW	1.5 kW
Fuse Rating	13A	13A
Weight	25.5 Kg	25.5 Kg
Cutterblade Speed	2950rpm	2950rpm
Cutting width	410mm	410mm
Cutting height	25 - 65mm	25 - 65mm
Overall dimensions	1,270 x 451 x 1,041mm	1,270 x 451 x 1,041mm
Operator Ear Noise Level	Lpa 80 dB (A)	Lpa 80 dB (A)
Sound Power Level	Lwa 91 dB (A)	Lwa 91 dB (A)

Supply cable: (For European specification - 311C only)

Cable - HO5RNF, 3 x 1 sq. mm. **Appliance coupler** - VDE / CEE7. **Mains plug** - Fused in accordance with the above specifications and compliant with the local standards in the country of use. This item is not included with code 311C mowers due to variation in European mains plug specifications and should be supplied separately by your Hayter Dealer.

CONTENTS

- 1.2 Main Features/Specifications**
- 1.3 Contents**
- 1.4 Introduction**
- 1.5 Warranty**
- 1.6 - 1.9 Safety Precautions**
 - 1.9 Safety Symbols**
 - 1.9 Decal Symbols**
- 1.10 Assembling the Mower**
 - 1.10 - *Delivery Checklist*
 - 1.10 - *Handlebar*
 - 1.10 - *Grassbag Attachment*
 - 1.10 - *Supply Cable*
- 1.11 - 1.15 Operating The Mower**
 - 1.11 - *Electrical Connections*
 - 1.11 - *Starting*
 - 1.11 - *Forward Travel*
 - 1.11 - *Turning*
 - 1.12 - *Stopping*
 - 1.12 - *Height of Cut*
 - 1.12 - *Before Mowing*
 - 1.13 - *Grassbag*
 - 1.13 - *Without Grass Collection*
 - 1.13 - *Heavy Growth*
 - 1.13 - *Non-Grassed Areas*
 - 1.14 - *Safe Mower Practice*
 - 1.15 - *Overloading Protection*
- 1.16 - 1.17 - *Lawn Care Calendar - Guide Only*
- 1.17 - *Lawn Stripes*
- 1.18 Maintenance Schedule**
- 1.19 - 1.22 Mower Maintenance**
 - 1.19 - *Deck Housing*
 - 1.19 - *Securing Nuts and Bolts*
 - 1.19 - *Lubrication*
 - 1.19 - *Motor*
 - 1.19 - *Switch Control Unit*
 - 1.20 - *Cutterblade Removal*
 - 1.20 - *Cutterblade Assembly*
 - 1.21 - *Cutterblade Sharpening*
 - 1.21 - *Supply Cable*
 - 1.22 - *Storage*
- 1.23 - 1.24 Trouble Shooting**
- 1.25 Declaration of Conformity**
- 1.26 - 1.27 Parts List**
 - 1.28 Parts list Diagram**
- 1.30 - 1.31 Notes**
- 1.32 Customer Info**

INTRODUCTION

Thank you for purchasing a **Hayter** mower. The following pages are designed to help you gain safe and efficient service from your mower.

IMPORTANT: This 'Owners Handbook' should be regarded as part of the mower as it gives essential information regarding mower safety, operation, maintenance and specifications. Read and understand this handbook prior to operating your mower for the first time. Make sure you are familiar with all the controls and points of regular maintenance. If you have any doubts, consult your local **Hayter** authorised dealer who will be pleased to give you assistance.

IMPORTANT: This mower is designed solely for use in a domestic grass cutting environment. Use in any other way is considered as contrary to the intended use. Compliance with and strict adherence to the conditions of operation, service and repair as specified in this handbook also constitute essential elements of the intended use.

This mower should be operated, serviced and repaired only by persons who are familiar with its particular characteristics and who are acquainted with the relevant safety procedures.

The safety precautions listed in this handbook and all other generally recognised regulations on safety must be observed at all times.

Any arbitrary modifications carried out to this machine may relieve Hayter Limited of liability for any resulting damage or injury.

Hayter mowers are robustly constructed and designed for efficient economical performance under normal mowing conditions. Correct operation and maintenance will ensure a long and satisfactory service life. Prior to despatch from our factory every effort is made to ensure that your mower is delivered in perfect condition.

Throughout this handbook all references to **left** and **right** are as viewed from behind the handlebar, in the direction of forward travel.

This handbook is based on information available at the time of publication.

HAYTER LIMITED reserve the right to amend product specifications without prior notification.

WARRANTY

LIMITED WARRANTY

Hayter Limited warrants to the original user/purchaser that this unit shall be free from defects in material and workmanship under normal use and service for a period of **three years** from the date of purchase. The manufacturer of major proprietary components ie. engines, gearbox / transaxle (where applicable) furnish their own warranty and services are provided through their authorised network. To qualify for the full benefit of the warranty, the warranty registration card **must** be returned within **14 days** of purchase. Subject to the conditions and exclusions noted in this limited warranty, we shall at our option, repair or replace any warranted part during the applicable period. If you are in doubt or experience any difficulty, please consult a Hayter Authorised Service Dealer for clarification.

To qualify for the extended warranty (second and third year) of the **three year limited warranty** the machine **must** have annual services carried out by an Authorised Hayter Service Dealer. These chargeable services should be carried out within 12 and 24 months of the date of purchase.

Excluded from the extended warranty period are those items which are subject to normal wear and tear e.g. tyres, wheels, cutterblades, belts, cables, grassbags, brush/bristles, batteries and other consumable wearing parts.

All consumer machines which are fitted with a **genuine** Hayter friction disc as original equipment before use, are covered by a **Lifetime Warranty** against the engine crankshaft bending. **Note:** friction washers, blade brake clutch (B.B.C) units and other such devices are not applicable. Only machines fitted with a **genuine** Hayter friction disc, which are used in accordance with the recommended operating and maintenance procedures, are covered.

This warranty does not apply to any unit that has been tampered with, altered, misused, abused or used for hire, and will become invalid if non genuine Hayter parts are fitted. This warranty does not cover minor mechanical adjustments unless they are due to defective material or workmanship. Consult the Owner's Handbook or a Hayter Authorised Service Dealer for assistance when making these adjustments.

A warranty period of 90 days applies to machines used for commercial purposes.

To make a warranty claim, return the unit to a Hayter authorised dealer along with proof of purchase stating the machine serial number and date of purchase. The service receipt(s) or this Owners Handbook with the 1st/2nd year service boxes fully completed, must be produced as proof of entitlement to the extended warranty period. Subject to the conditions and exclusions in this limited warranty, the authorised dealer will, at our option, repair or replace any warranted part within the duration of the warranty period.

This limited warranty gives you specific legal rights and is in addition to any statutory rights to which you may be entitled and your statutory rights are not affected by this warranty. If you need additional information concerning this written warranty, or assistance in obtaining services, please write to : **HAYTER LIMITED, Service Department, Spellbrook, Bishop's Stortford, Hertfordshire CM23 4BU**

UK ONLY: Details of your local **Hayter** authorised dealer are contained in Yellow Pages and the Hayter website www.hayter.co.uk or contact contact:- Freephone 0800 616298.

Issue: 12.08.03

SAFETY PRECAUTIONS

Safety Alert Symbol



This safety alert symbol indicates important safety messages. When you see this symbol be alert to the possibility of injury. Carefully read the following and inform others.

Your mower is perfectly safe if used correctly. Failure to observe the following precautions may result in serious injury.

Training



Read the instructions carefully. Ensure that you are familiar with the controls and the proper use of the equipment. Learn how to stop the mower quickly in an emergency.

Never allow children or people unfamiliar with these instructions to use the mower.

Never mow while people, especially children, or pets are nearby.

Keep in mind that the user is responsible for accidents or hazards occurring to other people or their property.

Preparation



It is recommended that a high sensitivity Residual Current - Operated Circuit - Breaker (RCCB) with a trip current of not more than 30mA is installed at the mains power socket. This will provide the user with additional protection against electric shock. The fuse installed in the plug only provides protection for the electrical equipment and will not safeguard against electrocution. Always check the RCCB before using the mower.

WARNING: Regularly inspect the supply cable for signs of damage or ageing. Replace immediately if defective.

Always wear substantial footwear and long trousers while mowing. Do not operate the equipment when barefoot or wearing sandals.

Thoroughly inspect the area where the mower is to be used and remove all stones, sticks, wires, bones and other foreign objects.

SAFETY PRECAUTIONS

Preparation

Always ensure that the mower is in a safe operating condition. Frequently check all nuts, bolts and screws for tightness. Use only genuine Hayter parts.

Damaged cutterblades and loose fixing bolts are major hazards. Before use, visually inspect the cutting mechanism to ensure that it is in good condition. A damaged cutterblade must be replaced immediately with a genuine **Hayter** replacement part. Cutterblades which are slightly worn can be resharpened. Ensure that both cutting edges are resharpened equally to maintain balance.

An unbalanced cutterblade may cause serious damage to your machine. Refer to "Maintenance."



Operation

SWITCH OFF AND REMOVE PLUG FROM MAINS.

- Before clearing blockages or unclogging the discharge chute.
- Before cleaning, checking or working on the mower.
- Whenever you leave the mower.
- After striking a foreign object. Inspect the mower for damage and make repairs before re-starting and operating the mower.
- If the mower starts to vibrate abnormally (check immediately).
- If the supply cable is entangled.

THE CUTTERBLADE CAN CONTINUE TO ROTATE AFTER THE MACHINE IS SWITCHED OFF.

Keep the supply cable clear of the cutterblade at all times.

Do not mow across the supply cable. Immediately disconnect the cable from the mains supply if this occurs and check for damage. Do not use a defective supply cable.

Mow only in the daylight or in good artificial light.

Avoid using the mower on wet grass, where feasible.

Always be sure of your footing on slopes.

Walk, never run.

Mow across the face of slopes, never up and down.

Exercise extreme caution when changing direction on slopes.

Do not mow excessively steep slopes.



SAFETY PRECAUTIONS

Operation



Use extreme caution when reversing or pulling the mower towards you.

Switch off if the mower has to be tilted for transportation when crossing surfaces other than grass and when transporting the mower to and from the area to be mowed.

Never operate the mower unless the guards are securely in position and in good condition.

Start the mower carefully, with feet well away from the cutterblade.

Do not tilt the front of the mower more than is absolutely necessary when starting.
Never lift the rear of the mower.

Do not put hands or feet near or under rotating parts.

Never pick up or carry a mower while it is running or connected to the mains supply.

Do not lift the rear deflector plate whilst the mower is in operation, particularly when using without a grassbag.

Maintenance & Storage



Keep all nuts, bolts and screws tight to ensure that the mower is in a safe working condition.

Carefully examine the supply cable for signs of damage or ageing. Replace immediately if defective.

Check the grassbag frequently for wear or deterioration and replace if necessary.

Wear strong work gloves when removing and reassembling the cutterblade.

Replace worn or damaged parts for safety.

SAFETY PRECAUTIONS

Safety Symbols

Safety Alert - Be aware to the possibility of injury.



Danger of severing toes or fingers in cutting mechanism.

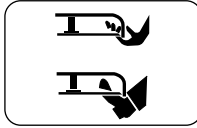

Danger of being hit by thrown objects.



Carefully read the Owners Handbook before using the machine.



Switch off and remove plug from mains before performing maintenance or repair work.

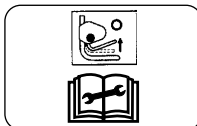

Keep bystanders at a safe distance from the mower.

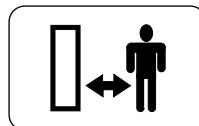

⚠ WARNING ⚠

- SWITCH OFF, REMOVE PLUG FROM MAINS BEFORE ADJUSTING, CLEANING OR IF THE SUPPLY CABLE IS ENTANGLED OR DAMAGED.
- READ THE OWNERS HANDBOOK.
- KEEP THE SUPPLY CABLE AWAY FROM THE CUTTERBAR.
- CUTTERBAR CONTINUES TO ROTATE AFTER THE MACHINE IS SWITCHED OFF.
- ENSURE THAT THE REAR GRASS DEFLECTOR IS SECURED IN PLACE.

Electrical Specification
220 - 240V ~ 50Hz 1500W

Control Symbols

Switch
(Symbol)

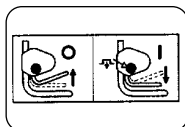

Height of Cut Adjustment
(Symbol)



Height of Cut Indicator
(Symbol)

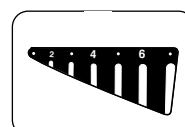

ASSEMBLING THE MOWER

Delivery Checklist

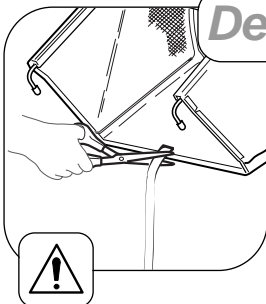

Remove the mower from the packaging and check that the following items have been supplied correctly. If any items are missing contact your local Hayter dealer.

1. Owner's Handbook.
2. Grassbag.
3. Supply Cable - (309C Only)

To prevent accidents cut off the long ribbon attached to the grassbag and discard.

Handlebar

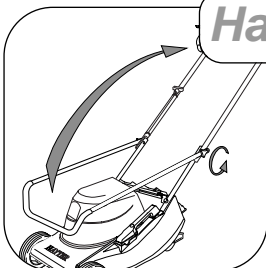

Unscrew the handlebar securing knobs sufficiently to allow the handlebar to pivot. Unfold the handlebar to the operating position, before releasing. Tighten both handlebar knobs to secure in position.

Take care to ensure that the control cables do not become snagged at the pivot point.

Grassbag Attachment

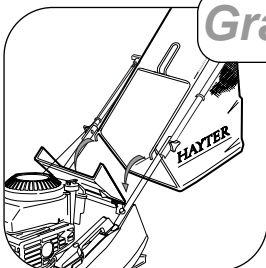

Raise the rear deflector, lower the grassbag through the handlebar and hook in position. Lower the deflector to rest on the grassbag

Supply Cable

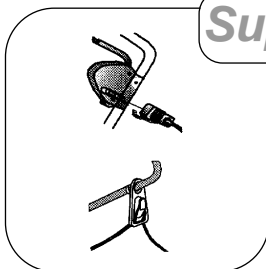

Unpack the supply cable and identify the female socket end which is to be attached to the mower. Fold back the hinged protector cap and plug into the handlebar switch control unit. The hinged cap should snap into position behind the control unit when fully engaged.

Route the supply cable loosely across to the cable cleat on the left side of the handlebar. Make a loop in the supply cable and secure to the cable cleat.

1.10

OPERATING THE MOWER

Electrical Connection

Position the mower on the grass area to be cut. Carefully uncoil the supply cable clear of the mower and take the plug end connection to the mains socket outlet. Ensure that the mains socket is switched 'OFF' before locating the RCCB unit - Refer to "Safety Precautions" - Preparation. Switch 'ON' and check the operation of the RCCB unit. Switch 'OFF' before installing the mower supply cable plug and finally switch on.

Starting

Locate the switch control lever mounted on the handlebar and ensure that your feet are clear of the mower deck. Depress the safety button with the left hand and pull the lever towards the handlebar with the right hand. The motor will now start. The safety button will remain depressed until the lever is released.

Failure to depress the safety button before operating the lever can cause permanent damage to the switch control unit.

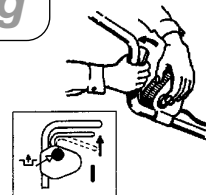

Forward Travel

Hold and push against the handlebar with both hands to move the mower forwards.

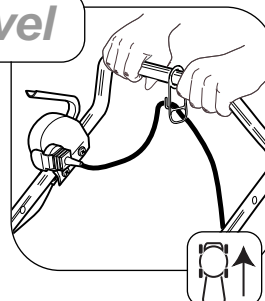

Turning

To make a wide turn steer the mower with the handlebar whilst travelling forward.

To make a tight turn apply downward pressure on the handlebar to raise the front wheels of the mower just above ground level and steer the mower using the handlebar in the required direction.

To prevent accidents do not raise the front of the mower excessively when making a turn. Never raise the rear of the mower when the motor is running.



1.11

OPERATING THE MOWER

Stopping

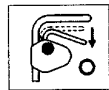

Release the motor switch control lever to stop the motor.

WARNING: AVOID ACCIDENTS - The cutterblade may continue to rotate after the mower is switched off

Height of Cut

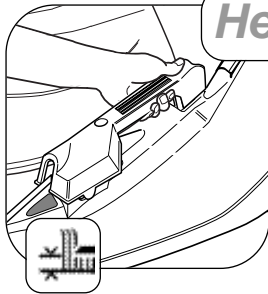

Hold the trigger against the handle and raise or lower the mower using the handle to achieve the desired height of cut. Release the trigger to secure the mower at the required position.

There are seven height of cut positions. The setting is indicated by the position of the connecting rod relative to the height of cut indicator.

Always select a height of cut to suit operating conditions. Aim to prevent motor overloading and blockages by avoiding low cuts in long grass conditions. Be prepared to make two cuts when the grass is long.

Before Mowing



To prevent accidents thoroughly inspect the area and remove all objects which when contacted by the mower cutterblade could become dangerous projectiles. Inspect the area for hidden obstructions which when contacted by the cutterblade could risk health and safety. Remember the location of these obstructions and ensure that you mow around them.

OPERATING THE MOWER

Grassbag

Raise the rear deflector and lift the grassbag through the handlebar and lower the rear deflector to rest against the rear of the mower.

To empty the grassbag, pour out the grass clippings and shake the grassbag vigorously to clean the airways. Good grass collection depends on good air flow through the grassbag. When collecting grass clippings it is important that the grassbag is emptied regularly to prevent blockages and motor overloading.

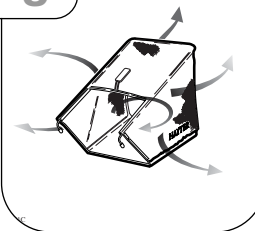

Without Grass Collection

Remove the grassbag and operate the mower with the rear deflector in the closed position.

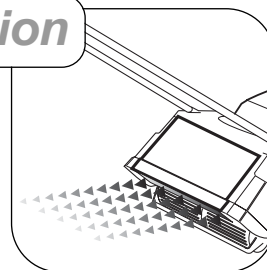

Heavey Growth

Areas of heavy growth should be mown without collecting the clippings. If collection is required, first mow the area without the grassbag at the maximum height of cut setting. Allow the grass clippings to dry out and then mow the area at the maximum height of cut setting with the grassbag fitted. Reduce the height of cut and mow the area again as necessary until the required finish is obtained.

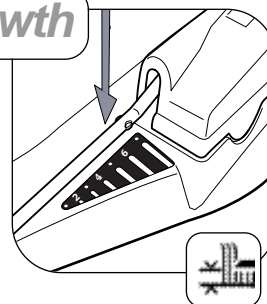

To prevent grass damage do not remove more than one third of grass height in one cut.

Non-Grassed Areas

When moving the mower across non-grassed areas, stop the motor and set the mower to the maximum height of cut to protect the cutting mechanism.

OPERATING THE MOWER

Safe Mower Practice



WARNING: PREVENT ACCIDENTS -Take extreme care do not mow across the supply cable. If this should occur, switch off immediately and disconnect the plug from the power supply. Carefully examine the cable for cuts and damage. A defective cable must be replaced before the mower is used again. Always be aware of the location of the supply cable in relationship to the mower and the grass area. Do not allow the cable to become hidden in uncut grass. Keep the cable over the cut area at all times. A cable which is out of sight is out of mind and this could lead to a hazardous situation. Plan a 'cutting scheme' which works away from the power supply point and ensures that the cable is trailed out over the cut area. Work up and down the lawn in rows. Turn the machine round at the end of the row and step across the cable so that the cable is trailed along in the cut area on the return run.

When working around flower beds, prevent the cable from trailing across the cultivated area by positioning a stake at the corner of the bed. Do not allow the cable to be pulled around sharp obstructions. Stop mowing immediately if cable resistance is felt and remove the obstruction. Do not allow the cable to become entangled.

WARNING: PREVENT ACCIDENTS - Switch off, remove plug from mains before adjusting, cleaning or if the cable is entangled.

OPERATING THE MOWER

Overloading Protection

Do not let the motor labour or slow down through being overloaded in work. When this situation occurs, raise the front of the mower slightly by bearing down on the handlebar, allow the motor to reach maximum speed and proceed to mow at a slower pace. Alternatively readjust to a higher cut position. If the motor continues to labour, switch off and remove the plug from the mains supply. Remove and empty the grassbag. Examine the discharge chute and remove any blockage. Turn the machine on its side and clear any obstruction from the cutterblade and the underside of the mower deck. Place the machine upright and replace the grassbag. Readjust to a higher cut position if necessary. Restart the mower and proceed to mow at a pace which does not overload the mower.



IMPORTANT: PREVENT DAMAGE - DO NOT continue to operate the motor in an overloaded condition. If this does occur, stop mowing and allow the motor to run at maximum speed for one minute. This will allow the motor to cool down to its normal working temperature.

LAWN CARE CALENDAR

To be used as a guide only..

January

There is very little work to do this month apart from brushing away leaves. Keep off the grass if frozen or waterlogged.

February

Rake the grass thoroughly. Spike the lawn to aerate and stimulate soil organisms and root growth and apply lawn sand if necessary.

March

The yearly lawn work programme really starts this month. As soon as the ground conditions are suitable, the first cut can be made. The first cut should merely "top" the grass as close cutting at this stage could result in severe yellowing or browning. Two cuts are generally sufficient this month.

April

Mow often enough to stop grass growing away. Dig out patches of coarse grass or resistant weed. Re-seed bare patches.

May

Keep mowing increasing the frequency as required. Treat with selective weed killers or combined weed/feed preparations if you did not feed the lawn in April.

June

Summer mowing should now be under way. It should be necessary to mow the lawn twice a week. Raking before mowing is important this month as the combined action keeps runners of clover under control. Water the grass if necessary, and remember to soak thoroughly.

July

Treat the grass with the second application of fertiliser or weed killer/fertiliser. Water when necessary and rake occasionally. As a general rule the grass clippings should be removed each time you mow. If weather conditions are dry and hot and the grass is weed free, leave the clippings on the lawn to help maintain ground moisture.

LAWN CARE CALENDAR

August

Keep mowing regularly and watering as necessary. Fill any cracks caused by drought with a mixture of sharp sand and soil. In dry weather conditions leave the grass longer to help retain ground moisture.

September

Raise the height of cut to allow the grass to thicken and protect the roots from the winter frost and snow.

October

Rake out the thatch from the turf and spike the lawn to assist in drainage. Brush in peat and sharp sand.

November

Use a stiff broom to disperse worm casts before mowing. Keep turf free from leaves.

December

Apart from brushing away leaves, December is a slack end of a busy year. Keep off the lawn if it is very wet or frozen.

Lawn Stripes

The way to achieve a neat striped effect is for the lawn being cut in parallel stripes, alternate stripes being mown in opposite directions. A much more important routine is to cut at right angles to the line of the previous mowing. If the work has been carried in a north-south line, then the next cutting should be in an east-west direction. The cross-cutting keeps down the coarse weed grasses.

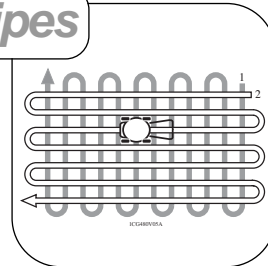

To prevent grass damage do not remove more than one third of the grass height in one cut.

MAINTENANCE SCHEDULE

Follow the hourly or calendar intervals, whichever occurs first. More frequent service will be required if working for prolonged periods under dusty, dry conditions, or when airborne debris is present or after extensive operation cutting tall, dry grass.

Daily

- Remove grass debris from around the motor and air ways in the cowl and underside of the deck housing.
- Remove grass debris from the grassbag and check for signs of damage.
- Check the condition of guards and safety devices.
- Check condition of cutterblade.

25-50 Hrs or Every Season

- Lubricate wheels, pivot points and linkages and grease the inner control cables at point of entry and exit from their outer casing.
- Sharpen the cutterblade.
- Flash test (Dealer) to ensure complete safety.
- Check cables/switch and connection

MOWER MAINTENANCE

Deck Housing

Remove grass debris from the top and underside of the deck housing immediately after use.

To prevent accidents fertilisers and top dressings are particularly corrosive. Thoroughly clean the mower deck immediately after use on treated grass and store well away from corrosive materials.

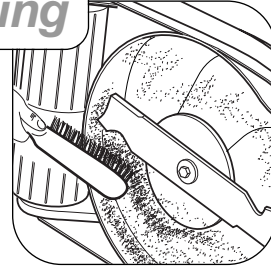

Securing Nuts & Bolts

Regularly check that all securing nuts and bolts are tight. Replace missing or damaged items immediately.

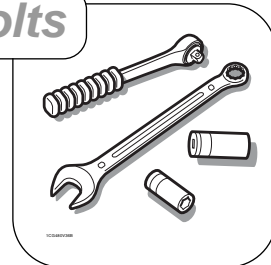

Lubrication

Lubricate the wheels, pivot points and linkages with engine oil every 25 operating hours.

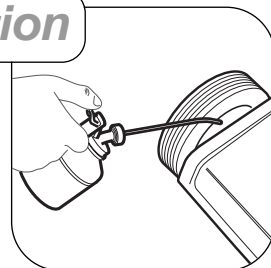

Motor

The motor is maintenance free.

Switch Control Unit

The switch control unit is maintenance free.

MOWER MAINTENANCE

Cutterblade Removal

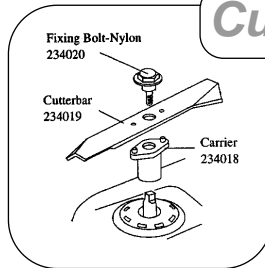

Turn the mower on its side.

Firmly grip the end of the cutterblade with a gloved hand and remove the bolt. The carrier may be removed from the shaft. This should be cleaned and replaced. Ensure that the flats on the shaft locate correctly with the flats on the carrier. Ensure that the new cutterblade is the correct way up with the turned edges facing towards the motor before locating onto the two carrier pins. Secure the cutterblade fixing bolt-insulating and tighten to the specified torque of 27Nm.

The cutterblade has sharp edges. ALWAYS wear strong gloves to protect your hands when working on the cutterblade. DO NOT rotate tools towards the cutting edges to avoid the risk of injury should the tool slip. ALWAYS use genuine Hayter replacement parts.

The condition of the cutterblade and its mounting arrangement should be checked regularly for signs of wear or damage. Ensure that the cutterblade is not bent or cracked.

A damaged cutterblade that is out of balance will vibrate excessively and may break. **DO NOT** use an unbalanced cutterblade.

Regularly check that the bolt securing the cutterblade is tightened to the specified torque of 27Nm.

Replace the cutterblade every 2 years or sooner if excessively worn or damaged.

To prevent injury it is wise to seek assistance when turning the mower on its side.

MOWER MAINTENANCE

Cutterblade Sharpening

A slightly worn cutterblade may be re-sharpened. Both blade edges must be sharpened equally to ensure balance. Sharpen the cutterblade every 25 mowing hours or more frequently if conditions require. Remove the cutterblade from the mower and clean using a brush and water. Inspect the cutterblade for signs of damage. Sharpen both cutting edges with a flat file to restore performance.

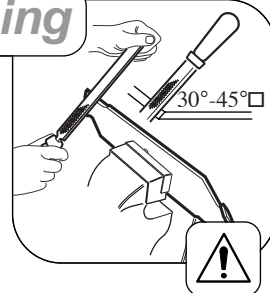

Ensure that the cutterblade is balanced. Use a screw driver with a round shaft to support the cutterblade through its centre hole. Hold the cutterblade horizontal and then release. A balanced cutterblade will remain horizontal.

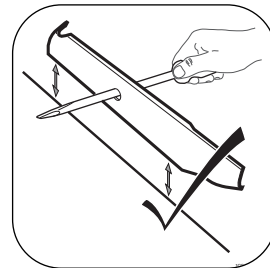

If the cutterblade is not balanced the heavy end will rotate downwards. Sharpen the heavy end until the cutterblade is correctly balanced.

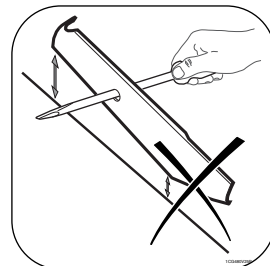

Supply Cable

Check the condition of the supply cable for damage or ageing. Replace immediately if defective.

MOWER MAINTENANCE

Storage

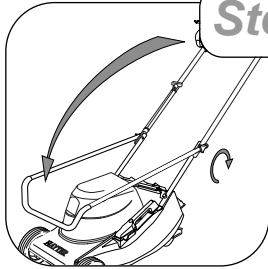

Handlebar storage: To lower the handlebar unscrew the 2 securing knobs sufficiently to allow it to be pivoted forwards to rest against the mower. Take care to ensure that the power cable does not become snagged at the pivot point.

Storage for long periods: To ensure your mower is maintained in good working order it is important that the following procedure is adopted when the mower is stored for periods in excess of one month. Refer to the Maintenance section as necessary.

Clean all areas of the mower and ensure that the grassbag is clean.

Lubricate the mower.

Treat metal parts with a water repellent anti-corrosion product.

Lower the handlebar if desired.

Cover the mower with a protective sheet and store it in a dry area.

Rest the mower deck on wooden blocks to remove the weight of the mower from its wheels / roller.

TROUBLE SHOOTING

PROBLEM	POSSIBLE FAULT	REMEDY
Motor fails to start.	Mains supply socket dead.	Test socket by plugging in another appliance.
	RCCB tripped.	Remove mower plug and check RCCB action. Check the supply cable for any obvious signs of damage and replace immediately if defective. If no obvious faults are found a serious fault is indicated. Contact your Hayter Dealer.
	Plug pulled out of mains socket.	Re-engage plug.
	Fuse failure.	Fit a new 13 amp fuse.
	Supply cable damaged.	Disconnect from the mains and check the supply cable for any obvious signs of damage. Replace immediately if defective.
	Cutterblade obstructed.	Disconnect from the mains and remove any obstructions.
	Cable socket pulled out of switch control unit.	Re-engage cable socket.
Motor will not stop.	Faulty switch control unit.	Ensure switch lever has returned to the ' OFF ' position. Disconnect from the mains and contact your Hayter Dealer.
Cutterblade runs on excessively after switching ' OFF '.	Faulty brake unit.	Contact your Hayter Dealer.

TROUBLE SHOOTING

PROBLEM	POSSIBLE FAULT	REMEDY
Motor vibrates excessively.	Mounting bolts loose. Cutterblade bolt loose. Cutterblade out of balance.	Tighten bolts. Tighten bolt. Balance cutterblade.
Uneven cut	Undulating ground contours. Cutterblade worn. Cutterblade out of balance. Wheels / Roller damaged.	Change direction of travel. Sharpen the cutterblade. Balance cutterblade. Inspect and replace as necessary.
Discharge chute blocks.	Grass is wet. Cut height too low. Grassbag full. No airflow through the grassbag.	Mow dry grass. Increase cut height. Empty grassbag. Clean the grassbag.
Mower is hard to push.	Cut height too low. Wheels / Roller damaged.	Increase cut height. Inspect and lubricate or replace as necessary.
Poor grass collection.	No airflow through the grassbag. Discharge chute blocked. Wet grass. Grassbag full.	Clean the grassbag. Remove blockage. Mow dry grass. Empty grassbag.

DECLARATION OF CONFORMITY

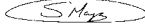
EC DECLARATION OF CONFORMITY		
HAYTER LIMITED, Spellbrook, Bishop's Stortford, Herts CM23 4BU ENGLAND		
declare that the lawnmowers:		
Models:	Harrier 41	Harrier 41
Machine Type No.	CODE 309C	CODE 311C
Category:	Push Electric	Push Electric
Type:	Pedestrian Rotary	Pedestrian Rotary
Motor: Manufacturer:	ATB Austria 1.5kw	ATB Austria 1.5kw
Speed of rotation:	2950 rpm	2950 rpm
Width of cutting device:	410mm	410mm
Speed of rotation of the cutting device:	2950 rpm	2950 rpm
Complies with the provisions of Directive: 98/37/EC Essential Health & Safety Requirements Relating to the Design & Construction of Machinery and Safety Components, as amended and the regulations transposed into national law.		
Also Directive 89/336/EEC Electromagnetic Compatibility, as amended and the regulations transposed into national law.		
Also Directive 2000/14/EC Noise emission in the environment by equipment for use outdoors, and the regulations transposed into national law procedure applied for the conformity assessment: ANNEX VI, procedure 1. Notified Body: Sound Research Laboratories Ltd. Holbrook House, Little Waldingfield, Sudbury, Suffolk, ENGLAND Notified body identification No: 1088		
Measured sound power level:	91 dB(A)	91 dB(A)
Guaranteed sound power level:	96 dB(A)	96 dB(A)
Standards Used: EN2921, EN836 and EN55014, EN61000-3-2, EN61000-3-3		
Signed 	Date: 28.09.04	Declaration done and Technical Documentation kept at: HAYTER LIMITED, Spellbrook, Bishop's Stortford, Herts CM23 4BU ENGLAND
S.A. Maryniak (Technical Director)		

VIBRATION INFORMATION

Lawnmower vibration information. RMS acceleration measured in 3 - axes at operators contact position on the handlebars. **CODE 309C = 1.1 ms⁻², CODE 311C = 1.1 ms⁻².**

PARTS LIST

ITEM NO.	DESCRIPTION	PART NO.	QTY.		ITEM NOTE
			309	311	
1	Deck	305101V	1	1	
2	Handle Height Adjuster	305112	1	1	
3	Screw - M6 x 16	09596	6	6	
4	Spring - Trigger	300067	1	1	
5	Trigger	300066	1	1	
6	Screw - M6 x 20 Taptite	09575	3	3	
7	Ferrule - Plastic Dia. 8	305115	2	2	
8	Spring - Deflector R/H	305111	1	1	
9	Spring - Deflector L/H	305110	1	1	
10	Coachbolt - M8 x 45	09569	2	2	
11	Compensating Spring	300070	1	1	
12	Washer - Plain M6	09472	6	6	
13	Throwplate	300124	1	1	
14	Pillar	300137	1	1	
15	Nut - M6 Nylon Ins 'T' Type	09544	1	1	
16	Plate - Securing	219037	3	3	
17	Screw - 6 x 16 Pozidrive	09634	2	2	
18	Grip-Fix	02385	2	2	
19	Rear Roller Frame	308050W	1	1	
20	Washer - 3/8" Plain	09271	2	2	
21	Nut - 3/8" UNF	09216	1	1	
22	Axle Support	305130	1	1	
23	Screw - M6 x 16 Hex W/Hd	09365	2	2	
24	Roller - Black	201007	2	2	
25	Hub Cap	219143	2	2	
26	Nut - Wheel Nyloc	4486	2	2	
27	6" Wheel	305016	2	2	
28	Screw - M6 x 12	09546	4	4	
29	Axle Bush	305108	2	2	
30	Axle - Front Assembly	300111	1	1	
31	Rod - Connecting	305109	1	1	
32	Cutterblade	234019	1	1	
33	Carrier	234018	1	1	
34	Axle Bolt	308021	1	1	
35	Decal - Hayter / Royal Warrant	410087	1	1	
36	Decal - Height of Cut	305113	1	1	
37	Decal - Hand and Foot	331045	1	1	
38	Fixing Bolt - Nylon	234020	1	1	
39	Nut - M8 Nylon Ins. 'P'	09442	5	5	
40	Washer - M8	09475	5	5	

PARTS LIST

ITEM NO.	DESCRIPTION	PART NO.	QTY.		ITEM NO
			309	311	
41	Base Plate Motor	309019	1	1	
42	Motor Flange	309024	1	1	
43	Bolt - M8 x 40 Hex. Hd	09681	3	3	
44	Motor Screen	309025	1	1	
45	Capacitor	309039	1	1	
46	Screw - No. 14 x 1.1/4" Self Tap	09670	4	4	
47	Motor - 1.5 kw	309052	1	1	
48	Motor Cover Mk2	309046	1	1	
49	Screw - No. 14 x 1.1/2" Self Tap	09669	4	4	
50	Cable Clip	70-09-109	1	1	
51	Motor Cover Top	309020	1	1	
52	Decal - Harrier 41 Electric	309040	1	1	
53	Screw - No.8 x 1" Plastite	09528	2	2	
54	Decal - Warning	309028	1	0	
	Decal - Warning	311012	0	1	
55	Handlebar - Lower RH	309033	1	1	Inc. Insulator
56	Handlebar - Lower LH	309034	1	1	Inc. Insulator
57	Plug - Tube	320048	2	2	
58	Handwheel	226013	2	2	
59	Bolt - M8 x 45 Handlebar	226024	2	2	
60	Cable Tie	3966	3	3	
61	Switch	309026	1	0	
	Switch	311010	0	1	
62	Screw - Ejot KA40 x 25	09719	2	2	
63	Coupler Cable Assembly	309027	1	0	
64	Hose Clip - Black	234029	1	1	
65	Cleat	234014	1	1	
66	Frame - Grassbag	305105W	1	1	
67	Fabric - Grassbag	305104	1	1	
68	Grassbag Assembly	305118	1	1	Inc. items 25 & 32
69	Handlebar - Upper	309036	1	1	
70	Deflector	305102	1	1	
71	Decal - Serial Number	N/A	1	1	
72	Pin - 6.35 x 295	305103	1	1	
73	Decal - Grass Blade	410064	1	1	

PARTS LIST

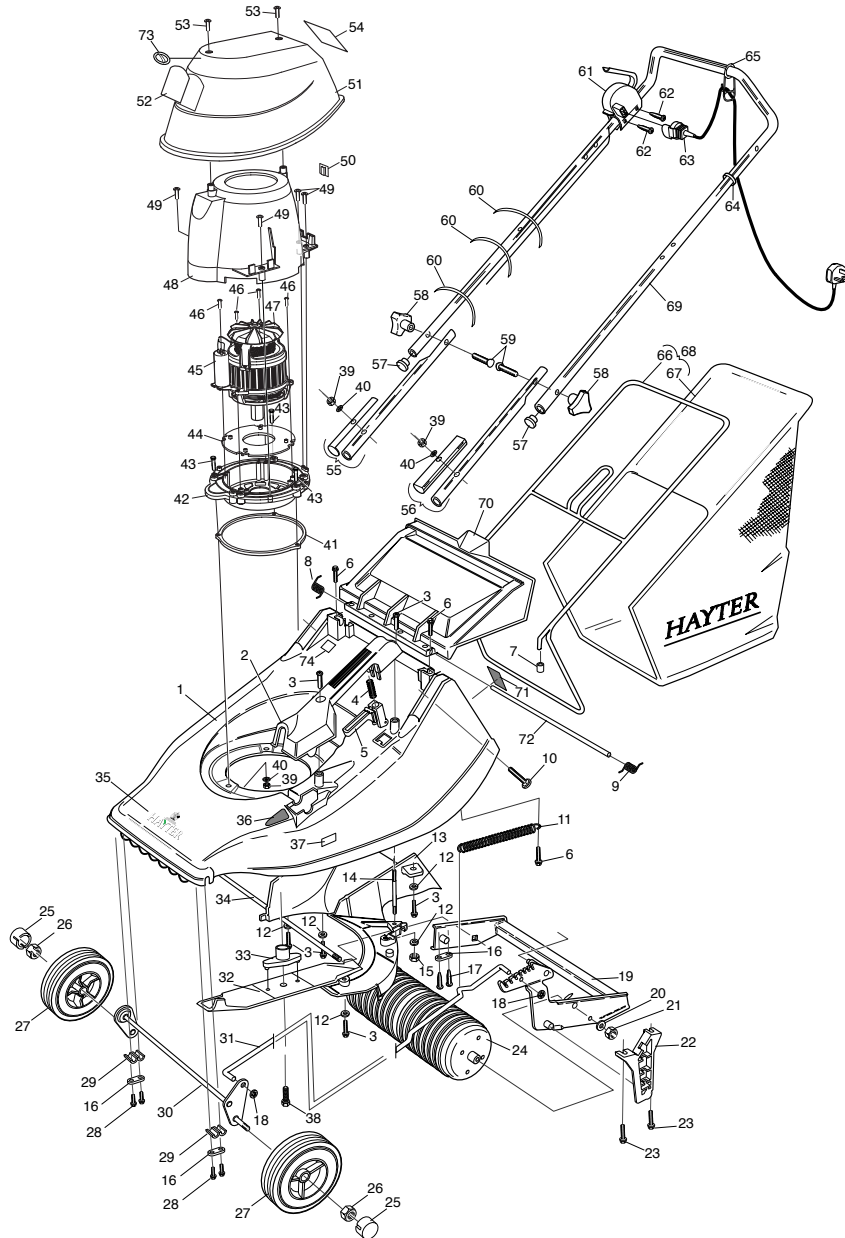

1C309L03A

NOTES

Notes:-

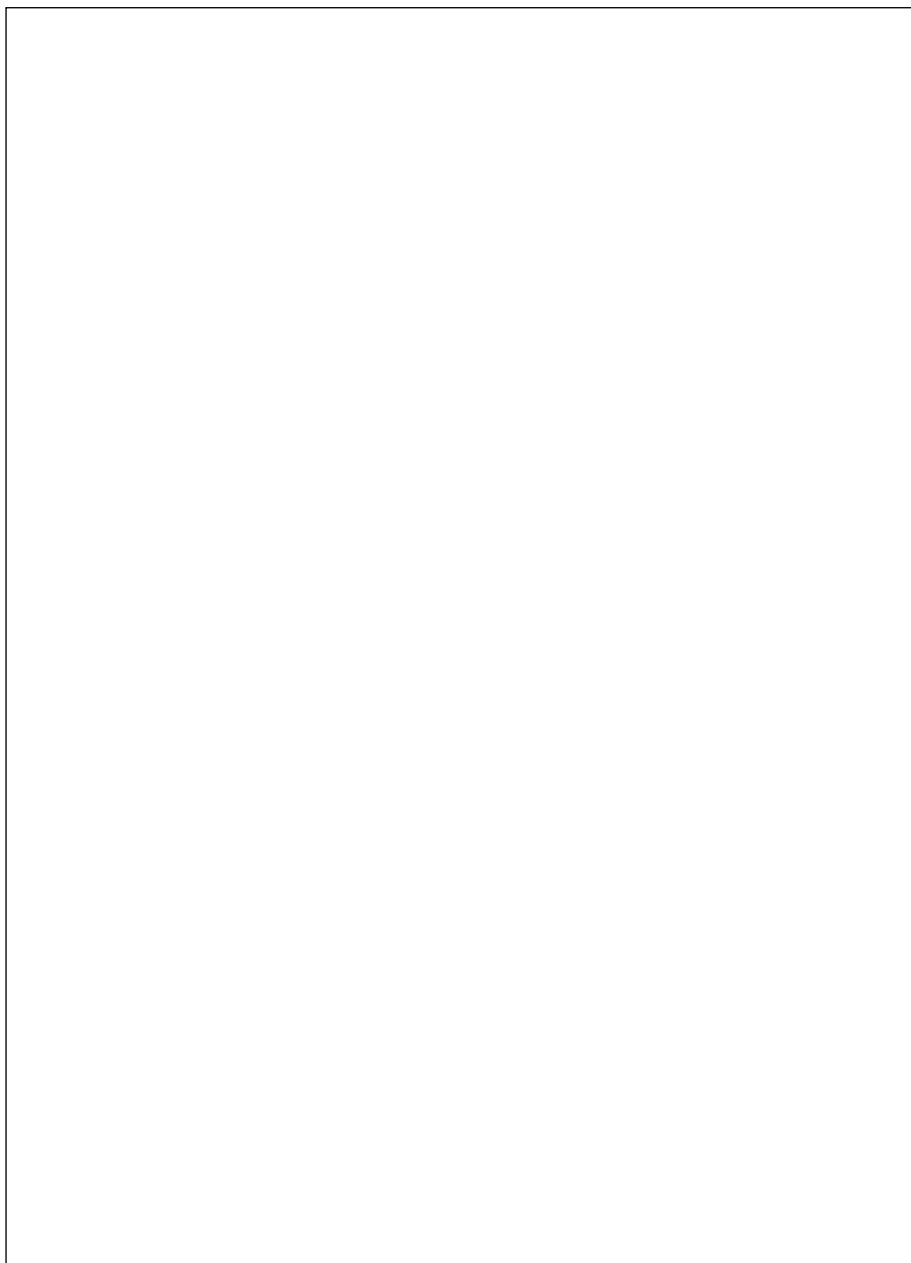

NOTES

Notes:-

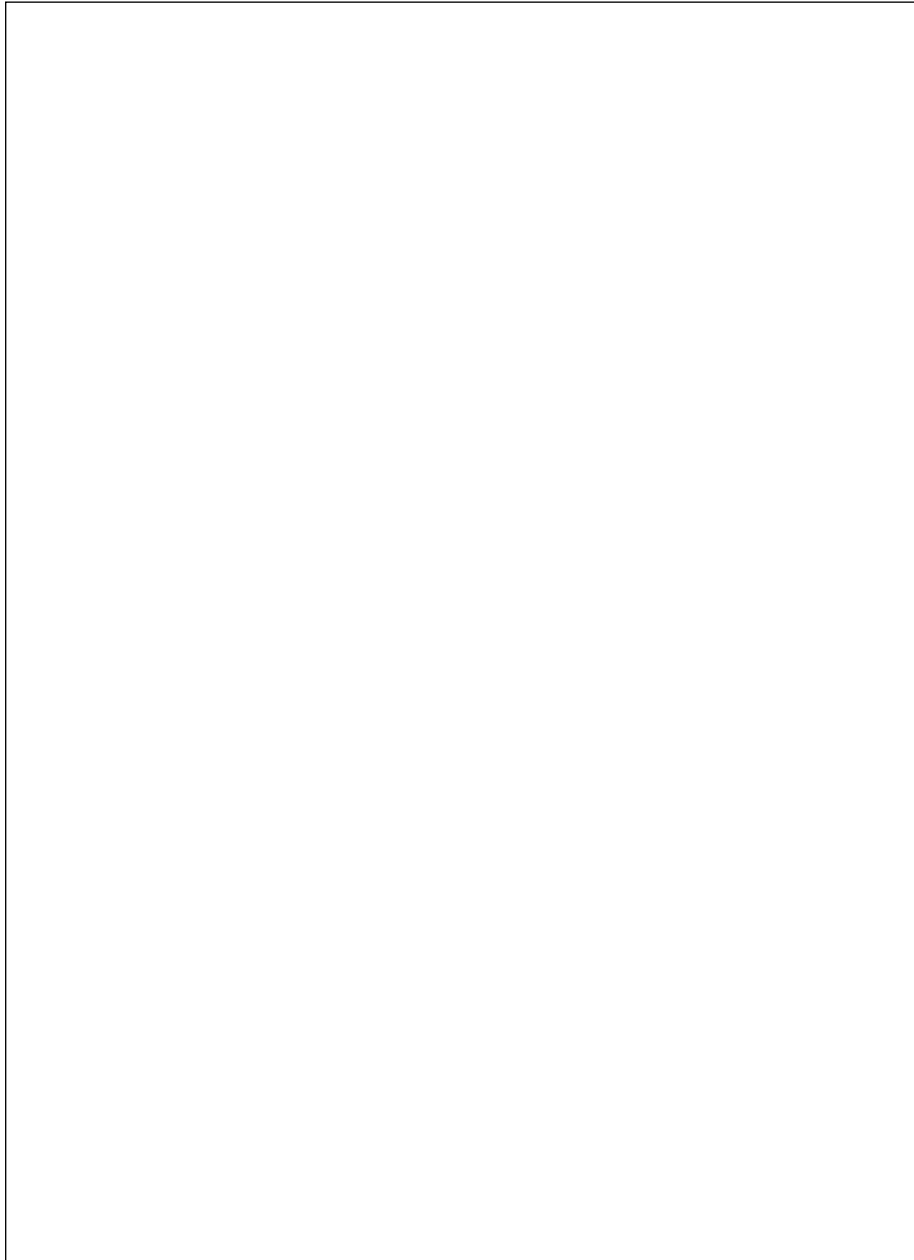

1.30

NOTES

Notes:-

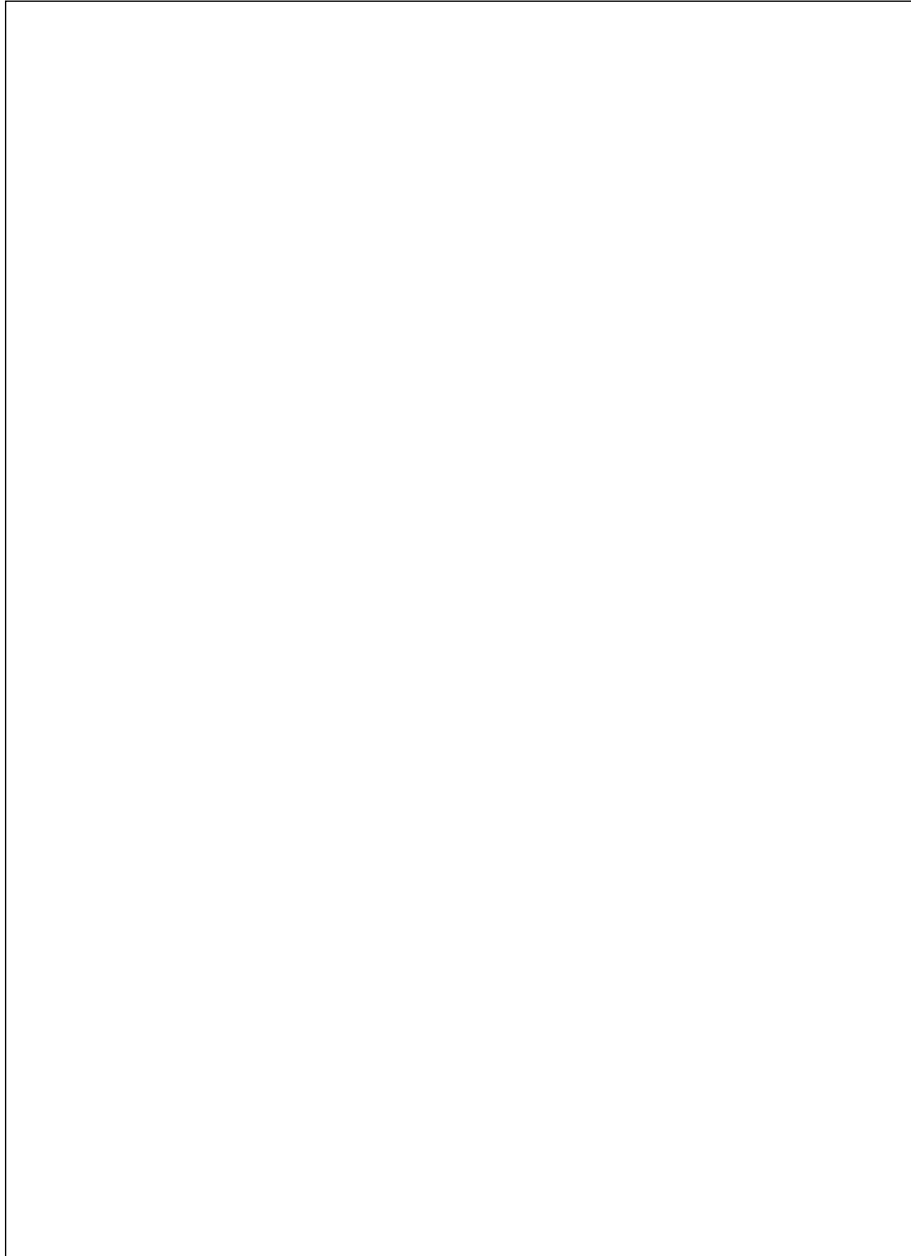

CUSTOMER INFORMATION

Serial No:

Motor Type:-ATB Austria 1.5kw Code 309C

Motor Type:-ATB Austria 1.5kw Code 311C

Date of Sale:- _____

Your Local Dealer:-

DEALER STAMP

Free Manuals Download Website

<http://myh66.com>

<http://usermanuals.us>

<http://www.somanuals.com>

<http://www.4manuals.cc>

<http://www.manual-lib.com>

<http://www.404manual.com>

<http://www.luxmanual.com>

<http://aubethermostatmanual.com>

Golf course search by state

<http://golfingnear.com>

Email search by domain

<http://emailbydomain.com>

Auto manuals search

<http://auto.somanuals.com>

TV manuals search

<http://tv.somanuals.com>