

# HEALTHRIDER

S O F T S T R I D E R

S700xi

## USER'S MANUAL

Model No. HRTL16900

Serial No. \_\_\_\_\_

Write the serial number in the space above for future reference.

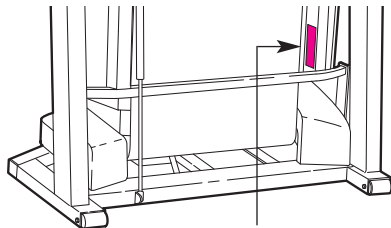

Serial Number Decal

### QUESTIONS?

As a manufacturer, we are committed to providing complete customer satisfaction. If you have questions, or if there are missing parts, we will guarantee complete satisfaction through direct assistance from our factory.

**TO AVOID UNNECESSARY DELAYS, PLEASE CALL DIRECT TO OUR TOLL-FREE CUSTOMER HOT LINE.** The trained technicians on our customer hot line will provide immediate assistance, free of charge.

**CUSTOMER HOT LINE:**

**1-800-999-3756**

Mon.-Fri., 6 a.m.-6 p.m. MST

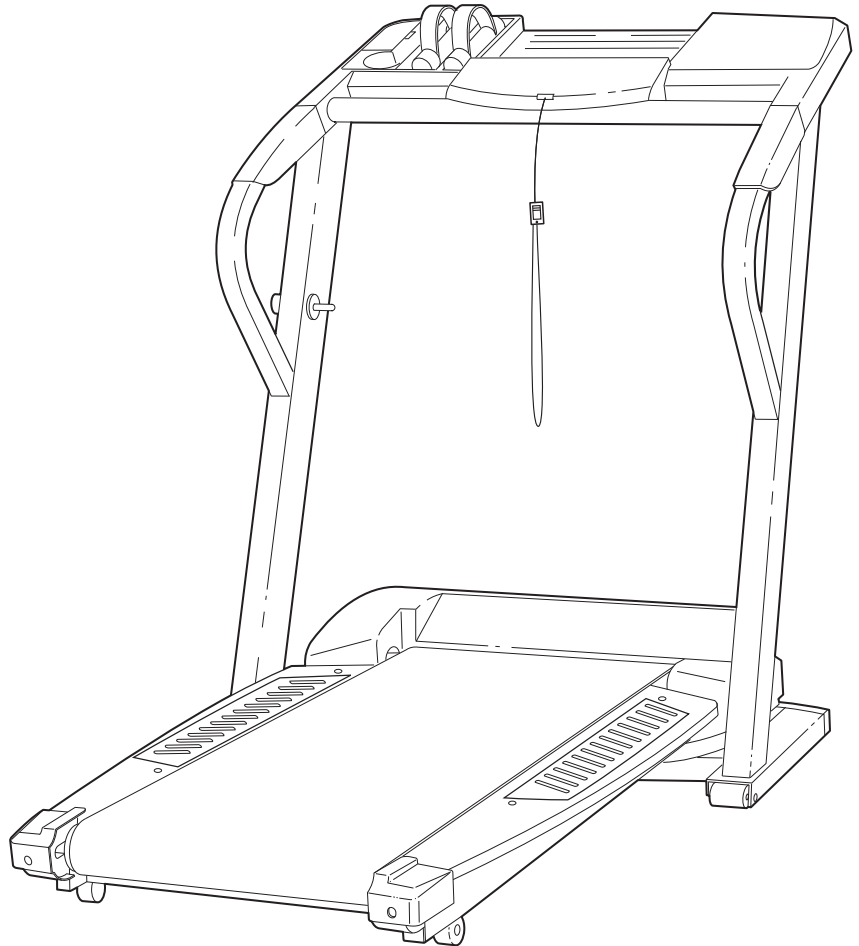

### ⚠ CAUTION

Read all precautions and instructions in this manual before using this equipment. Save this manual for future reference.



Visit our website at

[www.healthrider.com](http://www.healthrider.com)

*new products, prizes,  
fitness tips, and much more!*

# TABLE OF CONTENTS

IMPORTANT PRECAUTIONS .....	2
BEFORE YOU BEGIN .....	4
ASSEMBLY .....	5
HOW TO USE THE CHEST PULSE SENSOR .....	6
OPERATION AND ADJUSTMENT .....	7
HOW TO FOLD AND MOVE THE TREADMILL .....	23
TROUBLE-SHOOTING AND MAINTENANCE .....	25
CONDITIONING GUIDELINES .....	28
PART LIST .....	30
HOW TO ORDER REPLACEMENT PARTS .....	31
LIMITED WARRANTY .....	Back Cover

Note: An EXPLODED DRAWING is attached in the center of this manual.

## IMPORTANT PRECAUTIONS

**⚠ WARNING:** To reduce the risk of burns, fire, electric shock, or injury to persons, read the following important precautions and information before operating the treadmill.

1. It is the responsibility of the owner to ensure that all users of this treadmill are adequately informed of all warnings and precautions.
2. Use the treadmill only as described in this manual.
3. Place the treadmill on a level surface, with eight feet of clearance behind it. Do not place the treadmill on any surface that blocks air openings. To protect the floor or carpet from damage, place a mat under the treadmill.
4. Keep the treadmill indoors, away from moisture and dust. Do not put the treadmill in a garage or covered patio, or near water.
5. Do not operate the treadmill where aerosol products are used or where oxygen is being administered.
6. Keep children under the age of 12 and pets away from the treadmill at all times.
7. The treadmill should not be used by persons weighing more than 300 pounds. Never allow more than one person on the treadmill at a time.
8. Wear appropriate exercise clothing when using the treadmill. Do not wear loose clothing that could become caught in the treadmill. Athletic support clothes are recommended for both men and women. *Always wear athletic shoes. Never use the treadmill with bare feet, wearing only stockings, or in sandals.*
9. When connecting the power cord (see page 7), plug the power cord into a surge suppressor (not included) and plug the surge suppressor into a grounded circuit capable of carrying 15 or more amps. No other appliance should be on the same circuit.
10. Use only a single-outlet surge suppressor that is UL 1449 listed as a transient voltage surge suppressor (TVSS). The surge suppressor must have a UL suppressed voltage rating of 400 volts or less and a minimum surge dissipation of 450 joules. The surge suppressor must be electrically rated for 120 volts AC and 15 amps. To purchase a surge suppressor, see your local HEALTHRIDER dealer or call 1-800-999-3756 and order part number 146148.
11. Keep the power cord and the surge suppressor away from heated surfaces.
12. Never move the walking belt while the power is turned off. Do not operate the treadmill if the power cord or plug is damaged, or if the treadmill is not working properly. (See BEFORE YOU BEGIN on page 4 if the treadmill is not working properly.)
13. Never start the treadmill while you are standing on the walking belt. Always hold the handrails while using the treadmill.
14. The treadmill is capable of high speeds. Adjust the speed in small increments to avoid sudden jumps in speed.

15. Do not use the hand weights at speeds higher than a walk. Using hand weights and not holding the handrails may compromise your ability to maintain your balance. Exercises using hand weights should be attempted only by experienced users.

16. The pulse sensor is not a medical device. Various factors, including the user's movement, may affect the accuracy of heart rate readings. The pulse sensor is intended only as an exercise aid in determining heart rate trends in general.

17. Never leave the treadmill unattended while it is running. Always remove the key, unplug the power cord and move the on/off switch to the off position when the treadmill is not in use. (See the drawing on page 4 for the location of the on/off switch.)

18. Do not attempt to raise, lower, or move the treadmill until it is properly assembled. (See ASSEMBLY on page 5, and HOW TO MOVE THE TREADMILL on page 23.) You must be able to safely lift 45 pounds (20 kg) in order

to raise, lower, or move the treadmill.

19. When folding or moving the treadmill, make sure that the storage latch is fully closed.

20. Inspect and tighten all parts of the treadmill every three months.

21. Never drop or insert an object into any opening.

22. The treadmill is intended for in-home use only. Do not use the treadmill in any commercial, rental, or institutional setting.

23. **DANGER:** Always unplug the power cord immediately after use, before cleaning the treadmill, and before performing the maintenance and adjustment procedures described in this manual. Never remove the motor hood unless instructed to do so by an authorized service representative. Servicing other than the procedures in this manual should be performed by an authorized service representative only.

**⚠ WARNING:** Before beginning this or any exercise program, consult your physician. This is especially important for persons over the age of 35 or persons with pre-existing health problems. Read all instructions before using. ICON assumes no responsibility for personal injury or property damage sustained by or through the use of this product.

## SAVE THESE INSTRUCTIONS

The decals shown below have been placed on your treadmill. If a decal is missing or illegible, please call our Customer Service Department toll-free at 1-800-999-3756 to order a free replacement decal. Apply the decal in the location shown. Note: The large decal is shown at 38% of actual size.

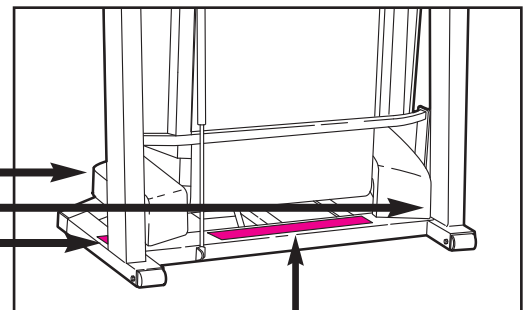

### ⚠ WARNING:

Protect yourself and others from risk of serious injury. Read the user's manual and:

- Fully engage storage latch before treadmill is moved or stored.
- Reduce incline to lowest level before folding treadmill into storage position.



- Stand only on side rails when starting or stopping treadmill.
- Change speed in small increments.
- Hold handrails to prevent falling, and always wear the safety clip while operating treadmill.
- Stop if you feel faint, dizzy, or short of breath.



- Never allow children on or around treadmill.
- Remove key when not in use.



- Keep clothing, fingers, and hair away from moving belt.
- Never try to adjust or fix the belt while it is moving.
- Always wear athletic shoes while operating treadmill.

# BEFORE YOU BEGIN

Congratulations for purchasing the HealthRider® SOFT-STRIDER S700xi™ treadmill. The SOFTSTRIDER S700xi offers an impressive array of features to help you achieve your fitness goals in the convenience of your home. From the advanced console to the cushioned walking belt, the SOFTSTRIDER S700xi is designed to make each workout more effective and enjoyable. And when you're not exercising, the SOFTSTRIDER S700xi can be folded away, taking less than half the floor space of conventional treadmills.

**For your benefit, read this manual carefully before using the treadmill.** If you have additional questions,

please call our Customer Service Department toll-free at 1-800-999-3756, Monday through Friday, 6 a.m. until 6 p.m. Mountain Time (excluding holidays). To help us assist you, please note the product model number and serial number before calling. The model number is HRTL16900. The serial number can be found on a decal attached to the treadmill (see the front cover of this manual for the location).

Before reading further, please familiarize yourself with the parts that are labeled in the drawing below.

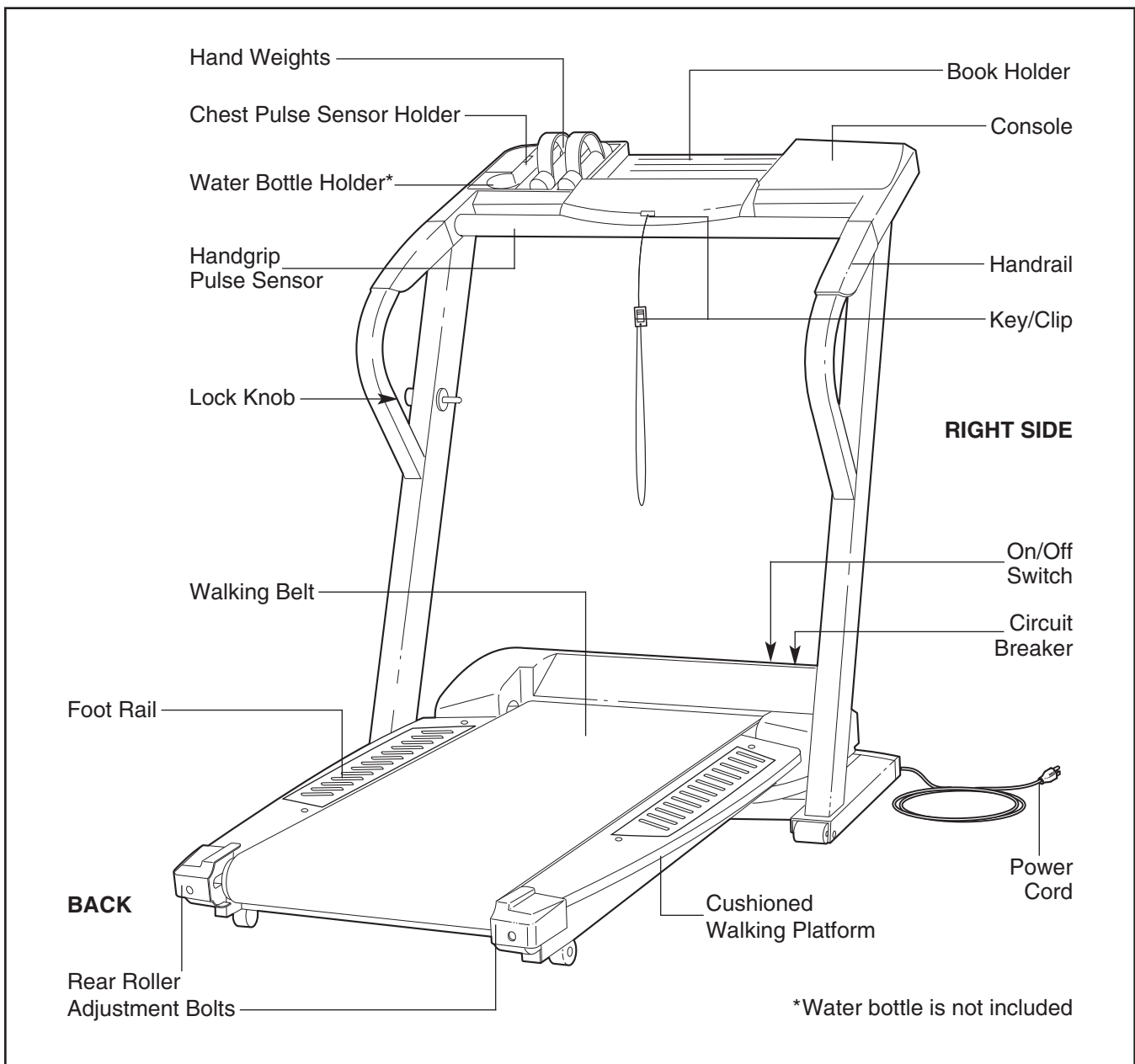

# ASSEMBLY

**Assembly requires two people.** Place the treadmill in a cleared area and remove all packing materials. Do not dispose of the packing materials until the treadmill is assembled. **No tools are required.**

Note: The underside of the treadmill walking belt is coated with high-performance lubricant. During shipping, a small amount of lubricant may be transferred to the top of the walking belt, the sides of the walking platform, or the shipping carton. This does not affect treadmill performance. If there is lubricant on top of the walking belt or on the sides of the walking platform, wipe off the lubricant with a soft cloth and a mild, non-abrasive cleaner.

1. **With the help of a second person,** carefully raise the Uprights (103) until the Wheels (99) are resting on the floor as shown.

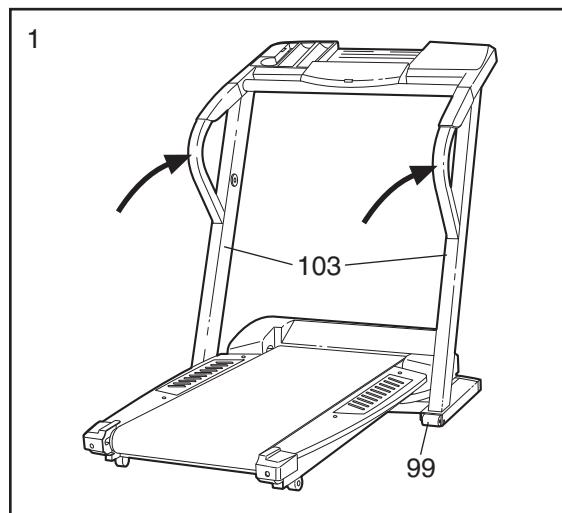

2. Next, make sure that the Lock Knob Sleeve (68) is fully inserted into the left Upright (103).

Remove the Lock Knob (67) from the Lock Pin (72). Make sure that the Lock Pin Collar (70) and the Spring (69) are on the Lock Pin. (Note: If there are two Lock Pin Collars, place them on each side of the Spring.) Insert the Lock Pin into the left Upright (103) and tighten the Lock Knob onto it.

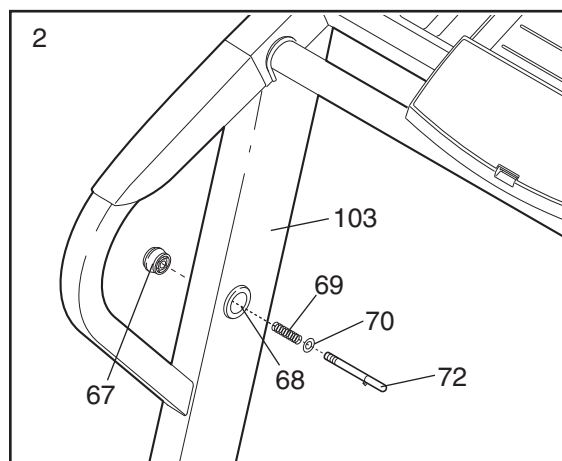

3. **Make sure that all parts are tightened before you use the treadmill. Place a mat beneath the treadmill to protect the floor or carpet.** For your benefit, we recommend that you familiarize yourself with the TROUBLE-SHOOTING AND MAINTENANCE section on pages 25 through 27.

# HOW TO USE THE CHEST PULSE SENSOR

## HOW TO PUT ON THE CHEST PULSE SENSOR

The chest pulse sensor consists of two components: the chest strap and the sensor unit (see the drawing below). Insert the tab on one end of the chest strap into one end of the sensor unit, as shown in the inset drawing. Press the end of the sensor unit under the buckle on the chest strap. The tab should be flush with the front of the sensor unit.

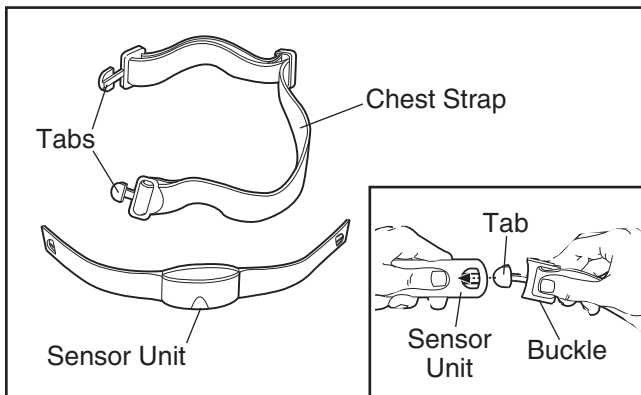

Next, wrap the chest pulse sensor around your chest and attach the other end of the chest strap to the sensor unit. Adjust the length of the chest strap, if necessary. The chest pulse sensor should be under your clothing, tight against your skin, and as high under the pectoral muscles or breasts as is comfortable. Make sure that the logo on the sensor unit is facing forward and is right-side-up.

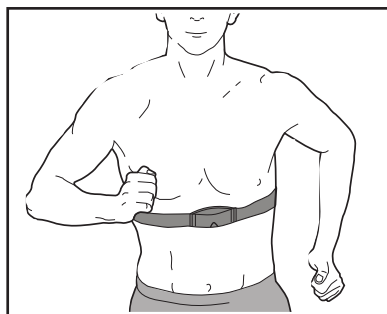

Pull the sensor unit away from your body a few inches and locate the two electrode areas on the inner side. The electrode areas are the areas covered by shallow ridges. Using saline solution such as saliva or contact lens solution, wet both electrode areas. Return the sensor unit to a position against your chest.

## CHEST PULSE SENSOR CARE AND MAINTENANCE

- Thoroughly dry the chest pulse sensor after each use. The chest pulse sensor is activated when the electrode areas are wetted and the heart rate monitor is put on; the chest pulse sensor shuts off when it is removed and the electrode areas are dried. If the chest pulse sensor is not dried after

each use, it may remain activated longer than necessary, draining the battery prematurely.

- Store the chest pulse sensor in a warm, dry place. Do not store the chest pulse sensor in a plastic bag or other container that may trap moisture.
- Do not expose the chest pulse sensor to direct sunlight for extended periods of time; do not expose it to temperatures above 122° Fahrenheit (50° Celsius) or below 14° Fahrenheit (-10° Celsius).
- Do not excessively bend or stretch the sensor unit when using or storing the chest pulse sensor.
- Clean the sensor unit using a damp cloth—never use alcohol, abrasives, or chemicals. The chest strap may be hand washed and air dried.

## CHEST PULSE SENSOR TROUBLE-SHOOTING

The instructions on the following pages explain how the chest pulse sensor is used with the console. If the chest pulse sensor does not function properly, try the steps below.

- Make sure that the chest pulse sensor is under your clothing, tight against your skin, and as high under the pectoral muscles or breasts as is comfortable. The logo on the sensor unit must be facing forward and be right-side-up. Note: If the chest pulse sensor does not function when positioned as described, try moving it slightly lower or higher on your chest.
- Use saline solution such as saliva or contact lens solution to wet the two electrode areas on the sensor unit. If heart rate readings do not appear until you begin perspiring, re-wet the electrode areas.
- As you walk or run on the treadmill, position yourself near the center of the walking belt. **For the console to display heart rate readings, the user must be within arm's length of the console.**
- The chest pulse sensor is designed to work with people who have normal heart rhythms. Heart rate reading problems may be caused by medical conditions such as premature ventricular contractions (pvc's), tachycardia bursts, and arrhythmia.
- The operation of the chest pulse sensor can be affected by magnetic interference caused by high power lines or other sources. If it is suspected that this is a problem, try relocating the treadmill.
- The CR2032 battery may need to be replaced (see page 27).



# OPERATION AND ADJUSTMENT

## THE PERFORMANT LUBE™ WALKING BELT

Your treadmill features a walking belt coated with PERFORMANT LUBE™, a high-performance lubricant.

**IMPORTANT: Never apply silicone spray or other substances to the walking belt or the walking platform. Such substances will deteriorate the walking belt and cause excessive wear.**

## HOW TO PLUG IN THE POWER CORD

**⚠ DANGER:** Improper connection of the equipment-grounding conductor can result in an increased risk of electric shock. Check with a qualified electrician or serviceman if you are in doubt as to whether the product is properly grounded. Do not modify the plug provided with the product—if it will not fit the outlet, have a proper outlet installed by a qualified electrician.

Your treadmill, like any other type of sophisticated electronic equipment, can be seriously damaged by sudden voltage changes in your home's power. Voltage surges, spikes, and noise interference can result from weather conditions or from other appliances being turned on or off. **To decrease the possibility of your treadmill being damaged, always use a surge suppressor with your treadmill (see drawing 1 at the right).**

**To purchase a surge suppressor, see your local HEALTHRIDER dealer or call 1-800-999-3756 and order part number 146148.** Use only a single-outlet surge suppressor that is UL 1449 listed as a transient voltage surge suppressor (TVSS). The surge suppressor must have a UL suppressed voltage rating of 400 volts or less and a minimum surge dissipation of 450 joules. The surge suppressor must be electrically rated for 120 volts AC and 15 amps.

**This product must be grounded.** If it should malfunction or break down, grounding provides a path of least resistance for electric current to reduce the risk of electric shock. This product is equipped with a cord having an equipment-grounding conductor and a grounding plug. **Plug the power cord into a surge suppressor, and plug the surge suppressor into an appropriate outlet that is properly installed and grounded in accordance with all local codes and ordinances. Important: The treadmill is not compatible with GFCI-equipped outlets.**

This product is for use on a nominal 120-volt circuit, and has a grounding plug that looks like the plug illustrated in drawing 1 below. A temporary adapter that looks like the adapter illustrated in drawing 2 may be used to connect the surge suppressor to a 2-pole receptacle as shown in drawing 2 if a properly grounded outlet is not available.

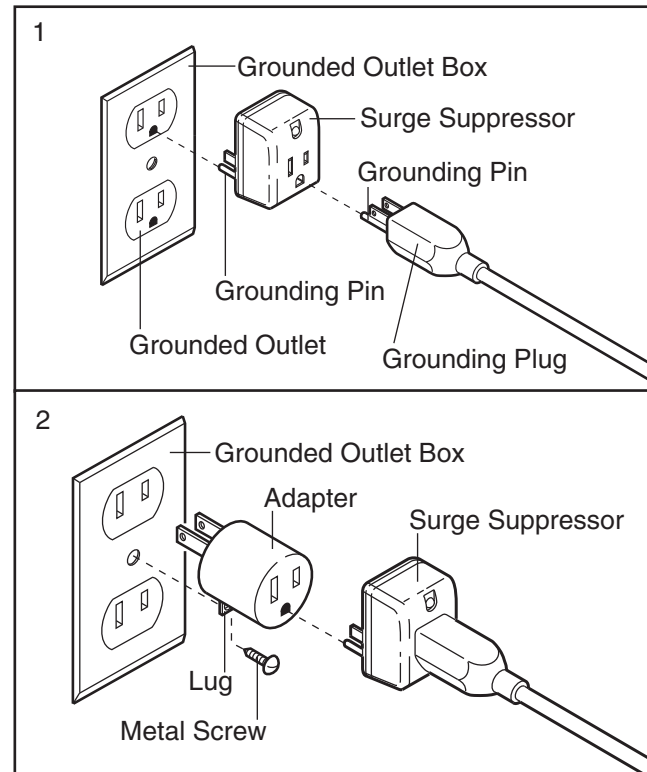

The temporary adapter should be used only until a properly grounded outlet (drawing 1) can be installed by a qualified electrician.

The green-colored rigid ear, lug, or the like extending from the adapter must be connected to a permanent ground such as a properly grounded outlet box cover. Whenever the adapter is used it must be held in place by a metal screw. **Some 2-pole receptacle outlet box covers are not grounded. Contact a qualified electrician to determine if the outlet box cover is grounded before using an adapter.**

## DIAGRAM OF THE CONSOLE

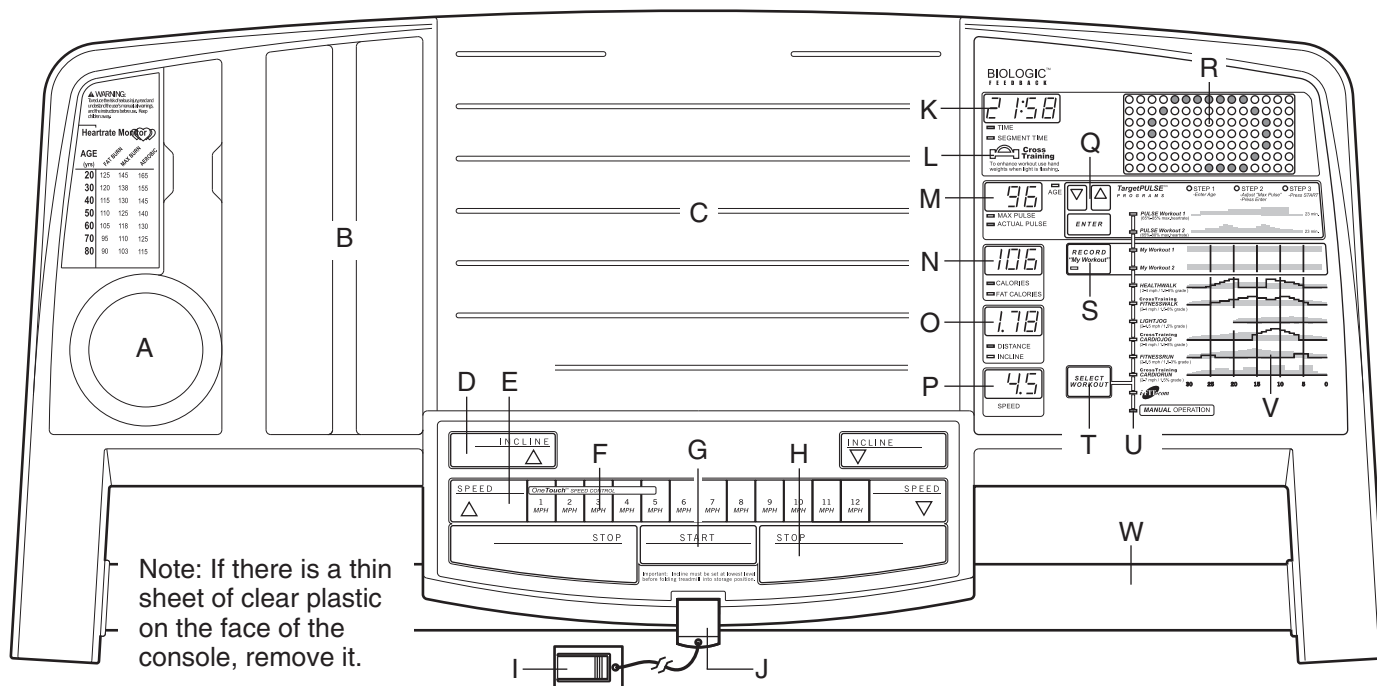

## FEATURES OF THE CONSOLE

The treadmill console offers an impressive selection of features to help you get the most from your exercise.

When the console is in the manual mode, the speed and incline of the treadmill can be changed with a touch of a button. As you exercise, the displays will show your workout time, the number of calories and fat calories you have burned, the distance you have walked, the incline level of the treadmill, and the speed of the walking belt. If you use the built-in handgrip pulse sensor or chest pulse sensor, the console will also show your heart rate.

The console also offers six preset workout programs. Each program automatically controls the speed and incline of the treadmill as it guides you through an effective workout. The included hand weights allow you to add upper body exercise to your workout as well. Two pulse programs are also offered. Each program automatically adjusts the speed and incline of the treadmill to keep your heart rate within a preset range during your workout.

The console even allows you to create your own workout programs and store them in memory for future use.

The console also features advanced iFIT.com technology. iFIT.com technology is like having a personal trainer right in your home. Using the included audio cable, you can connect the treadmill to your home stereo, portable stereo, or computer and play special

iFIT.com CD programs (CD's are available separately). iFIT.com CD programs automatically control the speed and incline of the treadmill as a personal trainer guides you through every step of your workout. High-energy music provides added motivation. Each CD features two programs designed by certified personal trainers.

In addition, you can connect the treadmill to your VCR and TV and play iFIT.com video programs (videocassettes are available separately). Video programs offer the same benefits as iFIT.com CD programs, but add the excitement of working out with a class and an instructor—the hottest new trend at health clubs.

With the treadmill connected to your computer, you can also go to our new internet site at [www.iFIT.com](http://www.iFIT.com) and access basic programs, audio programs, and video programs directly from the internet. And by adding an optional upgrade module to the treadmill, you can use virtually endless features from our internet site. See [www.iFIT.com](http://www.iFIT.com) for complete details.

To purchase iFIT.com CD's or videocassettes or an optional upgrade module, call toll-free 1-800-735-0768.

**To use the manual mode of the console**, follow the steps beginning on page 10. **To use a preset program**, see page 12. **To use a pulse program**, see page 13. **To create and use a custom program**, see pages 15 and 16. **To use an iFIT.com CD or video program**, see page 19. **To use an iFIT.com program directly from our internet site**, see page 21.



## DESCRIPTION OF THE CONSOLE

Refer to the drawing on page 8 to identify the features described below.

- A. Water bottle holder—This convenient holder keeps your water bottle handy during your workouts (no water bottle is included).
- B. Hand weight holder—These compartments hold the included hand weights.
- C. Book holder—This area is designed to hold your favorite magazine or the latest best-seller.
- D. Incline buttons—These buttons control the incline of the treadmill. Each time a button is pressed, the incline will change by 0.5%. The incline range is 0% to 10%.
- E. Speed buttons—These buttons control the speed of the walking belt. Each time a button is pressed, the speed will change by 0.1 mph; if a button is held down, the speed will change in increments of 0.5 mph. The speed range is 0.5 mph to 12 mph.
- F. Quick Speed buttons—These buttons allow you to quickly select speed settings.
- G. Start button—This button is used to start the walking belt.
- H. Stop buttons—These buttons are used to stop the walking belt. Note: Pressing either button will stop the walking belt.
- I. Waistband clip—This clip is designed to be worn on the waistband of your clothes. If the key is pulled from the console, the walking belt will automatically stop.
- J. Key—This key turns the console on and off.
- K. Time/Segment Time display—When the manual mode or an iFIT.com program is selected, this display will show the elapsed time. When a preset program, a pulse program, or a custom program is selected, the display will show both the time remaining in the program and the time remaining in the current segment of the program. The display will alternate between one number and the other every seven seconds.
- L. Cross Training indicator—During the Fitnesswalk, Cardiojog, or Cardiorun programs, this indicator will periodically flash. The included hand weights can be used while the indicator is flashing to add upper body exercise to your workouts.
- M. Pulse display—This display shows your heart rate when the handgrip pulse sensor or the chest pulse sensor is used.
- N. Calories display—This display shows the approximate numbers of calories and fat calories you have burned. The display will alternate between one number and the other every seven seconds.
- O. Distance/Incline display—This display shows the distance you have walked and the incline level of the treadmill. The display will alternate between one number and the other every seven seconds. Note: Each time the Incline buttons are pressed, the display will change to show the incline setting.
- P. Speed display—This display shows the speed of the walking belt.
- Q. Enter button and  $\Delta$  and  $\nabla$  buttons—These buttons are used to enter your age when pulse programs are used.
- R. Program display—When the manual mode or an iFIT.com program is selected, this display will show your progress on an LED track. When a preset program, a pulse program, or a custom program is selected, the display will show the settings for the program.
- S. Record button—This button is used to program speed and incline settings for custom programs.
- T. Select Workout button—This button is used to select the manual mode, the preset programs, the pulse programs, the custom programs, and iFIT.com programs. Note: If the walking belt is moving when the Select Workout button is pressed, the walking belt will slow to a stop, the displays will be reset, and a new program or the manual mode will be selected.
- U. Mode indicators—These indicators show whether the manual mode, a preset program, a pulse program, a custom program, or an iFIT.com program is selected.
- V. Program profiles—These profiles show how the speed and incline of the treadmill will change during preset programs, and how the target heart rate will change during pulse programs.
- W. Handgrip pulse sensor—The handgrip pulse sensor allows you to measure your heart rate before, during, or after your workouts.

**Note: The console can display exercise feedback in either miles or kilometers (see SPEED DISPLAY on page 11). For simplicity, all instructions in this section refer to miles.**

**⚠ WARNING:** To reduce the risk of serious injury, read the following precautions before operating the console.

- Do not stand on the walking belt when turning on the power or starting the walking belt.
- Always attach the clip (see “I” on page 8) to your waistband when using the treadmill. If the key is pulled from the console, the walking belt will stop.
- The treadmill is capable of high speeds. Adjust the speed in small increments.
- To reduce the risk of electric shock, keep liquids away from the console and place only a sealed water bottle in the console.
- Using hand weights and not holding the handrails may compromise your ability to maintain your balance. Exercises using hand weights should be attempted only by experienced users.
- If you have heart problems, or if you are over 60 years of age and have been inactive, do not use the pulse programs. If you are taking medication regularly, consult your physician to find whether the medication will affect your exercise heart rate.

## HOW TO TURN ON THE POWER

**1** Plug in the power cord (see HOW TO PLUG IN THE POWER CORD on page 7).

**2** Locate the on/off switch on the front of the treadmill near the power cord. Move the on/off switch to the on position.

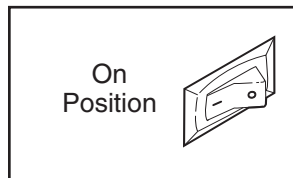

**3** Stand on the foot rails of the treadmill. Find the clip attached to the key and slide the clip fully onto the waistband of your clothing. Next, insert the key into the console. After a moment, the displays, the LED track, and various indicators will light.

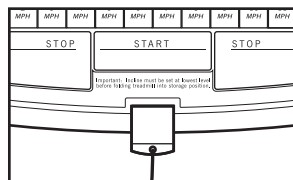

## HOW TO USE THE MANUAL MODE

**1** Insert the key into the console.

See HOW TO TURN ON THE POWER at the left.

**2** Select the manual mode.

When the key is inserted, the manual mode will be selected and the manual indicator will light. If a program is selected, press the Select Workout button repeatedly to select the manual mode.

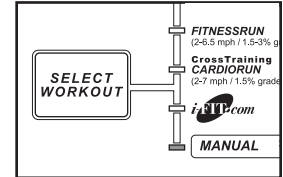

**3** Press the Start button or the Speed  $\Delta$  button to start the walking belt.

A moment after the button is pressed, the walking belt will begin to move at 1.0 mph. Hold the handrails and begin walking.

As you exercise, adjust the speed of the walking belt as desired by pressing the Speed buttons or the Quick Speed buttons. Note: After the buttons are pressed, it may take a moment for the walking belt to reach the selected speed setting.

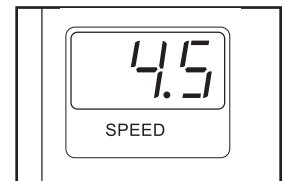

To stop the walking belt, press either of the Stop buttons. The displays will pause and the Time/Segment Time display will begin to flash. To restart the walking belt, press the Start button or the Speed  $\Delta$  button. To stop the walking belt and reset the displays, press a Stop button, remove the key, and then reinsert the key.

**4** Adjust the incline of the treadmill as desired.

To vary the intensity of your exercise, adjust the incline of the treadmill by pressing the Incline buttons. Note: After the buttons are pressed, it may take a moment for the treadmill to reach the selected incline setting.

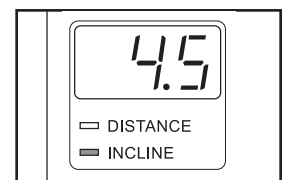

## 5 Follow your progress with the LED track and the five displays.

**LED Track**—When the manual mode or an iFIT.com program is selected, the program display will show a track representing a distance of 1/4 mile. As you exercise, the indicators around the track will light one at a time until the entire track is lit. A new lap will then begin.

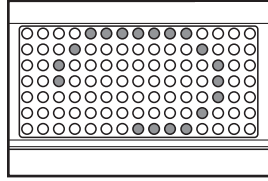

### Time/Segment Time display

—When the manual mode or an iFIT.com program is selected, this display will show the elapsed time. When a preset program, a pulse program, or a custom program is selected, the display will show both the time remaining in the program and the time remaining in the current segment of the program. The display will alternate between one number and the other every seven seconds. Note: For an explanation of the Cross Training indicator, see step 4 on page 13.

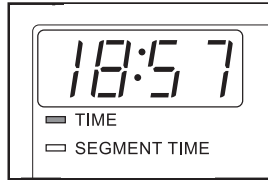

**Pulse display**—This display shows your heart rate when you use the handgrip pulse sensor (see step 6) or the chest pulse sensor (see page 6).

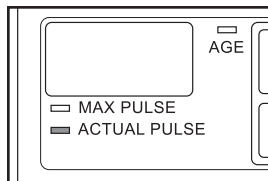

### Calories display

—This display shows the approximate numbers of calories and fat calories you have burned (see FAT BURNING on page 28). The display will alternate between one number and the other every seven seconds.



### Distance/Incline display

—This display shows the distance you have walked and the incline level of the treadmill. The display will alternate between one number and the other every seven seconds. Note: Each time the Incline buttons are pressed, the display will change to show the incline setting.

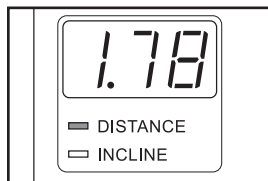

**Speed display**—This display shows the speed of the walking belt.

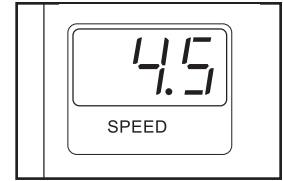

Note: The speed can be displayed in either miles per hour (mph) or kilometers per hour (kph). To see which unit of measurement is selected, hold down one of the Stop buttons while inserting the key into the console. The Speed display will show an “E” for English miles or an “M” for metric kilometers. Pressing the Speed  $\Delta$  button will change the unit of measurement. When the desired unit of measurement is selected, remove and reinsert the key.

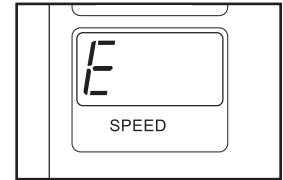

## 6 Use the handgrip pulse sensor, if desired.

If you are not wearing the chest pulse sensor and you want to measure your heart rate, **stand on the foot rails** and place your hands on the metal contacts on the handrail. Your palms must be resting on the upper contacts, and your fingers must be touching the lower contacts—**avoid moving your hands**. After a few seconds, one or two dashes will appear in the Pulse display and then your heart rate will be shown. **For the most accurate heart rate reading, hold the contacts for about 15 seconds.**

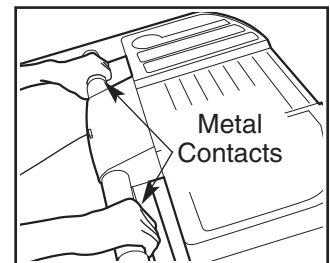

## 7 When you are finished exercising, stop the walking belt and remove the key.

Step onto the foot rails, press one of the Stop buttons, and adjust the incline of the treadmill to 0%. **The incline must be at 0% when the treadmill is raised to the storage position or the treadmill will be damaged.** Next, remove the key from the console and put it in a secure place. **Note: If the displays and indicators on the console remain lit after the key is removed, the console is in the “demo” mode. Refer to page 22 and turn off the demo mode.**

When you are finished using the treadmill, move the on/off switch near the power cord to the off position and unplug the power cord.

## HOW TO USE THE PRESET PROGRAMS

### 1 Insert the key into the console.

See HOW TO TURN ON THE POWER on page 10.

### 2 Select one of the six preset programs.

When the key is inserted, the manual mode will be selected and the manual indicator will light. To select one of the preset programs, press the Select Workout button repeatedly until one of the six preset program indicators lights.

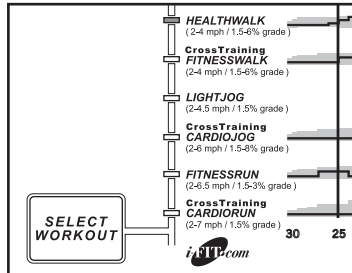

The profiles on the console show how the speed and incline of the treadmill will change during the preset programs—the white profiles show speed settings and the green lines show incline settings. The numbers at the left ends of the profiles show the speed and incline ranges for the programs. During the Healthwalk program, for example, the speed of the walking belt will vary from 2 mph to 4 mph and the incline will vary from 0% to 6%. The program display will show a simplified profile of the program. The Time/Segment Time display will show how long the selected program will last.

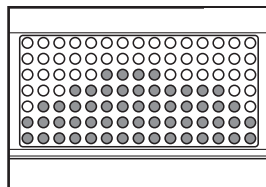

### 3 Press the Start button or the Speed $\Delta$ button to start the program.

A moment after the button is pressed, the treadmill will automatically adjust to the first speed and incline settings for the program. Hold the handrails and begin walking.

Each program is divided into several time segments of different lengths. The Time/Segment Time display shows both the time remaining in the program and the time remaining in the current segment. One speed setting and one incline setting are programmed for each segment. The speed setting for the first segment will be shown in

the flashing Current Segment column of the program display. (The incline settings are not shown in the program display.) The speed settings for the next twelve segments will be shown in the twelve columns to the right.

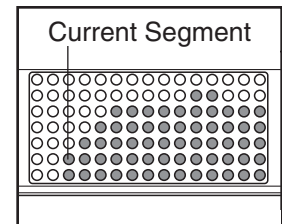

When only three seconds remain in the first segment of the program, both the Current Period column and the column to the right will flash, a series of tones will sound, and *all speed settings will move one column to the left*. The speed setting for the second segment will then be shown in the flashing Current Segment column and the treadmill will automatically adjust to the speed and incline settings for the second segment.

The program will continue in this way until the speed setting for the last segment is shown in the Current Segment column and no time remains in the Time/Segment Time display. The walking belt will then slow to a stop.

Note: Each time a segment ends and the speed settings move one column to the left, *if all of the indicators in the Current Segment column are lit, the speed settings will move downward so that only the highest indicators in the columns will appear in the program display*. When the speed settings move to the left again and not all of the indicators in the Current Segment column are lit, the speed settings will move back up.

If the speed or incline setting for the current segment is too high or too low, you can manually override the setting by pressing the Speed or Incline buttons on the console. Every few times one of the Speed buttons is pressed, an additional indicator will light or darken in the Current Segment column. If any of the columns to the right of the Current Segment column have the same number of lit indicators as the Current Period column, an additional indicator may light or darken in those columns as well. Note: If you *manually* adjust the speed setting so that all of the indicators in the Current Segment column are lit, the speed settings in the program display will *not* move downward as described above. **Note: When the current segment of the program ends, the treadmill will automatically adjust to the speed and incline settings for the next segment.**

To stop the program temporarily, press one of the Stop buttons. All displays will pause and the Time/Segment Time display will begin to flash. To restart the program, press the Start button or the Speed  $\Delta$  button. To end the program, press a Stop button, remove the key, and then reinsert the key.

#### 4 Use the hand weights, if desired.

If the Fitnesswalk, Cardiojog, or Cardiorun program is selected, the Cross Training Indicator in the Time/Segment Time display will periodically flash.

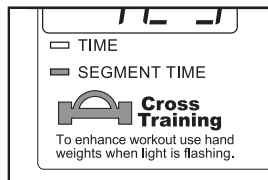

While the indicator is flashing, use the included hand weights for upper body exercise as you walk on the treadmill.

#### 5 Follow your progress with the displays.

Refer to step 5 on page 11.

#### 6 Use the handgrip pulse sensor, if desired.

Refer to step 6 on page 11.

#### 7 When the program has ended, remove the key.

Step onto the foot rails and make sure that the incline of the treadmill is at 0%. **The incline must be at 0% when the treadmill is raised to the storage position.** Next, remove the key from the console and put it in a secure place. **Note: If the displays and indicators on the console remain lit after the key is removed, the console is in the "demo" mode. Refer to page 22 and turn off the demo mode.**

When you are finished using the treadmill, move the on/off switch near the power cord to the off position and unplug the power cord.

## HOW TO USE THE PULSE PROGRAMS

### 1 Insert the key into the console.

See HOW TO TURN ON THE POWER on page 10.

### 2 Put on the chest pulse sensor.

You must wear the chest pulse sensor to use a pulse program. Follow the instructions on page 6 to put on the chest pulse sensor.

### 3 Select one of the two pulse programs.

When the key is inserted, the manual mode will be selected and the manual indicator will light. To select

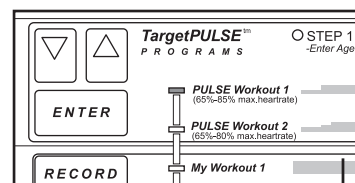

one of the pulse programs, press the Select Workout button repeatedly until one of the two pulse program indicators lights.

The profiles on the console show how the target heart rate will change during the programs. The program display will show a simplified profile of the program. The Time/Segment Time display will show how long the selected program will last.

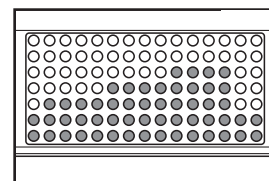

### 4 Enter your age.

When a pulse program is selected, an age setting will begin to flash in the Pulse display. If you have already

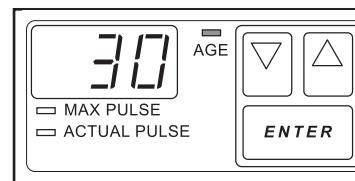

entered your age, simply press the Enter button. To enter your age, press the  $\Delta$  and  $\nabla$  buttons; the buttons can be held down to enter your age quickly. When your age is shown, press the Enter button.



## 5 Enter a maximum heart rate setting.

After you have entered your age, another number will begin to flash in the Pulse display. This number is the *maximum heart rate setting* for the program. If Pulse program 1 is selected, the maximum heart rate setting can be from 65% to 85% of your *maximum possible heart rate* (your maximum possible heart rate is 220 minus your age); if Pulse program 2 is selected, the maximum heart rate setting can be from 65% to 80% of your maximum possible heart rate. Note: Your maximum possible heart rate is an estimate only.

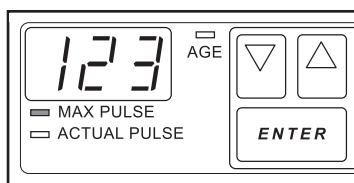

For example, if you are 30 years old, your maximum possible heart rate is 190 (220 minus 30 equals 190). Therefore, if Pulse program 1 is selected, the maximum heart rate setting can be from 123 to 161 (65% of 190 is 123; 85% of 190 is 161).

If you want to change the maximum heart rate setting, press the  $\Delta$  and  $\nabla$  buttons. The buttons can be held down to change the setting quickly. When the desired setting is shown, press the Enter button.

## 6 Press the Start button or the Speed $\Delta$ button to start the program.

A moment after the button is pressed, the treadmill will automatically adjust to the first speed and incline settings for the program. Hold the handrails and begin walking.

Each program is divided into several time segments of different lengths. The Time/Segment Time display will show both the time remaining in the program and the time remaining in the current segment. One target heart rate setting is programmed for each segment. The heart rate setting for the first segment will be shown in the flashing Current Segment column of the program display. The heart rate settings for the next twelve segments will be shown in the twelve columns to the right.

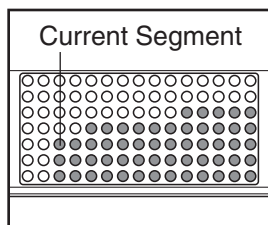

When only three seconds remain in the first segment of the program, both the Current Segment column and the column to the right will flash, a se-

ries of tones will sound, and *all heart rate settings will move one column to the left*. The heart rate setting for the second segment will then be shown in the flashing Current Segment column. As you exercise, the speed and/or incline of the treadmill will automatically change as needed to keep your heart rate near the current target heart rate setting.

The program will continue until no time remains in the Time/Segment Time display. The walking belt will then slow to a stop.

If the speed or incline setting for the current segment is too high or too low, you can adjust the setting with the Speed or Incline buttons. However, if you *decrease* the speed, the incline will automatically *increase*; if you *increase* the speed, the incline will *decrease*. If you *increase* the incline, the speed will *decrease*; if you *decrease* the incline, the speed will *increase*. *The treadmill will always attempt to keep your heart rate near the target heart rate setting for the current segment*. Note: When the incline reaches the lowest setting, the speed cannot be increased any further. When the incline reaches the highest setting, the speed cannot be decreased any further.

If your heart rate is not detected during the program, the speed and incline of the treadmill may automatically decrease until your heart rate is detected. If this occurs, refer to page 6.

To stop the program, press either of the Stop buttons. Pulse programs should not be stopped temporarily and then restarted. To use the pulse program again, reselect the program and start it at the beginning.

## 7 Follow your progress with the displays.

Refer to step 5 on page 11.

## 8 When the program has ended, remove the key.

Step onto the foot rails and make sure that the incline of the treadmill is at 0%. **The incline must be at 0% when the treadmill is raised to the storage position.** Next, remove the key from the console and put it in a secure place. **Note: If the displays and indicators on the console remain lit after the key is removed, the console is in the "demo" mode. Refer to page 22 and turn off the demo mode.**

When you are finished using the treadmill, move the on/off switch near the power cord to the off position and unplug the power cord.



## HOW TO CREATE CUSTOM PROGRAMS

### 1 Insert the key into the console.

See HOW TO TURN ON THE POWER on page 10.

### 2 Select one of the two custom programs.

When the key is inserted, the manual mode will be selected and the manual indicator will light. To select one of the custom programs, press the Select Workout button repeatedly until one of the two custom program indicators lights.

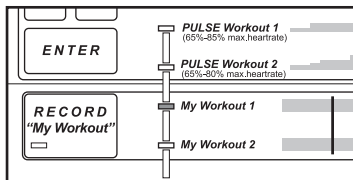

### 3 Press the Start button or the Speed $\Delta$ button to start the walking belt.

A moment after the button is pressed, the walking belt will begin to move. Hold the handrails and begin walking.

### 4 Press the Record button and program the desired speed and incline settings.

When the Record button is pressed, the indicator on the button will light. **Speed and incline settings can be programmed only when the indicator is lit.** Note: When the indicator on the Record button is lit, the Time/Segment Time display will show the elapsed time instead of the time remaining in the program.

Refer to the program display. Each custom program is divided into one-minute segments. One speed setting and one incline setting can be programmed for each segment. The speed setting for the first segment will be shown in the flashing Current Segment column of the program display. (The incline settings are not shown in the program display.) To program the desired speed and incline settings for the first segment, simply adjust the speed and incline of the

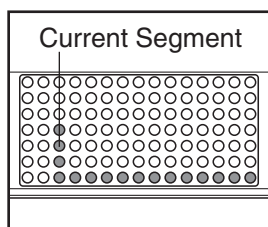

treadmill to the desired levels with the Speed and Incline buttons. Every few times one of the Speed buttons is pressed, an additional indicator will light or darken in the Current Segment column.

When the first segment of the program is completed, the current speed setting and the current incline setting will be stored in memory. All columns in the program display will then move one column to the left and the speed setting for the second segment will be shown in the flashing Current Segment column. Program speed and incline settings for the second segment as described above.

Repeat this procedure until you have programmed speed and incline settings for as many segments as desired—custom programs can have from one to forty segments. When you are finished, press the Select Workout button. The speed and incline settings that you programmed and the number of completed segments will be stored in memory.

To stop the program temporarily, press either of the Stop buttons. All displays will pause and the Time/Segment Time display will begin to flash. To restart the program, press the Start button or the Speed  $\Delta$  button.

### 5 Follow your progress with the displays.

Refer to step 5 on page 11.

### 6 Use the handgrip pulse sensor, if desired.

Refer to step 6 on page 11.

### 7 When the program has ended, remove the key.

Step onto the foot rails and make sure that the incline of the treadmill is at 0%. **The incline must be at 0% when the treadmill is raised to the storage position.** Next, remove the key from the console and put it in a secure place. **Note: If the displays and indicators on the console remain lit after the key is removed, the console is in the "demo" mode. Refer to page 22 and turn off the demo mode.**

When you are finished using the treadmill, move the on/off switch near the power cord to the off position and unplug the power cord.

## HOW TO USE CUSTOM PROGRAMS

### 1 Insert the key into the console.

See HOW TO TURN ON THE POWER on page 10.

### 2 Select one of the two custom programs.

When the key is inserted, the manual mode will be selected and the manual indicator will light. To select one of the custom programs, press the Select Workout button repeatedly until one of the two custom program indicators lights.

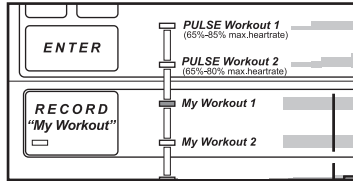

When a custom program is selected, the program display will show a simplified profile of the program. The Time/Segment Time display will show how long the selected program will last.

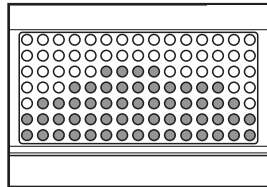

### 3 Press the Start button or the Speed $\Delta$ button to start the program.

A moment after the button is pressed, the treadmill will automatically adjust to the first speed and incline settings for the program. Hold the handrails and begin walking.

Each program is divided into several one-minute segments. The Time/Segment Time display shows both the time remaining in the program and the time remaining in the current segment. One speed setting and one incline setting are programmed for each segment. The speed setting for the first segment will be shown in the flashing Current Segment column of the program display. (The incline settings are not shown in the program display.) The speed settings for the next twelve segments will be shown in the twelve columns to the right.

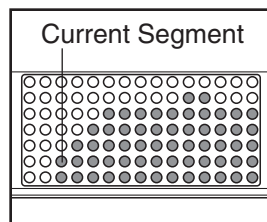

When only three seconds remain in the first segment of the program, both the Current Segment column and the column to the right will flash, a series of tones will sound, and *all speed settings will move one column to the left*. The speed setting for

the second segment will then be shown in the flashing Current Segment column and the treadmill will automatically adjust to the speed and incline settings that you programmed previously.

The program will continue until the speed setting for the last segment is shown in the Current Segment column and no time remains in the Time/Segment Time display. The walking belt will then slow to a stop.

If the program is too easy or too difficult, the speed or incline setting for the current segment can be adjusted with the Speed or Incline buttons. Adjustments will not be stored in memory. To **reprogram** the speed or incline setting for the current segment, press the Record button. The indicator on the button will light. **Speed and incline settings can be programmed only when the indicator is lit.** (Note: When the indicator on the Record button is lit, the Time/Segment Time display will show the elapsed time instead of the time remaining in the program.) Adjust the speed or incline setting for the current segment with the Speed or Incline buttons. *After the segment is completed*, press the Record button again. The new setting will be stored in memory.

To stop the program temporarily, press either of the Stop buttons. All displays will pause and the Time/Segment Time display will begin to flash. To restart the program, press the Start button or the Speed  $\Delta$  button. To end the program, press a Stop button, remove the key, and then reinsert the key.

### 4 Follow your progress with the displays.

Refer to step 5 on page 11.

### 5 Use the handgrip pulse sensor, if desired.

Refer to step 6 on page 11.

### 6 When the program has ended, remove the key.

Step onto the foot rails and make sure that the incline of the treadmill is at 0%. **The incline must be at 0% when the treadmill is raised to the storage position.** Next, remove the key from the console and put it in a secure place. **Note: If the displays and indicators on the console remain lit after the key is removed, the console is in the "demo" mode. Refer to page 22 and turn off the demo mode.**

When you are finished using the treadmill, move the on/off switch near the power cord to the off position and unplug the power cord.

## HOW TO CONNECT THE TREADMILL TO YOUR CD PLAYER, VCR, OR COMPUTER

To use **iFIT.com CD's**, the treadmill must be connected to your portable CD player, portable stereo, home stereo, or computer with CD player. See pages 17 and 18 for connecting instructions. To use **iFIT.com videocassettes**, the treadmill must be connected to your VCR. See page 19 for connecting instructions. To use **iFIT.com programs directly from our internet site**, the treadmill must be connected to your home computer. See page 18 for connecting instructions.

## HOW TO CONNECT YOUR PORTABLE CD PLAYER

**Note:** If your CD player has separate **LINE OUT** and **PHONES** jacks, see instruction A below. If your CD player has only one jack, see instruction B.

- A. Plug one end of the audio cable into the jack on the front of the treadmill near the power cord. Plug the other end of the cable into the **LINE OUT** jack on your CD player. Plug your headphones into the **PHONES** jack.

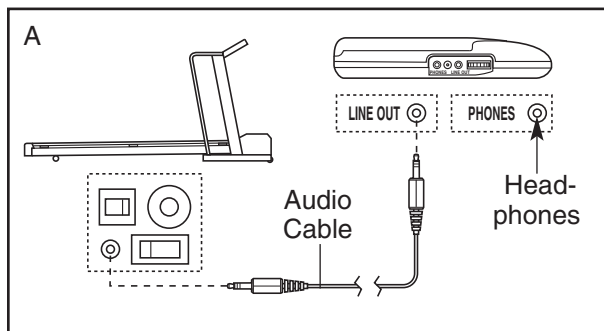

- B. Plug one end of the audio cable into the jack on the front of the treadmill near the power cord. Plug the other end of the cable into a 3.5mm Y-adaptor (available at electronics stores). Plug the Y-adaptor into the **PHONES** jack on your CD player. Plug your headphones into the other side of the Y-adaptor.

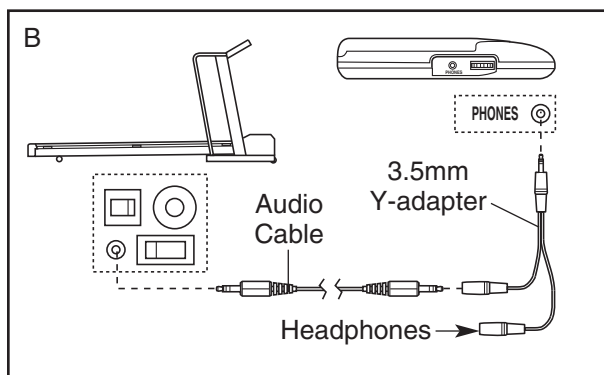

## HOW TO CONNECT YOUR PORTABLE STEREO

**Note:** If your stereo has an **RCA-type AUDIO OUT** jack, see instruction A below. If your stereo has a **3.5mm LINE OUT** jack, see instruction B. If your stereo has only a **PHONES** jack, see instruction C.

- A. Plug one end of the audio cable into the jack on the front of the treadmill near the power cord. Plug the other end of the cable into the included adaptor. Plug the adaptor into an **AUDIO OUT** jack on your stereo.

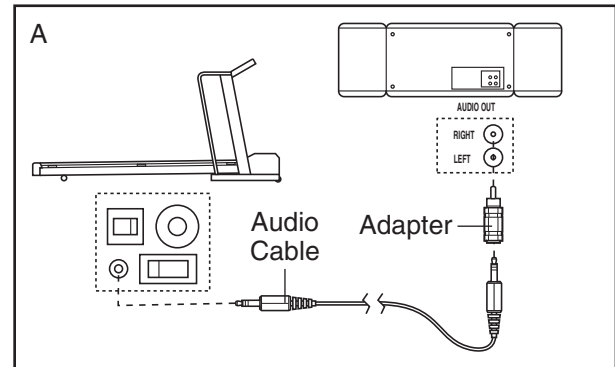

- B. Plug one end of the audio cable into the jack on the front of the treadmill near the power cord. Plug the other end of the cable into the **LINE OUT** jack on your stereo.

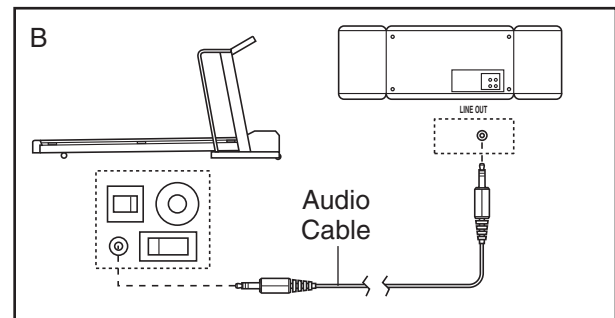

- C. Plug one end of the audio cable into the jack on the front of the treadmill near the power cord. Plug the other end of the cable into a 3.5mm Y-adaptor (available at electronics stores). Plug the Y-adaptor into the **PHONES** jack on your stereo. Plug your headphones into the other side of the Y-adaptor.

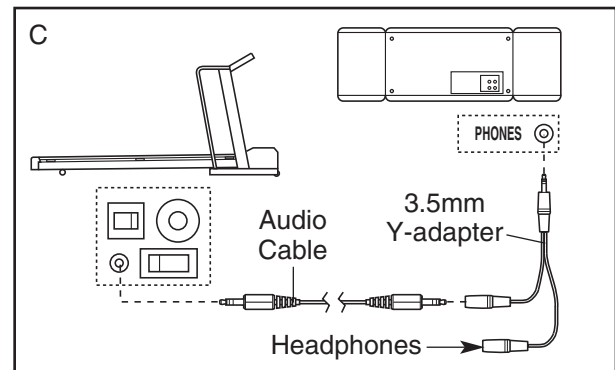

## HOW TO CONNECT YOUR HOME STEREO

**Note:** If your stereo has an unused **LINE OUT** jack, see instruction **A** below. If the **LINE OUT** jack is being used, see instruction **B**.

- A. Plug one end of the audio cable into the jack on the front of the treadmill near the power cord. Plug the other end of the cable into the included adapter. Plug the adapter into the **LINE OUT** jack on your stereo.

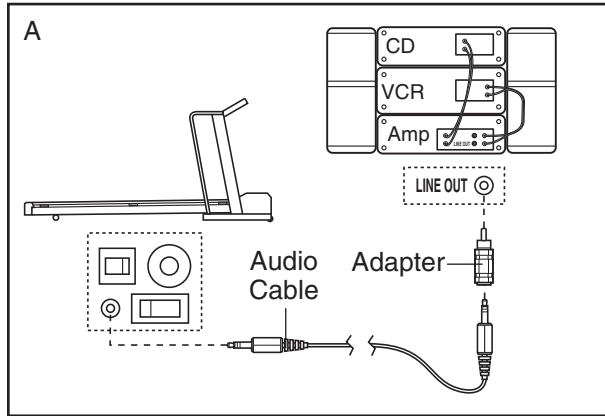

- B. Plug one end of the audio cable into the jack on the front of the treadmill near the power cord. Plug the other end of the cable into the included adapter. Plug the adapter into an **RCA adapter** (available at electronics stores). Next, remove the wire that is currently plugged into the **LINE OUT** jack on your stereo and plug the wire into the unused side of the **RCA adapter**. Plug the **RCA adapter** into the **LINE OUT** jack on your stereo.

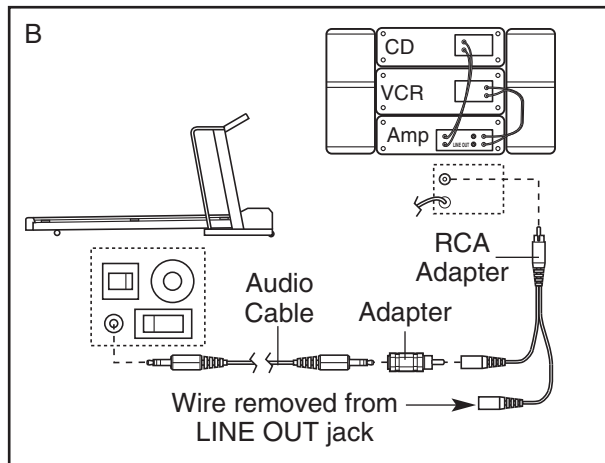

## HOW TO CONNECT YOUR COMPUTER

**Note:** If your computer has a **3.5mm LINE OUT** jack, see instruction **A**. If your computer has only a **PHONES** jack, see instruction **B**.

- A. Plug one end of the audio cable into the jack on the front of the treadmill near the power cord. Plug the other end of the cable into the **LINE OUT** jack on your computer.

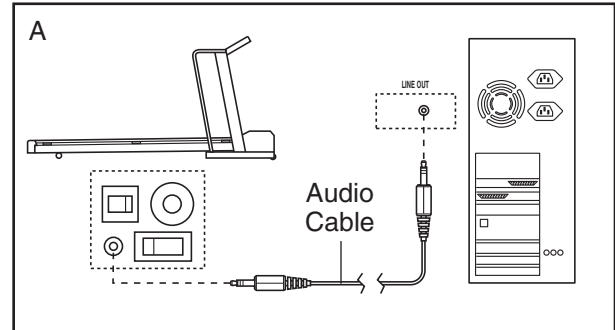

- B. Plug one end of the audio cable into the jack on the front of the treadmill near the power cord. Plug the other end of the cable into a **3.5mm Y-adapter** (available at electronics stores). Plug the **Y-adapter** into the **PHONES** jack on your computer. Plug your headphones or speakers into the other side of the **Y-adapter**.

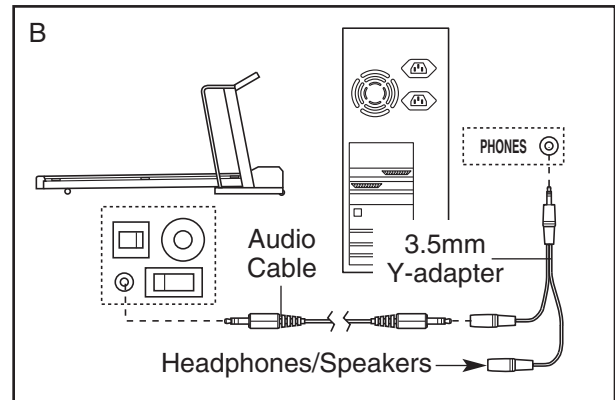

## HOW TO CONNECT YOUR VCR

**Note:** If your VCR has an unused AUDIO OUT jack, see instruction A below. If the AUDIO OUT jack is being used, see instruction B. If you have a TV with a built-in VCR, see instruction B. If your VCR is connected to your home stereo, see **HOW TO CONNECT YOUR HOME STEREO** on page 18.

- A. Plug one end of the audio cable into the jack on the front of the treadmill near the power cord. Plug the other end of the cable into the included adapter. Plug the adapter into the AUDIO OUT jack on your VCR.

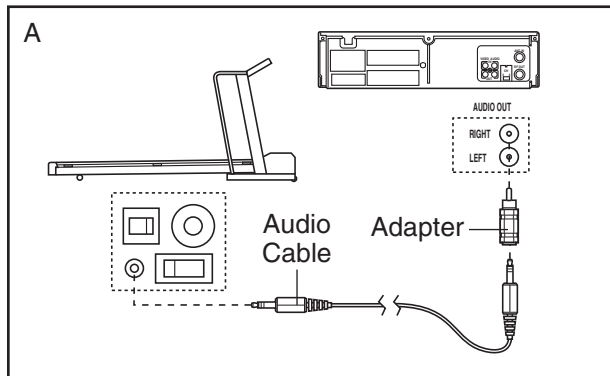

- B. Plug one end of the audio cable into the jack on the front of the treadmill near the power cord. Plug the other end of the cable into the included adapter. Plug the adapter into an RCA adapter (available at electronics stores). Next, remove the wire that is currently plugged into the AUDIO OUT jack on your VCR and plug the wire into the unused side of the RCA adapter. Plug the RCA adapter into the AUDIO OUT jack on your VCR.

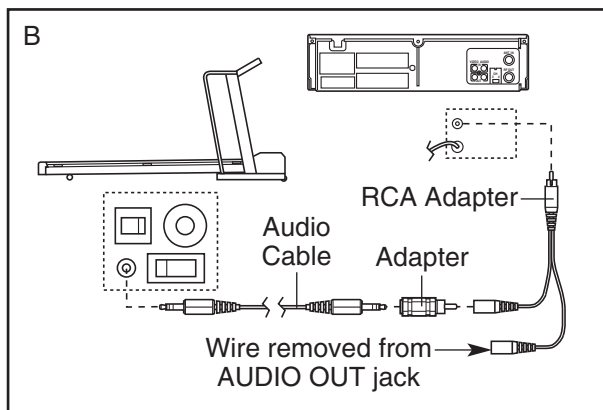

## HOW TO USE iFIT.COM CD AND VIDEO PROGRAMS

To use iFIT.com CD's or videocassettes, the treadmill must be connected to your portable CD player, portable stereo, home stereo, computer with CD player, or VCR. See **HOW TO CONNECT THE TREADMILL TO YOUR CD PLAYER, VCR, OR COMPUTER** on page 17. **Note:** To purchase iFIT.com CD's or iFIT.com videocassettes, call toll-free 1-800-735-0768.

Follow the steps below to use an iFIT.com CD or video program.

### 1 Insert the key into the console.

See **HOW TO TURN ON THE POWER** on page 10.

### 2 Select the iFIT.com mode.

When the key is inserted, the manual mode will be selected and the manual indicator will light. To use iFIT.com CD's or videocassettes, press the Select Workout button repeatedly until the iFIT.com indicator lights.

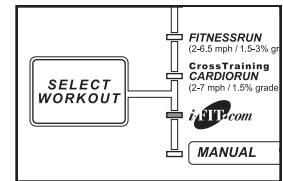

### 3 Insert the iFIT.com CD or videocassette.

If you are using an iFIT.com CD, insert the CD into your CD player. If you are using an iFIT.com videocassette, insert the videocassette into your VCR.

### 4 Press the PLAY button on your CD player or VCR.

A moment after the button is pressed, your personal trainer will begin guiding you through your workout. Simply follow your personal trainer's instructions. Note: If the Time/Segment Time display is flashing, press the Start button or the Speed  $\Delta$  button on the console. The treadmill will not respond to a CD or video program when the Time/Segment Time display is flashing.

During the CD or video program, an electronic "chirping" sound will alert you when the speed and/or incline of the treadmill is about to change. **CAUTION: Always listen for the "chirp" and be prepared for speed and/or incline changes. In some instances, the speed and/or incline may change before the personal trainer describes the change.**



If the speed or incline settings are too high or too low, you can manually override the settings at any time by pressing the Speed or Incline buttons on the console. However, **when the next “chirp” is heard, the speed and/or incline will change to the next settings of the CD or video program.**

To stop the walking belt at any time, press either of the Stop buttons on the console. The Time/Segment Time display will begin to flash. To restart the program, press the Start button or the Speed  $\Delta$  button. After a moment, the walking belt will begin to move at 1.0 mph. **When the next “chirp” is heard, the speed and incline will change to the next settings of the CD or video program.** The program can also be stopped by pressing the Stop button on your CD player or VCR.

When the CD or video program is completed, the walking belt will stop and the Time/Segment Time display will begin to flash. Note: To use another CD or video program, press a Stop button or remove the key and go to step 1 on page 19.

**Note: If the speed or incline of the treadmill does not change when a “chirp” is heard:**

- **make sure that the iFIT.com indicator is lit and that the Time/Segment Time display is not flashing. If the Time/Segment Time display is flashing, press the Start button or the Speed  $\Delta$  button on the console**
- **adjust the volume of your CD player or VCR. If the volume is too high or too low, the console may not detect the program signals**
- **make sure that the audio cable is properly connected, that it is fully plugged in, and that it is not wrapped around a power cord**
- **if you are using your portable CD player and the CD skips, set the CD player on the floor or another flat surface instead of on the console.**

## **5 Follow your progress with the displays.**

See step 5 on page 11.

## **6 Use the handgrip pulse sensor, if desired.**

Refer to step 6 on page 11.

## **7 When the program is completed, remove the key.**

Step onto the foot rails and make sure that the incline of the treadmill is at 0%. **The incline must be at 0% when the treadmill is raised to the storage position.** Next, remove the key from the console and put it in a secure place. **Note: If the displays and indicators on the console remain lit after the key is removed, the console is in the “demo” mode. Refer to page 22 and turn off the demo mode.**

When you are finished using the treadmill, move the on/off switch near the power cord to the off position and unplug the power cord.



## HOW TO USE PROGRAMS DIRECTLY FROM OUR INTERNET SITE

Our new internet site at [www.iFIT.com](http://www.iFIT.com) allows you to access a selection of programs that interactively control your treadmill to help you achieve your specific exercise goals. In addition, you can play iFIT.com audio and video programs directly from the internet. By adding an optional upgrade module to the console, you can use virtually endless features on our internet site. Explore [www.iFIT.com](http://www.iFIT.com) for details. To purchase an upgrade module, call toll-free 1-800-735-0768.

To use programs from our internet site, the treadmill must be connected to your home computer. See HOW TO CONNECT YOUR COMPUTER on page 18. In addition, you must have an internet connection and an internet service provider. A list of specific system requirements will be found on our internet site.

Follow the steps below to use a program from our internet site.

### 1 Insert the key into the console.

See HOW TO TURN ON THE POWER on page 10.

### 2 Select the iFIT.com mode.

When the key is inserted, the manual mode will be selected and the manual indicator will light. To use a program from our internet site, press the Select Workout button repeatedly until the iFIT.com indicator lights.

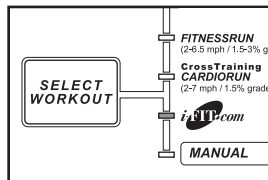

### 3 Go to your computer and start an internet connection.

### 4 Start your web browser, if necessary, and go to our internet site at [www.iFIT.com](http://www.iFIT.com).

### 5 Follow the desired links on our internet site to select a program.

Read and follow the on-line instructions for using a program.

### 6 Follow the on-line instructions to start the program.

When you start the program, an on-screen countdown will begin.

### 7 Return to the treadmill and stand on the foot rails. Find the clip attached to the key and slide the key onto the waistband of your clothing.

When the on-screen countdown ends, the program will begin and the walking belt will begin to move. Hold the handrails, step onto the walking belt, and begin walking. During the program, an electronic “chirping” sound will alert you when the speed and/or incline of the treadmill is about to change. **CAUTION: Always listen for the “chirp” and be prepared for speed and/or incline changes.**

If the speed or incline settings are too high or too low, you can manually override the settings at any time by pressing the Speed or Incline buttons on the console. **However, when the next “chirp” is heard, the speed and/or incline will change to the next settings of the program.**

To stop the walking belt at any time, press either of the Stop buttons on the console. The Time/Segment Time display will begin to flash. To restart the program, press the Start button or the Speed  $\Delta$  button. After a moment, the walking belt will begin to move at 1.0 mph. **When the next “chirp” is heard, the speed and incline will change to the next settings of the program.**

When the program is completed, the walking belt will stop and the Time/Segment Time display will begin to flash. Note: To use another program, press a Stop button and go to step 5.

**Note: If the speed or incline of the treadmill does not change when a “chirp” is heard, make sure that the iFIT.com indicator is lit and that the Time/Segment Time display is not flashing. In addition, make sure that the audio cable is properly connected, that it is fully plugged in, and that it is not wrapped around a power cord.**

### 8 Follow your progress with the displays.

See step 5 on page 11.

### 9 When the program has ended, remove the key.

Step onto the foot rails and make sure that the incline of the treadmill is at 0%. Remove the key from the console and put it in a secure place.

**Note: If the displays and indicators on the console remain lit after the key is removed, the console is in the “demo” mode. Refer to page 22 and turn off the demo mode.**

Next, move the on/off switch near the power cord to the off position and unplug the power cord.

## THE INFORMATION MODE/DEMO MODE

The console features an information mode that keeps track of the total number of hours that the treadmill has been operated and the total number of miles that the walking belt has moved. The information mode also allows you to switch the console from miles per hour to kilometers per hour. In addition, the information mode allows you to turn on and turn off the demo mode.

To select the information mode, hold down either of the Stop buttons while inserting the key into the console. When the information mode is selected, the following information will be shown:

The Time/Segment Time display will show the total number of hours that the treadmill has been used.

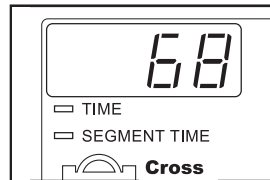

The Distance/Incline display will show the total number of miles that the walking belt has moved.

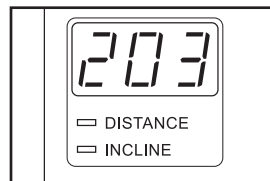

An “E,” for English miles, or an “M,” for metric kilometers, will appear in the Speed display. Press the Speed  $\Delta$  button to change the unit of measurement.

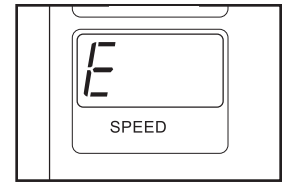

**IMPORTANT: The Calories display should be blank.** If a “d” appears in the display, the console is in the “demo” mode. This mode is intended to be used only when a treadmill is displayed in a store. When the console is in the demo mode, the power cord can be plugged in, the key can be removed from the console, and the displays and indicators on the console will automatically light in a preset sequence, although the buttons on the console will not operate. **If a “d” appears in the Calories display when the information mode is selected, press the Speed  $\nabla$  button so the Calories display is blank.**

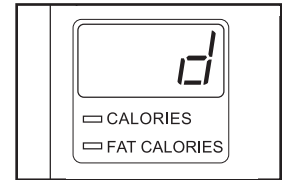

To exit the information mode, remove the key from the console.

# HOW TO FOLD AND MOVE THE TREADMILL

## HOW TO FOLD THE TREADMILL FOR STORAGE

Before folding the treadmill, adjust the incline to the lowest position. If this is not done, the treadmill may be permanently damaged. Next, unplug the power cord. **Caution: You must be able to safely lift 45 pounds (20 kg) in order to raise, lower, or move the treadmill.**

1. Hold the treadmill in the locations shown at the right. **To decrease the possibility of injury, bend your legs and keep your back straight. As you raise the treadmill, make sure to lift with your legs rather than your back.** Raise the treadmill about halfway to the vertical position.

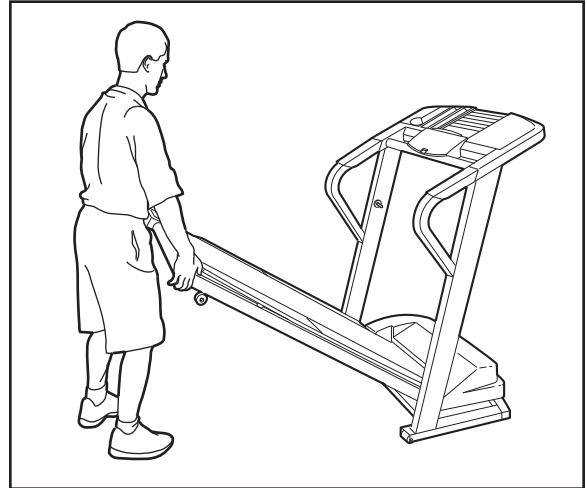

2. Move your right hand to the position shown and hold the treadmill firmly. Using your left hand, pull the lock knob to the left and hold it. Raise the treadmill until all parts of the treadmill are past the latch pin. Release the lock knob. **Make sure that the lock knob is fully released so the latch pin is securely holding the catch.**

**To protect the floor or carpet from damage, place a mat under the treadmill. Keep the treadmill out of direct sunlight. Do not leave the treadmill in the storage position in temperatures above 85° Fahrenheit.**

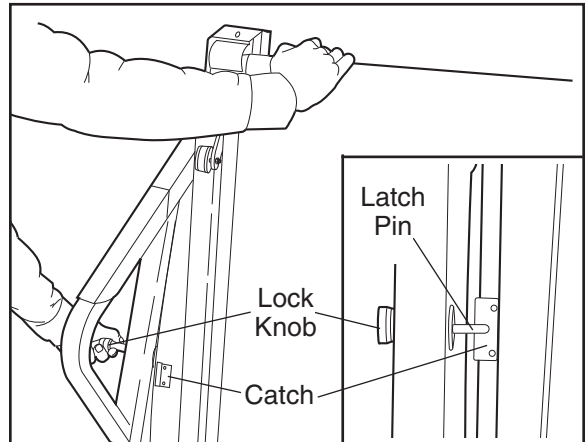

## HOW TO MOVE THE TREADMILL

Before moving the treadmill, convert the treadmill to the storage position as described above. **Make sure that the latch pin is securely holding the catch.**

1. Hold the handrails and place one foot on the base.
2. Tilt the treadmill back until it rolls freely on the wheels. Carefully move the treadmill to the desired location. **To reduce the risk of injury, use extreme caution while moving the treadmill. Do not attempt to move the treadmill over an uneven surface.**
3. Place one foot on the base, and carefully lower the treadmill until it is resting in the storage position.



## HOW TO LOWER THE TREADMILL FOR USE

1. Hold the treadmill with your right hand as shown. Using your left hand, pull the lock knob to the left and hold it. Pivot the treadmill down until the frame and foot rails are past the pin. Slowly release the lock knob.

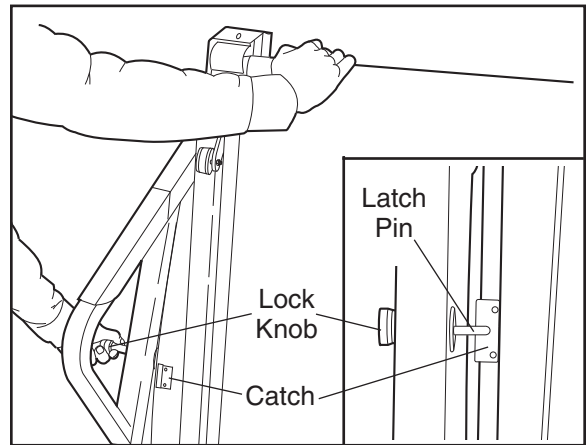

2. Hold the treadmill firmly with both hands and lower the treadmill to the floor. **To decrease the possibility of injury, bend your legs and keep your back straight.**

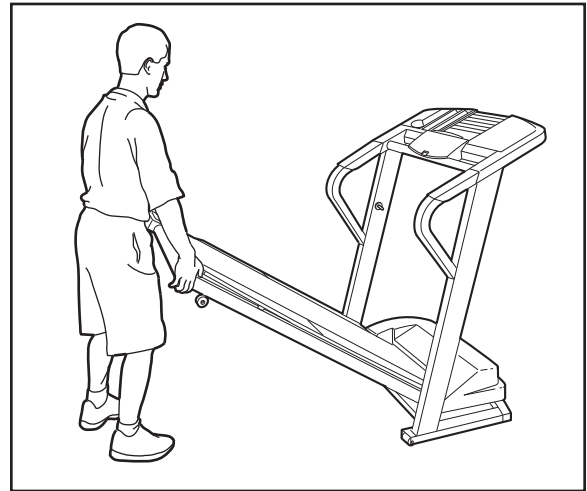

# TROUBLE-SHOOTING AND MAINTENANCE

Most treadmill problems can be solved by following the instructions below. If further assistance is needed, please call our Customer Service Department toll-free at 1-800-999-3756, Monday through Friday, 6 a.m. until 6 p.m. Mountain Time (excluding holidays).

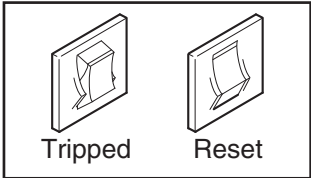
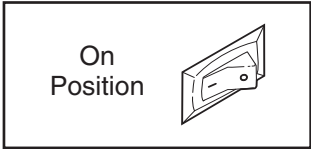
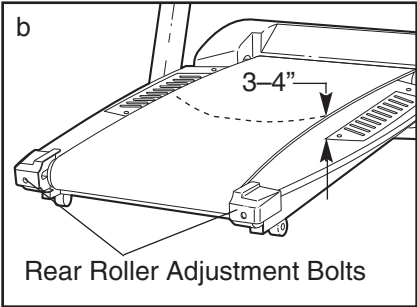
PROBLEM	SOLUTION	
<b>1. The power does not turn on</b>	a. Make sure that the power cord is plugged into a surge suppressor, and that the surge suppressor is plugged into a properly grounded outlet (see page 7). Use only a single-outlet surge suppressor that is UL 1449 listed as a transient voltage surge suppressor (TVSS). The surge suppressor must have a UL suppressed voltage rating of 400 volts or less and a minimum surge dissipation of 450 joules. The surge suppressor must be electrically rated for 120 volts AC and 15 amps. Important: The treadmill is not compatible with GFCI-equipped outlets.	
	b. Make sure that the key is fully inserted into the console.	
	c. Check the circuit breaker located on the frame near the power cord. If the switch protrudes as shown, the circuit breaker has tripped. To reset the circuit breaker, wait for five minutes and then press the switch back in.	
	d. Check the on/off switch located on the frame near the power cord. The switch must be in the on position.	
<b>2. The power turns off during use</b>	a. Check the circuit breaker located on the treadmill frame near the power cord (see 1. c. above). If the circuit breaker has tripped, wait for five minutes and then press the switch back in.	
	b. Make sure that the power cord is plugged in.	
	c. Remove the key from the console and then reinsert it.	
	d. Make sure that the on/off switch is in the on position (see 1. d. above).	
<b>3. The walking belt slows when walked on</b>	a. Make sure that only an appropriate surge protector is used (see 1. a. above).	
	b. If the walking belt is overtightened, treadmill performance may decrease and the walking belt may be permanently damaged. Remove the key and <b>UNPLUG THE POWER CORD</b> . Using the included allen wrench, turn both rear roller adjustment bolts counterclockwise 1/4 of a turn. When the walking belt is properly tightened, you should be able to lift <b>the edges</b> of the walking belt 3 to 4 inches off the walking platform. Be careful to keep the walking belt centered. Plug in the power cord, insert the key and run the treadmill for a few minutes. Repeat until the walking belt is properly tightened.	

**PROBLEM**

**SOLUTION**

**4. The walking belt is off-center or slips when walked on**

a. **If the walking belt has shifted to the left**, first remove the key and **UNPLUG THE POWER CORD**. Using the allen wrench, turn the left rear roller adjustment bolt clockwise, and the right bolt counterclockwise, 1/4 of a turn each. Be careful not to overtighten the walking belt. Plug in the power cord, insert the key and run the treadmill for a few minutes. Repeat until the walking belt is centered.

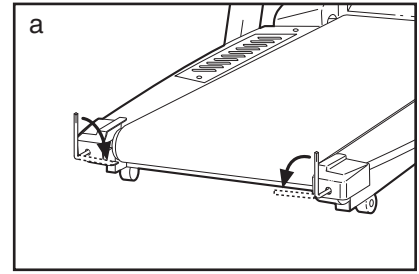

b. **If the walking belt has shifted to the right**, first remove the key and **UNPLUG THE POWER CORD**. Using the allen wrench, turn the left rear roller adjustment bolt counterclockwise, and the right bolt clockwise, 1/4 of a turn each. Be careful not to overtighten the walking belt. Plug in the power cord, insert the key and run the treadmill for a few minutes. Repeat until the walking belt is centered.

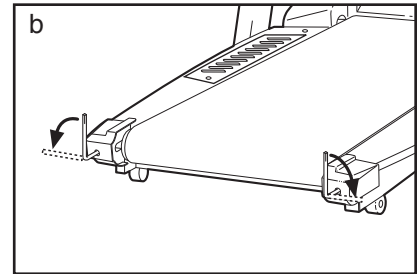

c. **If the walking belt slips when walked on**, first remove the key and **UNPLUG THE POWER CORD**. Using the allen wrench, turn both rear roller adjustment bolts clockwise, 1/4 of a turn. When the walking belt is correctly tightened, you should be able to lift the edges of the walking belt 3 to 4 inches off the walking platform. Be careful to keep the walking belt centered. Plug in the power cord, insert the key and run the treadmill for a few minutes. Repeat until the walking belt is properly tightened.

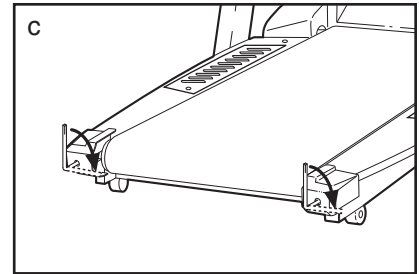

**5. The displays of the console do not function properly**

a. Remove the key from the console and **UNPLUG THE POWER CORD**. Next, remove the screws from the hood and carefully remove the hood. Locate the Reed Switch (26) and the Magnet (85) on the left side of the Pulley (28). Turn the Pulley until the Magnet is aligned with the Reed Switch. **Make sure that the gap between the Magnet and the Reed Switch is about 1/8"**. If necessary, loosen the Reed Switch Screw (2) and move the Reed Switch slightly. Retighten the Screw. Re-attach the hood and run the treadmill for a few minutes to check for a correct speed reading.

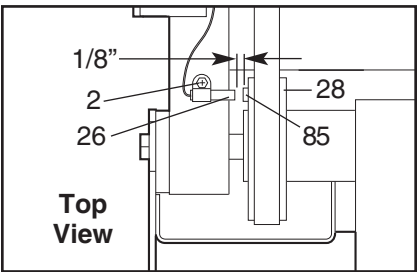

**6. Bubbles form in the walking belt**

a. Due to variations in humidity and temperature, there is a possibility that bubbles may form in the walking belt. Although the bubbles will disappear with time, you may unplug the power cord, carefully insert a needle into the bubbles, and push the air out of the bubbles.



**PROBLEM****SOLUTION****7. The handgrip pulse sensor does not function properly**

- a. **Make sure to stand on the foot rails and avoid moving your hands while measuring your heart rate.** Excessive movement may interfere with heart rate readings. If the handgrip pulse sensor is not used correctly, your heart rate will not be shown.
- b. Do not hold the metal contacts too tightly; doing so may interfere with heart rate readings.
- c. For the most accurate heart rate reading, hold the contacts for about 15 seconds.
- d. For optimal performance of the handgrip pulse sensor, keep the contacts clean. The contacts can be cleaned with a soft cloth—never use alcohol, abrasives, or chemicals.

**8. The chest pulse sensor does not function properly**

- a. If the chest pulse sensor does not function properly, see CHEST PULSE SENSOR TROUBLE-SHOOTING on page 6.

- b. If the chest pulse sensor still does not function properly, the battery should be changed. To replace the battery, locate the battery cover on the back of the sensor unit. Insert a coin into the slot in the cover and turn the cover counterclockwise to the “open” position. Remove the cover.

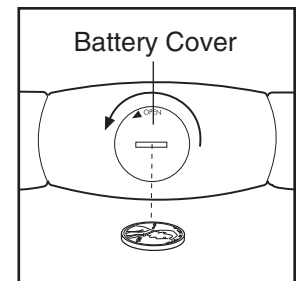

Remove the old battery from the sensor unit. Insert a new **CR 2032 battery**, making sure that the writing is on top. In addition, make sure that the rubber gasket is in place in the sensor unit. Replace the battery cover and turn it to the closed position.

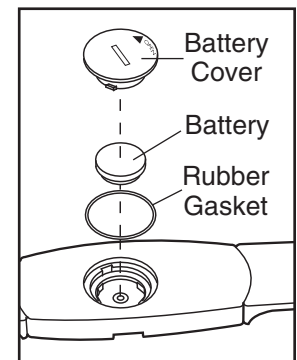

# CONDITIONING GUIDELINES

**⚠️ WARNING:** Before beginning this or any exercise program, consult your physician. This is especially important for individuals over the age of 35 or individuals with pre-existing health problems.

The pulse sensor is not a medical device. Various factors, including your movement, may affect the accuracy of heart rate readings. The sensor is intended only as an exercise aid in determining heart rate trends in general.

The following guidelines will help you to plan your exercise program. Remember—these are general guidelines only. For more detailed exercise information, obtain a reputable book or consult your physician.

## EXERCISE INTENSITY

Whether your goal is to burn fat or to strengthen your cardiovascular system, the key to achieving the desired results is to exercise with the proper intensity. The proper intensity level can be found by using your heart rate as a guide. The chart below shows recommended heart rates for fat burning and aerobic exercise.

AEROBIC	165	155	145	140	130	125	115
MAX FAT BURN	145	138	130	125	118	110	103
FAT BURN	125	120	115	110	105	95	90
Age	20	30	40	50	60	70	80

To find the proper heart rate for you, first find your age near the bottom of the chart (ages are rounded off to the nearest ten years). Next, find the three numbers above your age. The three numbers define your “training zone.” The lower two numbers are recommended heart rates for fat burning; the higher number is the recommended heart rate for aerobic exercise.

To measure your heart rate during exercise, use the chest pulse sensor. If your heart rate is too high or too low, adjust the speed and incline of the treadmill.

## Fat Burning

To burn fat effectively, you must exercise at a relatively low intensity level for a sustained period of time. During the first few minutes of exercise, your body uses easily accessible *carbohydrate calories* for en-

ergy. Only after the first few minutes does your body begin to use stored *fat calories* for energy. If your goal is to burn fat, adjust the speed and incline of the treadmill until your heart rate is near the lowest number in your training zone.

For maximum fat burning, adjust the speed and incline of the treadmill until your heart rate is near the middle number in your training zone.

## Aerobic Exercise

If your goal is to strengthen your cardiovascular system, your exercise must be “aerobic.” Aerobic exercise is activity that requires large amounts of oxygen for prolonged periods of time. This increases the demand on the heart to pump blood to the muscles, and on the lungs to oxygenate the blood. For aerobic exercise, adjust the speed and incline of the treadmill until your heart rate is near the highest number in your training zone.

## WORKOUT GUIDELINES

Each workout should include the following three parts:

**A Warm-up**—Start each workout with 5 to 10 minutes of stretching and light exercise. A proper warm-up increases your body temperature, heart rate and circulation in preparation for exercise.

**Training Zone Exercise**—After warming up, increase the intensity of your exercise until your pulse is in your training zone for 20 to 60 minutes. (During the first few weeks of your exercise program, do not keep your pulse in your training zone for longer than 20 minutes.) Breathe regularly and deeply as you exercise—never hold your breath.

**A Cool-down**—Finish each workout with 5 to 10 minutes of stretching to cool down. This will increase the flexibility of your muscles and will help prevent post-exercise problems.

## Exercise Frequency

To maintain or improve your condition, complete three workouts each week, with at least one day of rest between workouts. After a few months, you may complete up to five workouts each week if desired.

The key to success is to make exercise a regular and enjoyable part of your everyday life.

## SUGGESTED STRETCHES

The correct form for several basic stretches is shown at the right. Move slowly as you stretch—never bounce.

### 1. Toe Touch Stretch

Stand with your knees bent slightly and slowly bend forward from your hips. Allow your back and shoulders to relax as you reach down toward your toes as far as possible. Hold for 15 counts, then relax. Repeat 3 times. Stretches: Hamstrings, back of knees and back.

### 2. Hamstring Stretch

Sit with one leg extended. Bring the sole of the opposite foot toward you and rest it against the inner thigh of your extended leg. Reach toward your toes as far as possible. Hold for 15 counts, then relax. Repeat 3 times for each leg. Stretches: Hamstrings, lower back and groin.

### 3. Calf/Achilles Stretch

With one leg in front of the other, reach forward and place your hands against a wall. Keep your back leg straight and your back foot flat on the floor. Bend your front leg, lean forward and move your hips toward the wall. Hold for 15 counts, then relax. Repeat 3 times for each leg. To cause further stretching of the achilles tendons, bend your back leg as well. Stretches: Calves, achilles tendons and ankles.

### 4. Quadriceps Stretch

With one hand against a wall for balance, reach back and grasp one foot with your other hand. Bring your heel as close to your buttocks as possible. Hold for 15 counts, then relax. Repeat 3 times for each leg. Stretches: Quadriceps and hip muscles.

### 5. Inner Thigh Stretch

Sit with the soles of your feet together and your knees outward. Pull your feet toward your groin area as far as possible. Hold for 15 counts, then relax. Repeat 3 times. Stretches: Quadriceps and hip muscles.

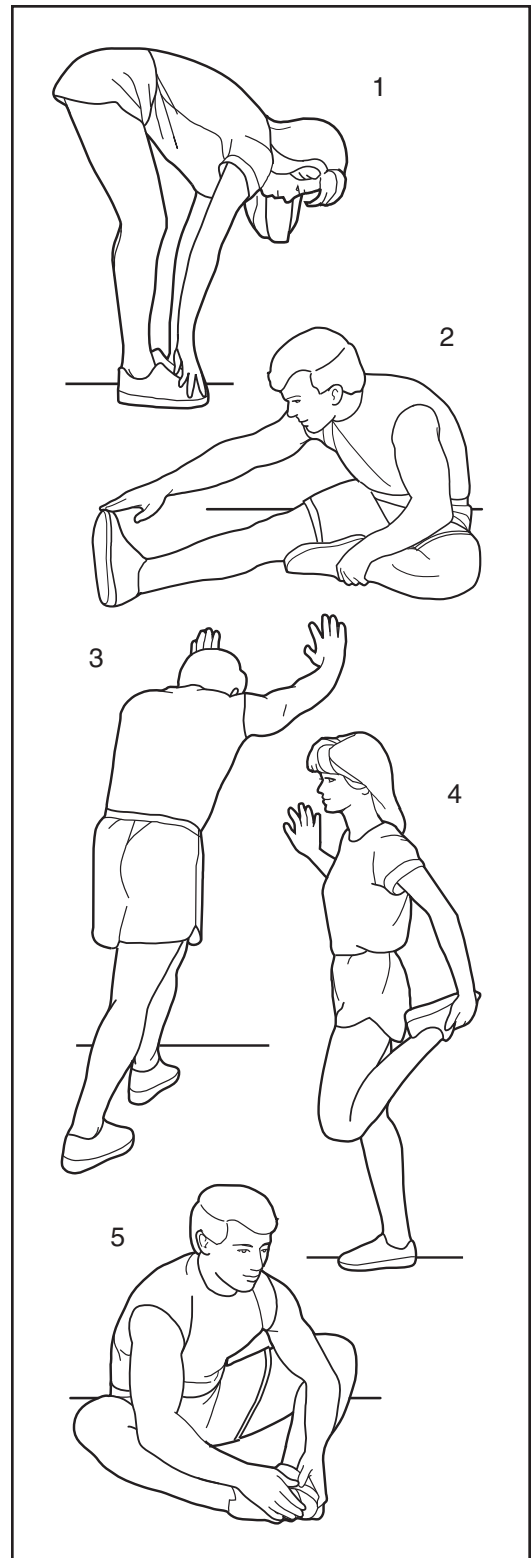

# PART LIST—Model No. HRTL16900

R1200A

To locate the parts listed below, refer to the EXPLODED DRAWING attached in the center of this manual.

Key No.	Qty.	Description	Key No.	Qty.	Description	Key No.	Qty.	Description
1	1	Motor Hood	49	1	Right Foot Grip	96	2	Upright Base Cap
2	11	Hood Screw	50	1	Walking Belt	97	3	Warning Decal
3	6	Platform Screw	51	1	Frame	98	2	Wheel Bolt
4	9	Platform Washer	52	2	Rear Wheel	99	2	Front Wheel
5	1	Latch Catch	53	2	Rear Wheel Bolt	100	2	Wheel Insert
6	2	Latch Catch Screw	54	2	Rear Roller Guard	101	1	12" Audio Wire
7	4	Isolator	55	2	Rear Wheel Nut	102	1	Large Warning Decal
8	4	Belt Guide Screw	56	1	Rear Roller	103	1	Upright
9	2	Belt Guide	57	1	Right Endcap	104	1	Shock
10	2	Frame Pivot Bolt	58	2	Rear Roller Adj. Washer	105	2	Lift Frame Spacer
11	1	Front Roller/Pulley				106	4	Roller Guard Screws
12	2	Incline Motor Spacer	59	2	Rear Roller Adj. Bolt	107	4	Motor Nut
13	2	Incline Motor Bolt	60	1	Left Endcap	108	12	Nylon Washer
14	2	Incline Motor Nut	61	1	Allen Wrench	109	1	Motor Bracket
15	1	Incline Motor	62	1	Walking Platform	110	1	Chest Pulse Sensor
16	1	Front Roller Adj. Nut	63	2	Handrail Grip	111	1	Chest Pulse Strap
17	1	Pulse Mounting Plate	64	4	Handrail Grip Screw	112	1	Stop Bracket
18	1	Front Roller Adj. Bolt	65	2	Crossbar Bolt	113*	1	Latch Assembly
19	2	Side Hood Tab	66	2	Crossbar Washer	114	2	Static Decal
20	11	Hood Tab Screw	67	1	Lock Knob	#	1	8" Green Wire, 2 Ring
21	1	Ground Screw	68	1	Lock Knob Sleeve	#	1	7" Green Wire, M/Ring
22	2	Front Hood Tab	69	1	Lock Spring	#	2	4" Green Wire, F/Ring
23	1	Reed Switch Clip	70	2	Lock Knob Collar	#	1	8" Black Wire, 2 Ring
24	1	Ground Wire	71	1	Pin Clip	#	1	4" Black Wire, M/F
25	1	2-lb. Hand Weight	72	1	Lock Pin	#	1	4" Black Wire, 2 Female
26	1	Reed Switch	73	1	Hand Grip Pulse Bar			
27	1	Motor Belt	74	3	Console Base Screw	#	1	20" Blue Wire, 2 F
28	4	Motor Washer	75	1	Console Base Cover	#	1	8" Blue Wire, M/F
29	2	Motor Tension Bolt	76	8	Cover Screw	#	1	4" Blue Wire, 2 F
30	2	Motor Tension Washer	77	1	Pulse Sensor Cover	#	1	20" White Wire, M/F
			78	2	Sensor Cover Screw	#	1	8" White Wire, 2 Female
31	2	Motor Star Washer	79	1	Key/Clip			
32	1	Motor Tension Nut	80	1	Console Base	#	1	4" Red Wire, M/F
33	1	Motor Pivot Bolt	81	1	Book Holder Lens	#	1	User's Manual
34	1	Motor	82	1	Console			
35	16	Screw	83	1	Lift Frame			* Includes all parts shown in the box.
36	4	Motor Bushing	84	1	Releasable Tie			
37	1	Motor Bolt	85	1	Magnet			#These parts are not illustrated
38	1	Circuit Breaker	86	1	Cable Tie			
39	1	On/Off Switch	87	1	12" Power Wire			Specifications are subject to change without notice.
40	1	Power Cord	88	1	8" Cable Tie			
41	1	Power Cord Grommet	89	1	Jack			
42	1	Outlet Bracket	90	1	iFIT.com Wire			
43	1	Controller	91	2	Lift Frame Bolt			
44	1	Power Supply	92	8	Plastic Washer			
45	4	Plastic Stand-Off	93	7	Lift Frame Nut/Wheel Nut			
46	1	Electronics Bracket						
47	1	Belly Pan	94	5	Base Pad			
48	1	Upright Wire Harness	95	1	Left Foot Grip			

---

# HOW TO ORDER REPLACEMENT PARTS

To order replacement parts, call our Customer Service Department toll-free at 1-800-999-3756, Monday through Friday, 6 a.m. until 6 p.m. Mountain Time (excluding holidays). Before calling, please note the following information:

- The MODEL NUMBER of the product (HRTL16900)
- The NAME of the product (HealthRider® SOFTSTRIDER S700xi™ treadmill)
- The SERIAL NUMBER of the product (see the front cover of this manual)
- The KEY NUMBER and DESCRIPTION of the replacement part(s) (see the PART LIST on page 30 and the EXPLODED DRAWING attached in the center of this manual).

# EXPLODED DRAWING—Model No. HRTL16900

R1200A

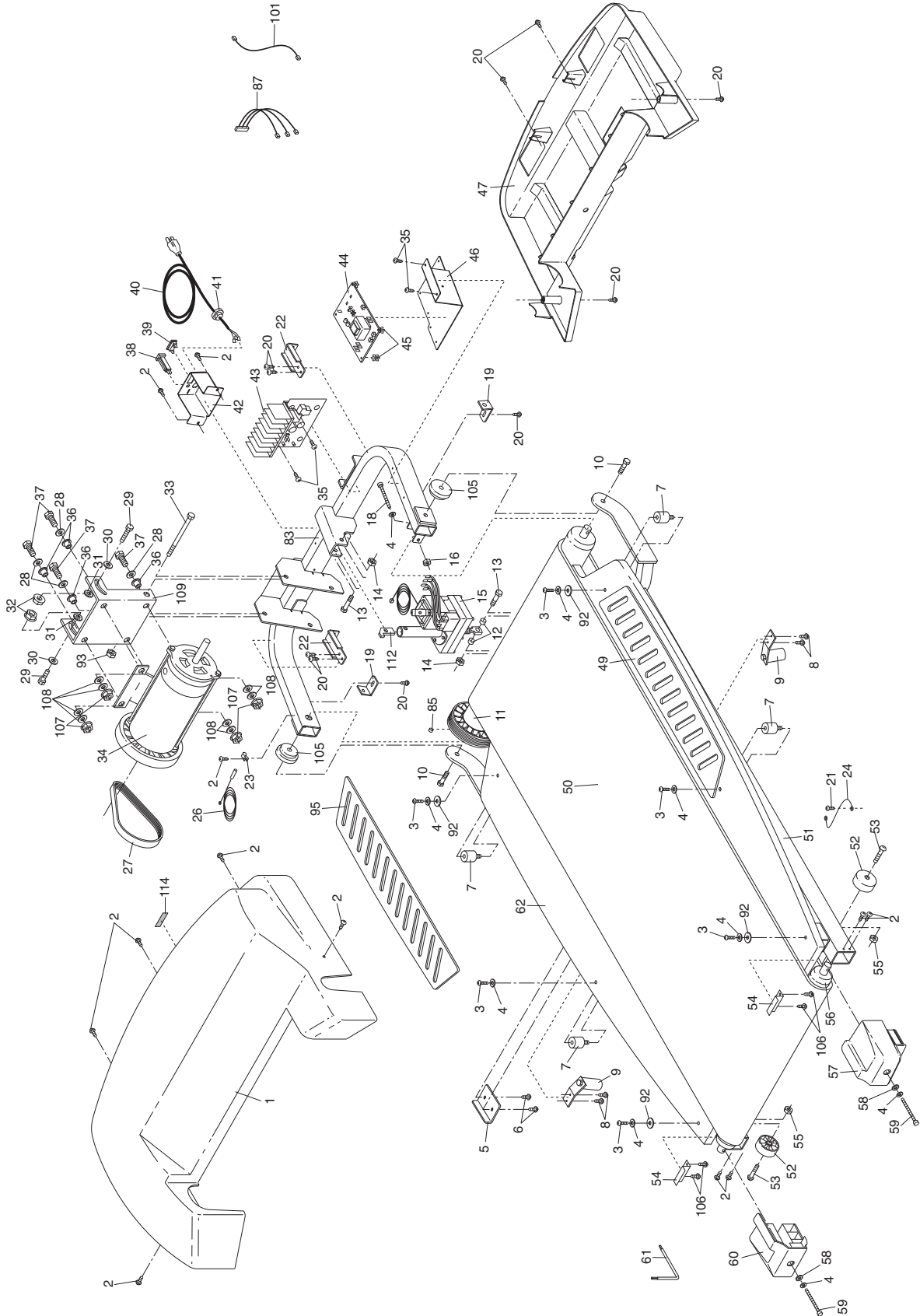



# EXPLODED DRAWING—Model No. HRTL16900

R1200A

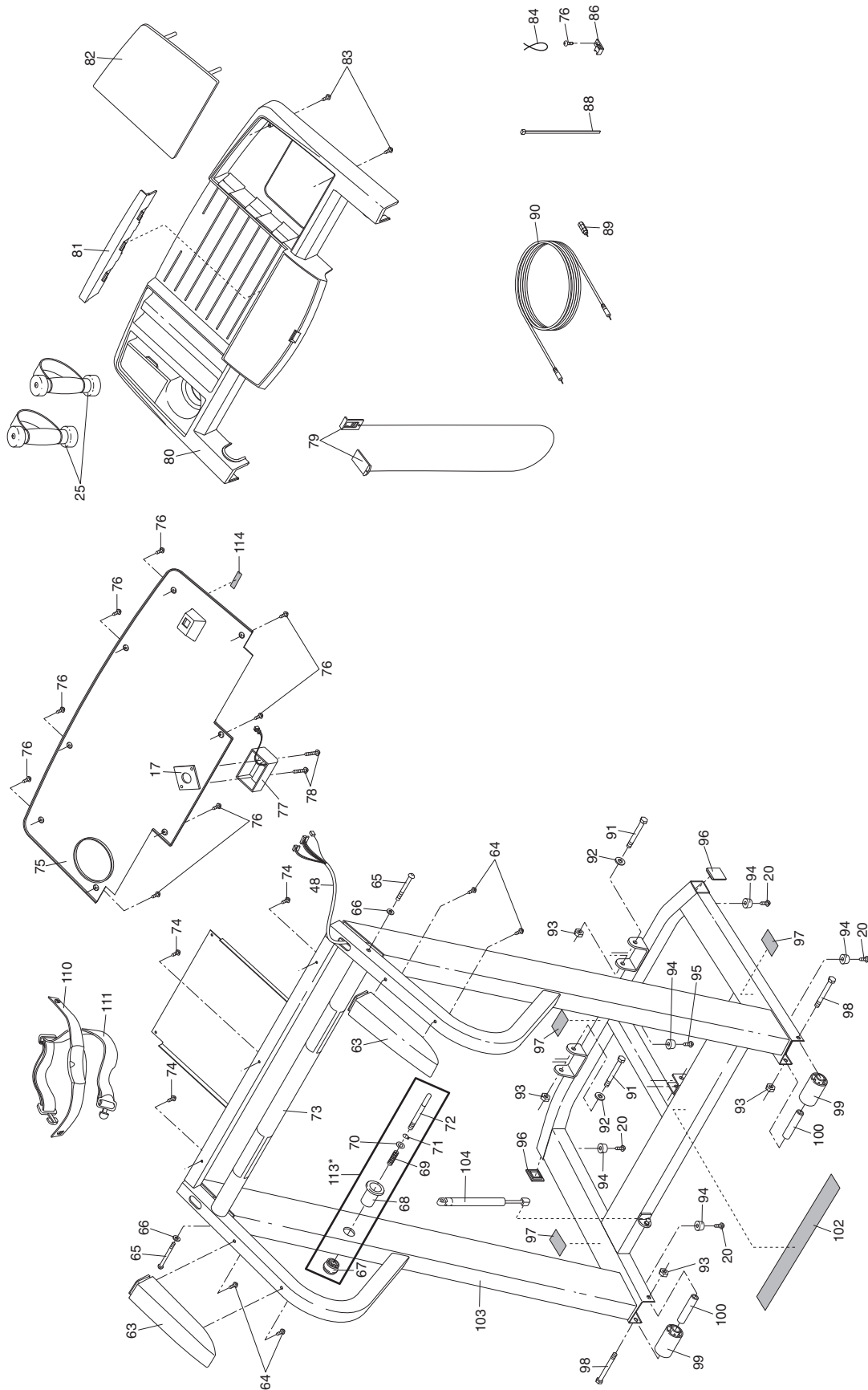

## LIMITED WARRANTY

**WHAT IS COVERED**—The entire HealthRider® SOFTSTRIDER S700xi™ treadmill (“Product”) is warranted to be free of all defects in material and workmanship.

**WHO IS COVERED**—The original purchaser or any person receiving the Product as a gift from the original purchaser.

**HOW LONG IS IT COVERED**—ICON Health & Fitness, Inc. (“ICON”), extends a lifetime warranty on the frame. The motor is covered for three years after the date of purchase. The belt and deck are covered for two years after the date of purchase. All mechanical components are covered for two years after the date of purchase. All electrical components are covered for two years after the date of purchase. Labor is covered for one year.

**WHAT WE DO TO CORRECT COVERED DEFECTS**—We will ship to you, without charge, any replacement part or component, providing the repairs are authorized by ICON first and are performed by an ICON trained and authorized service provider, or, at our option, we will replace the Product.

**WHAT IS NOT COVERED**—Any failures or damage caused by unauthorized service, misuse, accident, negligence, improper assembly or installation, alterations, modifications without our written authorization or by failure on your part to use, operate, and maintain as set out in your User’s Manual (“Manual”). This warranty does not extend to products used for commercial or rental purposes or to products used as store display modules.

**WHAT YOU MUST DO**—Always retain proof of purchase, such as your bill of sale; store, operate, and maintain the Product as specified in the Manual; notify our Customer Service Department of any defect within 10 days after discovery of the defect; as instructed, return any defected part for replacement or, if necessary, the entire product, for repair.

**USER’S MANUAL**—It is VERY IMPORTANT THAT YOU READ THE MANUAL before operating the Product. Remember to do the periodic maintenance requirements specified in the Manual to assure proper operation and your continued satisfaction.

**HOW TO GET PARTS AND SERVICE**—Simply call our Customer Service Department at 1-800-999-3756 and tell them your name and address and the serial number of your Product. They will tell you how to get a part replaced, or if necessary, arrange for service where your Product is located or advise you how to ship the Product for service. Before shipping, always obtain a Return Authorization Number (RA No.) from our Customer Service Department; securely pack your Product (save the original shipping carton if possible); put the RA No. on the outside of the carton and insure the product. Include a letter explaining the product or problem and a copy of your proof of purchase if you believe the service is covered by warranty.

ICON is not responsible or liable for indirect, special or consequential damages arising out of or in connection with the use or performance of the product or damages with respect to any economic loss, loss of property, loss of revenues or profits, loss of enjoyment or use, costs of removal, installation or other consequential damages of whatsoever nature. Some states do not allow the exclusion or limitation of incidental or consequential damages. Accordingly, the above limitation may not apply to you.

The warranty extended hereunder is in lieu of any and all other warranties and any implied warranties of merchantability or fitness for a particular purpose is limited in its scope and duration to the terms set forth herein. Some states do not allow limitations on how long an implied warranty lasts. Accordingly, the above limitation may not apply to you.

No one is authorized to change, modify or extend the terms of this limited warranty.

This warranty gives you specific legal rights and you may have other rights which vary from state to state.

**ICON HEALTH & FITNESS, INC., 1500 S. 1000 W., LOGAN, UT 84321-9813**

HealthRider® is a registered trademark of ICON Health & Fitness, Inc.

## Free Manuals Download Website

<http://myh66.com>

<http://usermanuals.us>

<http://www.somanuals.com>

<http://www.4manuals.cc>

<http://www.manual-lib.com>

<http://www.404manual.com>

<http://www.luxmanual.com>

<http://aubethermostatmanual.com>

Golf course search by state

<http://golfingnear.com>

Email search by domain

<http://emailbydomain.com>

Auto manuals search

<http://auto.somanuals.com>

TV manuals search

<http://tv.somanuals.com>