

HEAT CONTROLLER, INC.

OWNER'S MANUAL

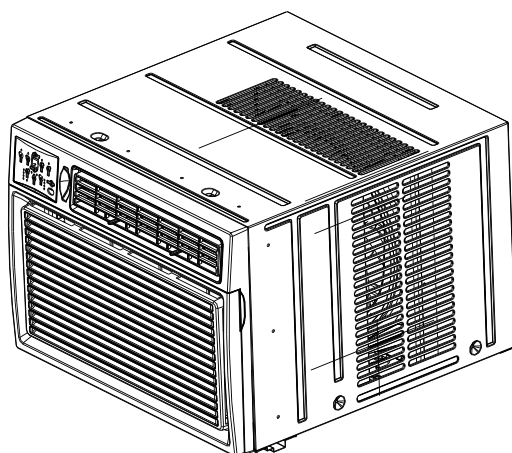

Room Air Conditioner with R-410A:

REG-183H

REG-253H

RADS-151H

RADS-183H

RADS-253H

CONTENTS

- 1. SAFETY PRECAUTIONS.....2
- 2. IMPORTANT SAFETY INSTRUCTIONS4
- 3. NORMAL SOUNDS5
- 4. AIR CONDITIONER FEATURES5
- 5. INSTALLATION INSTRUCTIONS.....10
- 6. CARE AND CLEANING18
- 7. TROUBLESHOOTING TIPS.....19

Read This Manual

Inside you will find many helpful hints on how to use and maintain your air conditioner properly. Just a little preventive care on your part can save you a great deal of time and money over the life of your air conditioner. You'll find many answers to common problems in the chart of troubleshooting tips. If you review our chart of Troubleshooting Tips first, you may not need to call for service at all.



CAUTION

- Contact an authorized service technician for repair or maintenance of this unit.
- Contact an authorized installer for installation of this unit.
- If the power cord needs to be replaced, replacement work shall be performed by authorized service personnel only.
- Installation work must be performed in accordance with the national and local electric codes and must be performed by authorized personnel only.



NOTE: All the illustrations in this manual are for explanation purposes only. Your air conditioner may be slightly different.

Safety Precautions

To prevent injury to the user and proper damage, the following instructions must be followed. Incorrect operation due to ignoring instructions may cause harm or damage. The seriousness is classified by the following indications.

 WARNING	This symbol indicates the possibility of death or serious injury.
 CAUTION	This symbol indicates the possibility of injury or damage to property.

■ Meanings of symbols used in this manual are as shown below.

	Never do this.
	Always do this.

WARNING

 **Plug in power cord plug properly**

- Otherwise, it may cause electric shock or fire due to excess heat generation

 **Do not open the unit during operation**

- It may cause electric shock

 **Always ensure effective grounding**

- Incorrect grounding may cause electric shock

 **Do not modify power cord length or share the outlet with other appliances.**

- It may cause electric shock or fire due to heat generation

 **Do not operate or stop the unit by inserting or pulling out the power plug**

- It may cause electric shock or fire due to heat generation

 **Unplug the unit if strange sounds, odors or smoke comes from it.**

- It may cause fire and electric shock

 **Do not operate with wet hands or in a damp environment**

- It may cause electric shock

 **Do not use the power cord close to heating appliances**

- It may cause fire and electric shock

 **Do not allow water to run in to electric parts**

- It may cause failure of machine or electric shock

 **Unplug the unit if strange sounds, odors or smoke comes from it.**

- It may cause fire and electric shock

 **Always install circuit breaker and a dedicated power circuit**

- Incorrect installation may cause fire and electric shock

 **Do not use the socket if it is loose or damaged**

- It may cause fire and electric shock

 **Do not use a damaged or unspecified power cord**

- It may cause electric shock or fire
- If the power cord is damaged, it must be replaced by the manufacturer or an authorized service center or a qualified person in order to avoid a hazard

 **Do not use the power cord near flammable gas or combustibles, such as gasoline, benzene, thinner, etc.**

- It may cause an explosion or fire

 **Do not disassemble or modify unit.**

- It may cause failure and electric shock

 **CAUTION**

 When the air filter is to be removed, do not touch the metal parts of the unit

- It may cause an injury due to sharp edges of components.

 Do not allow water to enter inside the unit during cleaning

- Water may enter the unit and degrade the insulation. It may cause an electric shock

 Ventilate the room well when used together with a gas stove or if there is a gas leak

- An oxygen shortage may occur
- May cause explosion, fire and/or burns

 When the unit is to be cleaned, switch off, and turn off the circuit breaker

- Do not clean unit when power is on as it may cause fire and electric shock

 Hold the plug by the head of the power plug when taking it out

- It may cause electric shock and damage

 Turn off the main power switch when not using the unit for a long time

- It may cause failure of product or fire

 Stop operation and close the window in storm or hurricane

- Operation with windows opened may allow rain to enter inside and damage property

 Ensure that the installation bracket of the outdoor appliance is not damaged

- If bracket is damaged, there is concern of damage due to falling of unit.

 Always insert the filters securely. Clean filter once every two weeks

- Operation without filters may cause failure
- Operation with dirty/clogged filters may cause failure

 Do not place obstacles around air-inlets or inside of air-outlet

- It may cause failure of appliance or accident

 Do not place heavy object on the power cord and ensure that the cord is not compressed

- There is danger of fire or electric shock

 Do not drink water drained from air conditioner

- It contains contaminants and could make you sick

 Do not use strong detergents such as wax or thinner; use a damp, soft cloth

- Appearance may be deteriorated due to change of product color or scratching of its surface

 Use caution when unpacking and installing

- Sharp edges could cause injury

 If water enters the unit, turn the unit off at the power outlet and switch off the circuit breaker. Isolate supply by taking power-plug out and contact a qualified service technician

- Water may enter the unit and degrade the insulation. It may cause an electric shock

IMPORTANT SAFETY INSTRUCTIONS

NOTE For some models, the power supply cord with this air conditioner contains a current detection device designed to reduce the risk of fire. Please refer to the section "Operation of Current Device" for details. In the event that the power supply cord is damaged, it cannot be repaired—it must be replaced with a cord from the Product Manufacturer.

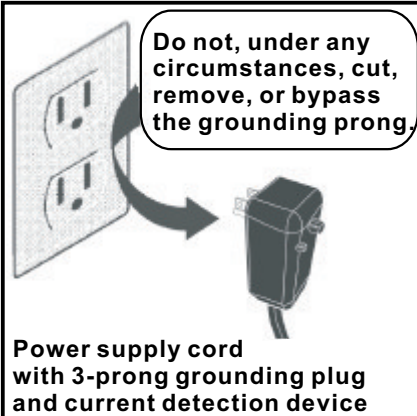

⚠ WARNING For your safety

- Do not store or use gasoline or other flammable vapors and liquids in the vicinity of this or any other appliance.
- Avoid fire hazard or electric shock. Do not use an extension cord or an adaptor plug. Do not remove any prong from the power cord.

⚠ WARNING Electrical Information

- Be sure the electrical service is adequate for the model you have chosen. This information can be found on the serial plate, which is located on the side of the cabinet and behind the grille.
- Be sure the air conditioner is properly grounded. To minimize shock and fire hazards, proper grounding is important. The power cord is equipped with a three-prong grounding plug for protection against shock hazards.
- Your air conditioner must be used in a properly grounded wall receptacle. If the wall receptacle you intend to use is not adequately grounded or protected by a time delay fuse or circuit breaker, have a qualified electrician install the proper receptacle.
- Ensure the receptacle is accessible after the unit installation.
- Do not run air conditioner without side protective cover in place. This could result in mechanical damage within the air conditioner.
- **Do not use an extension cord or an adapter plug.**

Operation of Current Device

The power supply cord contains a current device that senses damage to the power cord. To test your power supply cord do the following:

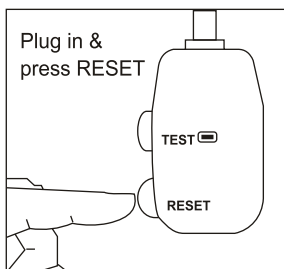

NOTE: Some plugs have buttons on the top.

1. Plug in the Air Conditioner.
2. The power supply cord will have TWO buttons on the plug head. Press the TEST button, you will notice a click as the RESET button pops out.
3. Press the RESET button, again you will notice a click as the button engages.
4. The power supply cord is now supplying electricity to the unit. (On some products this it also indicated by a light on the plug head.)

NOTES:

- Do not use this device to turn the unit on or off.
- Always make sure the RESET button is pushed in for correct operation.
- The power supply must be replaced if it fails reset when either the TEST button is pushed, or it cannot be reset. A new one can be obtained from the product manufacturer.
- If power supply cord is damaged, it cannot be repaired. It **MUST** be replaced by one obtained from the product manufacturer.

NORMAL SOUNDS

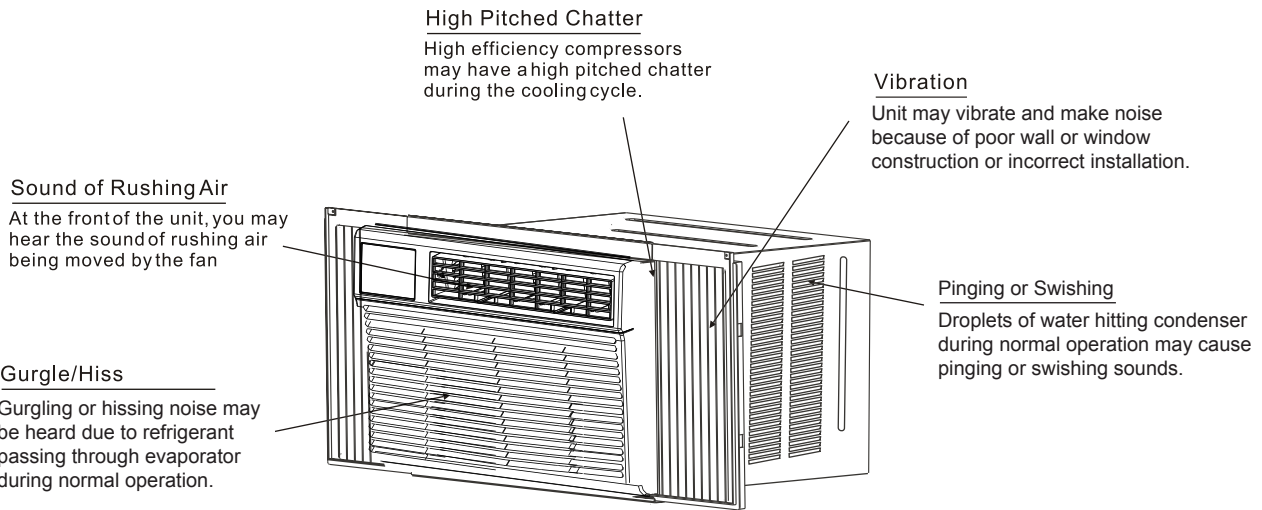

NOTE: This air conditioner is designed to be operated under condition as follows:

Cooling operation	Outdoor Temp:	64.4-109.4°F (18-43°C) (T ₁ Environment)	69.8-125.6°F (21-52°C) (T ₃ Environment)
	Indoor Temp:	62.6-89.6°F (17-32°C) (T ₁ Environment)	62.6-89.6°F (17-32°C) (T ₃ Environment)
Heat operation	Outdoor Temp:	23.0-75.2°F (-5-24°C) (T ₁ Environment)	19.4-75.2°F (-7-24°C) (T ₃ Environment)
	Indoor Temp:	32.0-80.6°F (0-27°C) (T ₁ Environment)	32.0-86.0°F (0-30°C) (T ₃ Environment)

Note: Performance may be reduced outside of these operating temperatures.

AIR CONDITIONER FEATURES

ELECTRONIC CONTROL OPERATING INSTRUCTIONS

Before you begin, thoroughly familiarize yourself with the control panel and remote as shown below and all its functions, then follow the symbol for the functions you desire. **The unit can be controlled by the unit control alone or with the remote.**

UNIT CONTROL

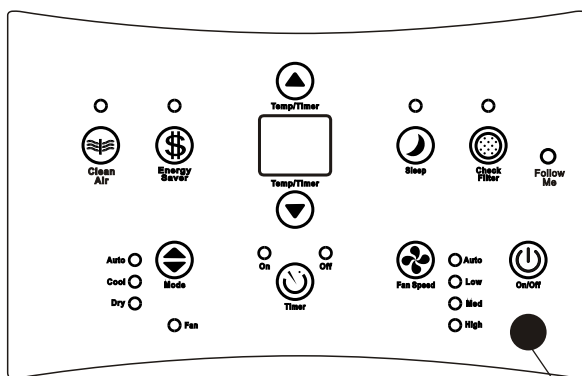

(Cooling Only Models)

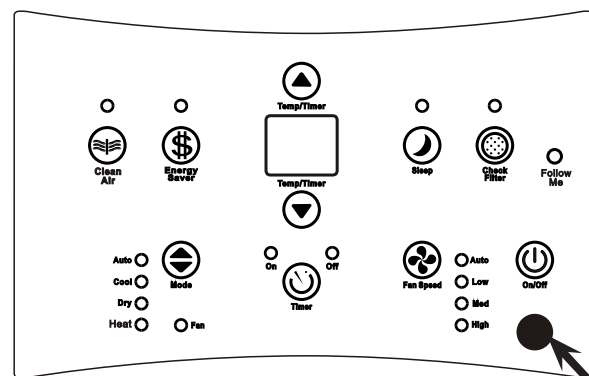

(Electric Heating models)

Remote signal receptor

Remote signal receptor

NOTE: Clear Air and/or Follow Me features only apply to certain models. Your control panel may or may not have these features and display lights. Check the actual unit you purchased to determine if these options apply.

AIR CONDITIONER FEATURES(CONTINUED)

NOTE: The following instructions represent the Unit Controls, the same instructions can be used for the Remote Control.

TO TURN UNIT ON:

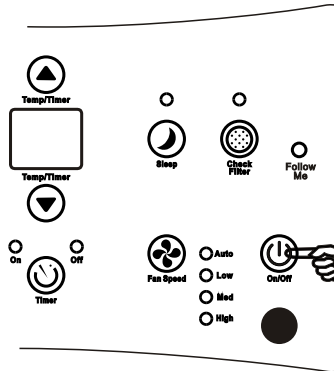

DO THIS:

Press the On/Off button.

TO CHANGE TEMPERATURE SETTING:

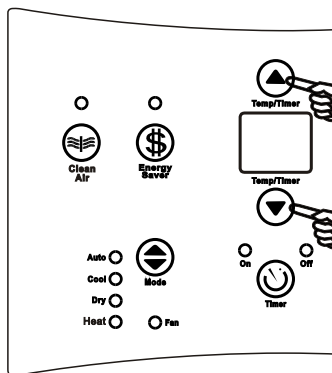

DO THIS:

Press to raise
Press to lower

Press or hold either Temp/Timer Up (▲) or Down (▼) button until the desired temperature is seen on the display. This temperature will be automatically maintained anywhere between 62°F (17°C) and 86°F (30°C). If you want the display to read the actual room temperature, see to "Operate on Fan Only" section.

TO ADJUST FAN SPEEDS:

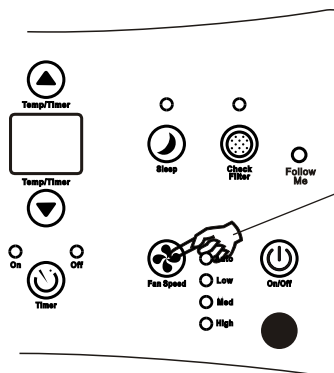

DO THIS:

Press to select
appropriate fan
speed

The fan speed button is used to select the Fan Speed in four steps: Auto, Low, Med or High. Each time the button is pressed, the fan speed mode is shifted. When the unit is operating in Dry mode, the fan speed is automatically controlled at Low fan speed.

AIR CONDITIONER FEATURES(CONTINUED)

TO SELECT THE OPERATING MODE:

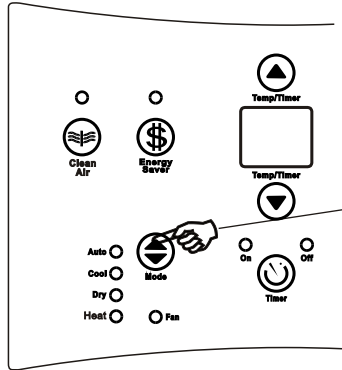

DO THIS:
Press the Mode button.

NOTE:

- To choose operating mode, press the Mode button. Each time you press the button, a mode is selected in a sequence that goes from Auto, Cool, Dry, Heat and Fan. The indicator light beside the selected mode will illuminate and remain on once the mode is selected.

To operate in Auto feature:

- When you set the air conditioner to AUTO mode, it will automatically select cooling, heating or fan only depending on what temperature you have selected and the room temperature.
- The air conditioner will control room temperature automatically around the temperature set point selected.
- In this mode, the fan speed cannot be adjusted, it starts automatically at a speed according to the room temperature.

To operate in Fan only:

- Use this function when cooling is not desired, such as for room air circulation or to exhaust stale air (on some models). Remember to open the vent during this function, but keep it closed during cooling for maximum cooling efficiency. You can choose any fan speed you prefer.
- During this function, the display will show the actual room temperature, not the set temperature as in the cooling mode.
- In Fan only mode, the temperature is not adjusted.

To operate in Dry mode:

- In this mode, the air conditioner will generally operate in the form of a dehumidifier to remove humidity from the air. However, some degree of cooling will continue.

TO USE THE ENERGY SAVER FEATURE:

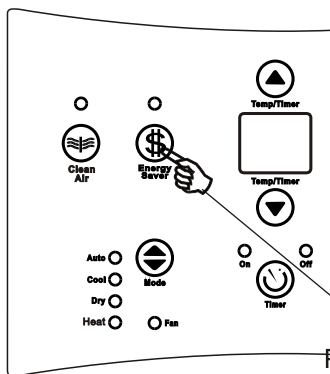

DO THIS:
Press the button

This function is available on COOL mode. The fan will continue to run for 3 minutes after the compressor shuts off. The fan then cycles on for 2 minutes at 10 minute intervals until the room temperature is above the set temperature, at which time the compressor turns back on and Cooling Starts.

AIR CONDITIONER FEATURES (CONTINUED)

SLEEP FEATURE:

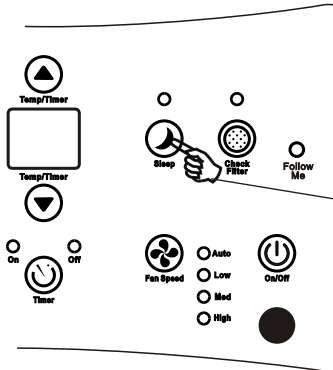

DO THIS:
Press Sleep button

In this mode the selected temperature will increase (cooling) or decrease (heating) by 2°F/1 (or 2)°C 30 minutes after the mode is selected. The temperature will then increase (cooling) or decrease (heating) by another 2°F/1 (or 2)°C after an additional 30 minutes. This new temperature will be maintained for 6 hours before it returns to the originally selected temperature. This ends the Sleep mode and the unit will continue to operate as originally programmed. The Sleep mode program can be cancelled at any time during operation by again pressing the Sleep button.

TIMER: AUTO START/STOP FEATURE

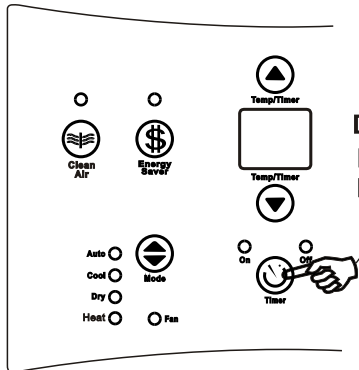

DO THIS:
Press Timer button

- When the unit is on or off, first press the Timer button, the TIMER ON indicator light illuminates. It indicates the Auto Start program is initiated.
- When the time of TIMER ON is displayed, press the Timer button again, the TIMER OFF indicator light illuminates. It indicates the Auto Stop program is initiated.
- Press or hold the Temp/Timer UP or DOWN button to change the Auto time by 0.5 hour increments, up to 10 hours, then count down the time remaining until start.
- The selected time will register in 5 seconds, and the system will automatically revert back to display the previous temperature setting or room temperature when the unit is on. (when the unit is off, there is no display.)
- Turning the unit ON or OFF at any time or adjusting the timer setting to 0.0 will cancel the Auto Start/Stop timed program.

CHECK FILTER FEATURE:

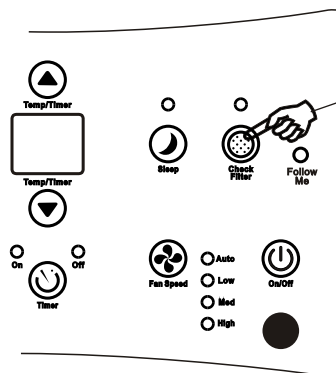

DO THIS:
Press Check Filter button

This feature is a reminder to clean the Air Filter for more efficient operation. The LED (light) will illuminate after 250 hours of operation. To reset after cleaning the filter, press the Check Filter button and the light will go off.

AIR CONDITIONER FEATURES (CONTINUED)

DISPLAYS:

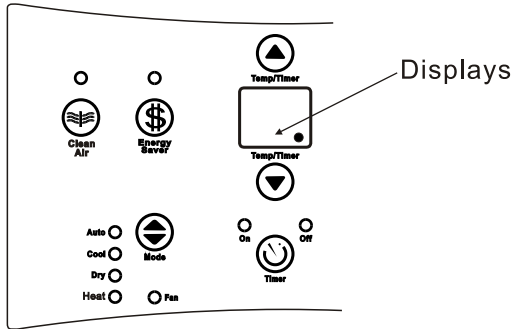

THE DISPLAYS

* The control is capable of displaying temperature in degree Fahrenheit or degrees Celsius. To convert from one to the other, press and hold the Left and Right Temp/Timer buttons at the same time, for 3 seconds.

Shows the set temperature in " °C" or " °F" and the Auto-timer settings. While on Fan only mode, it shows the room temperature.

Error codes:

AS-Room temperature sensor error-Unplug the unit and plug it back in. If error repeats, call for service.
NOTE: In Fan only mode, it will display "LO" or "HI".

- -Evaporator temperature sensor error-Unplug the unit and plug it back in. If error repeats, call for service.
NOTE: "•" is displayed as shown in the left picture.

ADDITIONAL THINGS YOU SHOULD KNOW

Now that you have mastered the operating procedure, here are more features in your control that you should become familiar with.

- The Cool circuit has an automatic 3 minute time delayed start if the unit is turned off and on quickly. This prevents overheating of the compressor and possible circuit breaker tripping. The fan will continue to run during this time.

Fresh Air Vent Control (on some models):



Figure 1 (VENT CLOSED)



Figure 2 (VENT OPEN)

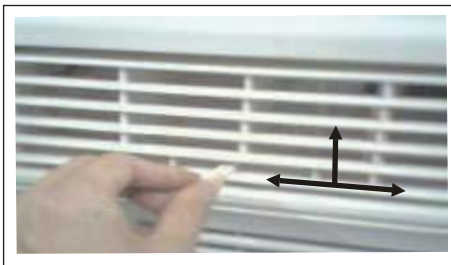

Figure 3 (VENT & EXHAUST OPEN)

The Fresh Air Vent allows the air conditioner to:

1. Recirculate inside air - Vent Closed (See Fig.1)
2. Draw fresh air into the room - Vent Open (see Fig.2)
3. Exchange air from the room and draws fresh air into the room - Vent and Exhaust Open (see Fig.3)

Air Directional Louvers



The 3-way air directional louvers allow you to direct the air flow Up (on some models) and Left or Right throughout the room as needed. To adjust the air directional louvers side-to-side, use the center handles as you move it side-to-side.

INSTALLATION INSTRUCTIONS

Please read ALL instructions before installing. Two people are recommend to install this product. If a new electrical outlet is required, have the outlet installed by a qualified electrician before installing unit.

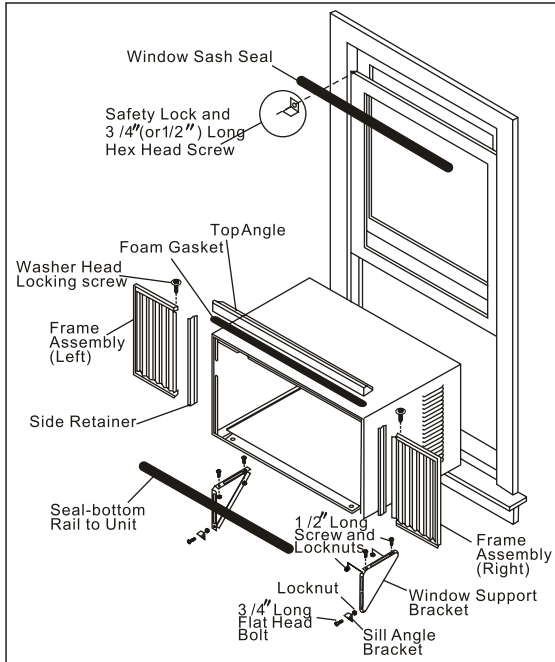

Preliminary Instructions

Do the following before starting to install unit. See illustrations below.

Check dimensions of your unit to determine model type:



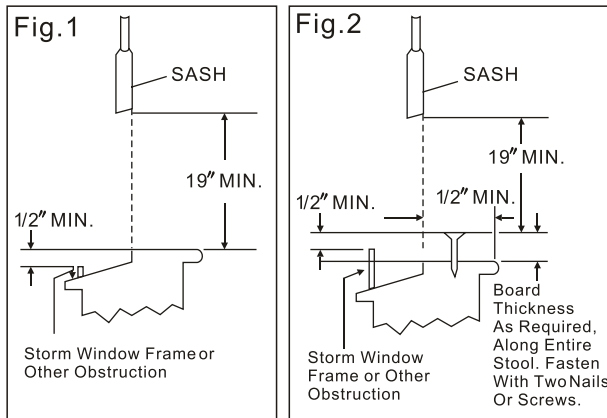

Unit Height:	18 5/8"	17 5/8"
Unit Width:	26 1/2"	23 5/8"
Min. Window Opening:	19 1/2"	18 1/2"
Min. Window Width:	31"	26 1/2"
Max. Window Width:	42"	40 1/2"

- 1. Check window opening size--** the mounting parts furnished with this air conditioner are made to install in a wooden sill double-hung window. The standard parts are for window dimensions listed above. Open sash to a minimum of 19 inches(483mm). See Fig.1.
- 2. Check condition of window--** all wood parts of window must be in good shape and able to firmly hold the needed screws. If not, make repairs before installing unit.
- 3. Check your storm windows--** if your storm window frame does not allow the clearance required, correct by adding a piece of wood as shown in FIG. 2, or by removing storm window while room air conditioner is being installed.
- 4. Check for anything that could block airflow--** check area outside of window for things such as shrubs, trees, or awnings. Inside, be sure furniture, drapes, or blinds will not stop proper airflow.
- 5. Check the available electrical service-** Power supply must be the same as that shown on the unit serial nameplate. Power cord is 48 inches long. Be sure you have an outlet near.
- 6. Carefully unpack air conditioner-** Remove all packing material. Protect floor or carpet from damage. Two people should be used to move and install unit.

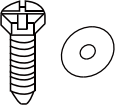

Tools Required

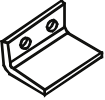
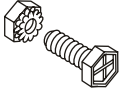
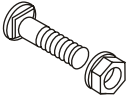
A large flat blade screwdriver
 Tape measure
 Adjustable wrench or pliers
 Pencil
 Level
 Socket wrenches
 Phillips Screwdriver

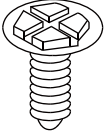
Hardware (Packed with the unit)		
	7/16 inch Locking screw and Flat washer for window panels	2 ea.
	3 / 4 (or 1/2)inch Long Hex-head Screw	4
	Safety Lock	1
	1 / 2 inch Long screw and Locknut	4ea.
	3 / 4 inch Long Flat Head Bolt and Locknut	2ea.
	Sill Angle Bracket	2
	Long hex-head locking screw for top angle, side retainer 5 /16 inch Long	10

Window Mounting

1 Remove Chassis

1. Pull down front panel and remove filter. (See Fig. 1).
2. Lift front upwards and place to one side.
3. Locate the four front screws and remove. These screws will be needed to re-install the front later. (See Fig.2).

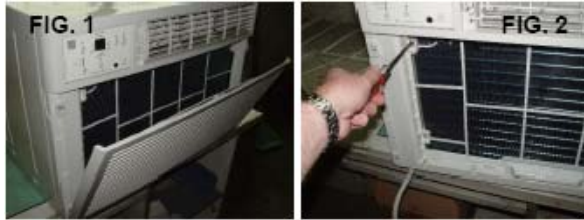

4. Pry away front from cabinet sides as shown in Fig.3 and then disconnect the connector plug of the display panel from the unit (see FIG.3A).
5. Gently lift front off unit and place to one side (see Fig.4).

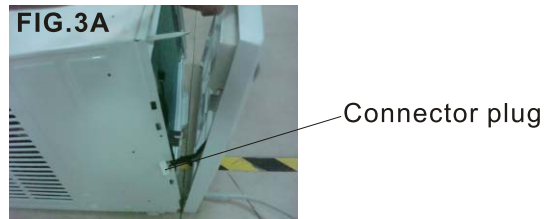

6. Remove shipping screws from top of unit and also on the side by the base if installed.
7. Hold the cabinet while pulling on the base handle, and carefully remove the unit.
8. Add two foam inserts to holes in top of cabinet where shipping screws were removed from.

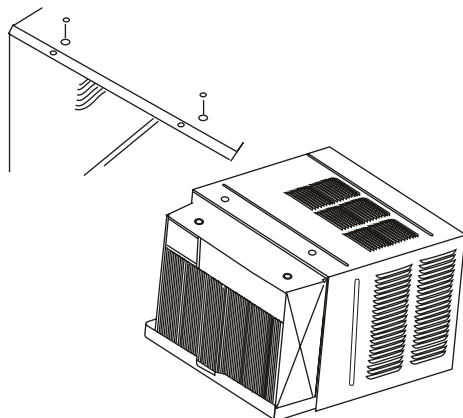

9. Your unit may come with internal packaging. This packaging must be removed prior to installing the air conditioner back into the cabinet. (see Fig.5).



2 Install Top Angle and Side Bracket

1. Attach foam gasket to top angle above holes as shown in Fig.6.
2. Install top angle and side retainers to cabinet as shown in Fig.6.

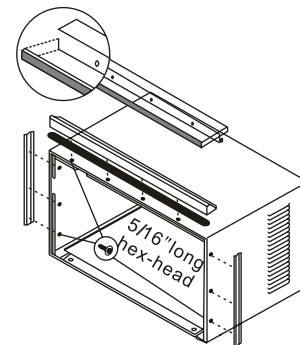

Fig.6

3 Assemble Window Filler Panels

1. Place cabinet on floor, a bench, or a table.
2. Slide "I" section of window filler panel into side retainer on the side of the cabinet (see Fig.7). Do both sides.

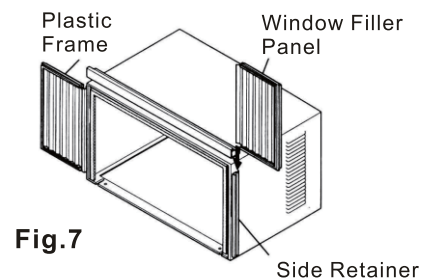
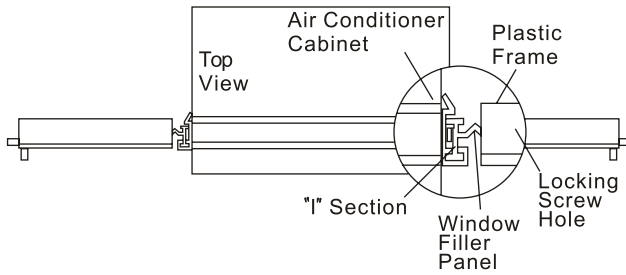

Fig.7



3. Insert top and bottom legs of window filler panel frame into channel in the top angle and bottom rail. Do both sides.
4. Insert washer head locking screws (2) into holes in top leg of filler panel frame (see step 6). Do not totally tighten. Allow leg to slide freely. Screws will be tightened after section 6.

4 Install Top Angle and Side Bracket

1. Open window and mark center of window stool.
2. Place cabinet in window with bottom stool angle firmly seated over window stool as shown. Bring window down temporarily behind top angle to hold cabinet in place.

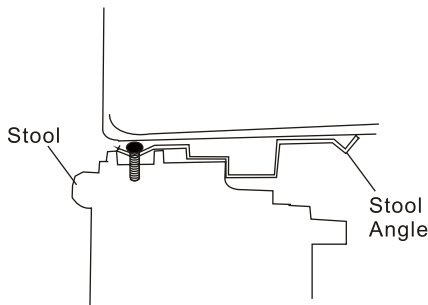
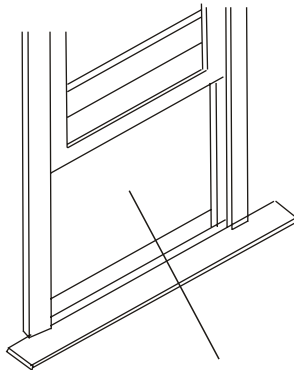

3. Shift cabinet left or right as needed to line up center of cabinet on center line marked on stool.
4. Fasten cabinet to window stool with 2 screws into holes (You may wish to pre-drill pilot holes).
5. Add bottom rail seal over screws to window stool.

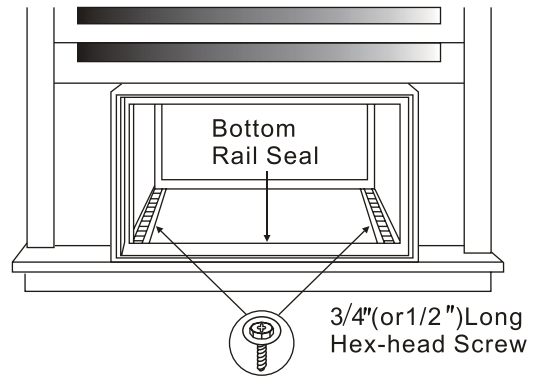

5 Install Support Bracket

1. Hold each support bracket flush against outside of sill, and tight to bottom of cabinet as shown below. Mark brackets at top level of sill, and remove.
2. Assemble sill angle bracket to support brackets at the marked position, as shown. Hand tighten, but allow for any changes later.

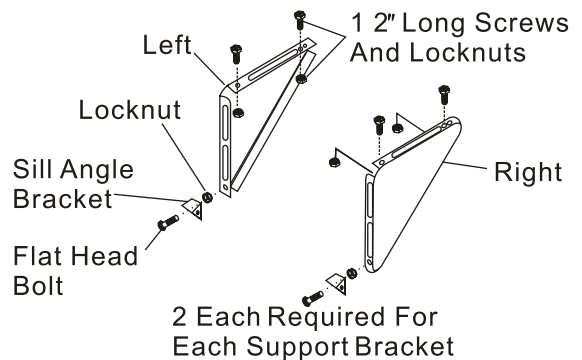
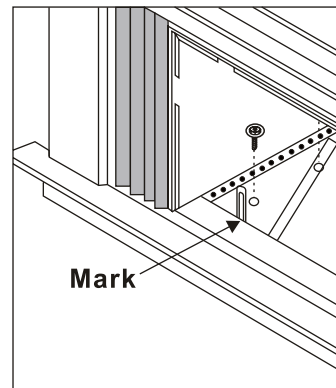

3. Install support brackets (with sill angle brackets attached) to correct hole in bottom of cabinet as shown.
4. Tighten all 6 bolts securely.

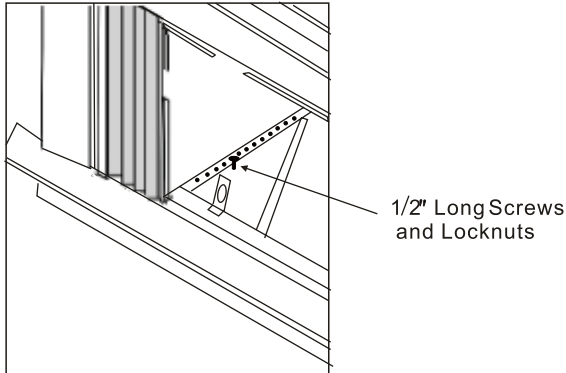

2. Attach right angle safety lock as shown.

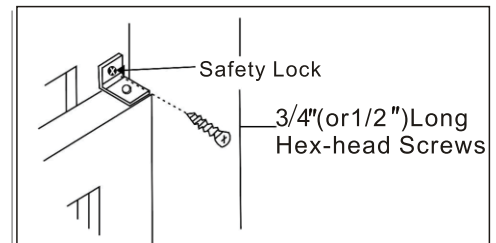

6 *Extend Window Filler Panels*

1. Carefully raise window to expose filler panel locking screws. Loosen screws so filler panels slide easily.
2. Extend panels to fill window opening completely. Tighten locking screws on top.
3. Close window behind top angle.

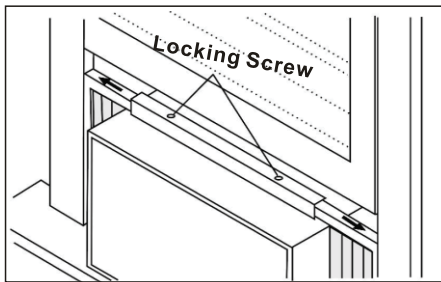

7 *Install Window Lock and Sash Seal*

1. Trim sash seal to fit window width. Insert into space between upper and lower sashes.

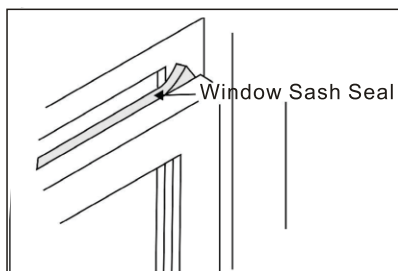

8 *Install Chassis into Cabinet and Install Front to Unit*

1. Lift air conditioner and carefully slide into cabinet leaving 6 inches protruding.
2. DO NOT push on controls or finned coils.
3. Be sure chassis is firmly seated towards rear of cabinet.
4. Installation of front is the reverse of removal outlined in Section 1.

Thru-The-Wall Installation

NOTE: Consult local building codes prior to installation, or a qualified carpenter.

1 Select Wall Location

The air conditioner has a slide-out chassis, so that it can be installed through an outside wall as specified below:

Max. Wall thickness: 12" or 10"

IMPORTANT: Side louvers must never be blocked.

NOTE: All parts needed for Thru-The-Wall Installation are provided, except a wood frame, shims, and 10 wood screws(#10-1" long minimum).

Select a wall surface that:

1. does not support major structural loads such as the frame construction at ends of windows, and under truss-bearing points, etc.
2. does not have plumbing or wiring inside.
3. is near existing electrical outlets, or where another outlet can be installed.
4. faces, and is not blocked to the area to be cooled.
5. allows unblocked airflow from rear sides and end(outside) of installed air conditioner.

2 Prepare Wall

1. Prepare wall in frame construction (including brick and stucco veneer). Working from inside the room, find wall stud nearest the center of area where air conditioner will be installed (by sounding wall, or by magnetically finding nails).
2. Cut or knock out a hole on each side of center stud.
3. Measure between inside edges of every other stud as shown in Fig.1.

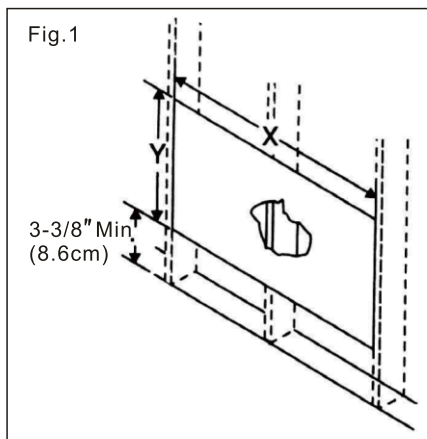

Carefully measure and cut an opening with the following dimensions depending on your model. See Fig.1 and Fig.2.

WIDTH" X"= inside model width plus twice the thickness of framing material used.

HEIGHT" Y" =inside model height plus twice the thickness of framing material used.

Inside Frame Height: 18 7/8"(47.9cm) or 18"(45.7cm)

Inside Frame Width: 26 3/4"(67.9cm) or 23 7/8"(60.6cm)

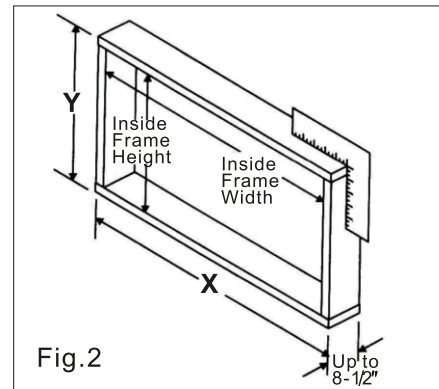

4. Build a wooden frame with the INSIDE dimensions of your model listed above. (Measure twice remember). Frame depth should be the same as wall thickness. Fill in the space from the opening to the studs with wood spacers, as shown.
5. Nail frame to spacers to spacers with front flush with drywall.

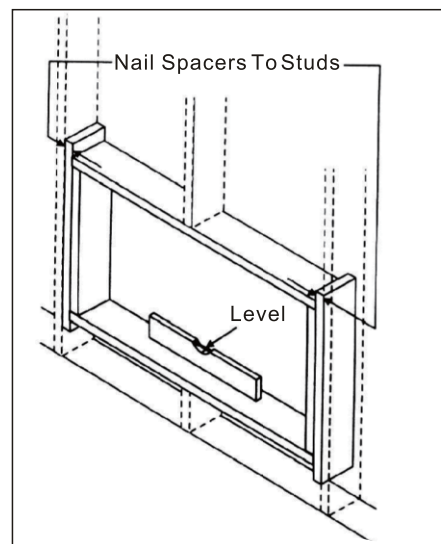

NOTE: If wall thickness is 8-1/2" or more, add aluminum flashing over bottom of frame opening to assure no water can enter area between inner and outer wall.

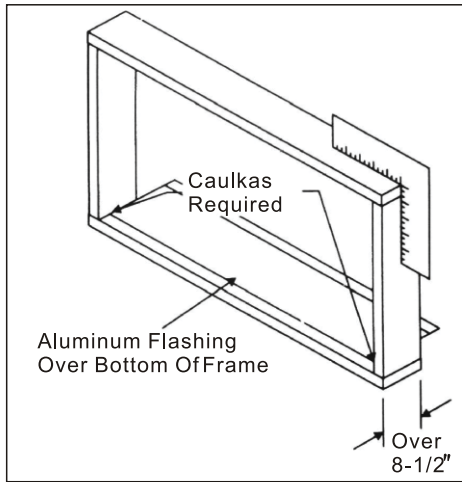

3 Prepare and Install Cabinet

1. Slide chassis from cabinet. Refer back to Step one of Window Mounting.
2. Place cabinet into opening with bottom rail resting firmly on bottom board of wooden frame.
3. Position cabinet to achieve proper slope for water removal. (See Fig.1 below.)

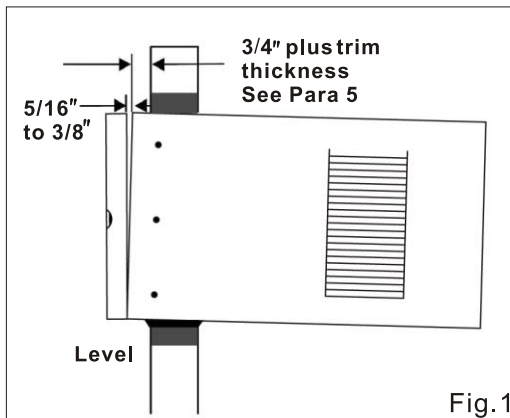

4. Secure bottom rail to wood frame with two large wood screws 1" (2.5cm) long using the two holes in the bottom of the channel resting on frame. (See Fig.2 following).

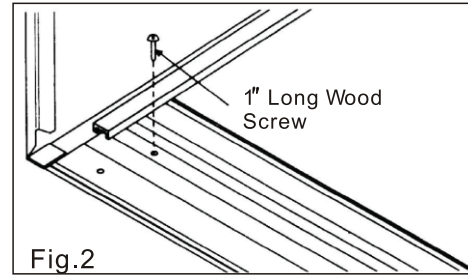
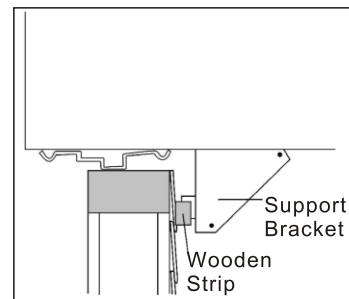
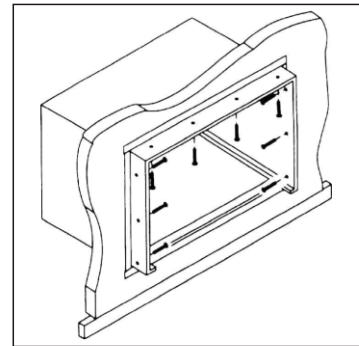

Fig.2

Refer to Step 4 of Window Mounting for assembly of support brackets. A wooden strip nailed to the outside wall should be used in conjunction with sill support angle brackets.



5. Screw or nail cabinet wooden frame using shims if frame is oversized, to eliminate distortion. Remember to maintain proper slope as described in Step 3.



6. Install chassis into cabinet by following all steps in Step 8 of Window Mounting.

OPTIONAL: Caulking and installation of trim on interior wall may be done. You can buy wood from your local lumber or hardware supply. On the outside, caulk openings around top and sides of cabinet, and all sides of wood sleeve to the opening.

NOTE: See Step 7, Item 3 of Window Mounting Instructions for bottom rail seal location.

Masonry Construction

1. Cut or build a wall opening in the masonry wall similar to the frame construction (refer to Step 2 of Thru-the-wall Installation for a wall thickness greater than 8-1/2').
2. Secure cabinet in place using masonry nails, or the right masonry anchor screws. (Another way to do this is to build an in-between frame of 2x4's as shown in the Step 2 Prepare Wall illustrations-but make it double framed on either side, and install between masonry wall opening and cabinet. Frame must be securely anchored to masonry wall opening). This way gives very good louver clearance on either side of cabinet.
3. Install a lintel to support masonry wall above cabinet. Existing holes in cabinet can be used and/ or additional holes can be drilled to fasten cabinet at various positions. Be sure that side louver clearance is in accordance with Step 1 above.
4. Install exterior cabinet support brackets as shown in Step 2 of Thru-the-wall installation. Caulk or flash if needed, to provide a weather-tight seal around top and sides of cabinet.
5. To complete installation, apply wood trim molding around room side projection of cabinet.

CARE AND CLEANING

WARNING

Clean your air conditioner occasionally to keep it looking new. **Be sure to unplug the unit before cleaning to prevent shock or fire hazards.**

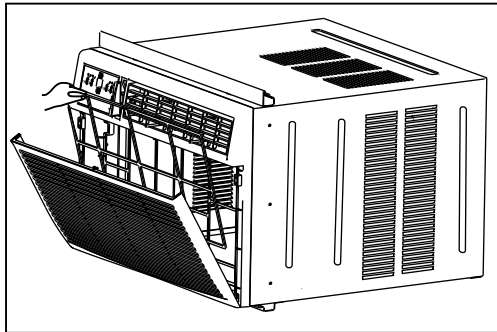

Air Filter Cleaning

The air filter should be checked at least once a month to see if cleaning is necessary. Trapped particles in the filter can build up and cause an accumulation of frost on the cooling coils.

- Push the vent handle to the Vent Closed position (where applicable).
- Open the front panel.
- Grasp the filter, pull up and out.
- Wash the filter using liquid dishwashing detergent and warm water. Rinse filter thoroughly.
- Gently shake excess water from the filter. Be sure the filter is thoroughly dry before replacing.
- Or, instead of washing you may vacuum the filter clean.

Note: Never use hot water over 104°F (40°C) to clean the air filter. Never attempt to operate the unit without the air filter.

Cabinet Cleaning

- Be sure to unplug the air conditioner to prevent shock or fire hazard. The cabinet and front may be dusted with an oil-free cloth or washed with a cloth dampened in a solution of warm water and mild liquid dishwashing detergent. Rinse thoroughly and wipe dry.
- Never use harsh cleaners, wax or polish on the cabinet front.
- Be sure to wring excess water from the cloth before wiping around the controls. Excess water in or around the controls may cause damage to the air conditioner.
- Plug in air conditioner.

Winter Storage

If you plan to store the air conditioner during the winter, remove it carefully from the window according to the installation instructions. Cover it with plastic or return it to the original carton.

TROUBLESHOOTING TIPS

Before calling for service, review this list. It may save you time and expense. This list includes common occurrences that are not the result of defective workman-ship or materials in this appliance.

Problem	Solution
Air conditioner does not start	<i>Wall plug disconnected. Push plug firmly into wall outlet.</i>
	<i>House fuse blown or circuit breaker tripped. Replace fuse with time delay type or reset circuit breaker.</i>
	<i>Plug Current Device Tripped. Press the RESET button.</i>
	<i>Control is OFF. Turn Control ON and set to desired setting.</i>
Air from unit does not feel cold enough	<i>Room temperature below 62°F (17°C). Cooling may not occur until room temperature rises above 62°F (17°C).</i>
	<i>Temperature sensing element touching cold coil, located behind air filter. Straighten tube away from coil.</i>
	<i>Reset to a Lower temperature.</i>
	<i>Compressor shut-off by changing modes. Wait approximately 3 minutes and listen for compressor to restart when set in the COOL mode.</i>
Air conditioner cooling, but room is too warm- ice forming on cooling coil behind decorative front.	<i>Outdoor temperature below 64°F (18°C). To defrost the coil, set FAN ONLY mode.</i>
	<i>Air filter may be dirty. Clean filter. Refer to Care and Cleaning section. To defrost, set to FAN ONLY mode.</i>
	<i>Thermostat set too cold for night-time cooling. To defrost the coil, set to FAN ONLY mode. Then, set temperature to a Higher setting.</i>
Air conditioner cooling, but room is too warm- NO ice forming on cooling coil behind decorative front.	<i>Dirty air filter- air restricted. Clean air filter. Refer to Care and Cleaning section.</i>
	<i>Temperature is set too High, set temperature to a Lower setting.</i>
	<i>Air directional louvers positioned improperly. Position louvers for better air distribution.</i>
	<i>Front of units is blocked by drapes, blinds, furniture, etc. - restricts air distribution. Clear blockage in front of unit.</i>
	<i>Doors, windows, registers, etc. Open- cold air escapes. Close doors, windows, registers.</i>
	<i>Unit recently turned on in hot room. Allow additional time to remove " Stored heat " from walls, ceiling, floor and furniture.</i>
Air conditioner turns on and off rapidly	<i>Dirty air filter- air restricted. Clean air filter.</i>
	<i>Outside temperature extremely hot. Set FAN speed to a Higher setting to bring air past cooling coils more frequently.</i>
Noise when unit is cooling	<i>Air movement sound. This is normal . If too loud, set to a slower FAN setting.</i>
	<i>Window vibration - poor installation. Refer to installation instructions or check with installer.</i>
Water dripping INSIDE when unit is cooling.	<i>Improper installation. Tilt air conditioner slightly to the the rear/outside to allow water drainage. Refer to installation instructions - check with installer.</i>

Problem	Solution
Water dripping OUTSIDE when unit is cooling.	<i>Unit removing large quantity of moisture from humid room. This is normal during excessively humid days.</i>
Remote Sensing Deactivating Prematurely (some models)	<i>Remote control not located within range. Place remote control within 20 feet & 180°, radius of the front of the unit.</i> <i>Remote control signal obstructed. Remove obstruction.</i>
Room too cold	<i>Set temperature too low. Increase set temperature.</i>

Design, material, performance data and components
subject to change without notice.

HEAT CONTROLLER, INC.

1900 Wellworth Ave., Jackson, MI 49203 ♦ Ph. 517-787-2100 ♦ Fax 517-787-9341

THE QUALITY LEADER IN CONDITIONING AIR

www.heatcontroller.com

12/2009

Free Manuals Download Website

<http://myh66.com>

<http://usermanuals.us>

<http://www.somanuals.com>

<http://www.4manuals.cc>

<http://www.manual-lib.com>

<http://www.404manual.com>

<http://www.luxmanual.com>

<http://aubethermostatmanual.com>

Golf course search by state

<http://golfingnear.com>

Email search by domain

<http://emailbydomain.com>

Auto manuals search

<http://auto.somanuals.com>

TV manuals search

<http://tv.somanuals.com>