



Voice Evacuation Control Panels
AUDIO·COMMAND·CENTER·25/50
AUDIO·COMMAND·CENTER·25/50ZS
AUDIO·COMMAND·CENTER·25/50ZST
Instruction Manual

Document 51889	E1
6/8/2010 Rev:	
<small>P/N 51889:E1</small>	<small>ECN 10-278</small>

Fire Alarm System Limitations

While a fire alarm system may lower insurance rates, it is not a substitute for fire insurance!

An automatic fire alarm system—typically made up of smoke detectors, heat detectors, manual pull stations, audible warning devices, and a fire alarm control panel with remote notification capability—can provide early warning of a developing fire. Such a system, however, does not assure protection against property damage or loss of life resulting from a fire.

The Manufacturer recommends that smoke and/or heat detectors be located throughout a protected premise following the recommendations of the National Fire Protection Association Standard 72 (NFPA 72), manufacturer's recommendations, State and local codes, and the recommendations contained in the Guides for Proper Use of System Smoke Detectors, which are made available at no charge to all installing dealers. These documents can be found at <http://www.systemsensor.com/html/applicat.html>. A study by the Federal Emergency Management Agency (an agency of the United States government) indicated that smoke detectors may not go off in as many as 35% of all fires. While fire alarm systems are designed to provide early warning against fire, they do not guarantee warning or protection against fire. A fire alarm system may not provide timely or adequate warning, or simply may not function, for a variety of reasons:

Smoke detectors may not sense fire where smoke cannot reach the detectors such as in chimneys, in or behind walls, on roofs, or on the other side of closed doors. Smoke detectors also may not sense a fire on another level or floor of a building. A second-floor detector, for example, may not sense a first-floor or basement fire.

Particles of combustion or "smoke" from a developing fire may not reach the sensing chambers of smoke detectors because:

- Barriers such as closed or partially closed doors, walls, or chimneys may inhibit particle or smoke flow.
- Smoke particles may become "cold," stratify, and not reach the ceiling or upper walls where detectors are located.
- Smoke particles may be blown away from detectors by air outlets.
- Smoke particles may be drawn into air returns before reaching the detector.

The amount of "smoke" present may be insufficient to alarm smoke detectors. Smoke detectors are designed to alarm at various levels of smoke density. If such density levels are not created by a developing fire at the location of detectors, the detectors will not go into alarm.

Smoke detectors, even when working properly, have sensing limitations. Detectors that have photoelectronic sensing chambers tend to detect smoldering fires better than flaming fires, which have little visible smoke. Detectors that have ionizing-type sensing chambers tend to detect fast-flaming fires better than smoldering fires. Because fires develop in different ways and are often unpredictable in their growth, neither type of detector is necessarily best and a given type of detector may not provide adequate warning of a fire.

Smoke detectors cannot be expected to provide adequate warning of fires caused by arson, children playing with matches (especially in bedrooms), smoking in bed, and violent explosions (caused by escaping gas, improper storage of flammable materials, etc.).

Heat detectors do not sense particles of combustion and alarm only when heat on their sensors increases at a predetermined rate or reaches a predetermined level. Rate-of-rise heat detectors may be subject to reduced sensitivity over time. For this reason, the rate-of-rise feature of each detector should be tested at least once per year by a qualified fire protection specialist. Heat detectors are designed to protect property, not life.

IMPORTANT! Smoke detectors must be installed in the same room as the control panel and in rooms used by the system for the connection of alarm transmission wiring, communications, signaling, and/or power. If detectors are not so located, a developing fire may damage the alarm system, crippling its ability to report a fire.

Audible warning devices such as bells may not alert people if these devices are located on the other side of closed or partly open doors or are located on another floor of a building. Any warning device may fail to alert people with a disability or those who have recently consumed drugs, alcohol or medication. Please note that:

- Strobes can, under certain circumstances, cause seizures in people with conditions such as epilepsy.
- Studies have shown that certain people, even when they hear a fire alarm signal, do not respond or comprehend the meaning of the signal. It is the property owner's responsibility to conduct fire drills and other training exercise to make people aware of fire alarm signals and instruct them on the proper reaction to alarm signals.
- In rare instances, the sounding of a warning device can cause temporary or permanent hearing loss.

A fire alarm system will not operate without any electrical power. If AC power fails, the system will operate from standby batteries only for a specified time and only if the batteries have been properly maintained and replaced regularly.

Equipment used in the system may not be technically compatible with the control panel. It is essential to use only equipment listed for service with your control panel.

Telephone lines needed to transmit alarm signals from a premise to a central monitoring station may be out of service or temporarily disabled. For added protection against telephone line failure, backup radio transmission systems are recommended.

The most common cause of fire alarm malfunction is inadequate maintenance. To keep the entire fire alarm system in excellent working order, ongoing maintenance is required per the manufacturer's recommendations, and UL and NFPA standards. At a minimum, the requirements of NFPA 72 shall be followed. Environments with large amounts of dust, dirt or high air velocity require more frequent maintenance. A maintenance agreement should be arranged through the local manufacturer's representative. Maintenance should be scheduled monthly or as required by National and/or local fire codes and should be performed by authorized professional fire alarm installers only. Adequate written records of all inspections should be kept.

Limit-C1-2-2007

Installation Precautions

Adherence to the following will aid in problem-free installation with long-term reliability:

WARNING - Several different sources of power can be connected to the fire alarm control panel. Disconnect all sources of power before servicing. Control unit and associated equipment may be damaged by removing and/or inserting cards, modules, or interconnecting cables while the unit is energized. Do not attempt to install, service, or operate this unit until manuals are read and understood.

CAUTION - System Re-acceptance Test after Software Changes: To ensure proper system operation, this product must be tested in accordance with NFPA 72 after any programming operation or change in site-specific software. Re-acceptance testing is required after any change, addition or deletion of system components, or after any modification, repair or adjustment to system hardware or wiring. All components, circuits, system operations, or software functions known to be affected by a change must be 100% tested. In addition, to ensure that other operations are not inadvertently affected, at least 10% of initiating devices that are not directly affected by the change, up to a maximum of 50 devices, must also be tested and proper system operation verified.

This system meets NFPA requirements for operation at 0-49° C/32-120° F and at a relative humidity 93% ± 2% RH (non-condensing) at 32°C ± 2°C (90°F ± 3°F). However, the useful life of the system's standby batteries and the electronic components may be adversely affected by extreme temperature ranges and humidity. Therefore, it is recommended that this system and its peripherals be installed in an environment with a normal room temperature of 15-27° C/60-80° F.

Verify that wire sizes are adequate for all initiating and indicating device loops. Most devices cannot tolerate more than a 10% I.R. drop from the specified device voltage.

Like all solid state electronic devices, this system may operate erratically or can be damaged when subjected to lightning induced transients. Although no system is completely immune from lightning transients and interference, proper grounding will reduce susceptibility. Overhead or outside aerial wiring is not recommended, due to an increased susceptibility to nearby lightning strikes. Consult with the Technical Services Department if any problems are anticipated or encountered.

Disconnect AC power and batteries prior to removing or inserting circuit boards. Failure to do so can damage circuits.

Remove all electronic assemblies prior to any drilling, filing, reaming, or punching of the enclosure. When possible, make all cable entries from the sides or rear. Before making modifications, verify that they will not interfere with battery, transformer, or printed circuit board location.

Do not tighten screw terminals more than 9 in-lbs. Overtightening may damage threads, resulting in reduced terminal contact pressure and difficulty with screw terminal removal.

This system contains static-sensitive components. Always ground yourself with a proper wrist strap before handling any circuits so that static charges are removed from the body. Use static suppressive packaging to protect electronic assemblies removed from the unit.

Follow the instructions in the installation, operating, and programming manuals. These instructions must be followed to avoid damage to the control panel and associated equipment. FACP operation and reliability depend upon proper installation.

Precau-D1-9-2005

FCC Warning

WARNING: This equipment generates, uses, and can radiate radio frequency energy and if not installed and used in accordance with the instruction manual may cause interference to radio communications. It has been tested and found to comply with the limits for class A computing devices pursuant to Subpart B of Part 15 of FCC Rules, which is designed to provide reasonable protection against such interference when devices are operated in a commercial environment. Operation of this equipment in a residential area is likely to cause interference, in which case the user will be required to correct the interference at his or her own expense.

Canadian Requirements

This digital apparatus does not exceed the Class A limits for radiation noise emissions from digital apparatus set out in the Radio Interference Regulations of the Canadian Department of Communications.

Le present appareil numerique n'emet pas de bruits radioelectriques dépassant les limites applicables aux appareils numeriques de la classe A prescrites dans le Reglement sur le brouillage radioelectrique edicte par le ministere des Communications du Canada.

LiteSpeed™ is a trademark; and FireLite® Alarms is a registered trademark of Honeywell International Inc. Microsoft® and Windows® are registered trademarks of the Microsoft Corporation.

©Tuesday, August 14, 2012 9:40 am by Honeywell International Inc. All rights reserved. Unauthorized use of this document is strictly prohibited.

Software Downloads

In order to supply the latest features and functionality in fire alarm and life safety technology to our customers, we make frequent upgrades to the embedded software in our products. To ensure that you are installing and programming the latest features, we strongly recommend that you download the most current version of software for each product prior to commissioning any system. Contact Technical Support with any questions about software and the appropriate version for a specific application.

Documentation Feedback

Your feedback helps us keep our documentation up-to-date and accurate. If you have any comments or suggestions about our online Help or printed manuals, you can email us.

Please include the following information:

- Product name and version number (if applicable)
- Printed manual or online Help
- Topic Title (for online Help)
- Page number (for printed manual)
- Brief description of content you think should be improved or corrected
- Your suggestion for how to correct/improve documentation

Send email messages to:

FireSystems.TechPubs@honeywell.com

Please note this email address is for documentation feedback only. If you have any technical issues, please contact Technical Services.

Table of Contents

Section 1: Product Description	13
1.1: Product Features	14
1.2: Specifications.....	19
1.3: Controls and Indicators.....	23
1.3.1: Single Zone Operation (ACC-25/50, ACC-25/50ZS, ACC-25/50ZST)	23
1.3.2: Dual Zone Operation (ACC-25/50 Only).....	23
1.3.3: RECORD/PLAYBACK	24
1.3.4: TROUBLE SILENCE	24
1.3.5: LEDs (visible with panel door closed):	24
1.3.6: ACC-ZPMK Zone Page Module (ACC-25/50ZS and ACC-25/50ZST Panels <i>only</i>)	24
1.3.7: ACC-FFT Fire Fighter Telephone Module (<i>ACC-25/50ZST only</i>)	25
1.3.8: ACC-EPM External Page Module.....	25
1.3.9: Other System LEDs (located on main circuit board and modules)	25
1.4: Circuits.....	26
1.5: Components	27
1.6: Optional Modules	29
1.7: Getting Started	30
1.7.1: ACC-25/50, Requiring up to 50 Watts of Audio Power.....	30
1.7.2: ACC-25/50 With ACC-25/50DA(s), Requiring Greater Than 50 Watts of Audio Power.....	30
1.7.3: ACC-25/50ZS & ACC-25/50ZST, Requiring up to 50 Watts of Audio Power.....	30
1.7.4: ACC-25/50ZS & ACC-25/50ZST, Requiring Greater Than 50 Watts But Less Than 150 Watts....	31
Section 2: Field Programming.....	32
2.1: S1 DIP Switch Settings on ACC-25/50 Series Motherboard (ACC-MCB)	36
2.2: S5 DIP Switch Settings on ACC-25/50 Series Motherboard (ACC-MCB)	37
2.3: S3 DIP Switch Settings on ACC-25/50 Motherboard (ACC-MCB)	37
2.4: S2 - Record Bypass Switch on ACC-25/50 Series Motherboard (ACC-MCB)	38
2.5: S4 - Battery Charger Switch on ACC-25/50 Series Motherboard.....	39
2.6: SW1 - Remote Microphone Installed Switch on ACC-FFT.....	39
2.7: SW2 - 2 Wire/4 Wire Connection on Telephone Loop.....	39
2.8: ACC-ZPMK Zone Page Module (ACC-25/50ZS & ACC-25/50ZST)	39
2.8.1: S1 DIP Switch Settings on ACC-ZPMK.....	40
2.8.2: S2 and S3 Addressing Rotary Switches	41
2.9: ACC-ZSM Zone Splitter Module (ACC-25/50ZS & ACC-25/50ZST)	41
Section 3: Installation.....	42
3.1: Mounting Options	42
3.2: Backbox Installation	42
3.2.1: Transformer Installation	45
3.3: Operating Power	46
3.4: Auxiliary DC Power Output Connections	48
3.5: Input/Initiating Circuits	48
3.6: Output Circuits.....	49
3.6.1: Master Command Bus Output	49
3.6.2: Trouble Relay - TB1	51
3.6.3: AC Power Loss Relay - TB7	51
3.6.4: Notification Appliance Circuit (Speakers)	51
3.6.5: ACC-ZPMK Zone Page Module - ACS Link (ACC-25/50ZS & ACC-25/50ZST)	52
3.6.6: ACC-ZSM Zone Splitter Module (ACC-25/50ZS & ACC-25/50ZST)	54
3.6.7: ACC-FFT Fire Fighter Telephone Module (<i>ACC-25/50ZST Only</i>)	55
3.7: UL Power-limited Wiring Requirements.....	56
3.8: Installation of Option Modules.....	57
3.8.1: Audio Amplifier Module (ACC-AAM25)	57
3.8.2: 70.7 V _{RMS} Transformer Module (FC-XRM70)	58
3.8.3: Local Playback Speaker Module (FC-LPS)	59

3.8.4: ACC-EPM External Page Module.....	60
Section 4: Operating Instructions	63
4.1: Switch Functions.....	63
4.1.1: Single Zone Operation (ACC-25/50, ACC-25/50ZS, ACC-25/50ZST)	63
4.1.2: Dual Zone Operation (ACC-25/50 Only)	63
4.1.3: RECORD/PLAYBACK	64
4.1.4: TROUBLE SILENCE	64
4.1.5: Record/Playback Button - Record Customized Messages.....	64
Recording Instructions.....	64
4.1.6: Record/Playback Button - Review Stored Message(s).....	65
4.1.7: Main Control Panel Keypad Labels.....	66
4.2: ACC-ZPMK Switch Functions (ACC-25/50ZS & ACC-25/50ZST).....	66
4.3: ACC-FFT Answer Call Push-Button (ACC-25/50ZST).....	67
4.4: LED Indicators.....	67
4.4.1: LEDs Visible with Backbox Door Closed (Figure 4.1 on page 63)	67
4.4.2: ACC-ZMPK LEDs Visible with Backbox Door Closed (Figure 4.4 on page 66)	68
4.4.3: ACC-FFT LEDs Visible with Backbox Door Closed (Figure 3.15 on page 55).....	69
4.4.4: LEDs Visible with Door Open and Optional Dress Panel Removed (Figure 1.1 & Figure 1.2).....	69
4.5: Operation.....	70
4.5.1: Fire Alarm.....	70
4.5.2: Fire Alarm Restoral	70
4.5.3: Manual Evacuation/Alert.....	70
4.5.4: Manual Evacuation/Alert Restoral	71
4.5.5: Audio On/Off: ACC-25/50 Single Zone and ACC-25/50ZS/T	71
4.5.6: All Call: ACC-25/50, Single Zone Configuration.....	71
All-Call General Page Using Local Microphone.....	72
All-Call General Page Using Optional Remote Microphone	72
All-Call Emergency Page Using Local Microphone.....	72
All-Call Emergency Page Using Optional Remote Microphone.....	72
All-Call During FACP Activated Alarm	72
All-Call During Manual Evacuation/Alert	72
All-Call With Distributed Audio Panels.....	72
4.5.7: All-Call: ACC-25/50ZS & ACC-25/50ZST	72
All-Call General Page Using Local/Integral Microphone	72
All-Call General Page Using Optional Remote Microphone	73
All-Call General Page Using Optional RPJ-F Remote Keyswitch via the Optional Fire Fighter Telephone Module:.....	73
All-Call Emergency Page Using Local/Integral Microphone	73
All-Call Emergency Page Using Optional Remote Microphone.....	73
All-Call Emergency Page Using Optional RPJ-F Remote Keyswitch via the Fire Fighter Telephone Module.....	73
All-Call During FACP Activated Alarm	73
All-Call During Manual Evacuation/Alert	73
4.5.8: Paging: ACC-25/50 Single Zone	73
General Page Using Local/Integral Microphone	73
General Page Using Optional Remote Microphone	73
Emergency Page Using Local/Integral Microphone.....	74
Emergency Page Using Optional Remote Microphone.....	74
4.5.9: Paging: ACC-25/50 Dual Zone	74
General Page Using Local/Integral Microphone	74
General Page Using Optional Remote Microphone	74
Emergency Page Using Local/Integral Microphone.....	74
Emergency Page Using Optional Remote Microphone.....	74
4.5.10: Paging: ACC-25/50ZS & ACC-25/50ZST	74
General Page Using Local/Integral Microphone	74
General Page Using Optional Remote Microphone	75

General Page Using the Optional RPJ-F Remote Keyswitch via the Optional Fire Fighter Telephone Module.....	75
Emergency Page Using Local/Integral Microphone	75
Emergency Page Using Optional Remote Microphone.....	75
Emergency Page Using Optional RPJ-F Remote Keyswitch via the Optional Fire Fighter Telephone Module.....	75
4.5.11: Fire Fighter Telephone: ACC-25/50ZST Only	75
Communication on the Telephone Loop	75
Annunciation of Remote Telephone Locations (MS-9600 or MS-9200UDLS only)	76
4.5.12: Trouble Condition Response	76
4.5.13: Trouble Condition Restoral	78
Section 5: Application Examples	80
5.1: One Speaker Circuit on ACC-25/50	80
5.2: One Speaker Circuit With Backup on ACC-25/50	81
5.3: Two Speaker Circuits on ACC-25/50	83
5.4: Two Speaker Circuits on ACC-25/50	85
5.5: ACC-25/50ZS & ACC-25/50ZST Zone Splitting Applications.....	87
5.5.1: 25 Watt Zone Splitting - Eight Speaker Circuits, Style Y (Class B).....	87
5.5.2: 25 Watt Zone Splitting - Four Speaker Circuits, Style Z (Class A)	89
5.5.3: 50 Watt Zone Splitting - Eight Speaker Circuits.....	91
5.6: ACC-25/50 and ACC-25/50DA Installation	93
5.7: 16 Theater Cineplex Utilizing ACC-25/50ZS With ACC-25/50DAZS	95
5.8: Audio Command Center 24 Zone System.....	96
Section 6: Power Supply Calculations.....	98
6.1: Overview.....	98
6.2: Calculating the AC Branch Circuit.....	98
6.3: Calculating the System Current Draw	98
6.3.1: Overview	98
6.3.2: How to use Table 6.2 to calculate system current draws.....	99
6.4: Calculating the Battery Size	100
6.4.1: NFPA Battery Requirements.....	100
6.4.2: Selecting and Locating Batteries	100
Appendix A: Digital Voice Messages	102
Appendix B: Addressable Module Connections.....	103
Appendix C: Wiring Requirements.....	104
Appendix D: Programmed Activation by FACP	105
D.1: MS-9600, MS-9200UDLS and MS-9200UD	106
D.1.1: Overview.....	106
D.1.2: Basic MS-9600/MS-9200UD/MS-9200UDLS & ACC-25/50ZS/T Step-By-Step Install/Setup... 106	
D.1.3: Wiring From ACC-25/50ZS or ACC-25/50ZST to FACP.....	107
D.1.4: ACC-25/50ZS and ACC-25/50ZST Switch Settings	108
D.1.5: FACP Programming	109
Programming Tips for MS-9600, MS-9600LD, MS-9200UDLS, and MS-9200UD.....	110
Message Assignment - Speaker Specific.....	110
Message Assignment - Zone Specific	112
Fire Fighter Telephone SLC Point Assignment	115
D.2: MS-5210UD.....	118
D.2.1: Overview.....	118
D.2.2: MS-5210UD Individual Zone Control With One or Two Messages.....	118
ACC-25/50ZS/T DIP Switch Settings.....	119
MS-5210UD Programming	120
D.2.3: MS-5210UD All Zone Activation With One to Five Messages.....	120
ACC-25/50ZS and ACC-25/50ZST Switch Settings	121

ACM-8RF Programming	121
MS-5210UD Programming	121
D.3: MS-9200(E)	122
D.3.1: Overview	122
D.3.2: Basic MS-9200 & ACC-25/50ZS/T Step-By-Step Install/Setup	122
D.3.3: Wiring From ACC-25/50ZS or ACC-25/50ZST to MS-9200(E).....	124
ACC-25/50ZS & ACC-25/50ZST Switch Settings	125
D.3.4: FACP Programming	125
D.4: MS-5UD-3/7 and MS-10UD-3/7	127
D.4.1: Overview	127
D.4.2: Basic ANN-BUS Step-By-Step Install/Setup	127
D.4.3: ACC-ZPMK DIP Switch 1 Settings on ACC-25/50ZS and ACC-25/50ZST	128
D.4.4: Wiring From ACC-25/50ZS or ACC-25/50ZST to FACP	129
D.4.5: FACP Programming	130
Index	138

This control panel has been designed to comply with standards set forth by the following regulatory agencies:

- Underwriters Laboratories Standard UL 864
- NFPA 72 National Fire Alarm Code



NFPA Standards

This Fire Alarm Control Panel complies with the following NFPA Standards:

NFPA 72 National Fire Alarm Code

Note: Audible signal appliances used in public mode applications, are required to have minimum sound levels of 75 dBA at 10 feet (3 meters) and a maximum level of 120 dBA at the minimum hearing distance from the audible appliance.

To ensure that the appliance is clearly heard, the audible appliance sound level must be at least 15 dBA above the average ambient sound level or 5 dBA above the maximum sound level with a duration of at least 60 seconds, depending on which level is greater, with the sound level being measured 5 feet (1.5 meters) above the floor.



Underwriters Laboratories Documents:

UL 38 Manually Actuated Signaling Boxes

UL 217 Smoke Detectors, Single and Multiple Station

UL 228 Door Closers–Holders for Fire Protective Signaling Systems

UL 268 Smoke Detectors for Fire Protective Signaling Systems

UL 268A Smoke Detectors for Duct Applications

UL 346 Waterflow Indicators for Fire Protective Signaling Systems

UL 464 Audible Signaling Appliances

UL 521 Heat Detectors for Fire Protective Signaling Systems

UL 864 Standard for Control Units for Fire Protective Signaling Systems

UL 1481 Power Supplies for Fire Protective Signaling Systems

UL 1638 Visual Signaling Appliances

UL 1711 Amplifiers for Fire Protective Signaling Systems

UL 1971 Signaling Devices for Hearing Impaired

Other:

NEC Article 250 Grounding

NEC Article 300 Wiring Methods

NEC Article 760 Fire Protective Signaling Systems

Applicable Local and State Building Codes

Requirements of the Local Authority Having Jurisdiction (LAHJ)

Fire•Lite Documents

Fire•Lite Device Compatibility Document Document #15384

MS-5UD/10UD Series Technical Manual Document #52626

FCPS-24F(E) Field Charger/Power Supply Document #50079

FCPS-2404 Field Charger/Power Supply Document #51486

FCPS-24FS6/8 Field Charger/Power Supply Document #51883

MS-9200(C/E) Technical Manual Document #51003

MS-9200UD Technical Manual Document #51906

MS-9200UDLS Technical Manual Document #52750

MS-9600 Technical Manual Document #51335

MS-5210UD Technical Manual Document #50193

ACC-25/50DA Technical Manual Document #52265

SLC Wiring Manual Document #51309

This product has been certified to comply with the requirements in the Standard for Control Units and Accessories for Fire Alarm Systems, UL 864, 9th Edition. Operation of this product with products not tested for UL 864, 9th Edition has not been evaluated. Such operation requires the approval of the local Authority Having Jurisdiction (AHJ).

ACC-25/50 System Audio Command Center System Diagram

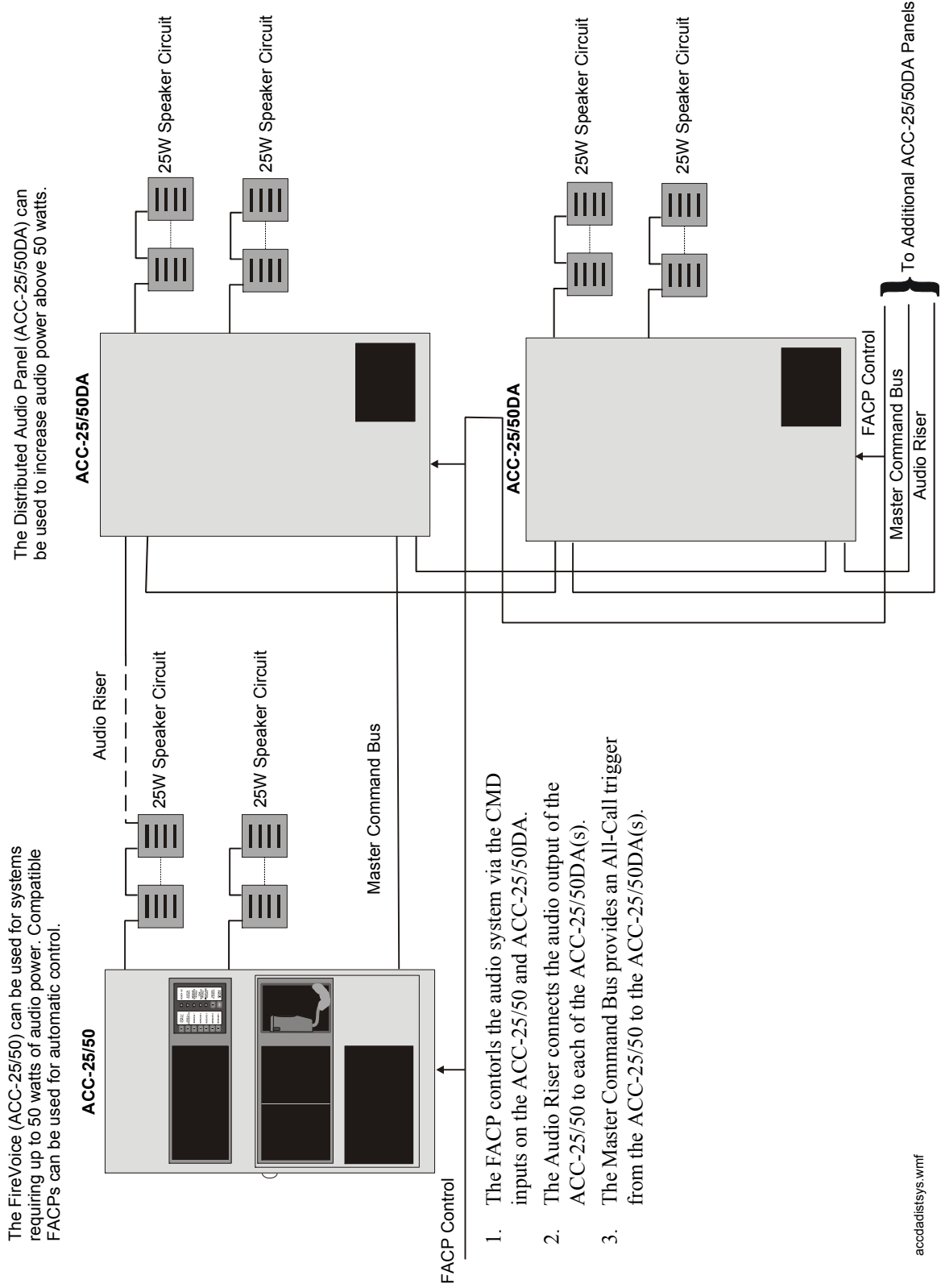

accdadistsys.wmf

Audio Command Center Zone System Up to 24 Zones @ 150W (max.)

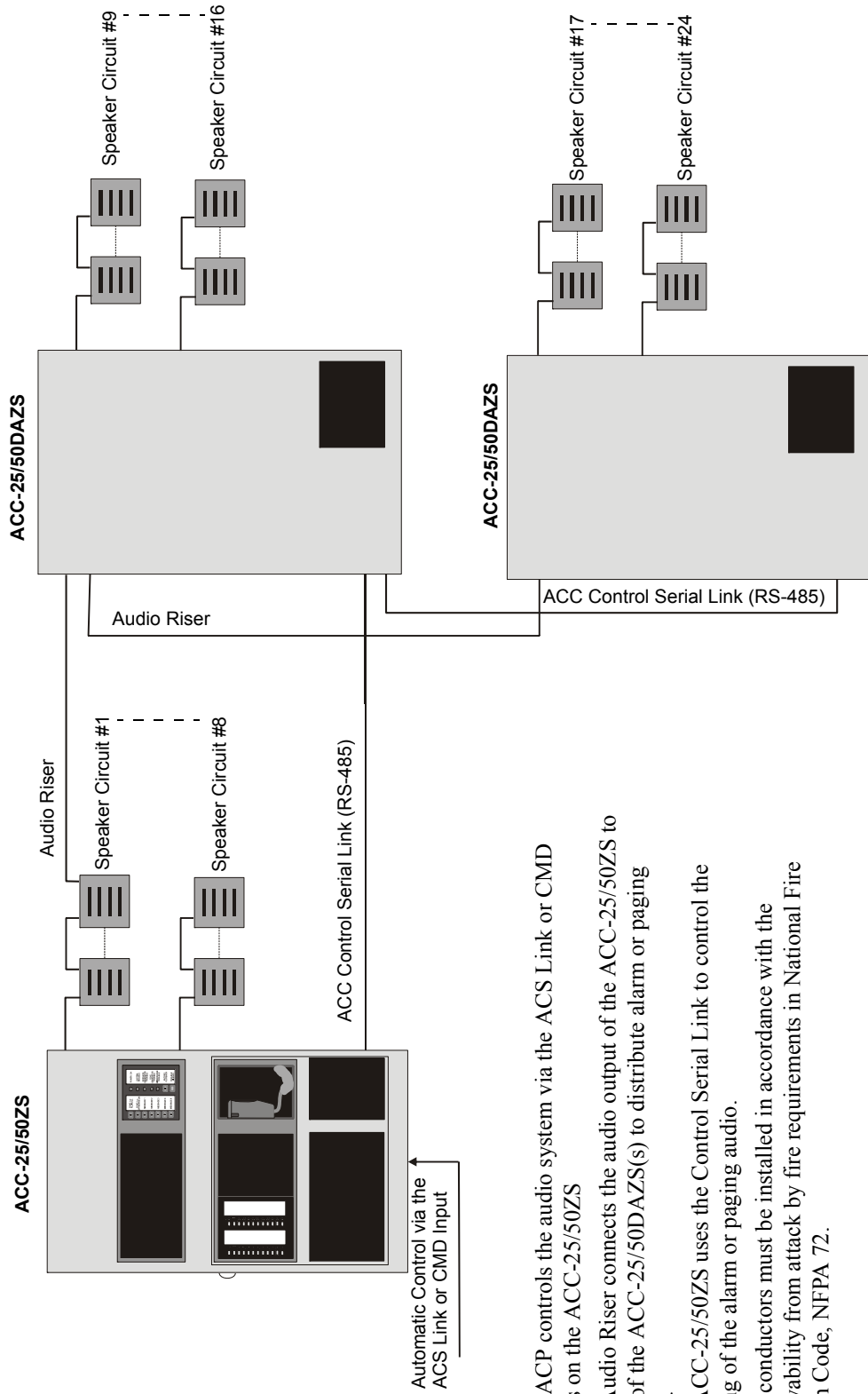

1. The FACP controls the audio system via the ACS Link or CMD inputs on the ACC-25/50ZS
2. The Audio Riser connects the audio output of the ACC-25/50ZS to each of the ACC-25/50DAZS(s) to distribute alarm or paging audio.
3. The ACC-25/50ZS uses the Control Serial Link to control the routing of the alarm or paging audio.
4. Riser conductors must be installed in accordance with the survivability from attack by fire requirements in National Fire Alarm Code, NFPA 72.

ACCDAZSDISTSYS2.wmf

Audio Command Center Zone System With FireFighter Telephone Up to 24 Zones @ 150W (max.)

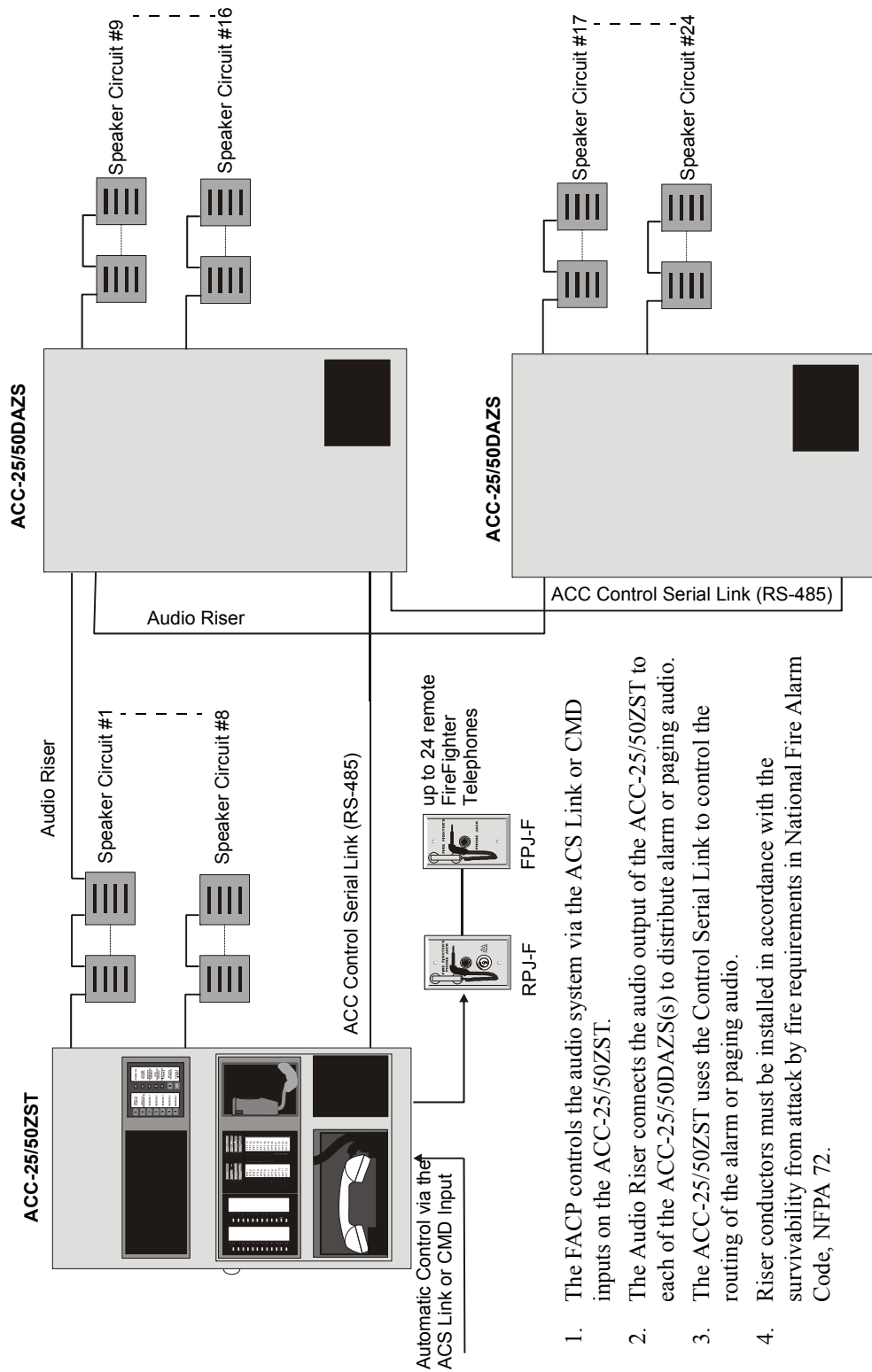

1. The FACP controls the audio system via the ACS Link or CMD inputs on the ACC-25/50ZST.
2. The Audio Riser connects the audio output of the ACC-25/50ZST to each of the ACC-25/50DAZS(s) to distribute alarm or paging audio.
3. The ACC-25/50ZST uses the Control Serial Link to control the routing of the alarm or paging audio.
4. Riser conductors must be installed in accordance with the survivability from attack by fire requirements in National Fire Alarm Code, NFPA 72.

ACCDZSDISTSYS3.wmf

Section 1: Product Description

The ACC-25/50 Series consists of the AUDIO•COMMAND•CENTER•25/50 (ACC-25/50), the AUDIO•COMMAND•CENTER•25/50 Zone System (ACC-25/50ZS), and the AUDIO•COMMAND•CENTER•25/50 Zone System with Telephone (ACC-25/50ZST) which are single channel, 25 watt, 25 VRMS, emergency voice evacuation panels. The ACC-25/50 provides up to two speaker circuits while the ACC-25/50ZS and ACC-25/50ZST support up to eight speaker circuits. Each panel provides the ability to record five field programmable messages (up to 60 seconds total message duration) with an integral microphone or from an external audio source. An integral power supply with battery charger supplies operational power. An ACC-AAM25 audio amplifier is provided standard with each base unit. An optional second ACC-AAM25 amplifier is also available for backup purposes or to provide an additional channel of 25 watts. Optional 70 VRMS conversion modules are also available for installations where 70 VRMS speakers are to be installed or already exist. An optional External Page Module (ACC-EPM) is available for interfacing to nonfire paging systems. The modular design allows for ease-of-serviceability.

Automatic activation of the ACC-25/50 by an FACP is possible via the five Command Input Circuits (CMD). The ACC-25/50ZS and ACC-25/50ZST can be automatically activated by the CMD inputs or via the ACS serial communications link from the MS-9600, MS-9200UDLS, MS-9200UD, MS-9200(E) and MS-5210UD FACP's.

Two Command Input Circuits can be independently field programmed for activation by an FACP Notification Appliance Circuit reverse polarity or by closure of a supervised normally open contact and three Command Input Circuits activate on contact closure. CMD 1 and CMD 2 provide terminals for NAC input and output to allow installation of the audio panel anywhere along the NAC circuit being used to activate it. Options via the Command Inputs allow one 60 second message, two 30 second messages, three 20 second messages, four 15 second messages or five 12 second messages.

The ACC-25/50ZS and ACC-25/50ZST include an ACC-ZPMK Zone Page Module with keypad and an ACC-ZSM Zone Splitter Module. These modules provide up to eight speaker circuits that may be manually or automatically activated.

The ACC-25/50ZST includes an ACC-FFT Fire Fighter Telephone Module with keypad which provides indications of phone activation, remote page activation, remote microphone activation and corresponding trouble conditions. Additionally, up to 24 telephone circuits can be annunciated at the ACC-FFT by connecting addressable monitor modules to the optional FPJ-F or RPJ-F Remote Page Jacks.

Significant technological enhancements set the ACC-25/50 Series apart from other voice panels. These enhancements include full supervision in both active (alarm or music) and standby conditions. Supervision is provided for:

- ✓ amplifier outputs
- ✓ field wiring (shorts and opens)
- ✓ message generator
- ✓ all tone generators
- ✓ microphone
- ✓ telephones (optional)

If the message generator fails, the system automatically reverts to the primary tone generator. If the primary tone generator fails, one of three backups become enabled.

Power is fed independently to each amplifier so that a short circuit in one amplifier will not shut down the other. Full output power of 25 watts per amplifier is generated while in a low battery condition. Power is not diminished when the optional 70 V_{RMS} transformer module is installed. Audio is amplified utilizing modern integrated circuits as opposed to transformer technology. This provides for very low signal distortion for crystal clear audio.

Primary applications for the audio panels include structures such as restaurants, schools, auditoriums, places of worship, buildings with occupancies over 50, etc. The ACC-25/50 Series is designed to interface directly to addressable or conventional fire alarm control panels or can be used with the Audio Command Center Distributed Audio (ACC-25/50DA) panel to distribute audio in systems that require more than 50 watts.

1.1 Product Features

- 25 watts of 25 V_{RMS} audio power (expandable to 50 watts) per panel
- Optional 70.7 V_{RMS} conversion module available for each amplifier (note that speaker wiring continues to be supervised in standby, alarm and when background music is playing with this option module installed)
- Modular design for maximum system flexibility
- Unobstructed module access and removable terminal blocks for ease of servicing and module replacement
- Designed to allow easy system expansion
- Five Command Input Circuits:
 - ✓ CMD1 and CMD2 are field selectable to be activated from 12 or 24 VDC Notification Appliance Circuits (reverse polarity) or contact closures
 - ✓ CMD3, CMD4, and CMD5 are activated by contact closures
- Speaker Circuits
 - ✓ single Style Y or Z speaker circuit (one ACC-AAM25 Audio Amplifier provided with base unit)
 - ✓ two Style Y or Style Z speaker circuits (with optional second ACC-AAM25 Audio Amplifier installed)
 - ✓ eight Style Y or four Style Z speaker circuits (*only on ACC-25/50ZS or ACC-25/50ZST Panel with ACC-ZSM Zone Splitter Module*)
- ACC-25/50ZS and ACC-25/50ZST can be controlled by an FACP via the ACS (EIA-485) link to the ACC-ZPMK. ACS compatible FACPs include the MS-9600, MS-9200(E), MS-9200UD, MS-9200UDLS and MS-5210UD.
- Integral supervised microphone
- Microphone time-out feature which reverts back to prerecorded message if emergency page exceeds three minutes
- Standard, prerecorded message:
 - “May I have your attention please. May I have your attention please. The signal you have just heard indicates a report of a fire in this building. Please proceed to the nearest exit and leave the building. Do not re-enter the building unless directed to do so by the proper authorities.”
- Field-selectable message and custom message field recording capability using local microphone or two compatible audio input jacks
- Two External Audio Inputs for recording custom message from compatible source or playing music over the system with prior approval of the local Authority Having Jurisdiction (AHJ)
- Multiple duration message capability: one 60 second, two 30 second, three 20 second, four 15 second or five 12 second custom messages
- Integral tone generators field selectable for steady, slow-whoop, high-low or chime tones
- Higher wattage capability available by using the Audio Command Center Distributed Audio (ACC-25/50DA) panel
- Powered by integral AC power supply or batteries during AC fail
- Programmable delay of immediate, 2 hours or 6 hours reporting of AC Loss
- Piezo sounder for local trouble

- Two Form-C trouble relays:
 - ✓ System Trouble Relay - TB1
 - ✓ AC Power Loss Relay - TB7
- 35 mA Special Application (auxiliary power) output for addressable modules when interfaced with the Fire•Lite MS-9200(E) or MS-9600 FACP or equivalent and End-of-Line power supervision relays
- Integral Dress Panel
- Optional ACC-TR semi-flush trim ring
- ACC-FFT Fire Fighter Telephone module for control and annunciation of up to 24 remote telephone jacks (*installation in ACC-25/50ZST only*)
- Fire Fighter Handset (FHS-F) used to communicate over the telephone circuit connected to the ACC-FFT (*ACC-25/50ZST only*)
- Fire Fighter Phone Jack FPJ-F provides plug-in location for the FHS-F (*ACC-25/50ZST only*)
- Remote Page Jack RPJ-F provides plug-in location for the FHS-F and All-Call paging capability (*ACC-25/50ZST only*)
- Fire Fighter Handset Cabinet FHSC-RF (recess mount) or FHSC-SF (surface mount) is used to store five Fire Fighter Handsets (FHS-F) (*ACC-25/50ZST only*)
- Optional FC-RM Remote Microphone (includes cabinet and FC-MIM Microphone Interface Module). Refer to the FC-RM Product Installation Document #51247 for additional information
- Optional ACC-EPM External Page Module for interfacing to non-fire paging systems
- Optional local playback speaker (FC-LPS)
- System Status LEDs (refer to “Controls and Indicators” on page 23)
- Master Command Bus output for All-Call paging control of Distributed Audio panels in non-zone split systems

All CMD inputs are supervised, power-limited. When contact closure is employed, a 4.7KΩ ELR, P/N: 27072 is required.

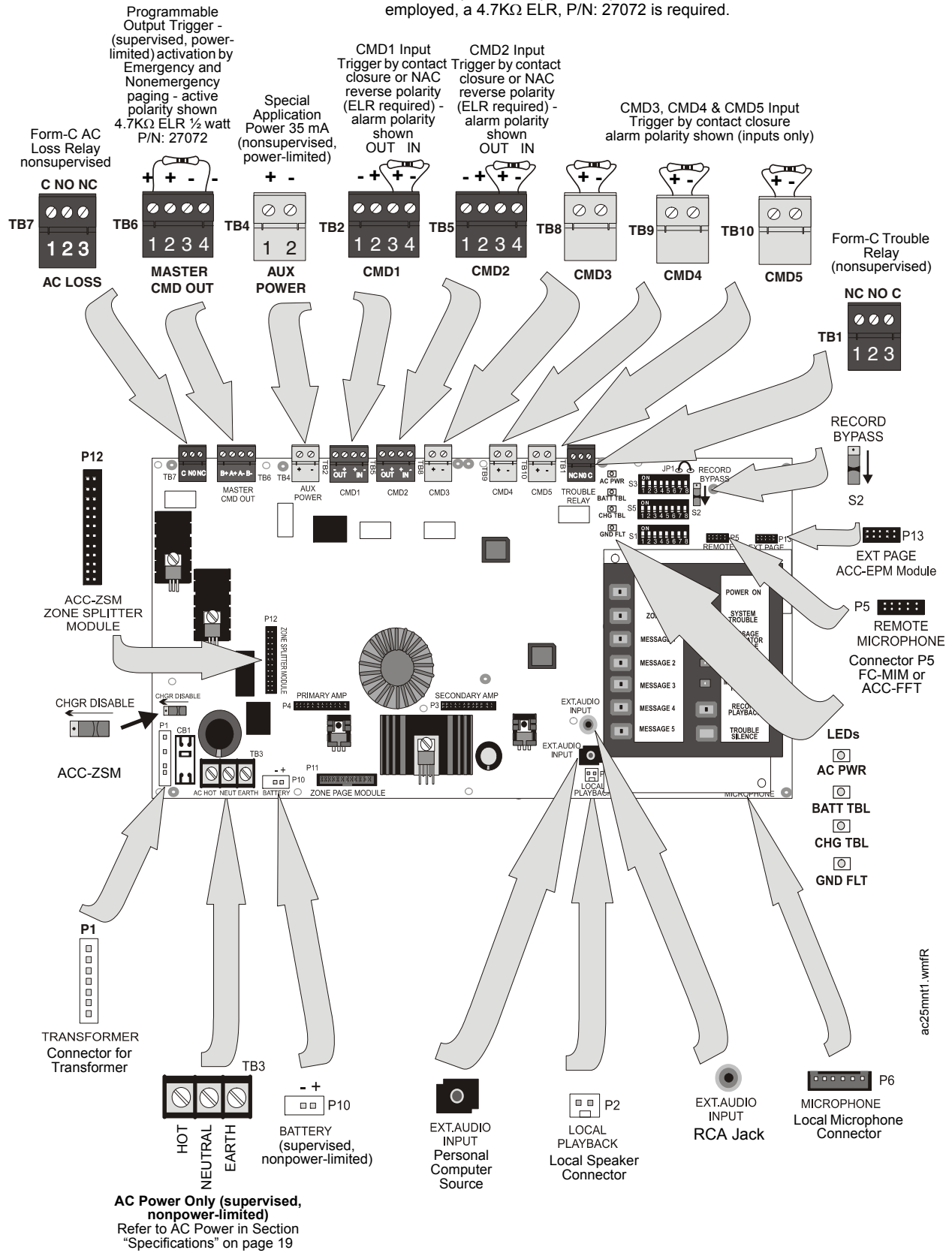

Figure 1.1 Audio Command Center Board



CAUTION: OBSERVE PROPER POLARITY
 MATCH PROPER POLARITY CONNECTIONS TO FIELD WIRING AND SPEAKERS. POLARITY SHOWN IS IN THE STANDBY AND ALARM CONDITIONS.

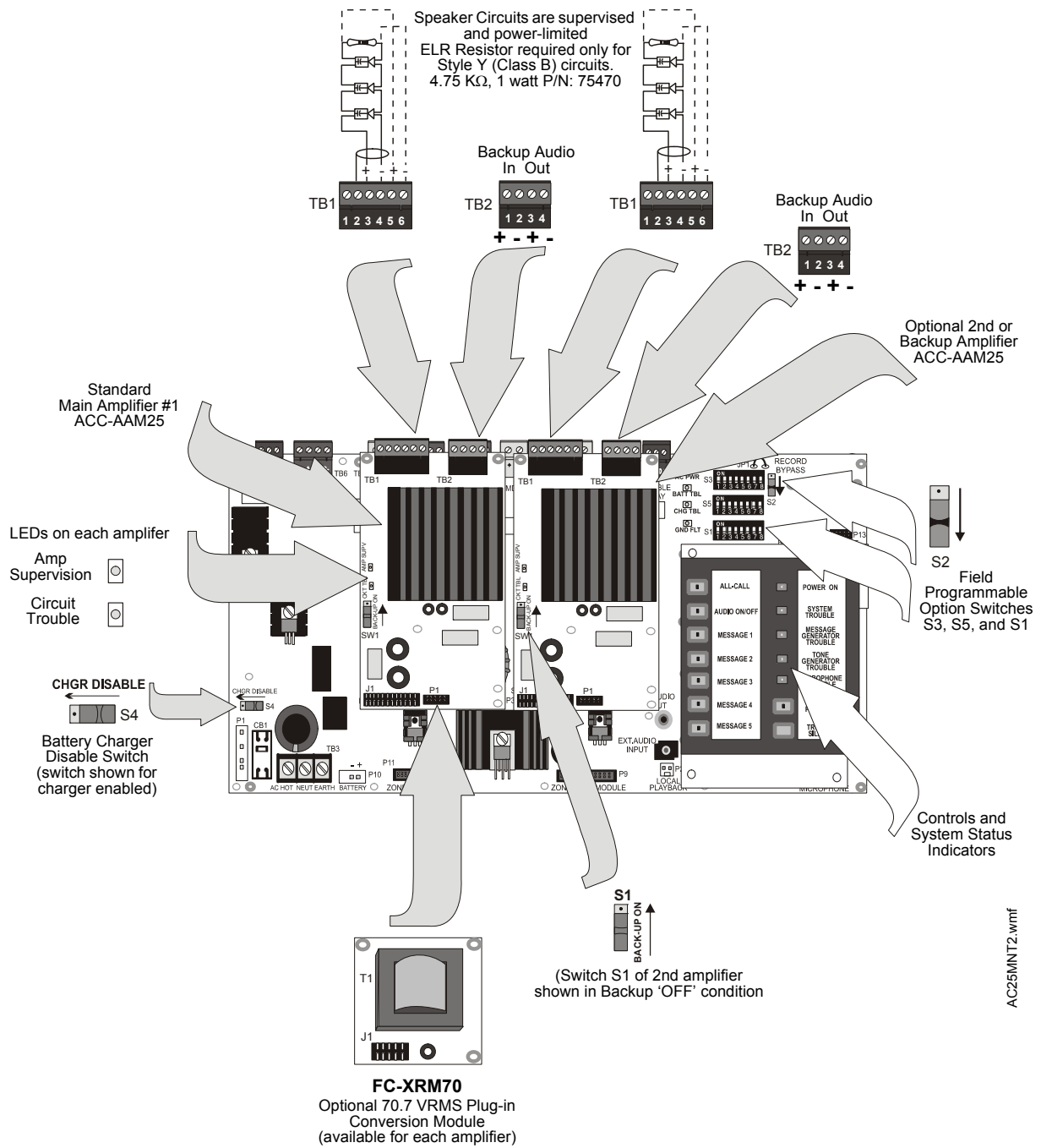

Figure 1.2 Command Board With Amplifiers

ACC-25/50ZS Modules

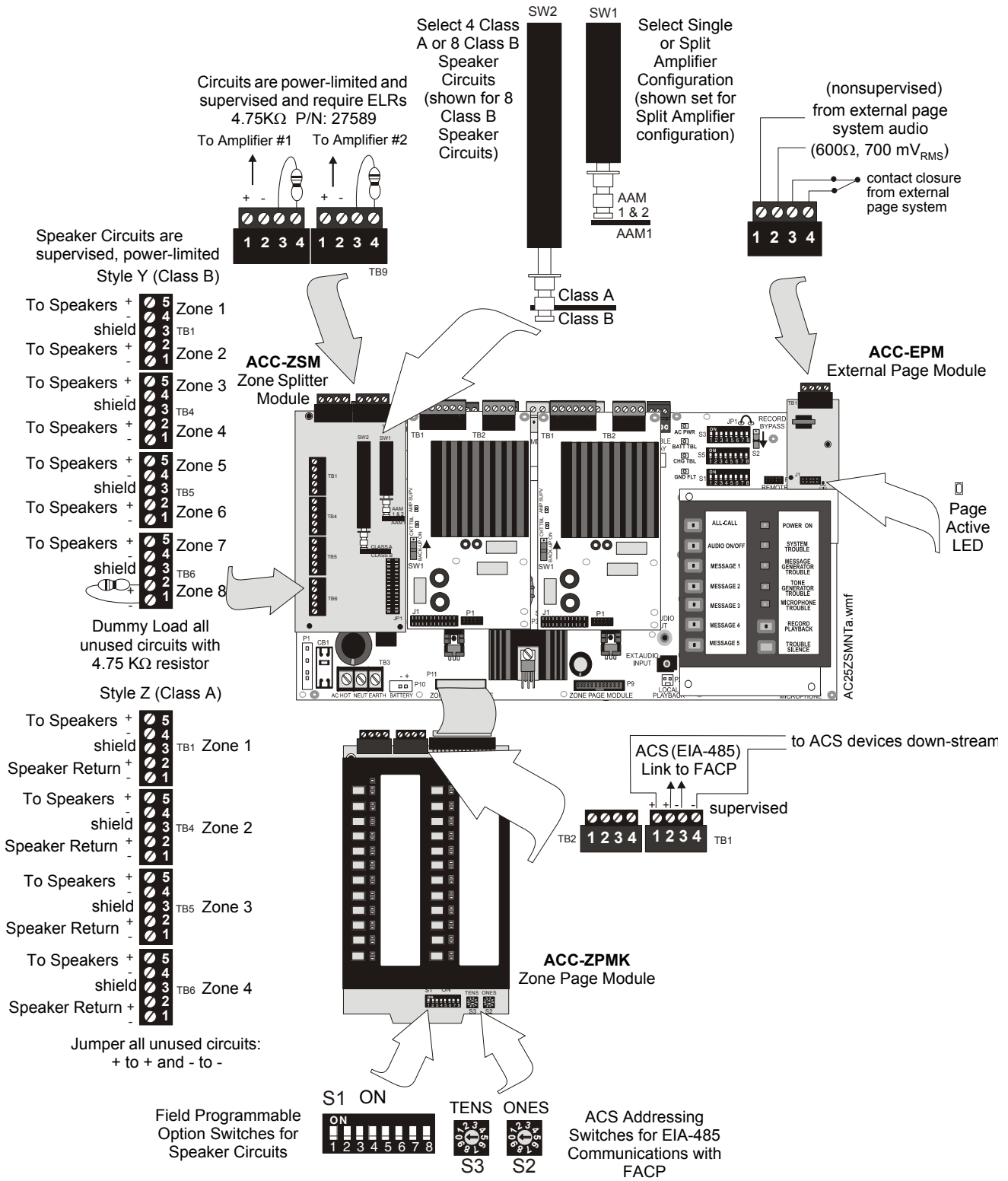
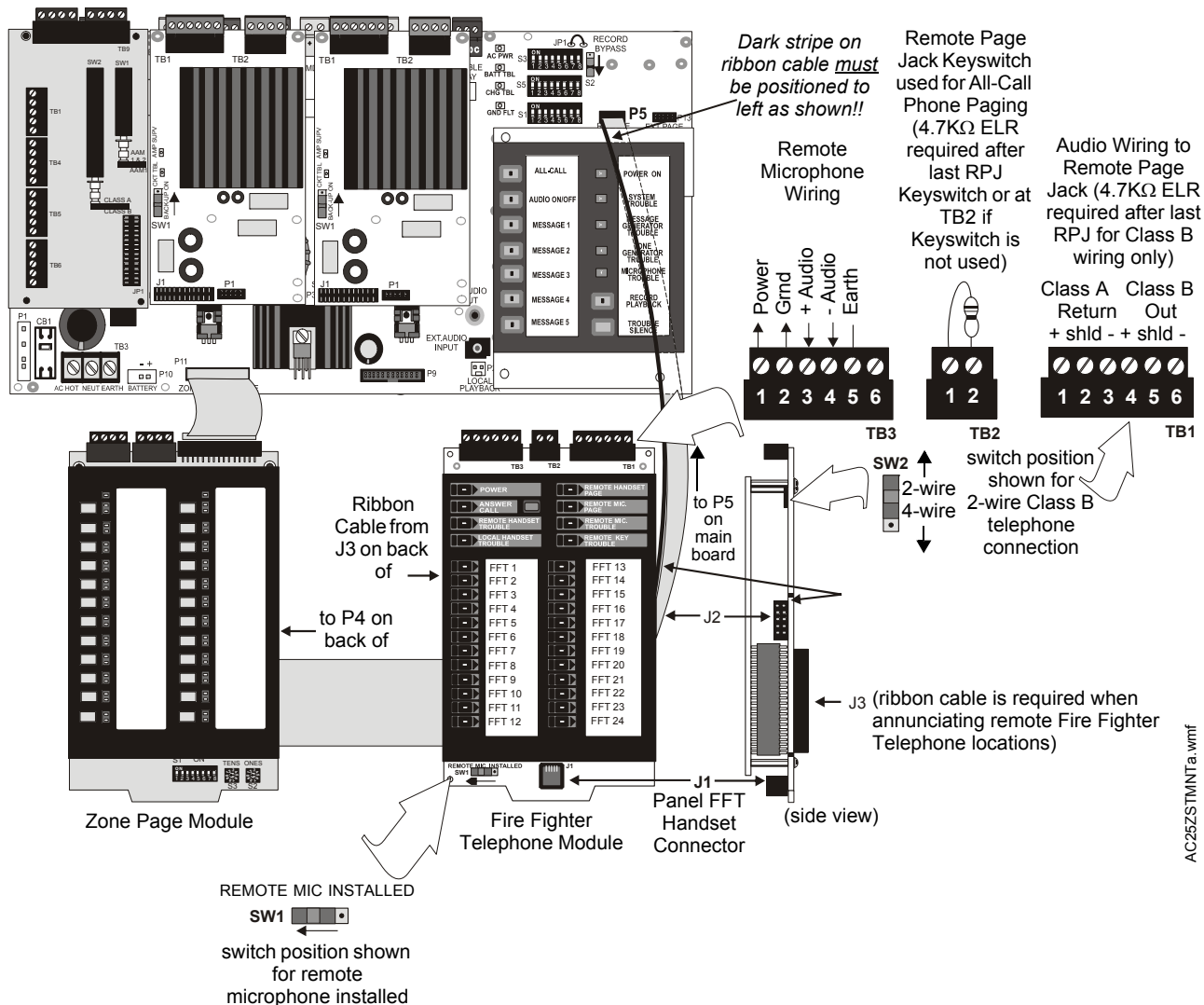

Figure 1.3 ACC-25/50ZS Main Board With Modules

ACC-25/50ZST with ACC-FFT Module



AC25ZSTMNTa.wmf

Figure 1.4 ACC-25/50ZST Main Board with ACC-FFT Module

1.2 Specifications

AC Power - TB3

ACC-25/50, ACC-25/50ZS, ACC-25/50ZST: 120 VAC, 60 Hz, 1.5 amp.
Wire size: minimum #14 AWGb with 600 V insulation.

AC Loss Relay - TB7

Operation: normally energized fail-safe relay transfers on AC power loss for independent monitoring by DACT. AC Loss Relay can be programmed to be the only indication of an AC loss condition (see Table 2.3 on page 34).

AC Loss relay contact rating: 2.0 amps @ 30 VDC (resistive), 0.6 amps @ 30 VAC (resistive)

Battery (lead acid only) - P10

Maximum Charging Circuit: Normal Flat Charge - 27.6V @ 0.800 amp

Maximum Charger Capacity: 18 Amp Hour battery. (Audio Command Center Series cabinet holds max. 18 Amp Hour Battery.

Command Input Circuits (alarm polarities shown)

- CMD1 - TB2 Terminals 3(+) & 4(-) are input terminals and Terminals 1(-) and 2(+) are output terminals which provide feed through of the NAC circuits to NAC devices down stream
- CMD2 - TB5 Terminals 3(+) & 4(-) are input terminals and Terminals 1(-) and 2(+) are output terminals which provide feed through of the NAC circuits to NAC devices down stream
- CMD3 - TB8 Terminals 1(+) & 2(-) are input terminals for contact closure only
- CMD4 - TB9 Terminals 1(+) & 2(-) are input terminals for contact closure only
- CMD5 - TB10 Terminals 1(+) & 2(-) are input terminals for contact closure only

Operation: CMD1 & CMD2 circuits are independently field programmable to activate amplifiers on NAC polarity reversal or contact-closure. **IMPORTANT!** When CMD1 and CMD2 are configured for reverse polarity, the NAC cannot be Coded.

CMD3, CMD4 and CMD5 are fixed to activate on contact closure only. End-of-Line resistors must be connected in all configurations.

Power-limited and supervised circuitry

Normal Operating Voltage Range: 10.5 VDC - 29 VDC; Maximum Voltage: 29 VDC

NAC Reverse Polarity Current (requires End-of-Line Resistor from NAC): 1.6 mA maximum.

Contact Closure Operation Current (requires 4.7K, ½ watt End-of-Line Resistor P/N 27072): 6.6 mA maximum

Maximum Wiring Impedance CMD1 - CMD5 (Contact Closure Operation): 200Ω

Maximum Input Impedance:

- CMD1 & CMD2 (Reverse Polarity Operation): 20KΩ
- CMD1 - CMD5 (Contact Closure Operation): 3.4KΩ

Audio Amplifier Module

Standard ACC-AAM25 Amplifier plugs into P4 of main circuit board, optional ACC-AAM25 Amplifier plugs into P3 of main circuit board

Backup Audio - TB2 [In Terminals 1(+) & 2(-), Out Terminals 3(+) & 4(-)] on Amplifier Module

Operation: When TB2 is wired between the two amplifiers of a panel, the optional amplifier provides backup to the standard amplifier. Switch S1 on the backup amplifier must be 'ON' and jumpers placed from backup amplifier TB2 Terminal 3 to standard amplifier TB2 Terminal 1 and from backup amplifier TB2 Terminal 4 to standard amplifier TB2 Terminal 2. Refer to Section "One Speaker Circuit With Backup on ACC-25/50" on page 81, for additional information.

Speaker Circuit - TB1 Terminals 3(+) & 4(-) Style Y, 5(+) & 6(-) Style Z, 1 & 2 Shield (Standby and Alarm Polarity Shown) on Amplifier Module

Power-limited circuitry

Operation: Circuit can be wired Style Y or Style Z

Normal Operating Voltage: 25 V_{RMS} @ 1 amp max. and maximum Load Impedance of 25Ω

(70.7 V_{RMS} @ 350 mA max. with maximum Load Impedance of 200Ω operation possible by plugging optional FC-XRM70 conversion module into P1 of audio amplifier).

Circuit wiring is supervised during standby, alarm and when background music is playing

Output Power: 25 watts (20 watts when background music is employed);

Frequency Range: 800Hz - 2,800Hz

Maximum total capacitance for each speaker circuit: 250 μF.

End-of-Line Resistor required for Style Y circuit: 4.75 KΩ, 1 watt (P/N: 75470)

ACC-ZSM Zone Splitter Module and ACC-ZPMK Zone Page Module (ACC-25/50ZS/T Only)

Power-limited circuitry

Operation: Circuits on ACC-ZSM can be wired as eight Style Y or four Style Z

Normal Operating Voltage for Speaker Circuits: 25 V_{RMS} @ 1 amp max. and maximum Load Impedance of 25Ω

(70.0 V_{RMS} @ 350 mA max. with maximum Load Impedance of 200Ω operation possible by plugging optional FC-XRM70 conversion module into P1 of audio amplifier).

Speaker circuit wiring is supervised during standby and alarm. (*Note that background music is not permitted in Zone Splitter configuration since open-circuit fault detection is not possible*)

Output Power: 25 watts total; Frequency Range: 800Hz - 2,800Hz

Maximum total capacitance for ACC-AAM25: 250 μF. (*Note that the total capacitance for the ACC-ZSM speaker outputs must not exceed the maximum of 250 μF.*)

End-of-Line Resistor required for Style Y (Class B) speaker circuit: 4.75 KΩ, 1 watt (P/N: 75470)

TB1 on ACC-ZPMK: ACS (EIA-485) electrically isolated link to FACP provides programmed speaker control

ACC-FFT Fire Fighter Telephone Module (ACC-25/50ZST Only)

Power-limited circuitry

TB1 Remote Phone Circuit Operation: Circuit can be wired Style Y (Class B) or Style Z (Class A)

Wiring connects Remote Page Jacks (FPJ-F or RPJ-F) to control panel for phone communication

Normal Operating Voltage (V_{RMS}): Standby = n/a, Active = 0.2 V_{RMS}

Normal Operating Voltage (VDC): Standby = 12 VDC, Active = 4 VDC to 0.9 VDC

Normal Operating Current (mA): Standby = 1.3 mA, Active = 5 mA

Circuit wiring is supervised.

Maximum wiring impedance = 54Ω

End-of-Line Resistor required for Style Y circuit: 4.7KΩ, ½ watt

TB2 Remote Page Jack Keyswitch Operation: Circuit wired Class B

Keyswitch enables All-Call Paging by FHS-F Remote Phone

Requires RPJ-F

Circuit wiring is supervised.

Maximum wiring impedance = 54Ω

End-of-Line Resistor required: 4.7KΩ, ½ watt

TB3 Remote Microphone Operation:

Provide connection for the optional FC-RM Remote Microphone Module which is used for remote paging capabilities.



NOTE: For installations that require both the Fire Fighter Telephone and Remote Microphone, the Remote Microphone Module wiring connections are made to the ACC-FFT Fire Fighter Telephone Module.

Master CMD Out - TB6 Terminals 1(+), 2(+), 3(-) & 4(-) (active polarity shown)

Provides All-Call Paging trigger for Distributed Audio units (ACC-25/50 ONLY). Will drive MR-101C or MR-201C relays (manufactured by Air Products and Controls) to provide relay contacts.

Supervised and power-limited circuitry

Programmed Operation: Output reverses polarity on activation of All-Call switch, Remote Microphone or External Page Module input.

Normal Operating Voltage: 24 VDC regulated, filtered; Maximum Voltage: 25.4 VDC

Reverse Polarity Current: 125 mA maximum.

Standby Voltage: -5 VDC. Short Circuit Current: 0.5 mA. Maximum Load Resistance: 200 ohms.

Wiring connections to Master CMD Output Circuit:

- ✓ End-of-Line Resistor required for Class B using Terminals 1(+) & 4(-): 4.7 K Ω ½ watt (P/N: 27072)
- ✓ Class A (no End-of-Line Resistor) requires the wiring of Terminal 1(+) to 2(+) and Terminal 3(-) to 4(-)

Up to 25 Distributed Audio Panels may be connected to this output (ACC-25/50 Only)

Special Application Power (Aux. Power) - TB4 Terminals 1(+) & 2(-)

Up to 35 mA @ 24 VDC of special application power is available for powering addressable modules and associated End-of-Line power supervision relays.

Power-limited circuitry. Refer to the Device Compatibility Document for a list of compatible devices.

Form-C Trouble Relay - TB1

Normally energized fail-safe relay can be programmed to transfer its contacts on any panel trouble condition or on any trouble condition *except* AC Loss (see Table 2.3 on page 34).

TB1 Form-C relay contact rating: 2.0 amps @ 30 VDC (resistive), 0.6 amps @ 30 VAC (resistive).

External Audio Input

- RCA Audio Jack Input (female connector)
 - Input Impedance: 30K Ω maximum
 - Input Voltage: 700 mV_{RMS} maximum
 - Input Current: 1 mA maximum @ 700 mV
 - Requires preamplifier output. Mates to an RCA phono 'plug' - 3mm diameter, 10mm length, 9mm shell diameter.
- 3.5 mm PC Audio Jack Input (female connector)
 - Requires preamplifier output
 - Interfaces to personal computer line output



NOTE: Some laptop personal computers only provide an audio output for headphones. It may be necessary to adjust the headphone output level for proper recording of voice messages.

FC-MIM Microphone Interface Module (Optional) - P5 Connector

Connector P5 provides a connection for:

- the optional FC-MIM Microphone Interface Module which is used to connect the FC-RM Remote Microphone Module to provide remote microphone paging capabilities.
- the ACC-FFT Fire Fighter Telephone module which is used for emergency telephone applications.



NOTE: For systems that require both the Remote Microphone and Fire Fighter Telephone, the ACC-FFT is connected to the P5 connector on the main circuit board and the Remote Microphone connections are made on the ACC-FFT. The FC-MIM is incorporated into the ACC-FFT Fire Fighter Telephone Module as part of the ACC-25/50ZST. A separate FC-MIM is therefore not required for this system.

Microphone connector for Fire•Lite standard microphone P/N:45025 - P6 Connector ACC-EPM External Page Module (Optional)

Audio Input Impedance: 600 Ω maximum

Audio Input Voltage: 700 mV_{RMS} maximum

Audio Input Current: 1 mA maximum @ 700 mV

Contact Closure Operation Current: 2.3 mA maximum

External paging equipment is electrically isolated from ACC-25/50, ACC-25/50ZS and ACC-25/50ZST

1.3 Controls and Indicators

1.3.1 Single Zone Operation (ACC-25/50, ACC-25/50ZS, ACC-25/50ZST)

Figure 1.5 depicts Single Zone operation with the maximum capacity of five messages. Single Zone may be configured for two to five message control (refer to Section 2, "Field Programming" on page 32).

- **ALL-CALL:**
 - ✓ used to select All Call function when ACC-25/50 Series is programmed for Single Zone operation. Selecting this button also activates the Master Command Bus, which is used to trigger Distributed Audio Panels. *Single Zone operation directs the same message to both amplifier circuits (S3 DIP switches 1, 2 and 3 set to one of the valid options other than all OFF)*
- **AUDIO ON/OFF:**
 - ✓ used to indicate that speaker circuits are activated when ACC-25/50 Series is programmed for Single Zone operation (*S3 DIP switches 1, 2 and 3 set to one of the valid options other than all OFF*). Push-button switch can be used to deactivate the audio amplifiers that were activated by the FACP
- **MESSAGE 1 -** used to manually transmit Message 1 over speaker circuit
- **MESSAGE 2 -** used to manually transmit Message 2 over speaker circuit
- **MESSAGE 3 -** used to manually transmit Message 3 over speaker circuit
- **MESSAGE 4 -** used to manually transmit Message 4 over speaker circuit
- **MESSAGE 5 -** used to manually transmit Message 5 over speaker circuit

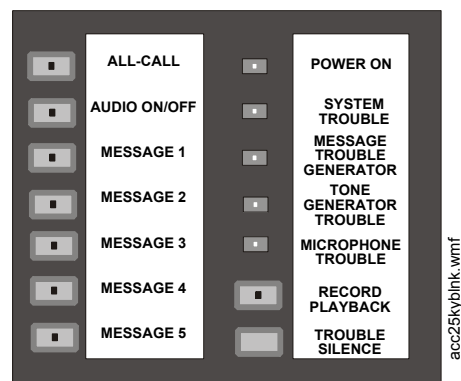

Figure 1.5 Controls and Indicators Single Zone Operation

1.3.2 Dual Zone Operation (ACC-25/50 Only)

Figure 1.6 depicts Dual Zone operation which supports the generation of one message only (refer to Section 2, "Field Programming" on page 32).

- **ZONE 1:**
 - ✓ used to select Zone 1 when ACC-25/50 is programmed for Dual Zone operation. *Dual Zone operation directs a single message to either or both amplifier circuits (S3 DIP switches 1, 2 and 3 set to OFF).*
- **ZONE 2:**
 - ✓ used to select Zone 2 when ACC-25/50 is programmed for Dual Zone operation (*S3 DIP switches 1, 2 and 3 set to OFF*)

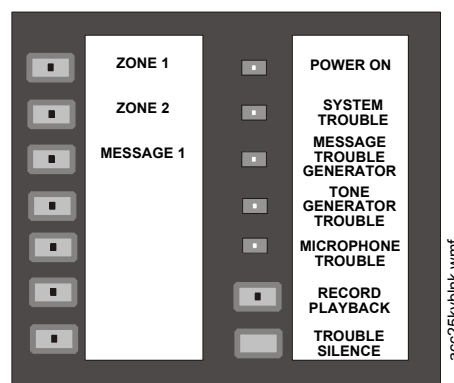

Figure 1.6 Controls and Indicators Dual Zone Operation

1.3.3 RECORD/PLAYBACK

- ✓ for recording messages when Record/Bypass switch is in the up Record position (refer to Section “S2 - Record Bypass Switch on ACC-25/50 Series Motherboard (ACC-MCB)” on page 38, Section 2.1, “S1 DIP Switch Settings on ACC-25/50 Series Motherboard (ACC-MCB)” on page 36 and Section 2.2, “S5 DIP Switch Settings on ACC-25/50 Series Motherboard (ACC-MCB)” on page 37 for additional information on recording messages.)
- ✓ for reviewing recorded message when Record Bypass Switch is in the down Bypass position (requires optional FC-LPS module).

1.3.4 TROUBLE SILENCE

- ✓ momentary depression silences the local piezo when system is in trouble condition.

1.3.5 LEDs (visible with panel door closed):

- Power ON (green)
- System Trouble (yellow)
- Message Generator Trouble (yellow)
- Tone Generator Trouble (yellow)
- Microphone Trouble (yellow)
- Record/Playback (green)
- Dual Zone
 - ✓ Zone 1 (green = active, yellow = manual deactivation)
 - ✓ Zone 2 (green = active, yellow = manual deactivation)
- Message 1 (green = activation)
- Message 2 (green = activation)
- Message 3 (green = activation)
- Message 4 (green = activation)
- Message 5 (green = activation)
- Single Zone
 - ✓ All Call (green = active)
 - ✓ Audio On/Off (green = active, yellow = manual deactivation)

1.3.6 ACC-ZPMK Zone Page Module (ACC-25/50ZS and ACC-25/50ZST Panels only)

Push button Switches

24 tactile push-button switches used to manually activate the corresponding speaker zone. If speaker zone has been activated by the FACP programming, pressing the switch will deactivate the speaker zone and illuminate the corresponding yellow zone LED and the System Trouble LED.

LEDs

- FACP Communication (green = active, extinguished = no communication)
The (top left LED) communication should only be active if the ACC-25/50ZS/T is connected to an FACP and communication via the ACS link is established.

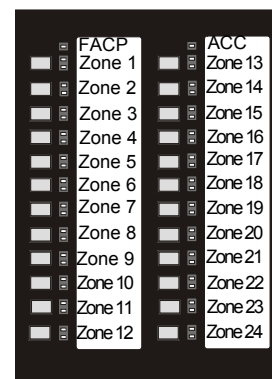

- ACC Communication (green = active, extinguished = no communication)
This (top right LED) indicates communication between the ACC-ZPMK and the ACC-25/50ZS/T main circuit board via the connecting ribbon cable.
- Speaker Circuit Zones 1 through 24 (green = active, yellow = trouble/disabled)
Only the LEDs for Zones 1 through 8 will be functional if the ACC-ZSM is configured for Style Y (Class B) operation or only the LEDs for Zones 1 through 4 will be functional if the ACC-ZSM is configured for Style Z (Class A) and no ACC-25/25DAZS Distributed Audio panels are connected.

1.3.7 ACC-FFT Fire Fighter Telephone Module (ACC-25/50ZST only)

Pushbutton Switches

- Answer Call - tactile pushbutton switch used to connect or disconnect Remote Telephone FHS-F plugged into the FPJ-F or RPJ-F from the ACC-FFT.

LEDs

- Power (green) - indicates that power is applied to the ACC-FFT Fire Fighter Telephone module
- Answer Call (green LED) - flashes to indicate that a remote phone (FHS-F) has been plugged into the FPJ-F or RPJ-F on the telephone circuit. LED turns on steady when Answer/Call pushbutton is pressed to answer the remote phone call
- Remote Handset Page (green LED) - turns on steady to indicate that a remote phone (FHS-F) has been connected to the telephone circuit and the Remote Page Jack Keyswitch on the RPJ-F has been activated for remote paging
- Remote Microphone Page (green LED) - turns on steady to indicate active paging from Remote Microphone
- Remote Handset Trouble (yellow LED) - turns on steady to indicate that a fault exists on the telephone circuit connected to TB1 of the ACC-FFT
- Local Handset Trouble (yellow LED) - turns on steady to indicate that the local handset has a connection fault
- Remote Key Trouble (yellow LED) - turns on steady to indicate a remote keyswitch wiring fault (TB2)
- Remote Microphone Trouble (yellow LED) - turns on steady to indicate a fault on the Remote Microphone wiring or electronics (TB3)
- FFT 1 through FFT 24 (green LEDs) - LED for each of 24 possible remote phone circuits will turn on if an addressable monitor module has been connected and programmed for activation when a remote phone (FHS-F) is plugged into the corresponding Remote Page Jack (FPJ-F or RPJ-F)

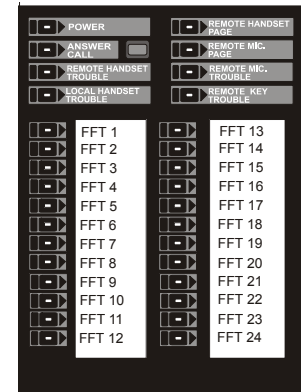

1.3.8 ACC-EPM External Page Module

- Page Active (green=active)

1.3.9 Other System LEDs (located on main circuit board and modules)

- AC Power (green) - main circuit board
- Battery Trouble (yellow) - main circuit board
- Charger Trouble (yellow) - main circuit board
- Ground Fault (yellow) - main circuit board
- Circuit Trouble (yellow) - Amplifier module

- Amplifier Supervision (green) - Amplifier module

1.4 Circuits

Input Circuits - CMD1, CMD2, CMD3, CMD4 & CMD5

- Input circuits CMD1 and CMD2 are independently field programmable to accept Notification Appliance Circuits or normally open contacts. (**IMPORTANT!** *When CMD1 and CMD2 are configured for reverse polarity, the NAC cannot be Coded*). Terminals are provided to allow feed-through of the NACs, allowing placement of the ACC-25/50 Series anywhere along a Notification Appliance Circuit. A trouble on the ACC-25/50 Series will cause relay contacts at the out terminals of CMD1 to open, causing an NAC circuit trouble at the FACP.



NOTE: The ACC-25/50 Series will not open the out terminals while in alarm or during AC loss if the Trouble Relay is programmed not to transfer on AC Loss conditions (refer to Switch 8 in Table 2.3 on page 34). Monitoring ACC-25/50 Series troubles while in alarm requires use of independent trouble relay at TB1.

- Programming CMD1 and/or CMD2 for activation on contact closure will allow activation of the amplifiers on a normally open contact transfer to the closed condition. Contact wiring is supervised for open conditions. A short will cause amplifier activation (contact closure).
- Input circuits CMD3, CMD4 and CMD5 will only activate on contact closure which will allow activation of the amplifiers on a normally open contact transfer to the closed condition. Contact wiring is supervised for open conditions.

Audio Input Jacks

- RCA Jack provides convenient connection to an audio source such as a tape player for recording a new digital message. It may also be used for background music if approved by local AHJ. Background music is prohibited during AC loss conditions to preserve battery power.
- PC Jack provides convenient connection to an audio source such as a personal computer for recording a new digital message. The jack allows vertical plug-in of a standard mini-jack cable. It may also be used for background music if approved by local AHJ. Background music is prohibited during AC loss conditions to preserve battery power.

Output Circuits

- Specific Application Power Output, 35 mA @ 24 VDC.
- Main circuit provides a 24 Volt Battery Charger (up to 18 AH batteries) @ 800 mA maximum.

Master Command Output Bus

- Normal Operating Voltage: 24 VDC regulated, filtered. Reverse Polarity Current 120 mA maximum
- Output reverses polarity on activation
- All-Call Paging control bus for the Audio Command Center Distributed Audio panel (ACC-25/50DA) or other Fire•Lite UL-listed audio products

Notification Appliance Circuit

- One NAC Speaker Circuit Style Y or Style Z with each ACC-AAM25 amplifier module.
- Four NAC Speaker Circuits Style Z or eight Style Y with ACC-ZSM (*ACC-25/50ZS/T only*)

Relays

- One Form-C Trouble Relay. Contacts are rated 2.0 amps @ 30 VDC (resistive) and 0.6 amps @ 30 VAC (resistive)

- One Form-C AC Loss Relay. Contacts are rated 2.0 amps @ 30 VDC (resistive) and 0.6 amps 30 VAC (resistive).



NOTE: The Trouble Relay can be programmed to transfer on any trouble condition *including* AC Loss or on any trouble condition *except* AC Loss (see Switch 8 in Table 2.3 on page 34).

FC-MIM Microphone Interface Module or ACC-FFT Fire Fighter Telephone Module

- Connector P5 provides a connection for the optional FC-MIM Microphone Interface Module which is used to connect the FC-RM Remote Microphone to provide remote microphone paging capabilities for the ACC-25/50 and ACC-25/50ZS (refer to Remote Microphone Installation document #51247).
- Connector P5 provides a cable connection to the optional ACC-FFT Fire Fighter Telephone Module connector J2 for the ACC-25/50ZST Zone System with Telephone. The FC-MIM module function is incorporated into the ACC-FFT module eliminating the need for the FC-MIM (refer to Section “ACC-FFT Fire Fighter Telephone Module (ACC-25/50ZST Only)” on page 55.

ACC-EPM External Page Module

- Connector P13 provides a connection for the optional ACC-EPM External Page Module which is used to connect external non-emergency page equipment. The electrically isolated signal from the external equipment is not supervised by the ACC-25/50 Series panels. Alarm condition and paging from the ACC-25/50 Series panels have priority and will override all external page functions. To preserve battery power, non-emergency paging is prohibited during AC loss conditions.

ACC-ZPMK Zone Page Module (ACC-25/50ZS & ACC-25/50ZST only)

- Connector P11 provides a connection for the ACC-ZPMK Zone Page Module which is used to annunciate and control the selection of speaker circuits. Refer to Section “ACC-ZPMK Zone Page Module - ACS Link (ACC-25/50ZS & ACC-25/50ZST)” on page 52.

Local Speaker

- Connector P2 provides a connection for an optional, removable local speaker P/N: FC-LPS, to be used for reviewing the digital message without broadcasting over the system speakers. Figure 3.19, “Installation of Speaker Module” on page 60. This option module must be installed to take advantage of the Playback feature. Note that The FC-LPS must be removed after use.

1.5 Components

Main Circuit Board

The ACC-25/50 Series main circuit board contains the system's CPU, tone generators, special application auxiliary 35 mA power output, DIP switches for field programmable features, digital message recorder/generator, integral microphone input and pre-amplifier, other primary components and wiring interface components. One amplifier module is supplied mounted to the main circuit board. The ACC-25/50ZS and ACC-25/50ZST also include one ACC-ZPMK Zone Page Module and one AC-ZSM Zone Splitter Module (refer to Figure 1.3 on page 18). The ACC-25/50ZST also includes one

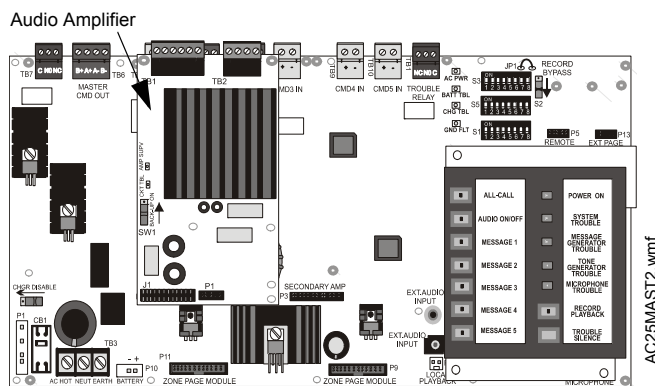

Figure 1.7 Main Circuit Board

ACC-FFT Fire Fighter Telephone Module (refer to Figure 1.4 on page 19). Optional modules can be plugged in and mounted to the main circuit board. The main circuit board is delivered pre-mounted in the cabinet.

Audio Amplifier Module [ACC-AAM25]

A single Audio Amplifier Module is installed in the ACC-25/50 Series. The amplifier provides 25 watts of power at 25 V_{RMS} . An optional module, P/N: FC-XRM70, converts the 25 V_{RMS} output to 70.7 V_{RMS} . One fully supervised and power-limited speaker circuit is provided on the amplifier module. The circuit can be wired for Style Y (Class B) or Style Z (Class A) operation.

LEDs are provided to indicate Amplifier Supervision (green indicates amplifier is functional) and Circuit Trouble (yellow indicates field wiring fault or amplifier fault). The LEDs are only visible with the panel door open.

Cabinet

The cabinet is red with an attractive navy blue front overlay. A clear window allows viewing of status LEDs and location of microphone. The backbox measures 26.0" x 15.5" x 4.75" and provides space for two batteries (up to 18 Amp Hours). The ACC-25/50ZS and ACC-25/50ZST cabinets provide a clear window to view the ACC-ZPMK module which is mounted in the center left portion of the cabinet and the ACC-FFT module which is mounted in the center right portion of the cabinet.

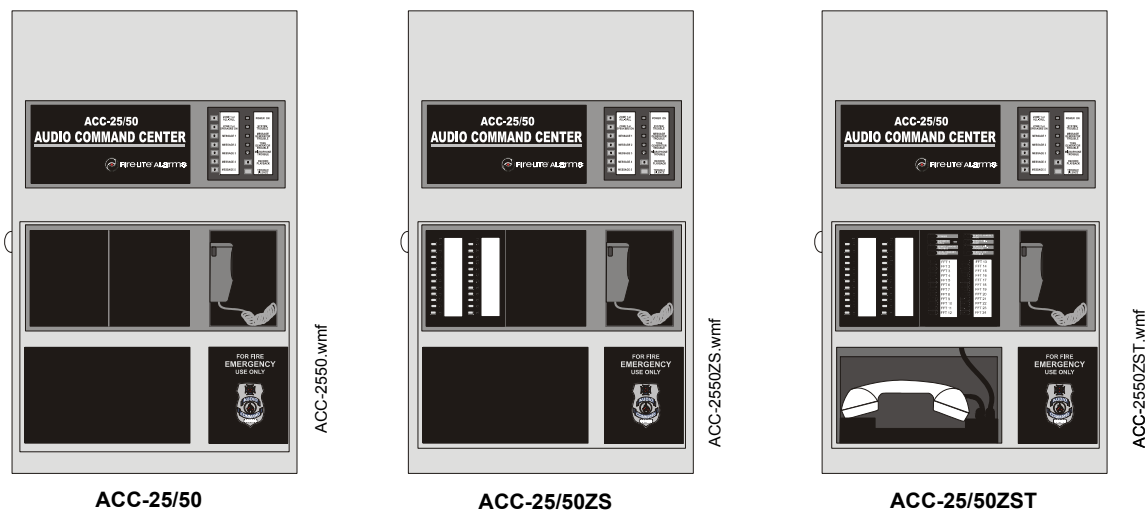

Figure 1.8 Cabinets

Batteries

The cabinet provides space for 18 Amp Hour batteries (charged by integral Power Supply/Battery Charger module).

Dress Panel

The Dress Panel is supplied standard with the system. It mounts to the cabinet with two supplied screws. The Dress Panel protects the user from high voltages and circuit boards from accidental damage. All system LEDs are visible with the Dress Panel installed.

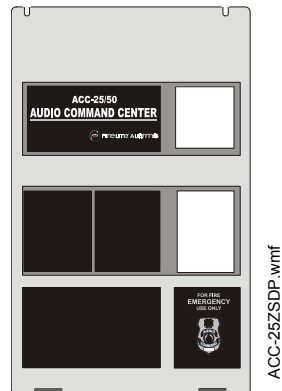

Figure 1.9 Dress Panel

Trim Ring

An optional ACC-TR trim ring is available for semi-flush mounting of the audio panel.

1.6 Optional Modules

ACC-AAM25 Audio Amplifier Module

An optional second identical audio amplifier can be plugged into connector P3 located in the lower center of the main circuit board in the ACC-25/50 Series. This amplifier also provides 25 watts of power at 25 V_{RMS} and can therefore be used to expand system power to 50 watts (providing dual 25 watt speaker circuits) or it can be used as a backup amplifier. An option module can also be used to convert the 25 V_{RMS} output to 70.7 V_{RMS} .



NOTE: For ease of access, all wiring should be connected to the terminals on the main circuit board terminal blocks TB5, TB6, TB9 and TB10 prior to installing the secondary Audio Amplifier Module.

FC-XRM70 Transformer Module 70.7 V_{RMS}

This optional module plugs into connector P1 of the Audio Amplifier Module and provides conversion from 25 V_{RMS} to 70.7 V_{RMS} at full rated 25 watts output power.

FC-LPS Local Playback Speaker

This optional speaker module plugs into connector P2 located in the lower right section of the ACC-25/50 Series main circuit board. This unit allows reviewing of the digital messages locally without broadcasting over the system speakers. The optional module must be installed in order to take advantage of the Playback feature. It may be temporarily used to test recorded messages. A mounting kit is included for this purpose. The FC-LPS cannot be permanently mounted in the enclosure and must be removed after use.

FC-RM Remote Microphone

The optional microphone module FC-RM, provides general paging capabilities through the remote microphone for an audio system. Announcements can be broadcast over the speaker circuits by depressing the Remote Microphone keyswitch. The FC-MIM Microphone Interface Module must be installed in the ACC-25/50 or ACC-25/50ZS audio panel for connection to the FC-RM (refer to the FC-RM Product Installation Document #51247 for installation information).

An ACC-25/50ZST does not require an FC-MIM since the function of this module is incorporated in the ACC-FFT Fire Fighter Telephone module which is included with the ACC-25/50ZST. The Remote Microphone Module is connected directly to the ACC-FFT Fire Fighter Telephone module (refer to Section “ACC-FFT Fire Fighter Telephone Module (ACC-25/50ZST Only)” on page 55.



NOTE: Paging operations initiated from within the ACC-25/50 Series main panel will override the remote microphone.

ACC-EPM External Page Module

This optional module provides an interface to external non-emergency paging equipment. When activated, a contact closure will switch the external paging equipment into the ACC-25/50 Series speaker circuits if the circuits have not been activated by the ACC-25/50 Series panels for emergency use. Any emergency/fire activation or local paging will override the ACC-EPM input. Paging from non-emergency equipment is prohibited during AC loss condition to preserve battery power.

1.7 Getting Started

This section describes the basic guidelines for setting up the various ACC-25/50 Series systems, assuming that the speaker and FACP cabling has been installed.

1.7.1 ACC-25/50, Requiring up to 50 Watts of Audio Power

- Install backboxes and circuit boards as described in Section 3, “Installation” on page 42.
- Configure the ACC-25/50 for Single Zone operation, if individual speaker circuit control is not required, by setting DIP switch S3 switches 1, 2 and 3 on the ACC-MCB mother board. The factory default setting is Dual Zone output control. Refer to Section 2, “Field Programming” on page 32.
- Record any new voice messages as described in Section 4, “Operating Instructions” on page 63.

1.7.2 ACC-25/50 With ACC-25/50DA(s), Requiring Greater Than 50 Watts of Audio Power

- Connect the Audio Riser and Master Command Bus (for All-Call) cabling between the ACC-25/50 and ACC-25/50DA panels. Refer to Section 5, “Application Examples” on page 80.
- Install backboxes and circuit boards as described in Section 3, “Installation” on page 42.
- Configure the ACC-25/50 for Single Zone operation using DIP switch S3 switches 1, 2 and 3 on the ACC-MCB motherboard. Refer to Section 2, “Field Programming” on page 32. The ACC-25/50DA DIP switches can be left at the default settings.
- Record any new voice messages as described in Section 4, “Operating Instructions” on page 63.

1.7.3 ACC-25/50ZS & ACC-25/50ZST, Requiring up to 50 Watts of Audio Power

- Install backboxes and circuit boards as described in Section 3, “Installation” on page 42.
- Configure the ACC-25/50ZS/T for Single Zone operation using DIP switch S3 switches 1, 2 and 3 on the ACC-MCB motherboard. Refer to Section 2, “Field Programming” on page 32.
- Configure the ACC-ZPM Zone Page Module DIP switch S1 switches 1, 2 and 3 for operation with the FACP. Refer to Section 2, “Field Programming” on page 32 and Section 5, “Application Examples” on page 80.

- Record any new voice messages as described in Section 4, "Operating Instructions" on page 63.
- Program the FACP to operate with the ACC-25/50ZS/T
 - ✓ Enable the ACS serial link or ANN-BUS serial link.
 - ✓ Assign audio zones where applicable (see Section D, "Programmed Activation by FACP" on page 105.)
 - ✓ Assign message numbers (1 - 5) where applicable (see Section D, "Programmed Activation by FACP" on page 105).

1.7.4 ACC-25/50ZS & ACC-25/50ZST, Requiring Greater Than 50 Watts But Less Than 150 Watts

- Install backboxes and circuit boards as described in Section 3, "Installation" on page 42.
- Configure the ACC-25/50ZS/T for Single Zone operation using DIP switch S3 switches 1, 2 and 3 on the ACC-MCB motherboard. Refer to Section 2, "Field Programming" on page 32.
- Configure the ACC-ZPM Zone Page Module DIP switch S1 switches 1, 2 and 3 for operation with the FACP. Refer to Section 2, "Field Programming" on page 32 and Section 5, "Application Examples" on page 80.
- Record any new voice messages as described in Section 4, "Operating Instructions" on page 63.
- Program the FACP to operate with the ACC-25/50ZS/T
 - ✓ Enable the ACS serial link or ANN-BUS serial link.
 - ✓ Assign audio zones where applicable (see Section D, "Programmed Activation by FACP" on page 105).
 - ✓ Assign message numbers (1 - 5) where applicable (refer to Section D, "Programmed Activation by FACP" on page 105).
 - ✓ If Remote FFT annunciation is required, assign ACC address as described in Section D, "Programmed Activation by FACP" on page 105.
- Connect Audio Riser and ACC Control Serial Link cabling between the ACC-25/50ZS(T) and the ACC-25/50DAZS.

Section 2: Field Programming

The AUDIO•COMMAND•CENTER•25/50, AUDIO•COMMAND•CENTER•25/50ZS, and AUDIO•COMMAND•CENTER•25/50ZST can be field programmed using option DIP switches S1, S3 and S5 located in the upper right side of the main circuit board. It is recommended that tone selection, message repeat cycles and background music options be reviewed and approved by the local AHJ. The ACC-25/50ZS and ACC-25/50ZST also have a programming DIP switch located on the ACC-ZPMK Zone Page Module. A Remote Microphone Installed slide switch SW1 is also located on the ACC-FFT module. Refer to the following illustrations for details on DIP switch placement in the ON and OFF positions.



CAUTION: STATIC SENSITIVE DEVICES

IN ORDER TO MINIMIZE RISK OF DAMAGE TO ANY CIRCUITS, DO NOT USE CONDUCTIVE TOOLS WHEN CONFIGURING DIP SWITCHES.

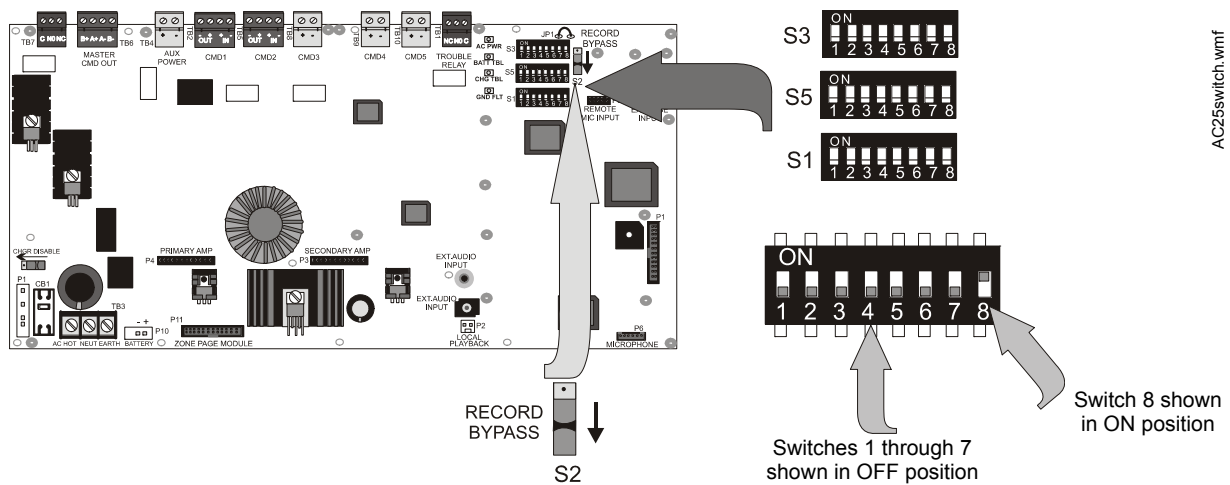

Figure 2.1 Field Programming DIP Switches for ACC-25/50, ACC-25/50ZS, & ACC-25/50ZST

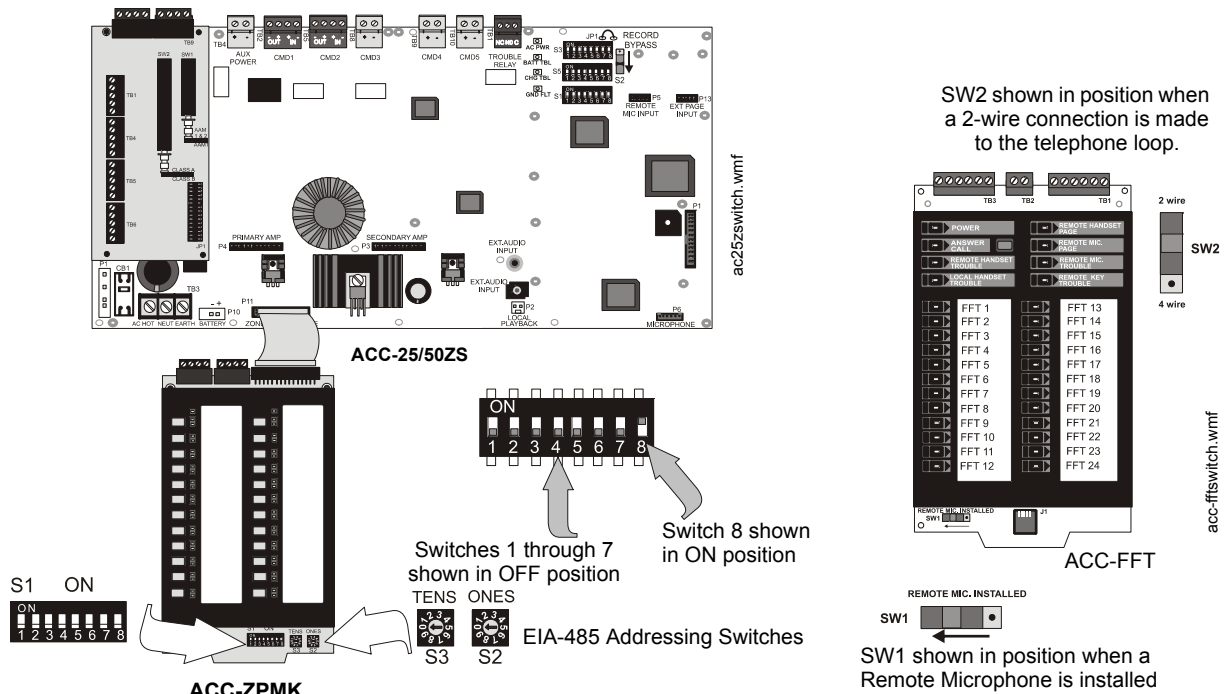

Figure 2.2 Field Programming DIP Switch for ACC-25/50ZS & ACC-25/50ZST Only

The following tables list the ACC-25/50 Series programmable features and the DIP switch settings required to select a particular feature. A detailed description of each feature is presented in the following pages.

S1 DIP Switch	ON	OFF
1 ¹	Enable Temporal Pattern Tone (switches 2 & 3 must be OFF)	Disable Temporal Pattern Tone (factory default) (tone generated as selected by switches 2 & 3)
2 ¹	This switch works in conjunction with switch 3 to determine tone to be generated over speakers	
3 ¹	Tone transmitted before and after message transmission and as backup tone if message fails: 2 OFF, 3 OFF = Steady Tone 2 OFF, 3 ON = Slow Whoop Tone (factory default) 2 ON, 3 OFF = Hi-Lo Tone 2 ON, 3 ON = Chime	
4 ¹	Enable Tone Transmission Before Message (factory default)	Disable Tone Transmission Before Message
5 ¹	Enable Tone Transmission After Message	Disable Tone Transmission After Message (factory default)
6	This switch works in conjunction with switches 7 & 8 to determine number of times message will repeat	
7	This switch works in conjunction with switches 6 & 8 to determine number of times message will repeat	
8	Number of times voice message will repeat: 6 OFF, 7 OFF, 8 OFF = Tone Only, No Voice 6 ON, 7 OFF, 8 OFF = 3 6 OFF, 7 ON, 8 OFF = 4 6 ON, 7 ON, 8 OFF = 6 (factory default) 6 OFF, 7 OFF, 8 ON = 8 6 ON, 7 ON, 8 ON = Infinite (until FACP NAC is reset) All other settings for switches 6, 7 and 8 are invalid and will default to a message repeat of 3 times	

Table 2.1 S1 DIP Switch Settings on ACC-25/50 Series Motherboard (ACC-MCB)

1 Tone selection applies only to Message 1 (Fire Evac). Message 2, Message 3, Message 4, and Message 5 will output only the message.

S5 DIP Switch	ON	OFF
1	not used	
2	not used	
3	Enable Background Music ^{1, 2}	Disable Background Music (factory default)
4	not used	
5	Command Input 1 Activation on Contact Closure	Command Input 1 Activation on NAC polarity reversal (factory default) ³
6	Command Input 2 Activation on Contact Closure	Command Input 2 Activation on NAC polarity reversal (factory default) ³
7	Record from External Audio Input Source	Record from Microphone (factory default)
8	Enable Recording of Messages Record/Playback Key Used for Recording	Disable Recording of Messages Record/Playback Key Used for Playback (factory default)

Table 2.2 S5 DIP Switch Settings on ACC-25/50 Series Motherboard (ACC-MCB)

- 1 NFPA 72 requires that speakers used as alarm notification appliances on fire alarm systems not be used for nonemergency purposes. Consult with the Local AHJ for authorization to use background music. Only 20 watts of power can be supplied per amplifier if background music is enabled.
- 2 Background music is not permitted for the ACC-25/50ZS or ACC-25/50ZST, and is prohibited during AC loss conditions to preserve battery power.
- 3 When CMD1 and CMD2 are configured for reverse polarity, the NAC *cannot* be Coded.

S3 DIP Switch	ON	OFF
1	This switch works in conjunction with switches 2 & 3 to determine Message Control Selection	
2	This switch works in conjunction with switches 1 & 3 to determine Message Control Selection	
3	Message Control Selections (DIP switch settings configure message length and CMD to Amplifier control):	
	<p>1 OFF, 2 OFF, 3 OFF - DUAL ZONE^{1, 2}</p> <ul style="list-style-type: none"> • 60 second message • CMD1³ = message 1 to AAM1⁴ • CMD2 = message 1 to AAM2 <p>1 ON, 2 OFF, 3 OFF - SINGLE ZONE^{5, 6, 7}</p> <ul style="list-style-type: none"> • 30 second message • CMD1 = message 1 to AAM1 & AAM2 • CMD2 = message 2 to AAM1 & AAM2 <p>1 OFF, 2 ON, 3 OFF - SINGLE ZONE^{5, 8}</p> <ul style="list-style-type: none"> • 20 second message • CMD1 = message 1 to AAM1 & AAM2 • CMD2 = message 2 to AAM1 & AAM2 <p>1 ON, 2 ON, 3 OFF - SINGLE ZONE^{5, 8}</p> <ul style="list-style-type: none"> • 15 second message • CMD1 = message 1 to AAM1 & AAM2 • CMD2 = message 2 to AAM1 & AAM2 <p>1 ON, 2 OFF, 3 ON - SINGLE ZONE^{5, 8}</p> <ul style="list-style-type: none"> • 12 second message • CMD1 = message 1 to AAM1 & AAM2 • CMD2 = message 2 to AAM1 & AAM2 	<ul style="list-style-type: none"> • CMD3 = not used • CMD4 = not used • CMD5 = not used <ul style="list-style-type: none"> • CMD3 = not used • CMD4 = not used • CMD5 = not used <ul style="list-style-type: none"> • CMD3 = message 3 to AAM1 & AAM2 • CMD4 = not used • CMD5 = not used <ul style="list-style-type: none"> • CMD3 = message 3 to AAM1 & AAM2 • CMD4 = message 4 to AAM1 & AAM2 • CMD5 = not used <ul style="list-style-type: none"> • CMD3 = message 3 to AAM1 & AAM2 • CMD4 = message 4 to AAM1 & AAM2 • CMD5 = message 5 to AAM1 & AAM2
4	This switch works in conjunction with switch 5 to set the AC Loss Delay time	

Table 2.3 S3 DIP Switch Settings on ACC-25/50 Series Motherboard (ACC-MCB)

S3 DIP Switch	ON	OFF
5	4 OFF and 5 OFF = No AC Loss Delay 4 OFF and 5 ON = 6 Hour Delay 4 ON and 5 OFF = 2 Hour Delay 4 ON and 5 ON = not used (Invalid Setting)	
6	Enable All-Call during Remote Mic. Page ⁸	Disable All-Call during Remote Mic. Page ⁸ - factory default
7	Enable ACC-25/50ZST operation	Enable ACC-25/50 or ACC-25/50ZS operation
8	Only AC Loss Relay will transfer upon an AC loss condition.	The CMD1 & Form-C Trouble Relays will track the AC Loss Relay and transfer upon an AC loss condition.

Table 2.3 S3 DIP Switch Settings on ACC-25/50 Series Motherboard (ACC-MCB)

- 1 Dual Zone operation directs a single message to either or both amplifier circuits (factory default setting).
- 2 Dual Zone is not permitted for ACC-25/50ZS or ACC-25/50ZST.
- 3 CMD1 has the highest priority, CMD5 has the lowest priority.
- 4 AAM1 refers to the first ACC-AAM25 amplifier circuit and AAM2 refers to the second ACC-AAM25 amplifier circuit.
- 5 Single Zone operation directs the same message to both amplifier circuits.
- 6 CMD inputs are not used for activation when ACC-ZPMK is installed with the MS-9200UD, MS-9200UDLS and MS-9600 Version 2.0 or later. 4.7 K End-of-Line resistors must still be connected across CMD3, CMD4 and CMD5.
- 7 When using Distributed Audio Panels, the ACC-25/50 must be configured as single zone.
- 8 This option defaults to ON for the ACC-25/50ZS and ACC-25/50ZST system.

S1 DIP Switch	ON	OFF
1	This switch works in conjunction with switches 2 & 3 to configure for operation with specific FACP	
2	This switch works in conjunction with switches 1 & 3 to configure for operation with specific FACP	
3	1 OFF, 2 OFF, 3 OFF = No FACP, MS-9200UD version 1 or non-ACS FACP connected to ACC-25/50ZS/T- (factory default setting) 1 OFF, 2 OFF, 3 ON = MS-5210UD connected to ACC-25/50ZS/T 1 OFF, 2 ON, 3 OFF = MS-9200 connected to ACC-25/50ZS/T 1 OFF, 2 ON, 3 ON = MS-9600 version 1 connected to ACC-25/50ZS/T 1 ON, 2 OFF, 3 OFF = MS-9600 version 2 or higher connected to ACC-25/50ZS/T 1 ON, 2 OFF, 3 ON = MS-9200UDLS and MS-9200UD version 2 or 3 connected to ACC-25/50ZS/T 1 ON, 2 ON, 3 OFF = ANN-BUS Protocol, MS-9600LS, or MS-9200UDLS version 4 or higher, MS-5UD-3, MS-5UD-7, MS-10UD-3, and MS-10UD-7 version 2 or higher connected to ACC-25/50ZS/T 1 ON, 2 ON, 3 ON = future use	
4	not used (future)	
5	not used (must be set to OFF)	
6	This switch works in conjunction with switches 7 & 8 to set the number of ACC-25/50DAZS panels connected	
7	This switch works in conjunction with switches 6 & 8 to set the number of ACC-25/50DAZS panels connected	
8	6 OFF, 7 OFF, 8 OFF = No ACC-25/50DAZS Distributed Audio Panels connected to ACC-25/50ZS/T 6 OFF, 7 OFF, 8 ON = 1 ACC-25/50DAZS Distributed Audio Panel connected to ACC-25/50ZS/T 6 OFF, 7 ON, 8 OFF = 2 ACC-25/50DAZS Distributed Audio Panels connected to ACC-25/50ZS/T 6 OFF, 7 ON, 8 ON = 3 ACC-25/50DAZS Distributed Audio Panels connected to ACC-25/50ZS/T 6 ON, 7 OFF, 8 OFF = 4 ACC-25/50DAZS Distributed Audio Panels connected to ACC-25/50ZS/T 6 ON, 7 OFF, 8 ON = 5 ACC-25/50DAZS Distributed Audio Panels connected to ACC-25/50ZS/T	

Table 2.4 S1 DIP Switch Settings on ACC-ZPMK (ACC-25/50ZS & ACC-25/50ZST)

2.1 S1 DIP Switch Settings on ACC-25/50 Series Motherboard (ACC-MCB)

- Switch 1 - Temporal pattern generated per ANSI S3.41 when Switch 1 is ON and Switches 2 and 3 are OFF
 - OFF = No temporal pattern - tone generated as selected by Switches 2 and 3 (factory default setting).
 - ON = 3 Cycles of Temporal pattern generated on steady tone. Switches 2 and 3 must be in the OFF position.
- Switches 2 and 3 - used to determine what tone will be transmitted over the speakers before and after the message is transmitted as well as the backup tone to be transmitted if the digital voice generator fails.

SWITCH 2	SWITCH 3	STONE TRANSMITTED BEFORE AND AFTER DIGITAL VOICE MESSAGE
OFF	OFF	STEADY
OFF	ON	SLOW WHOOP (factory default)
ON	OFF	Hi-Lo
ON	ON	CHIME

Table 2.5 Switch Settings for Tones

- Switch 4 - used to determine if the tone selected by S1 switches 2 and 3 will be generated before the message is transmitted:
 - OFF = No tone before message
 - ON = Tone before message (factory default setting)
- Switch 5 - used to determine if the tone selected by S1 switches 2 and 3 will be generated after the message is transmitted:
 - OFF = No tone after message (factory default setting)
 - ON = Tone after message



NOTES: Tone Before/After only applies to Message 1 (Fire Evac). Messages 2 through 5 do not generate a tone before or after the message.

- Switches 6, 7 and 8 - used to determine the number of times the voice message will repeat.

SWITCH 6	SWITCH 7	SWITCH 8	NUMBER OF TIMES TO REPEAT DIGITAL VOICE MESSAGE
OFF	OFF	OFF	Tone Only, No Voice ¹
ON	OFF	OFF	3
OFF	ON	OFF	4
ON	ON	OFF	6 (factory default)
OFF	OFF	ON	8
ON	ON	ON	INFINITE (until FACP trigger is reset)

All other settings for switches 6, 7 and 8 are invalid and will default to a message repeat of 3 times.

Table 2.6 Switch Settings for Message Repeat

- Some jurisdictions require tone evacuate only. This option prevents voice messages from being generated. Verify with local AHJ if voice message is allowed and the number of time the message may be repeated.

2.2 S5 DIP Switch Settings on ACC-25/50 Series Motherboard (ACC-MCB)

- Switch 1 - not used
- Switch 2 - not used
- Switch 3 - controls whether background music can be played over the speakers from the RCA Jack Input.
OFF = Background music disabled (factory default setting)
ON = Background music enabled



NOTES:

1. NFPA 72 requires that speakers used as alarm notification appliances on fire alarm systems not be used for nonemergency purposes. Consult with the Local AHJ for authorization to use background music with the AUDIO•COMMAND•CENTER•25/50. Only 20 watts of power can be supplied per amplifier if background music is enabled.
2. The AUDIO•COMMAND•CENTER•25/50ZS and AUDIO•COMMAND•CENTER•25/50ZST do not support background music.
3. Background music is prohibited during AC loss conditions to preserve battery power.

- Switch 4 - not used
- Switch 5 - used to determine what will activate the Command Input #1.
OFF = Activation on NAC polarity reversal (factory default setting)
ON = Activation on contact closure
- Switch 6 - used to determine what will activate the Command Input #2.
OFF = Activation on NAC polarity reversal (factory default setting)
ON = Activation on contact closure
- Switch 7 - used to determine the source being used to record the digital voice message.
OFF = Record from Microphone (factory default setting)
ON = Record from External Audio Input (RCA Jack or mini PC Jack)
- Switch 8 - used to enable recording of digital voice message.
OFF = Recording not permitted, Record/Playback key used for message playback (factory default) setting)
ON = Recording permitted, Record/Playback key used to record voice message. Switch must be restored to default setting upon completion of recording.

2.3 S3 DIP Switch Settings on ACC-25/50 Motherboard (ACC-MCB)

- Switches 1, 2 and 3 - used to choose the Message Control Selections which determine how the CMD inputs will direct the tones/messages to the ACC-AAM25 audio amplifier circuits. The selections also determine the length of each available message.

Switch 1	Switch 2	Switch 3	Mode	Maximum Length of Each Message	Audio Signal Control				
					CMD1 ¹	CMD2	CMD3	CMD4	CMD5
OFF	OFF	OFF	Dual ² Zone	60 sec.	Message 1 to AAM1 ³	Message 1 to AAM2	not used	not used	not used
ON	OFF	OFF	Single ⁴ Zone	30 sec.	Message 1 to AAM1 & 2	Message 2 to AAM1 & 2	not used	not used	not used

Table 2.7 Switch Settings for Message Control

Switch 1	Switch 2	Switch 3	Mode	Maximum Length of Each Message	Audio Signal Control				
					CMD1 ¹	CMD2	CMD3	CMD4	CMD5
OFF	ON	OFF	Single Zone	20 sec.	Message 1 to AAM1 & 2	Message 2 to AAM1 & 2	Message 3 to AAM1 & 2	not used	not used
ON	ON	OFF	Single Zone	15 sec. ⁵	Message 1 to AAM1 & 2	Message 2 to AAM1 & 2	Message 3 to AAM1 & 2	Message 4 to AAM1 & 2	not used
ON	OFF	ON	Single Zone	12 sec. ⁵	Message 1 to AAM1 & 2	Message 2 to AAM1 & 2	Message 3 to AAM1 & 2	Message 4 to AAM1 & 2	Message 5 to AAM1 & 2

Table 2.7 Switch Settings for Message Control

- 1 CMD1 has the highest priority, CMD5 has the lowest priority.
- 2 Dual Zone operation directs a single message to either or both amplifier circuits (factory default setting)
- 3 AAM1 refers to the first ACC-AAM25 amplifier circuit and AAM2 refers to the second ACC-AAM25 amplifier circuit.
- 4 Single Zone operation directs the same message to both amplifier circuits.
- 5 The factory default evacuation message (length = 17 seconds) must be re-recorded to fit into this time slot.

- Switch 4 - used in conjunction with Switch 5 to select AC Loss Delay time.
- Switch 5 - used in conjunction with Switch 4 to select AC Loss Delay time:
 - 4 OFF and 5 OFF = No AC Loss Delay - immediate reporting (factory default)
 - 4 OFF and 5 ON = 6 hour delay
 - 4 ON and 5 OFF = 2 hour delay
 - 4 ON and 5 ON = not used (invalid setting)
- Switch 6 - used for All-Call Paging from Remote Microphone
 - OFF = disable All-Call paging during page from Remote Microphone (factory default setting)
 - ON = enable All-Call paging during page from Remote Microphone
- Switch 7 - used to select audio panel configuration
 - OFF = ACC-25/50 or ACC-25/50ZS
 - ON = ACC-25/50ZST
- Switch 8 - used to enable/disable transferring of Trouble Relay/CMD1 trouble contacts during AC loss
 - OFF = CMD1 & Trouble Relay contacts track the AC Loss Relay and transfer upon AC loss condition
 - ON = Only the AC Loss Relay contacts will transfer upon AC loss condition

2.4 S2 - Record Bypass Switch on ACC-25/50 Series Motherboard (ACC-MCB)

This switch, when placed in the down position, prevents accidental erasure of stored voice messages. See “Record/Playback Button - Record Customized Messages” on page 64 for additional information.

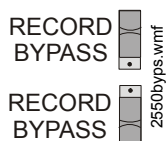

UP Position = The stored digital voice message may be overwritten with a new one.



Down Position = The stored digital voice message can not be overwritten (factory default setting).

2.5 S4 - Battery Charger Switch on ACC-25/50 Series Motherboard

This switch controls whether the ACC-25/50 Series will charge the system batteries or if an external battery charger will be used.

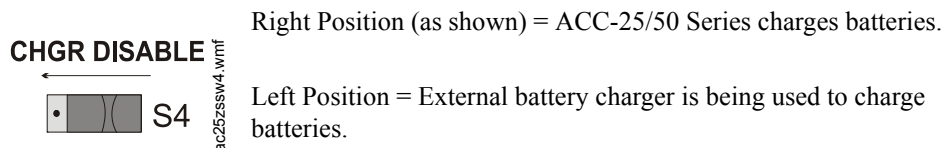

NOTES: The ACC-25/50 Series still indicates battery fault conditions even when internal battery charger is not used.

2.6 SW1 - Remote Microphone Installed Switch on ACC-FFT

This switch is used to indicate if the remote microphone is connected to the ACC-FFT module.

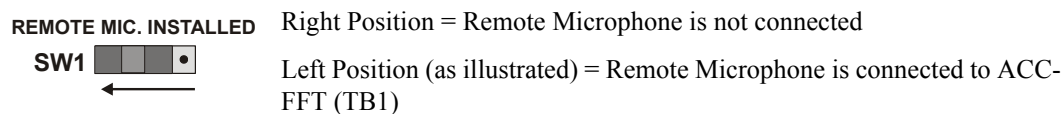

NOTES: If SW1 is set to the left position and the Remote Microphone is not installed, a fault condition will be indicated.

2.7 SW2 - 2 Wire/4 Wire Connection on Telephone Loop

This switch is used to configure 2 Wire (Class B) or 4 Wire (Class A) connections to the telephone loop.

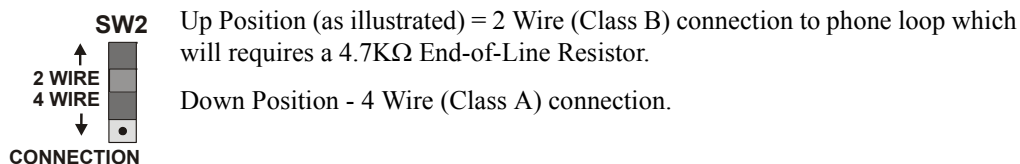

2.8 ACC-ZPMK Zone Page Module (ACC-25/50ZS & ACC-25/50ZST)

The ACC-ZPMK Zone Page Module has a DIP switch S1 for field programming the ACC-25/50ZS and ACC-25/50ZST and two rotary address switches S2 and S3 which are used to set the EIA-485 address of the module for communication with an FACP over the ACS link.

2.8.1 S1 DIP Switch Settings on ACC-ZPMK

- Switches 1, 2 and 3 are used to configure the ACC-25/50ZS/T for operation with a specific FACP as shown in the following table:

SWITCH 1	SWITCH 2	SWITCH 3	CONFIGURED FOR OPERATION WITH FOLLOWING FIRE ALARM CONTROL PANEL
OFF	OFF	OFF	MS-9200UD version 1 or non-ACS/ANN-BUS FACP connected (factory default setting)
OFF	OFF	ON	ACS Protocol: MS-5210UD
OFF	ON	OFF	ACS Protocol: MS-9200
OFF	ON	ON	ACS Protocol: MS-9600 version 1
ON	OFF	OFF	ACS Protocol: MS-9600 version 2
ON	OFF	ON	ACS Protocol: MS-9200UDLS or MS-9200UD version 2 or 3
ON	ON	OFF	ANN-BUS Protocol: MS-9600LS Version 4 or higher MS-9200UDLS Version 4 or higher MS-5UD-3, MS-5UD-7, MS-10UD-3 & MS-10UD-7 Version 2 or higher
ON	ON	ON	future use

Table 2.8 FACP Configuration

- Switch 4 - not used (future)
- Switch 5 - not used (must be set to OFF)
- Switches 6, 7 and 8 - used to set the number of ACC-25/50DAZS Distributed Audio Panels connected to the ACC-25/50ZS or 25/50ZST as shown in the following table:

SWITCH 6	SWITCH 7	SWITCH 8	NUMBER OF ACC-25/50DAZS DISTRIBUTED AUDIO PANELS CONNECTED TO ACC-25/50ZS or 25/50ZST
OFF	OFF	OFF	No ACC-25/50DAZS panel connected
OFF	OFF	ON	1 ACC-25/50DAZS panel connected
OFF	ON	OFF	2 ACC-25/50DAZS panels connected
OFF	ON	ON	3 ACC-25/50DAZS panels connected
ON	OFF	OFF	4 ACC-25/50DAZS panels connected
ON	OFF	ON	5 ACC-25/50DAZS panels connected
ON	ON	OFF	invalid
ON	ON	ON	invalid

Table 2.9 Quantity of ACC-25/50DAZS Panels Connected

2.8.2 S2 and S3 Addressing Rotary Switches

Two addressing switches are located at the bottom right of the ACC-ZPMK Zone Page Module. The switches are used to set the ACS (EIA-485) address of the ACC-ZPMK to allow communication between it and the FACP. This communication link allows the FACP to control speaker zones under program control.

The ACC-ZPMK must be set to address 01 to communicate with the FACP. To set the address, use a small nonconductive flat-blade screw driver to turn the switch dial so the arrow points to the correct address number. The factory default setting is S3 = 0 and S2 = 0. The following illustration shows the switches set for address 01 with S3 (Tens) set to 0 and S2 (Ones) set to 1.

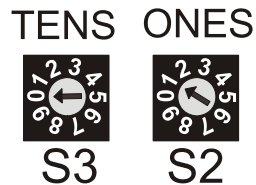

Figure 2.3 ACC-ZPMK Addressing Switches

acczpmadd.wmf

2.9 ACC-ZSM Zone Splitter Module (ACC-25/50ZS & ACC-25/50ZST)

Two switches on the ACC-ZSM Zone Splitter Module are used to configure the speaker circuits connected to it.

- SW1 - used to configure the circuits for split amplifier application. Setting the switch to the AAM 1 & 2 position directs the audio from Amplifier 1 to the first two Class A circuits or first four Class B circuits, and the audio from Amplifier 2 to the next two Class A circuits or next four Class B circuits. Setting the switch to the AAM1 position sends the audio from Amplifier 1 to all circuits.
- SW2 - used to configure all circuits for Class A (Style Z) or Class B (Style Y) operation.

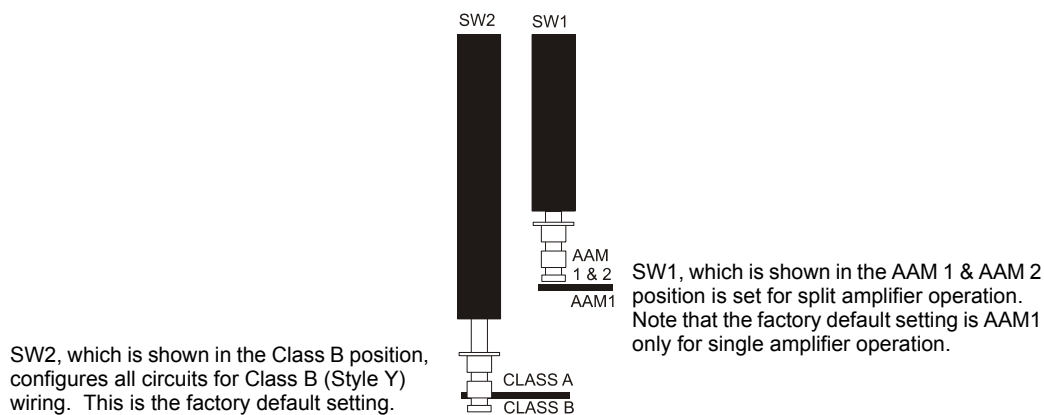

acczsmw1.wmf

Section 3: Installation

3.1 Mounting Options

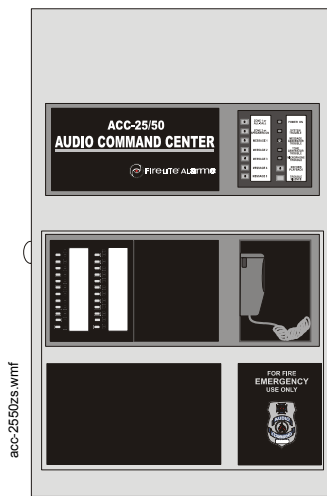

Figure 3.1 ACC-25/50ZS Cabinet

All wiring should be in accordance with the National and/or Local codes for fire alarm systems.

The cabinet may be surface mounted. The door is removable during the installation period by opening and lifting it off the hinges. The cabinet mounts using two key slots at the top of the backbox and two additional 0.250" diameter holes located at the bottom.

Carefully unpack the system and check for shipping damage. Mount the cabinet in a clean, dry, vibration-free area where extreme temperatures are not encountered. The area should be readily accessible with sufficient room to easily install and maintain the panel. Locate the top of the cabinet approximately five feet above the floor with the hinge mounting on the right. Determine the number of conductors required for the devices to be installed. Sufficient knockouts are provided for wiring convenience. Select the appropriate knockout(s) and pull the required conductors into the box. Note that knockouts are also located on the back of the cabinet.

3.2 Backbox Installation

Surface Mounting



CAUTION: STATIC SENSITIVE COMPONENTS

THE CIRCUIT BOARD CONTAINS STATIC-SENSITIVE COMPONENTS. ALWAYS GROUND YOURSELF WITH A PROPER WRIST STRAP BEFORE HANDLING ANY BOARDS SO THAT STATIC CHARGES ARE REMOVED FROM THE BODY. USE STATIC SUPPRESSIVE PACKAGING TO PROTECT ELECTRONIC ASSEMBLIES.

1. Open the door and lift the door off the pin hinges.
2. Remove the main circuit board and transformer from the backbox before installation. Set the board and transformers aside in a safe, clean place. *Avoid static discharge which may damage static sensitive components on the board.*
3. Mark and predrill holes for the top two backbox keyhole mounting bolts using the dimensions shown.
4. Install two upper fasteners in the wall with the screw heads protruding.
5. Using the upper 'keyholes', mount the backbox over the two screws.
6. Mark and drill the lower two holes.
7. Install the remaining fasteners and tighten all fasteners to complete backbox mounting.
8. Carefully reinstall the main circuit board and transformer, using appropriate precautions to prevent damage to components due to static discharge.

Draw wires through the respective knockout locations.

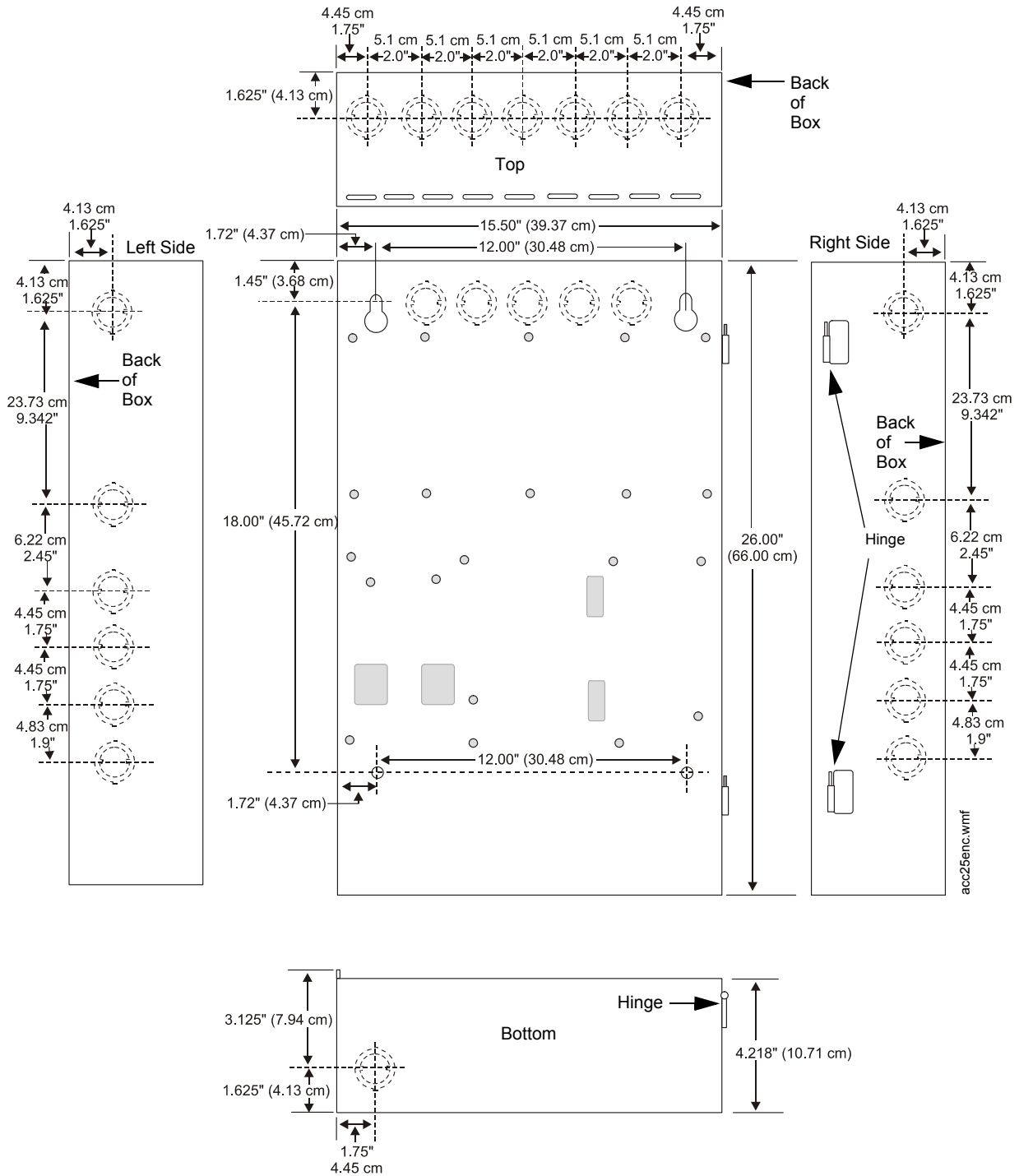

Figure 3.2 Cabinet Dimensions & Knockout Locations

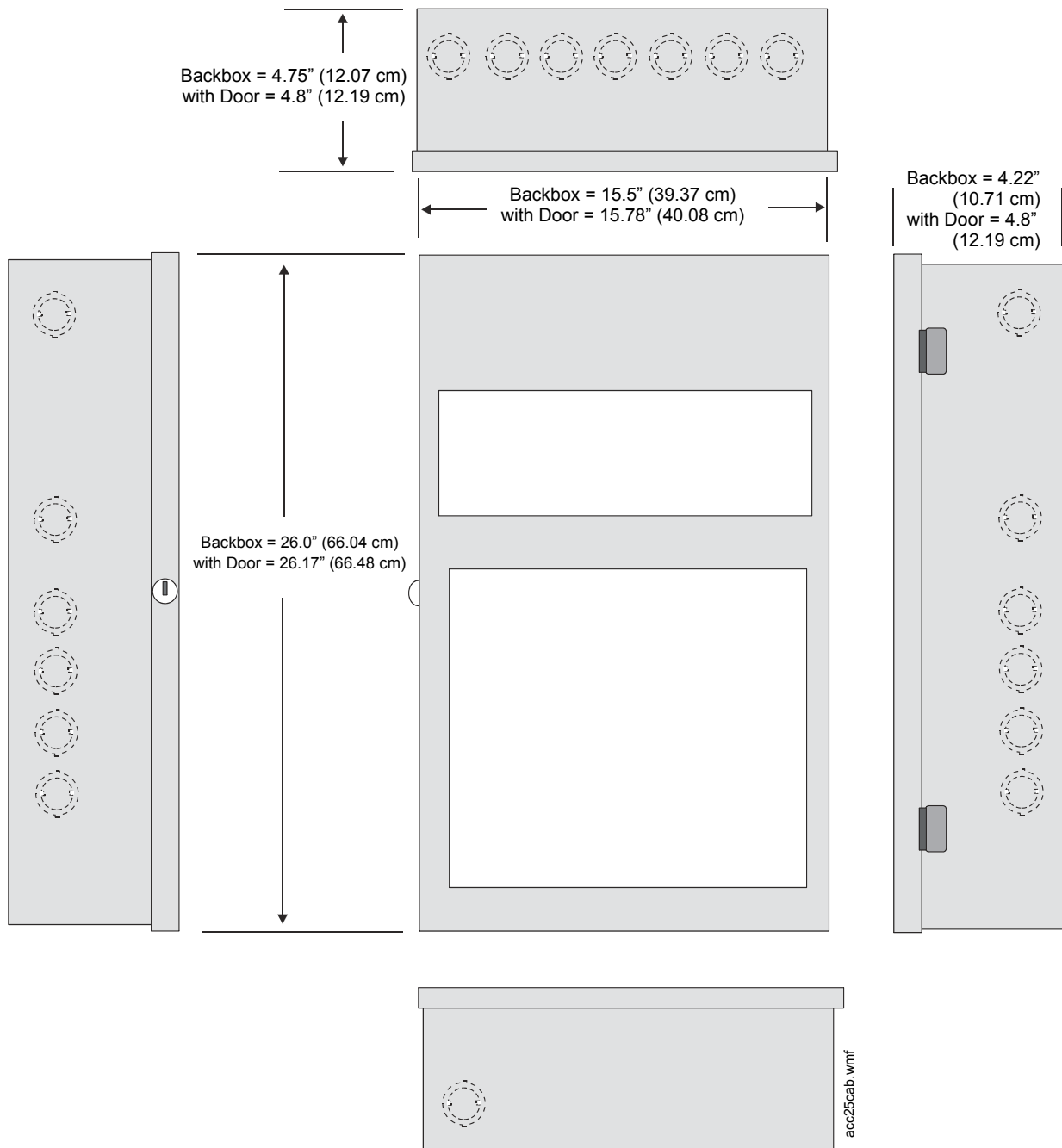

Figure 3.3 ACC-25/50 Series Backbox and Battery Box

3.2.1 Transformer Installation

**CAUTION: DISCONNECT POWER**

BEFORE INSTALLING ANY MODULES OR CABLES, MAKE CERTAIN ALL POWER (AC AND DC) HAS BEEN REMOVED.

1. Locate two threaded mounting studs and two mounting slots in the bottom left corner of the backbox (refer to backbox illustration below).
2. Position the Transformer Assembly with the bottom mounting brackets in the mounting slots and the top brackets on mounting studs, with cable assembly oriented to the top as illustrated below.
3. Secure the Transformer to the studs with the two supplied nuts. Do not tighten one of the nuts until the next step.
4. Connect a wire from a solid earth ground to one of the Transformer mounting studs and tighten the nut. This connection is necessary in order to provide proper lightning and transient protection for the panel.
5. Plug Transformer cable assembly into connector P1 which is located in the lower left side of the main circuit board. Note that the Transformer cable connector is keyed to prevent incorrect connection.
6. Complete the installation by connecting the AC power wires to Hot, Neutral and Earth terminals of TB3 on the main circuit board.
7. If batteries are being used, connect the batteries (18 AH maximum) to connector P10 located to the bottom left of the main circuit board.
8. Apply power to the panel.

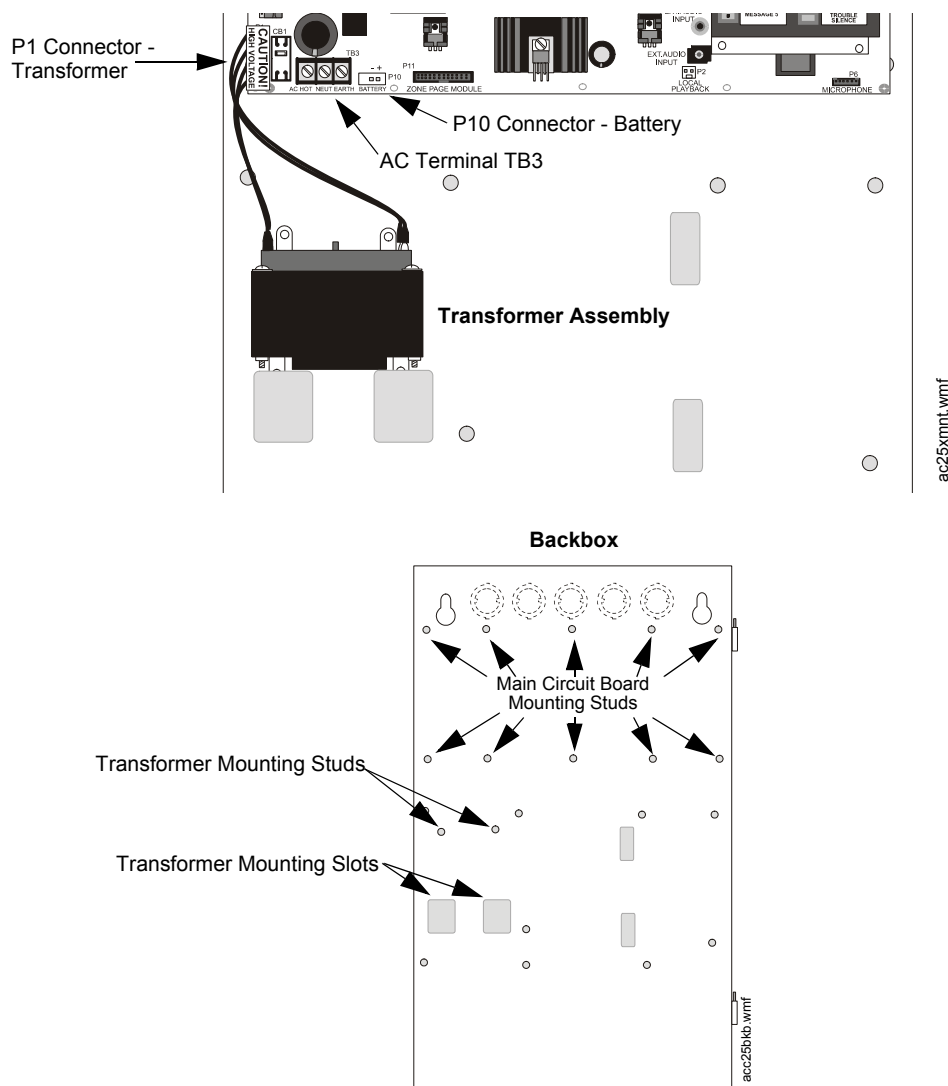

Figure 3.4 Installation of Power Supply Transformer

3.3 Operating Power



WARNING: RISK OF EQUIPMENT DAMAGE AND PERSONAL INJURY

SEVERAL DIFFERENT SOURCES OF POWER CAN BE CONNECTED TO THIS PANEL. DISCONNECT ALL SOURCES OF POWER BEFORE SERVICING. THE PANEL AND ASSOCIATED EQUIPMENT MAY BE DAMAGED BY REMOVING AND/OR INSERTING CARDS, MODULES OR INTERCONNECTING CABLES WHILE THIS UNIT IS ENERGIZED. BE SURE TO OBSERVE PROPER GROUNDING AND HANDLING PROCEDURES.

AC Power and Earth Ground Connection

Primary power source for the ACC-25/50, ACC-25/50ZS, and ACC-25/50ZST is 120 VAC, 60 Hz, 1.5 amps. Overcurrent protection for this circuit must comply with Article 760 of the National Electrical Code (NEC) and/or local codes. Make certain that the AC mains circuit breaker is off before making any wiring connections between the mains and the panel. Run a pair of wires (with ground conductor) from the protected premises main breaker box to TB3 of the main circuit board.

Use 14 AWG (1.6 mm O.D.) or heavier gauge wire with 600V insulation. No other equipment may be connected to this circuit and it may not contain any power disconnect devices. A separate Earth Ground connection must be made to ensure proper panel operation and lightning and transient protection. Connect the Earth Ground wire (minimum 14 AWG) to one of the transformer mounting studs. Do not use conduit for the Earth Ground connection since this does not provide reliable protection.

Secondary Power Source (Batteries)



WARNING: RISK OF PERSONAL INJURY

BATTERY CONTAINS SULFURIC ACID WHICH CAN CAUSE SEVERE BURNS TO THE SKIN AND EYES AND CAN DESTROY FABRICS. IF CONTACT IS MADE WITH SULFURIC ACID, IMMEDIATELY FLUSH THE SKIN OR EYES WITH WATER FOR 15 MINUTES AND SEEK IMMEDIATE MEDICAL ATTENTION.

Observe polarity when connecting the batteries. Connect the battery cable to P10 on the main circuit board, using the plug-in connector and cable provided. The battery charger is current-limited and capable of recharging sealed lead acid type batteries (See Figure 3.5 for battery orientation). The charger shuts off when the system is in alarm. page 98 for calculation of the correct battery rating.

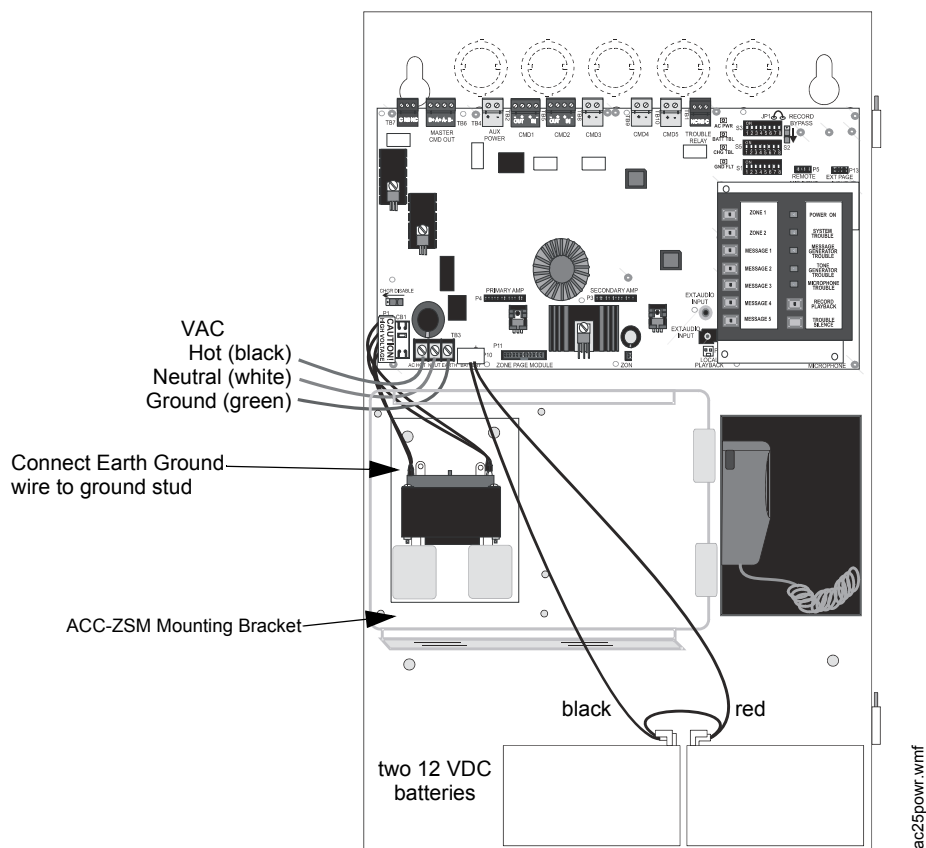

Figure 3.5 Operating Power Connections

3.4 Auxiliary DC Power Output Connections

The Special Application Auxiliary DC power output is power-limited.

Special Application Power (35 mA @ 24 VDC) is nonresettable power suitable for powering control modules and End-of Line Power supervision relays. See Device Compatibility Document for compatible devices.

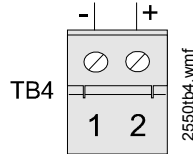

Figure 3.6 Auxiliary Power Connection

3.5 Input/Initiating Circuits

The ACC-25/50 Series has five Command Input circuits, which are used to activate the panel amplifiers which, in turn, transmit an audio signal over the system speakers. All field wiring for the circuits is power-limited and supervised for opens and ground faults. Note that zero impedance to ground will cause a ground fault.

CMD1 and CMD2 Command Input circuits can be independently field programmed to be triggered by a contact closure or by the reverse polarity of a Notification Appliance Circuit.

IMPORTANT! When CMD1 and CMD2 are configured for reverse polarity, the NAC cannot be Coded.

Input and output terminals are provided for CMD1 and CMD2 to allow placement of the ACC-25/50 Series anywhere along a Notification Appliance Circuit allowing nondedicated use of host FACP NAC for triggering. CMD1 has relay contacts (maximum current 2.0 amps) before the out terminals which will open the outgoing NAC circuit during a ACC-25/50 trouble condition (AC loss is programmable as described for switch 8 in Table 2.3 on page 34). This causes a NAC trou-

ble at the host FACP. Note that CMD1 and CMD2 configurations can be independently set so that both circuits are triggered by the same type of input or by different types of inputs (see Figure 3.7 on page 49).

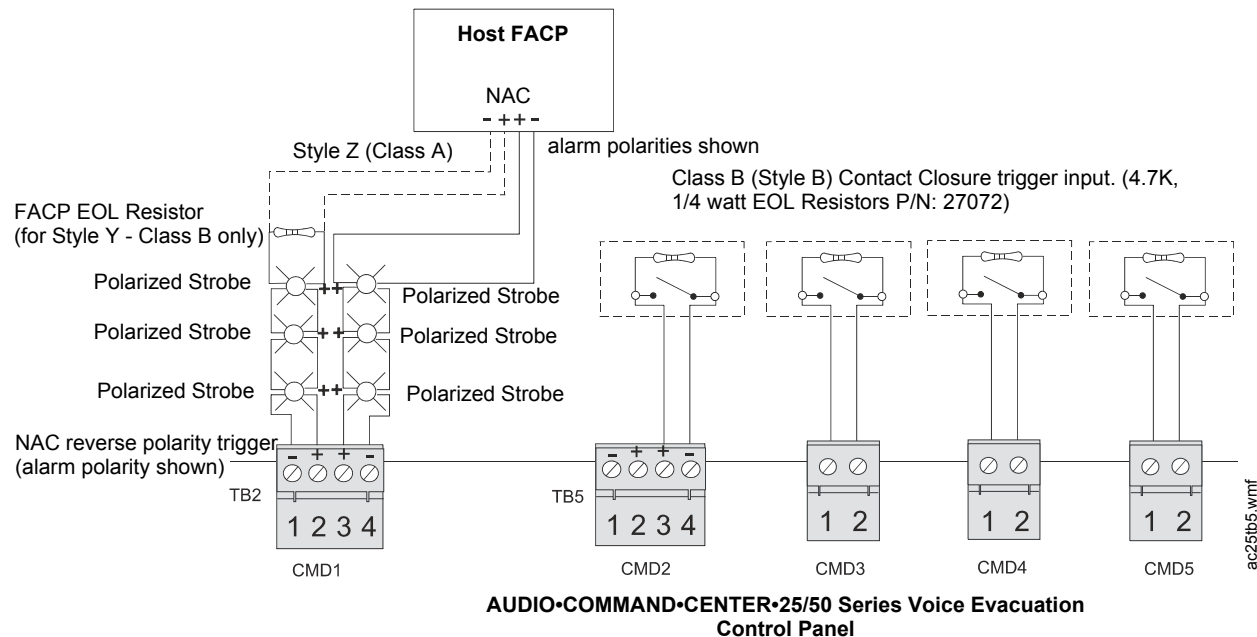

Figure 3.7 Command Input Circuits

CMD3, CMD4 and CMD5 Command Input circuits are triggered by a contact closure only. Each Command input will activate various messages and amplifiers depending on the Message Control selection configured by S3 DIP switches 1, 2 and 3 (see Table 2.7 on page 37).

3.6 Output Circuits

3.6.1 Master Command Bus Output

The Master Command Output is a 24 VDC reverse polarity output (TB6) which can be used as an All-Call trigger for the Audio Command Center Distributed Audio panel. Refer to the *ACC-25/50DA manual*, Document #52265 for additional information. The Master Command Output may activate during emergency or nonemergency paging. See “S3 DIP Switch Settings on ACC-25/50 Motherboard (ACC-MCB)” on page 37.

When connecting the Master Command Output of the main panel to the Master Command Inputs of other devices, the wiring must be supervised by a 4.7K EOL resistor connected across the out terminals of Master Command Input #1 on the last panel for Style Y (Class B) installations. For Style Z (Class A) installations, connect the return wires to the A+ and A- terminals on TB6.

In Example 1 illustrated below, the ACC-25/50 Series panel will trigger the ACC-25/50DA(s) when All-Call is activated for emergency or general paging.

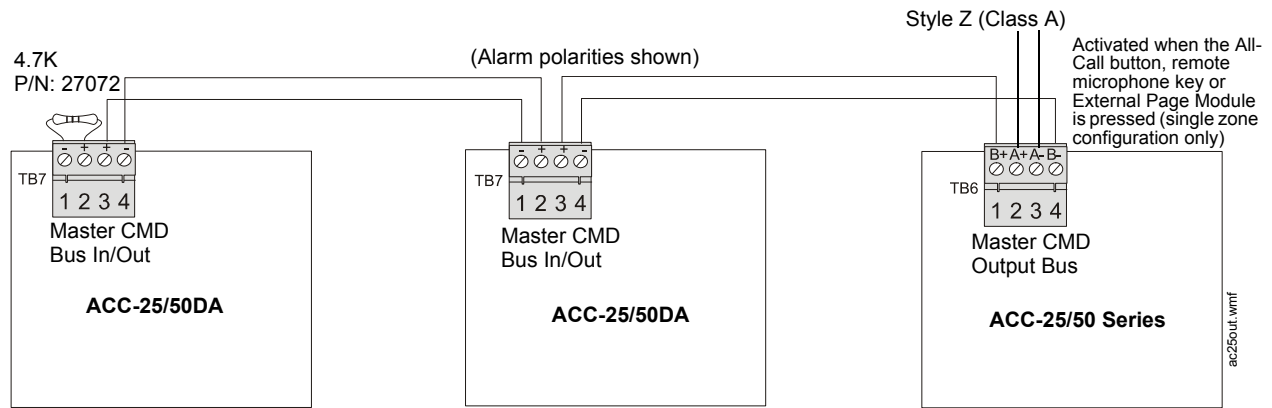
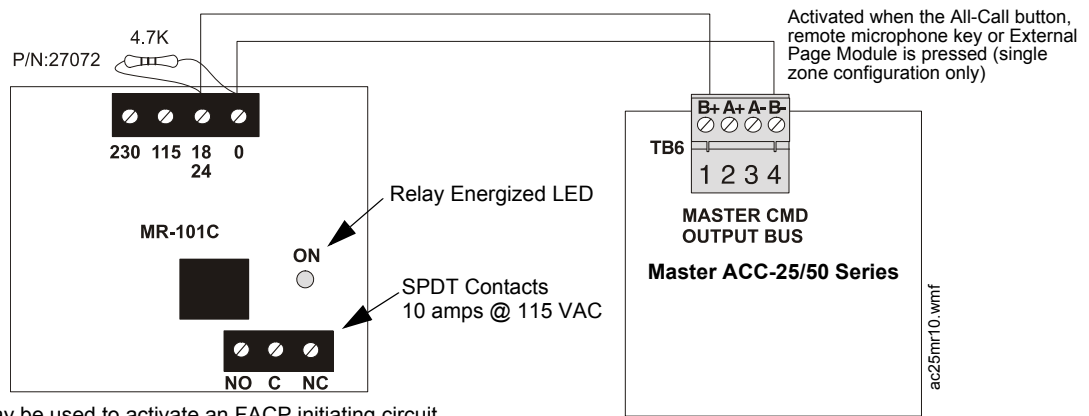

Figure 3.8 Example 1 - Activating Multiple ACC-25/50DAs with Master CMD Output Bus

The maximum line resistance from the main ACC-25/50 Series to the last ACC-25/50DA is 200 ohms (100 ohms per conductor).



Relays may be used to activate an FACP initiating circuit.
CAUTION! All wiring to relay must be in same room within 20 feet of FACP and in conduit.

Figure 3.9 Example 2 - Activating MR-101C (or MR-201C) with Master CMD Output Bus

The MR-101C (one Form-C relay) and MR-201C (two Form-C relays), which are manufactured by Air Products and Controls, include an enclosure.

3.6.2 Trouble Relay - TB1

The main circuit board provides a Form-C Trouble relay, for independent monitoring, rated for 2.0 amps @ 30 VDC (resistive) and 0.6 amp @ 30 VAC (resistive). This relay is 'fail safe', meaning that it is normally energized. Should system power shut off, this relay will deenergize, transferring its contacts. The Trouble Relay can be programmed to track the AC Loss Relay and transfer on AC loss conditions or ignore AC loss conditions (refer to switch 8 in Table 2.3 on page 34).

Note: Relay connections may be power-limited or nonpower-limited, provided that 0.25" spacing is maintained between conductors of power-limited and nonpower-limited circuits. Refer to Section "UL Power-limited Wiring Requirements" on page 56.

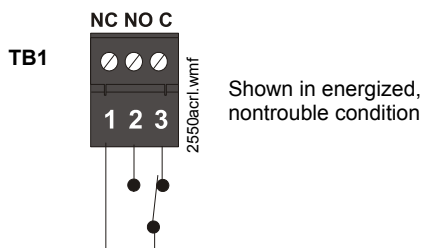

Figure 3.10 Trouble Relay

3.6.3 AC Power Loss Relay - TB7

The main circuit board provides a Form-C AC Power Loss relay rated for 2.0 amps @ 30 VDC (resistive) and 0.6 amps @ 30 VAC (resistive).

Note: Relay connections may be power-limited or nonpower-limited, provided that 0.25" spacing is maintained between conductors of power-limited and nonpower-limited circuits. Refer to Section "UL Power-limited Wiring Requirements" on page 56.

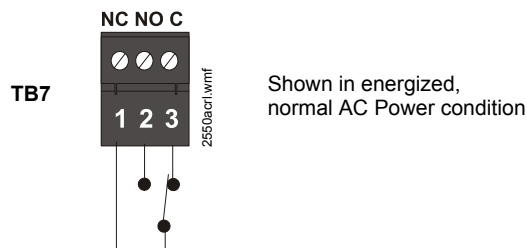

Figure 3.11 AC Power Loss Relay

3.6.4 Notification Appliance Circuit (Speakers)

Each Amplifier Module provides one Notification Appliance Circuit for speakers. The circuit can be wired Style Y (Class B) or Style Z (Class A). Each supervised and power-limited circuit is capable of 25 watts of power. The maximum total capacitance for each speaker circuit cannot exceed 250 uF. Refer to the Fire•Lite Device Compatibility Document for a listing of compatible speakers.



CAUTION: OBSERVE POLARITY

MATCH PROPER POLARITY CONNECTIONS TO FIELD WIRING AND SPEAKERS. POLARITY SHOWN IS IN THE STANDBY AND ALARM CONDITIONS.

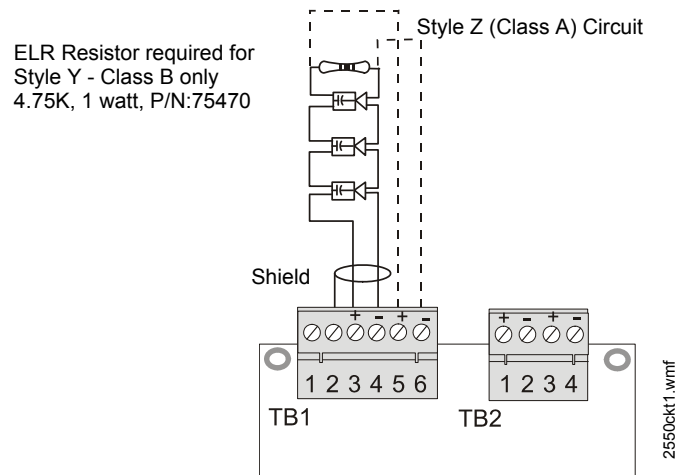

Figure 3.12 Speaker Circuit Connections

Shielded cable is not required, however, shielded cable will reduce RFI/EMI emissions and susceptibility. For additional information, refer to “Wiring Requirements” on page 104.

3.6.5 ACC-ZPMK Zone Page Module - ACS Link (ACC-25/50ZS & ACC-25/50ZST)

The ACC-ZPMK Zone Page Module provides push button control and annunciation of the speaker circuits connected to the ACC-ZSM Zone Splitter Module. The LEDs associated with each speaker circuit will display the circuit status, indicating when the circuit has been manually activated or disabled as well as circuit troubles. In addition, they will indicate speaker activation under FACP program control. In order to provide program control, an ACS (EIA-485) link must be established between the ACC-ZPMK and FACP. This is accomplished by wiring TB1 on the Zone Page Mod-

ule to the ACS terminal on the FACP. Circuit wiring requires a ferrite bead as illustrated in Figure 3.13.

Note that the ACC-ZPMK must be set to address 01 in order to communicate with the FACP.

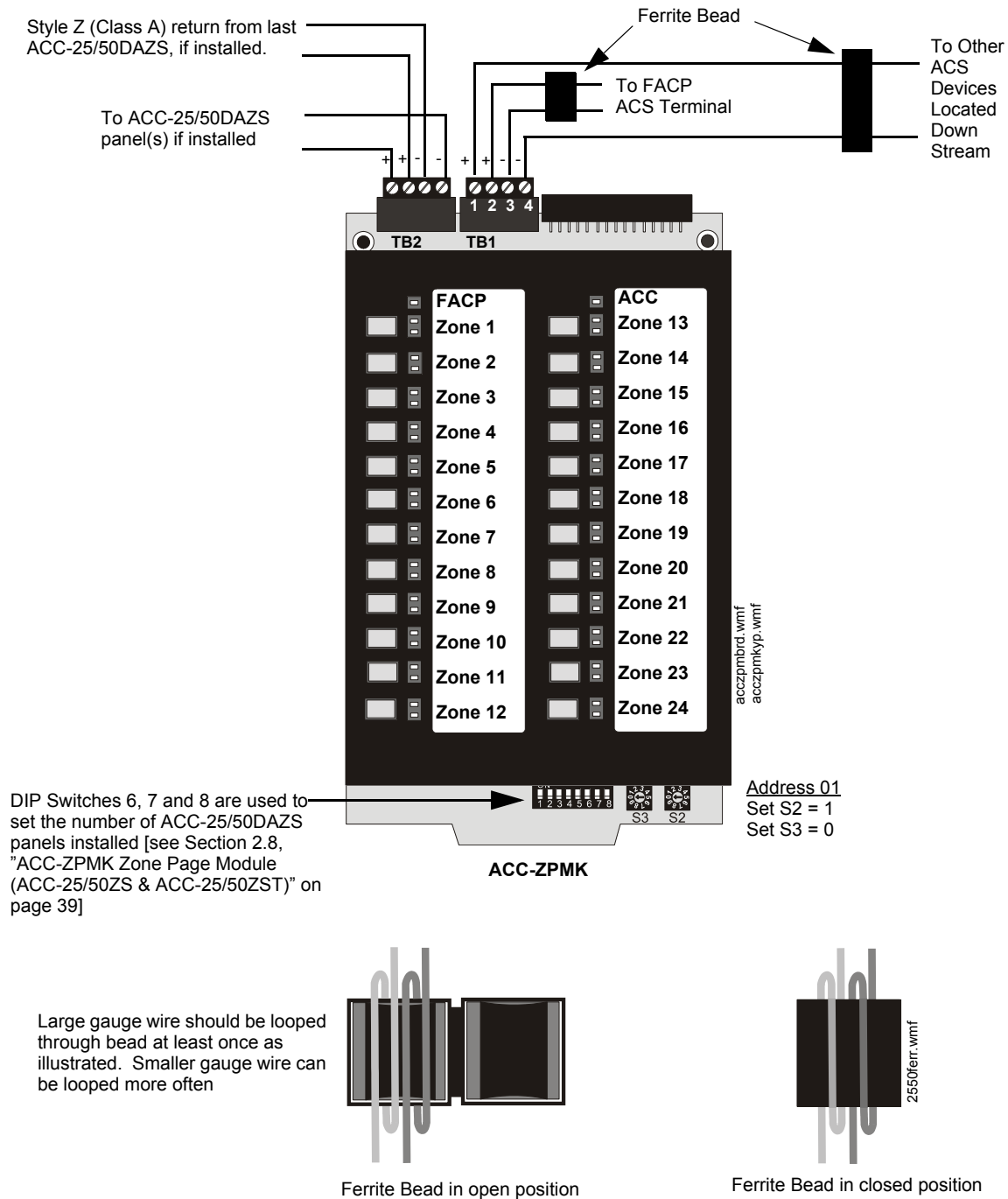

Figure 3.13 Zone Page Module

3.6.6 ACC-ZSM Zone Splitter Module (ACC-25/50ZS & ACC-25/50ZST)

The ACC-ZSM Zone Splitter Module provides connections for four Style Z (Class A) or eight Style Y (Class B) speaker circuits. Circuits are configured by setting switch SW2 on the ACC-ZSM to the Class A or Class B position (refer to Section “ACC-ZSM Zone Splitter Module (ACC-25/50ZS & ACC-25/50ZST)” on page 41).

CAUTION! For correct supervision in the split amplifier configuration, ACC-ZSM TB2 pins 1 & 2 must connect to ACC-AAM25 #1 and ACC-ZSM TB9 pins 1 & 2 must connect to ACC-AAM25 #2

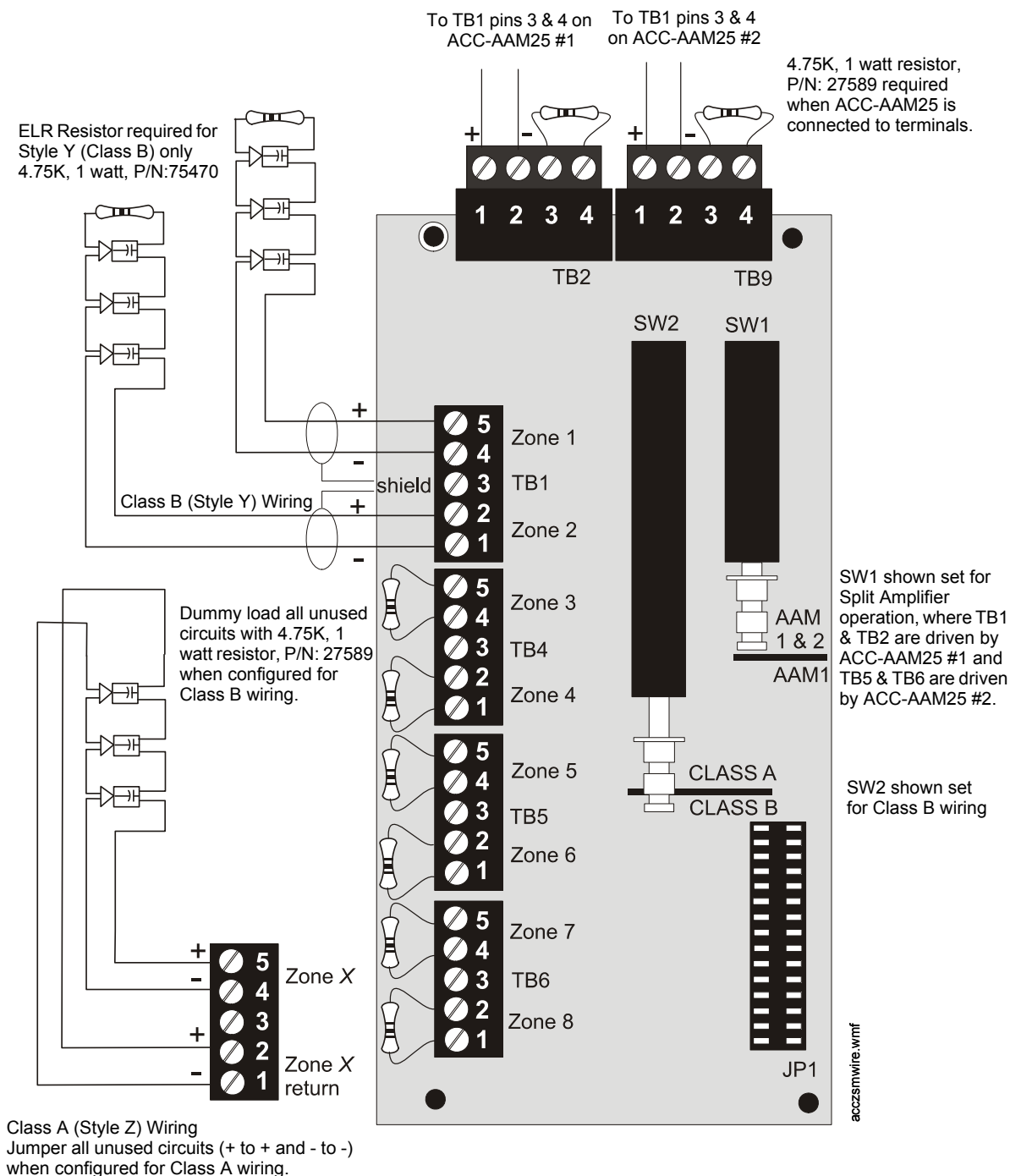

Figure 3.14 Zone Splitter Module

3.6.7 ACC-FFT Fire Fighter Telephone Module (ACC-25/50ZST Only)

The ACC-FFT provides connection for a single Style Y (Class B) or Style Z (Class A) telephone audio circuit. In addition, a terminal block is provided for connection to an FC-RM Remote Microphone module. A terminal block is also provided for connection to the Keyswitch on an RPJ-F Remote Page Jack which allows remote paging by a Remote Telephone (FHS-F). If an addressable FACP is installed, a monitor module can be used to monitor the connection of Fire-Fighter Telephones (FHS-F) into the FPJ-F or RPJ-F, which is then displayed on the ACC-FFT keypad.

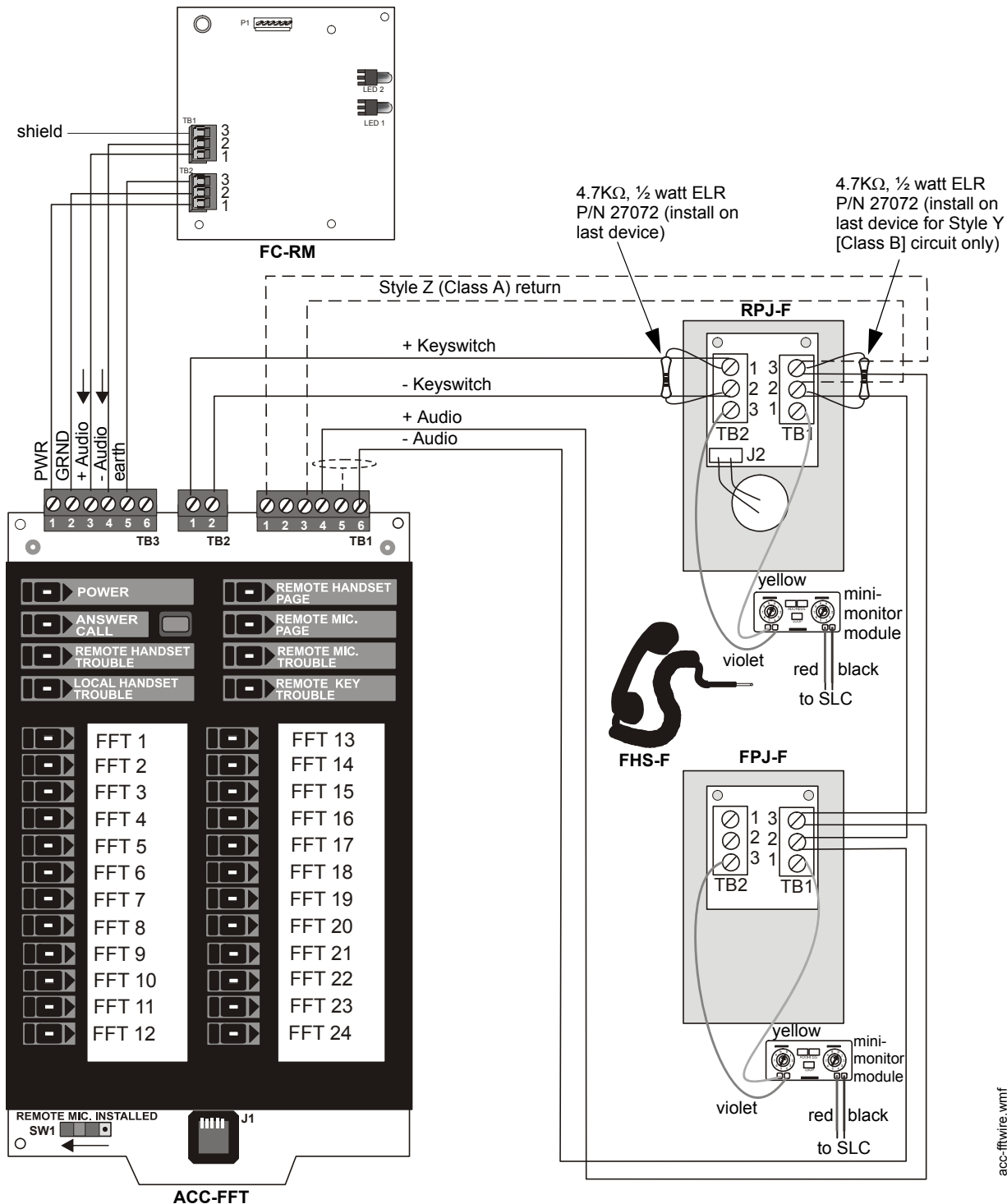
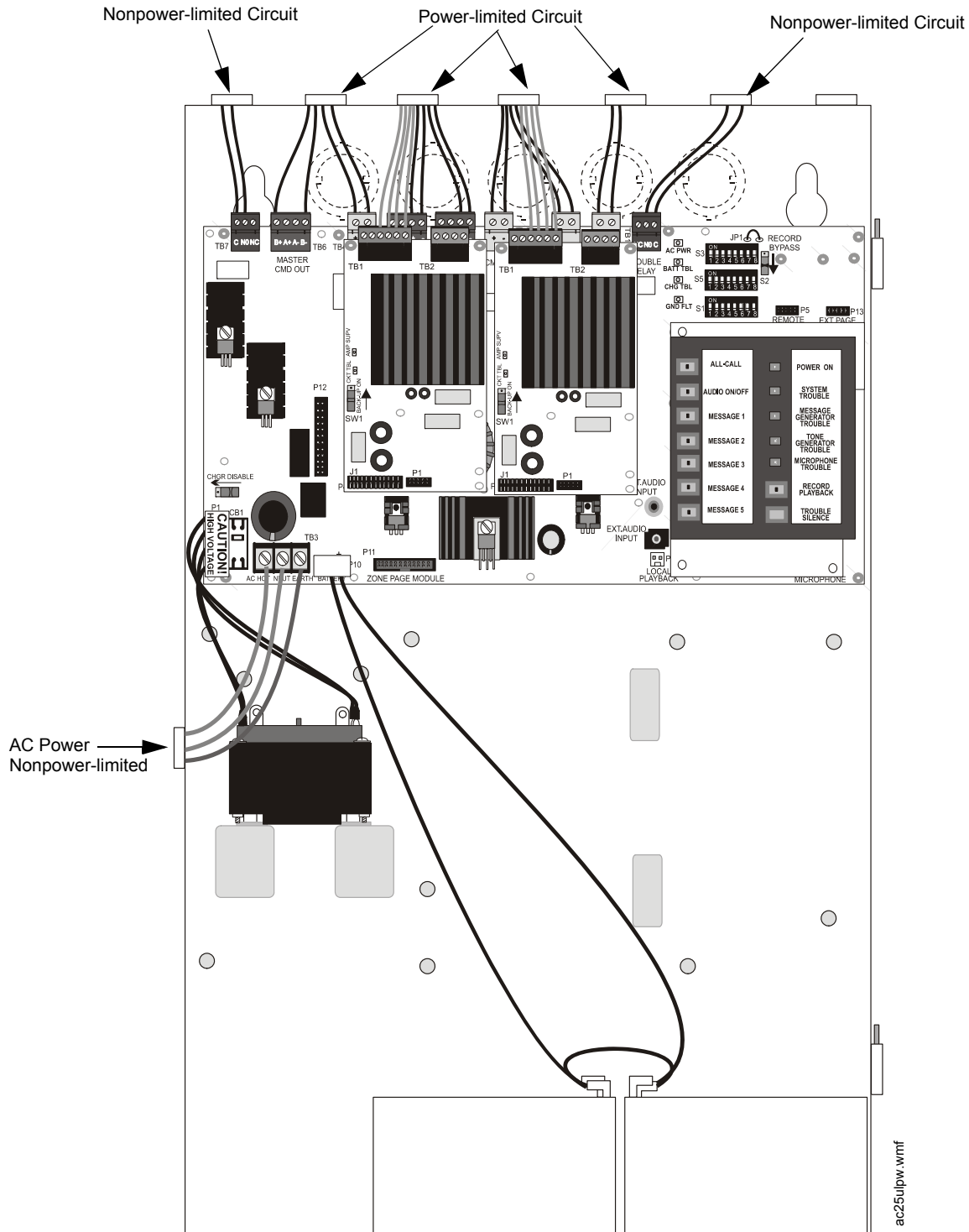

Figure 3.15 ACC-FFT Fire Fighter Telephone Module

3.7 UL Power-limited Wiring Requirements

Power-limited and nonpower-limited circuit wiring must remain separated in the cabinet. All power-limited circuit wiring must remain at least 0.25" away from any nonpower-limited circuit wiring. Furthermore, all power-limited and nonpower-limited circuit wiring must enter and exit the cabinet through different knockouts and/or conduits. A typical wiring diagram for the AUDIO•COMMAND•CENTER•25/50 with two speaker circuits is shown below.

Figure 3.16 Typical Wiring Diagram for UL Power-limited Requirements



ac25upw.wmf

3.8 Installation of Option Modules

3.8.1 Audio Amplifier Module (ACC-AAM25)

The optional audio amplifier module is identical to the module provided with the factory standard panel configuration. It can be used to provide a second 25 watt speaker circuit, increasing the total ACC-25/50 power to 50 watts, or it can be used as a backup amplifier. LEDs on the amplifier module are for Amp Supervision (green - indicates amp functional) and Circuit Trouble (yellow - indicates wiring fault or amplifier fail). Connector J1 of the audio amplifier module plugs into connector P3 located at the bottom center of the main circuit board.



CAUTION: DISCONNECT POWER

BEFORE INSTALLING ANY MODULES OR CABLES, MAKE CERTAIN ALL POWER (AC AND DC) HAS BEEN REMOVED AND BE SURE TO OBSERVE PROPER GROUNDING AND HANDLING PROCEDURES.

1. For ease of access, all wiring should be connected to the terminals on the main circuit board terminal blocks TB1, TB9 and TB10 prior to installing the secondary Audio Amplifier Module.
2. Remove mounting screw shown, from the main circuit board, and save (refer to illustration below).
3. Install one supplied metal standoff in location from which mounting screw was removed in Step 2.
4. Install the Audio Amplifier Module by carefully aligning the amplifier's J1 connector with the P3 connector on the main circuit board. Press the Module securely into place making certain not to bend or break any connector pins.
5. Secure the Audio Amplifier Module with the supplied screws plus the screw removed in Step 2. It is important to secure the module with the metal screws in order to help protect against electrical transients.
6. Configure the Audio Amplifier for primary or backup amplifier operation by setting switch S1 on the amplifier:
 - (1) Position switch S1 in the DOWN position for primary operation which adds the new amplifier's 25 watts to total system power (50 watts total).
 - (2) Position switch S1 in the UP 'Backup On' position to configure the amplifier as a backup in the event the primary amplifier fails. Also for ACC-25/50ZS & ACC-25/50ZST: position switch SW1 on the ACC-ZSM board to the AAM1 position for single amplifier circuit operation.
7. Check to make certain the factory installed jumpers are in place on P1 of the Audio Amplifier Module(s). *Do not remove unless installing the FC-XRM70 Transformer Module. See Figure 3.18 on page 59 for more information.*

- Connect field wiring to newly installed amplifier. Refer to Figure 3.12 on page 52 for illustration of speaker connections if amplifier is being used to expand system power to 50 watts (i.e. providing dual 25 watt speaker circuits). Figure 5.2 on page 82 for illustration of connections if amplifier is being used as a backup.

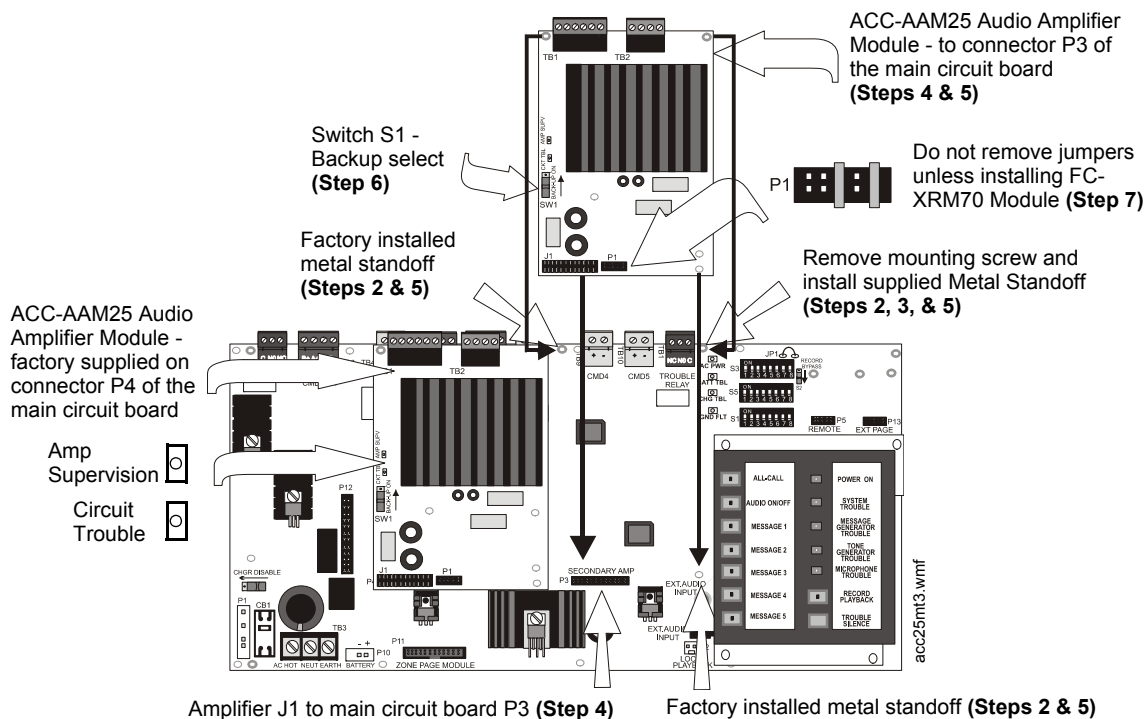

Figure 3.17 Installation of Optional Audio Amplifier

3.8.2 70.7 V_{RMS} Transformer Module (FC-XRM70)

The 70.7 V_{RMS} Transformer Module can be used to convert the 25 V_{RMS} amplifiers for installations where 70.7 V_{RMS} speakers already exist or are to be installed. Speaker wiring continues to be supervised during standby, alarm and while background music is playing when transformer is installed. Transformer connector J1 connects to amplifier connector P1.



CAUTION: DISCONNECT POWER

BEFORE INSTALLING ANY MODULES, MAKE CERTAIN ALL POWER (AC AND DC) HAS BEEN REMOVED.

- Carefully remove the ACC-AAM25 Audio Amplifier Module(s) from the main circuit board. Figure 3.17 on page 58 for installation procedures and reverse the steps.
- Install the three standoffs supplied with the FC-XRM70 Module by inserting each supplied screw into the three holes on the solder side of the ACC-AAM25 Audio Amplifier Module(s). Secure each standoff in place with the screws. Refer to Figure 3.18 for the location of the mounting holes.
- Reinstall the Audio Amplifier Module(s) following the procedure accompanying Figure 3.17.
- Remove the two factory installed jumpers from connector P1 of the Audio Amplifier Module(s). Refer to the illustration in Figure 3.18.
- Carefully align the J1 connector on the FC-XRM70 Transformer Module(s) with the P1 connector on the Audio Amplifier Module and press securely into place. Make certain the pins are properly aligned to prevent bending or breaking of pins.

- Secure the FC-XRM70 Transformer Module(s) to the Audio Amplifier Module(s) with the supplied screws.

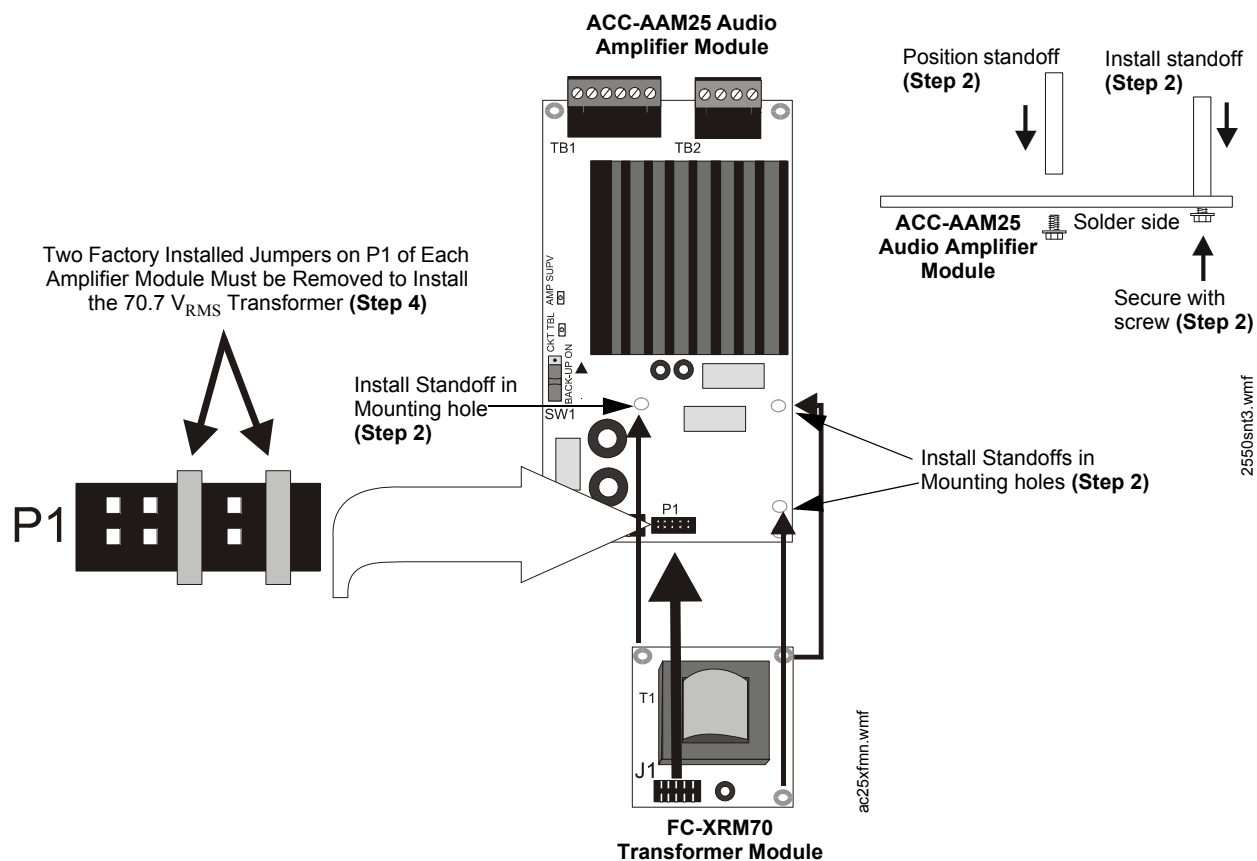

Figure 3.18 70.7 V_{RMS} Transformer Module Installation

3.8.3 Local Playback Speaker Module (FC-LPS)

The Local Playback Speaker Module can be used to monitor the recorded digital message without transmitting the message over the system speakers. The speaker module plugs into P2 of the main circuit board. This optional module is necessary to take advantage of the Playback feature.

The Speaker Module is connected by simply plugging the module connector into P2 of the main circuit board. The Speaker Module may be temporarily installed during the test period by using the supplied mounting hardware.

- Remove the main circuit board mounting screw located on the bottom center of the board. Refer to the illustration below.
- Install the supplied metal standoff in the mounting hole just vacated in Step 1 and screw standoff into place.
- Position the FC-LPS mounting bracket hole over the standoff and secure with screw removed in Step 1.
- Plug the FC-LPS Local Playback Speaker Module's polarized connector into connector P2 on the main circuit board. P2 is located on the bottom right of the main circuit board near the Control/Indicator panel.

- When testing is completed, remove the FC-LPS and standoff and reinstall the screw. The FC-LPS is not approved for permanent connection.

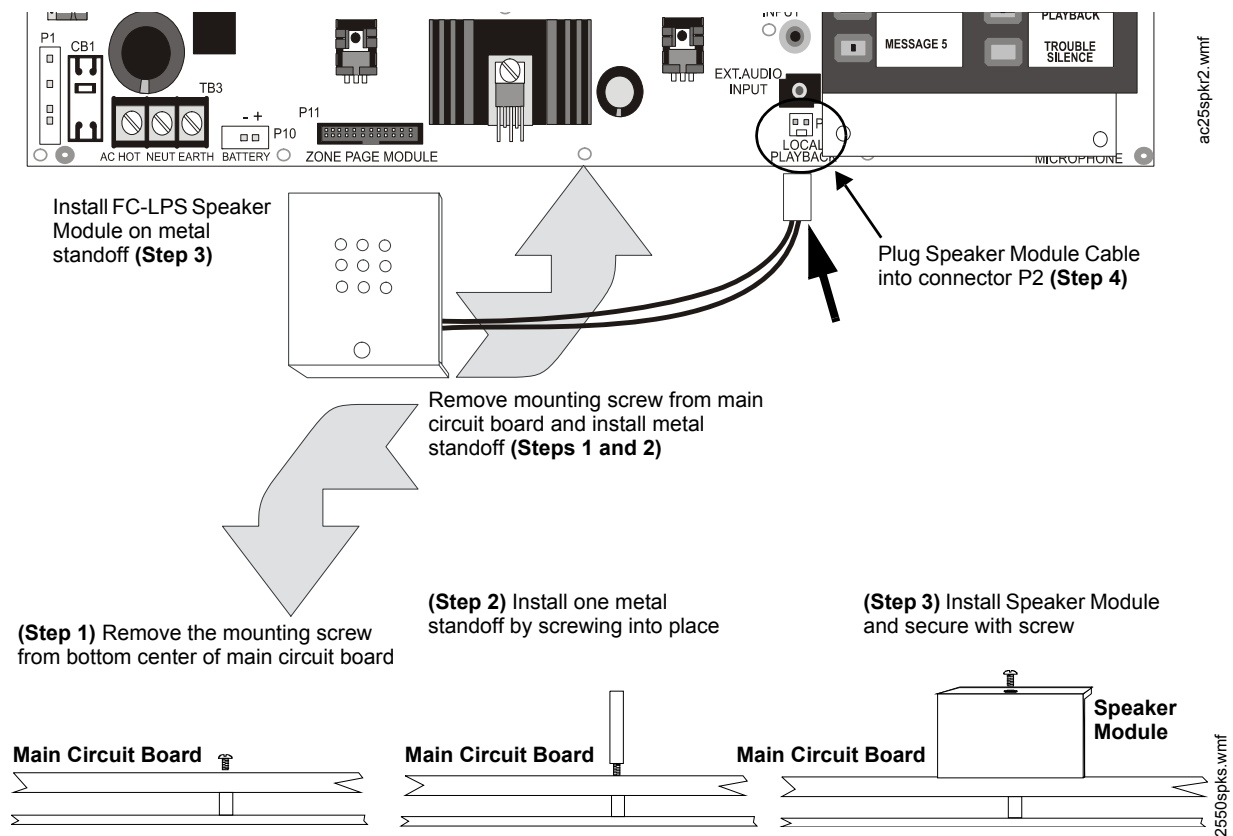

Figure 3.19 Installation of Speaker Module

3.8.4 ACC-EPM External Page Module

The ACC-EPM External Page Module can be used to interface an existing nonemergency page system with the ACC-25/50 Series panels. The connection is not supervised and the external page system will have the lowest priority which allows the ACC-25/50 Series to override all non-fire paging. Paging from non-emergency equipment is prohibited during AC loss conditions to preserve battery power.

The External Page Module is installed by plugging the module into connector P13 which is located in the top right corner of the main circuit board.



CAUTION: DISCONNECT POWER

BEFORE INSTALLING ANY MODULES, MAKE CERTAIN ALL POWER (AC AND DC) HAS BEEN REMOVED.

- Carefully align the J1 connector on the ACC-EPM module with the P13 connector on the main circuit board and press securely into place. Make certain the pins are properly aligned to prevent bending or breaking of pins.
- Secure the ACC-EPM module to the main circuit board standoff with the supplied screw.
- Wire the external paging system to Terminal TB1 on the ACC-EPM. Refer to the documentation supplied with the external paging system to ensure proper connection.

4. Test the system to ensure proper operation.

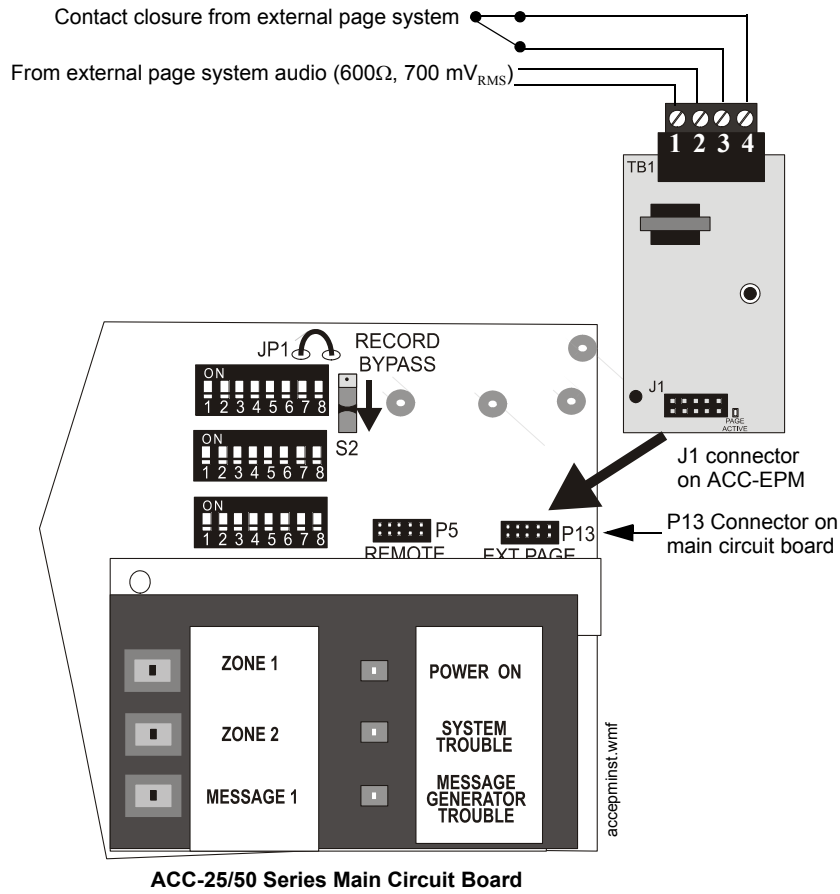

Figure 3.20 ACC-EPM External Page Module Installation

Notes

Section 4: Operating Instructions

4.1 Switch Functions

4.1.1 Single Zone Operation (ACC-25/50, ACC-25/50ZS, ACC-25/50ZST)

Figure 4.1 depicts Single Zone operation with the maximum capacity of five messages. Single Zone may be configured for two to five message control (refer to Section 2, "Field Programming" on page 32).

- ALL-CALL:
 - used to select All Call function when ACC-25/50 Series is programmed for Single Zone operation. Selecting this button also activates the Master Command Bus, which is used to trigger Distributed Audio Panels. *Single Zone operation directs the same message to all speaker circuits (S3 DIP switches 1, 2 and 3 set to one of the valid options other than all OFF)*
- AUDIO ON/OFF:
 - used to indicate that audio is on when ACC-25/50 Series is programmed for Single Zone operation (*S3 DIP switches 1, 2 and 3 set to one of the valid options other than all OFF*).
- MESSAGE 1 - used to manually transmit Message 1 over speaker circuit(s)
- MESSAGE 2 - used to manually transmit Message 2 over speaker circuit(s)
- MESSAGE 3 - used to manually transmit Message 3 over speaker circuit(s)
- MESSAGE 4 - used to manually transmit Message 4 over speaker circuit(s)
- MESSAGE 5 - used to manually transmit Message 5 over speaker circuit(s)

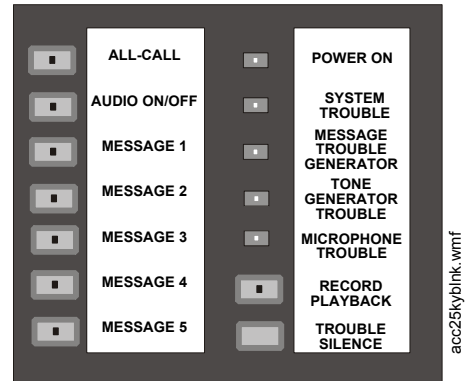

Figure 4.1 Controls and Indicators Single Zone Operation

4.1.2 Dual Zone Operation (ACC-25/50 Only)

Figure 4.2 depicts Dual Zone Operation which supports the generation of one message only (refer to Section 2, "Field Programming" on page 32).

- ZONE 1:
 - used to select Zone 1 when ACC-25/50 Series is programmed for Dual Zone operation. *Dual Zone operation directs a single message to either or both amplifier circuits (S3 DIP switches 1, 2, and 3 set to OFF)*
- ZONE 2:
 - used to select Zone 2 when ACC-25/50 Series is programmed for Dual Zone operation (*S3 DIP switches 1, 2, and 3 set to OFF*)

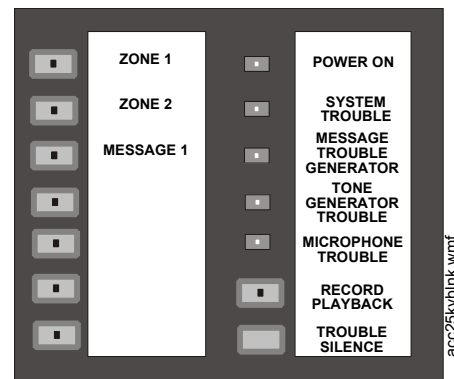

Figure 4.2 Controls and Indicators Dual Zone Operation

4.1.3 RECORD/PLAYBACK

- for recording messages when Record/Bypass switch is in the up Record position (refer to Sections “S2 - Record Bypass Switch on ACC-25/50 Series Motherboard (ACC-MCB)” on page 38, Section “S1 DIP Switch Settings on ACC-25/50 Series Motherboard (ACC-MCB)” on page 36 and Section “S5 DIP Switch Settings on ACC-25/50 Series Motherboard (ACC-MCB)” on page 37 for additional information on recording messages).
- for reviewing recorded message when Record Bypass Switch is in the down Bypass position (requires optional FC-LPS module).

4.1.4 TROUBLE SILENCE

- momentary depression silences the local piezo when system is in trouble condition.

4.1.5 Record/Playback Button - Record Customized Messages

The key labeled Record/Playback is used for recording customized messages.

Recording Instructions

Recording a custom message or messages into the ACC-25/50 Series requires that the voice message(s) be input via the internal microphone or via the RCA or mini PC Jack. After recording a new voice message, wait approximately one minute for internal supervision to take place before broadcasting the new message over the building speakers. Refer to Figure 2.1 and Figure 2.2 on page 33 for switch locations.



NOTE: For proper system operation, the voice message length must be at least 8 seconds long.

1. Confirm the Message Control settings on S3 DIP switches 1, 2, and 3. These settings will determine the number of messages that can be recorded and duration of each (refer to Table 2.7 on page 37).
2. The background music feature, which is selected by S5 DIP switch 3, must be disabled in order to record a new voice message.
3. Enable recording by setting S5 DIP switch 8 to the ON position. The Record/Playback push-button is now ready to be used in record operation.
4. Select the record input source by setting S5 DIP switch 7 to the OFF position if recording via the microphone, or to the ON position if recording via one of the External Audio Input Jacks. page 19.
5. Slide the Record Bypass switch S2 to the UP position to enable the message storage device.
6. Note the following while recording:
 - ✓ To alert the user that there is only two seconds of record time remaining, the LED on the Record/Playback push-button will change from steady-on to flashing.
 - ✓ The system Trouble LED and Trouble Relay will be on while recording but the Trouble Sounder will remain off. The system will not respond to the CMD inputs or Zone activation buttons while recording
 - ✓ It is not necessary to fill the entire record time. The time limits represent the maximum time allotted.
 - ✓ Factory default messages are replaced with the custom messages recorded from the External Audio Input jacks or internal microphone.
7. Press and release the Record/Playback push-button. This will cause the Record/Playback LED and Message push-button LEDs, as configured by S3 DIP switches 1, 2, and 3 (see Table 2.7 on page 37), to flash on and off. In addition, the panel will indicate a trouble condition since it cannot be alarm activated.

8. Press and release the push-button on the keypad (Message 1 to Message 5) associated with the voice message that will be changed. The selected Message push-button will illuminate steady and all others will extinguish.
9. The green LED on the Record/Playback push-button will continue flashing. If recording doesn't begin within 10 seconds, the record operation will be terminated.
10. Begin recording a message by using one of the following methods, depending on the setting of S5 DIP switch 7 in step 3:
 - press the microphone key switch and speak into the microphone

OR

 - press and release the selected message push-button a second time to record from either of the External Audio Input jack sources
11. The selected message push-button and Record/Playback LEDs will turn on steady during recording process
12. Upon completion of the message, to terminate recording of the current message:
 - release the microphone key switch

OR

 - press and release the selected message push-button
13. To record additional messages, repeat steps 7 through 11
14. To terminate the recording process, press and release the Record/Playback push-button. The Record/Playback LED will extinguish and the panel will return to normal.
15. Disable the record function by setting S5 DIP switch 8 to the OFF position. The Record/Playback push-button is now ready to be used for local playback.
16. Slide the Record Bypass switch S2 to the DOWN position to disable the message storage device.



CAUTION: REPLACE SWITCHES

BE CERTAIN TO SLIDE THE RECORD BYPASS SWITCH S2 TO THE DOWN POSITION WHEN RECORDING IS COMPLETED. THIS WILL PREVENT ACCIDENTAL RERECORDING OR DELETION OF THE STORED MESSAGE(S). IT IS NOT POSSIBLE TO RECORD WITH THE S2 RECORD BYPASS SWITCH IN THE DOWN POSITION. ALSO PLACE S5 DIP SWITCH 8 IN THE OFF POSITION TO ALLOW THE RECORD/PLAYBACK PUSH-BUTTON TO BE USED FOR MESSAGE PLAYBACK.

4.1.6 Record/Playback Button - Review Stored Message(s)

The Playback push-button can be used to review the stored voice message(s). By connecting the optional Local Playback Speaker Module, the message can be heard without transmitting it over the system speakers. The system must be in standby with not activity in order to begin playback operation. Refer to *Figure 2.1* and *Figure 2.2 on page 33* for switch locations.

To playback a message over the local speaker:

1. Make certain that S5 DIP switch 8 is in the OFF position to allow the Record/Playback push-button to be used for message playback.
2. Press and release the Record/Playback button.
3. Record/Playback LED will turn on steady and the Message push-button that contain messages will flash at a ½ second rate. Playback operation is terminated if step 3 does not occur within 10 seconds or if the system is alarm activated.
4. Press and release one of the flashing Message push-buttons to hear one cycle of the selected message. The selected push-button LED will illuminate steady during playback while the other Message LEDs will continue to flash.
5. Repeat step 3 to listen to any of the other stored messages.

- To end the playback function, press and release the Record/Playback push-button. The Record/Playback LED will extinguish and the Message push-button will stop flashing.

4.1.7 Main Control Panel Keypad Labels

The ACC-25/50 Series is shipped with a standard label installed in the keypad as illustrated in the following figure. A blank label is also provided to allow the user to customize the zone and message label. The installed labels can be easily removed by sliding them up through the slots in the top of the keypad. The customized labels can be installed by inserting them into the slot in the top of the keypad and sliding them down into position.

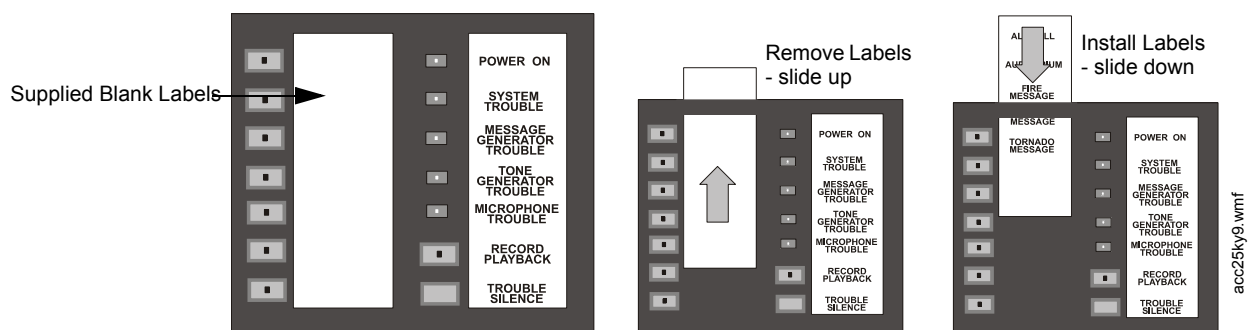

Figure 4.3 Keypad Labels

4.2 ACC-ZPMK Switch Functions (ACC-25/50ZS & ACC-25/50ZST)

The ACC-ZPMK Zone Page Module consists of 24 tactile push-button keys. Pressing one or more of the keys while the panel is not in alarm will select the corresponding circuit for paging or to generate a manually activated evacuation or drill signal. If the panel is in alarm, pressing a key corresponding to an activated speaker circuit will turn off the circuit and turn on the Trouble LED.

- If the ACC-ZPMK and ACC-ZSM are configured for Class A (Style Z) speaker circuit wiring, the first four switches are used to control the four Class A speaker circuits wired to the ACC-ZSM which is installed in the ACC-25/50ZS & ACC-25/50ZST audio panel.
- If the ACC-ZPMK and ACC-ZSM are configured for Class B (Style Y) speaker circuit wiring, the first eight switches are used to control the eight Class B speaker circuits wired to the ACC-ZSM which is installed in the ACC-25/5ZS & ACC-25/50ZST audio panel.
- The remaining switches correspond to speaker circuits on ACC-25/50DA panels.

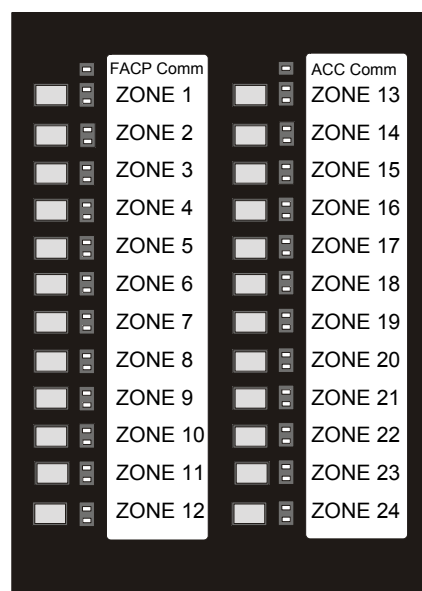

Figure 4.4 ACC-ZPMK Keypad/Annunciator

Labels

The ACC-ZPMK keypad labels are installed in a similar fashion as the main control panel keypad labels. Refer to Section “Main Control Panel Keypad Labels” on page 66.

4.3 ACC-FFT Answer Call Push-Button (ACC-25/50ZST)

When a Fire Fighter inserts the FFT Handset (FHS-F) into a remote FFT jack (FPJ-F or RPJ-F), the Answer Call LED will flash and the piezo will beep. Pressing the Answer Call push-button in this mode will connect the local FFT Handset with the remote FHS-F. Conversations between the two locations can be performed by pressing the Push-to-Talk switch on each FFT Handset. To terminate the conversation, unplug the remote FFT Handset (FHS-F) and press the Answer Call push-button again. Figure 3.15, “ACC-FFT Fire Fighter Telephone Module” on page 55, for additional information.

4.4 LED Indicators

4.4.1 LEDs Visible with Backbox Door Closed (Figure 4.1 on page 63)

Power On

A green LED that remains on while power is within correct limits. *If this indicator fails to light under normal conditions, check for AC and battery power and service the system immediately.*

System Trouble

This yellow LED turns on steady to indicate that a fault or abnormal condition exists and that the ACC-25/50 may be inoperative. *Do not allow trouble conditions to remain on the system. Service the system immediately.*

Message Generator Trouble

This yellow LED turns on steady when the supervised digital message generator fails or falls below acceptable levels.

Tone Generator Trouble

This yellow LED turns on steady when one of the supervised tone generators fail or fall below acceptable levels.

Microphone Trouble

This yellow LED turns on steady when the supervised microphone connection is open.

Record/Playback

This green LED turns on steady, when the Record/Playback push-button is pressed, to indicate that the recording process is ready to begin. The LED remains on during recording and turns off when the Record/Playback push-button is pressed to terminate the recording process

Zone 1/All-Call

- Dual Zone Operation - this two color LED turns green when Zone 1 speaker circuit is activated by an alarm condition or manually and turns yellow when the push-button is pressed during an alarm condition to turn off the Zone 1 speaker circuit
- Single Zone Operation - this LED turns green when the push-button is pressed to initiate an All-Call operation

Zone 2/Audio On/Off

- Dual Zone Operation - this two color LED turns green when Zone 2 speaker circuit is activated by an alarm condition or manually and turns yellow when the push-button is pressed during an alarm condition to turn off the Zone 2 speaker circuit
- Single Zone Operation - this two color LED turns green to indicate that audio has been activated by an alarm condition or manually and turns yellow when the push-button is pressed during an alarm condition to turn off the audio

Message 1

This green LED turns on steady to indicate that Message 1 has been activated by an alarm or manually. *Note that during the recording process, when the push-button is pressed, the LED will flash at a ½ second rate to indicate that Message 1 is ready to be recorded. When recording begins, the LED will turn on steady.*

Message 2

This green LED turns on steady to indicate that Message 2 has been activated by an alarm or manually. *Note that during the recording process, when the push-button is pressed, the LED will flash at a ½ second rate to indicate that Message 2 is ready to be recorded. When recording begins, the LED will turn on steady.*

Message 3

This green LED turns on steady to indicate that Message 3 has been activated by an alarm or manually. *Note that during the recording process, when the push-button is pressed, the LED will flash at a ½ second rate to indicate that Message 3 is ready to be recorded. When recording begins, the LED will turn on steady.*

Message 4

This green LED turns on steady to indicate that Message 4 has been activated by an alarm or manually. *Note that during the recording process, when the push-button is pressed, the LED will flash at a ½ second rate to indicate that Message 4 is ready to be recorded. When recording begins, the LED will turn on steady.*

Message 5

This green LED turns on steady to indicate that Message 5 has been activated by an alarm or manually. *Note that during the recording process, when the push-button is pressed, the LED will flash at a ½ second rate to indicate that Message 5 is ready to be recorded. When recording begins, the LED will turn on steady.*

4.4.2 ACC-ZMPK LEDs Visible with Backbox Door Closed (Figure 4.4 on page 66)

FACP Communication

A green LED that remains on when an FACP is connected to the ACC-25/50ZS & ACC-25/50ZST via the ACS (EIA-485) link from TB1 of the ACC-ZPMK to the ACS terminal on the FACP. If the LED fails to light, an FACP is not connected or the ACS wiring is faulty. The LED is located in the top left of the keypad (refer to Figure 4.4 on page 66 for location).

ACC Communication

A green LED that remains on when the ACC-ZPMK is properly communicating with the ACC-25/50ZS & ACC-25/50ZST main circuit board via the connecting cable. If the LED fails to light, communication has been lost between the ACC-ZPMK and audio panel. The LED is located in the top right of the keypad (refer to Figure 4.4 on page 66 for location).

Zone/Circuit Active

A green LED corresponding to each of the 24 circuits on the ACC-ZPMK Zone Page Module. The LED turns on when the circuit is manually activated by pressing the corresponding key or during an alarm condition under FACP program control. Pressing the key while the circuit is active will turn off the circuit and its corresponding LED.

Zone/Circuit Trouble

A yellow LED corresponding to each of the 24 circuits on the ACC-ZPMK Zone Page Module. The LED turns on when the circuit, which has been activated under program control during an alarm, is turned off by pressing the corresponding key. The LED will also turn on if a short or open is detected on the speaker circuit.

4.4.3 ACC-FFT LEDs Visible with Backbox Door Closed (Figure 3.15 on page 55)**Power**

A green LED that remains on while DC power is within correct limits.

Answer Call

This green LED flashes at a ½ second rate to indicate that a Fire Fighter Telephone handset (FHS-F) has been plugged into a remote jack (FPJ-F or RPJ-F). The LED turns on steady when the corresponding pushbutton is pressed in response to the remote FFT jack activation.

Remote Handset Page

This green LED turns on steady when the Keyswitch on the RPJ-F is activated.

Remote Microphone Page

This green LED turns on steady when the Remote Microphone push-to-talk switch is activated.

Remote Handset Trouble

This yellow LED turns on steady when a fault occurs on the telephone audio circuit.

Local Handset Trouble

This yellow LED turns on steady when the supervised local handset connection is open.

Remote Key Trouble

This yellow LED turns on steady when a fault occurs in the Remote Keyswitch circuit.

Remote Fire Fighter Telephone Status

This green LED turns on steady when a Fire Fighter Telephone handset (FHS-F) is plugged into an FPJ-F or RPJ-F (requires ACS hookup to addressable FACP using monitor modules).

Remote Microphone Trouble

This yellow LED turns on steady to indicate that a fault exists on the Remote Microphone electronics or wiring.

4.4.4 LEDs Visible with Door Open and Optional Dress Panel Removed (Figure 1.1 & Figure 1.2)**AC Power (main circuit board)**

A green LED that remains on while AC power is within correct limits. *If this indicator fails to light under normal conditions, check for AC power and service the system immediately!*

Battery Trouble (main circuit board)

This yellow LED turns on steady when the battery is disconnected or battery voltage drops below an acceptable level.

Charger Trouble (main circuit board)

This yellow LED turns on steady when the battery charger voltage falls below an acceptable level.

Ground Fault (main circuit board)

This yellow LED turns on steady when a ground fault condition (zero impedance to ground) is detected on the system.

Amp Supv - Supervision (Audio Amplifier Module)

This green LED (one on each amplifier), when on steady, indicates that the amplifier is fully functional. The ACC-25/50 Series panels constantly test the amplifier to verify proper operation.

Circuit Trouble (Audio Amplifier Module)

This yellow LED (one on each amplifier) turns on steady when a trouble is detected in the amplifier or to indicate an open or short circuit on the field wiring attached to the amplifier output terminals.

Remote Microphone Trouble (Optional FC-MIM Microphone Interface Module)

This yellow LED turns on steady when a remote microphone trouble is detected from the FC-RM or wiring

4.5 Operation

The ACC-25/50 Series continuously monitors system status. When no system alarm or local trouble conditions exist, all LEDs are off except the Power On LED located on the front panel keypad, the amplifier supervision LED(s) and the AC Power LED located on the main circuit board. The Notification Appliance Circuits (speakers) are off and all relays are in their normal state. Zone activations and local troubles are annunciated by the ACC-25/50's LEDs.

4.5.1 Fire Alarm

The ACC-25/50 Series will, upon detection of an alarm condition (CMD1, CMD2, CMD3, CMD4 or CMD5 Inputs active or via the ACS):

- ✓ Turn on the appropriate Zone LED steady
- ✓ Turn on the appropriate Notification Appliance Circuit speakers (depending on CMD input source)
- ✓ Turn on the appropriate Audio Amplifier(s)
- ✓ Transmit the tone before message if programmed (repeating tone number of times programmed)
- ✓ Transmit the appropriate digital voice message (repeating message number of times programmed)
- ✓ Transmit the tone after message if programmed (repeating tone number of times programmed)
- ✓ Transmit a primary evacuation tone only (if programmed)

4.5.2 Fire Alarm Restoral

- ✓ Turn off the Zone LED located on the front panel
- ✓ Turn off the Notification Appliance Circuits
- ✓ Turn off the Audio Amplifiers
- ✓ Turn off the digital voice message or tone at its present point in transmission

4.5.3 Manual Evacuation/Alert

Dual Zone Operation

The ACC-25/50 Series will, upon pressing of the Zone 1 and/or Zone 2 push-button (if programmed to do so) followed by the Message 1 push-button:

- ✓ Turn on the appropriate Zone and Message 1 LED steady
- ✓ Turn on selected Notification Appliance Circuit speaker(s)
- ✓ Turn on selected Audio Amplifier(s)
- ✓ Transmit the tone before message if programmed
- ✓ Transmit the appropriate digital voice message (repeating message the number of times programmed)
- ✓ Transmit the tone after message if programmed (repeating tone the number of times programmed)
- ✓ Transmit a primary evacuation tone only (if programmed)

Single Zone Operation

Manual Evacuation for Single Zone Operation is the same as Dual Zone except it is not necessary to press the Zone1/Zone 2 push-button(s).

4.5.4 Manual Evacuation/Alert Restoral

Dual Zone Operation (ACC-25/50 Only)

The ACC-25/50 Series will, upon pressing of the Zone 1 and/or Zone 2 push-button and the selected message push-button a second time:

- ✓ Turn off the appropriate Zone and Message LED
- ✓ Turn off selected Notification Appliance Circuit speakers
- ✓ Turn off selected Audio Amplifiers
- ✓ Turn off the digital voice message or tone at its present point in transmission

Single Zone Operation

Manual Evacuation Restoral for Single Zone Operation is the same as Dual Zone except it is not necessary to press the Zone1/Zone 2 push-button(s).

4.5.5 Audio On/Off: ACC-25/50 Single Zone and ACC-25/50ZS/T

When the ACC-25/50 is programmed for Single Zone operation, the Zone 2 push-button is configured for Audio On/Off indication and control. The LED in the Audio On/Off push-button will illuminate green when the ACC-25/50 Series has been activated manually (microphone, message button, etc.) or automatically by an FACP.

Pressing the Audio On/Off button while the system is active (LED=green) will disconnect audio to the output of the Audio Amplifier Module(s) and:

- illuminate the Audio On/Off push-button LED yellow and generate a system trouble to indicate manual deactivation if the ACC-25/50 Series was activated by an FACP

OR

- extinguish the Audio On/Off LED if the system was manually activated (*no system trouble is generated*)

Pressing this button when the system is deactivated will restore audio back to the Audio Amplifier Module output(s) and cause the Audio On/Off LED to illuminate green.

4.5.6 All Call: ACC-25/50, Single Zone Configuration

When the ACC-25/50 is configured for Single Zone operation, All-Call functionality is assigned to the Zone 1 Push-button. All-Call activates **all non-manually deactivated** speaker circuits. Pressing the All-Call push-button activates the ACC-25/50 speaker circuit(s) and energizes the Master Command Bus to trigger the speaker circuits on all ACC-25/50DA(s). *Note that All-Call paging*

from the local/integral microphone will override paging operations from the optional Remote Microphone. Refer to Section “S3 DIP Switch Settings on ACC-25/50 Motherboard (ACC-MCB)” on page 37 and the ACC-25/50DA Manual, Document #52265, for additional information.

All-Call General Page Using Local Microphone

Selecting the All-Call push-button and pressing the local microphone push-to-talk switch will direct paging audio to all speaker circuits.

All-Call General Page Using Optional Remote Microphone

Pressing the remote microphone push-to-talk switch will direct paging audio to all speaker circuits, and illuminate the All-Call and Audio On/Off buttons on the keypad. *Note that Remote Microphone All-Call functionality is DIP switch programmable for the ACC-25/50. Set the DIP switch to ON. Refer to Section “S3 DIP Switch Settings on ACC-25/50 Motherboard (ACC-MCB)” on page 37.*

All-Call Emergency Page Using Local Microphone

Selecting the All-Call push-button and pressing the local microphone push-to-talk switch will interrupt the tone/voice message and direct paging audio to all speaker circuits. The system will revert back to the tone/voice message if the microphone key is held for more than 3 minutes.

All-Call Emergency Page Using Optional Remote Microphone

Pressing the remote microphone push-to-talk switch will interrupt the tone/voice message and direct paging audio to all speaker circuits, and illuminate the All-Call and Audio On/Off buttons on the keypad. The system will revert back to the tone/voice message if the remote microphone key is held for more than 3 minutes. *Note that Remote Microphone All-Call functionality is DIP switch programmable for the ACC-25/50. Set the DIP switch to ON. Refer to Section “S3 DIP Switch Settings on ACC-25/50 Motherboard (ACC-MCB)” on page 37.*

All-Call During FACP Activated Alarm

Selecting the All-Call push-button will direct the FACP activated tone/voice message audio to all speaker circuits.

All-Call During Manual Evacuation/Alert

Selecting the All-Call push-button and pressing one of the Message push-buttons will direct the tone/voice message audio to all speaker circuits.

All-Call With Distributed Audio Panels

Selecting the All-Call pushbutton activates the Master Command Bus (ACC-25/50 ONLY), which triggers all Distributed Audio Panels. All-Call Paging or Messaging is generated over all speaker circuits.

4.5.7 All-Call: ACC-25/50ZS & ACC-25/50ZST

The ACC-25/50ZS & ACC-25/50ZST uses the Zone Page Module (ACC-ZPM) for control of audio zones. Pressing the All-Call push-button will activate **all non manually deactivated** speaker circuits on the Zone Page Module, activate the Audio Amplifier Module (ACC-AAM25) output(s). *The S3 DIP switches on the ACC-25/50ZS & ACC-25/50ZST motherboard must be set for single zone operation. Note the All-Call paging from the local/integral microphone will override paging from the RPJ-F and Remote Microphone. Paging from the RPJ-F will override paging operations from the Remote Microphone. Refer to Section “S3 DIP Switch Settings on ACC-25/50 Motherboard (ACC-MCB)” on page 37.*

All-Call General Page Using Local/Integral Microphone

Selecting the All-Call push-button and pressing the local microphone push-to-talk switch will direct paging audio to all Zone Page Module speaker circuits.

All-Call General Page Using Optional Remote Microphone

Pressing the remote microphone push-to-talk switch will direct paging audio to all Zone Page Module speaker circuits, and illuminate the All-Call and Audio On/Off buttons on the keypad. *Note that Remote Microphone All-Call functionality is standard for the ACC-25/50ZS & ACC-25/50ZST. Refer to Section “S3 DIP Switch Settings on ACC-25/50 Motherboard (ACC-MCB)” on page 37.*

All-Call General Page Using Optional RPJ-F Remote Keyswitch via the Optional Fire Fighter Telephone Module:

Engaging the keyswitch on the remote RPJ-F will direct paging audio to all Zone Page Module speaker circuits. *This is available with the ACC-25/50ZST only.*

All-Call Emergency Page Using Local/Integral Microphone

Selecting the All-Call push-button and pressing the local microphone push-to-talk switch will interrupt the tone/voice message and direct paging audio to all Zone Page Module speaker circuits. The system will revert back to the tone/voice message if the microphone key is held for more than 3 minutes.

All-Call Emergency Page Using Optional Remote Microphone

Pressing the remote microphone push-to-talk switch will interrupt the tone/voice message, direct paging audio to all Zone Page Module speaker circuits and illuminate the All-Call and Audio On/Off buttons on the keypad. The system will revert back to the tone/voice message if the remote microphone key is held for more than 3 minutes. *Note that Remote Microphone All-Call functionality is standard for the ACC-25/50ZS & ACC-25/50ZST. Refer to Section “S3 DIP Switch Settings on ACC-25/50 Motherboard (ACC-MCB)” on page 37.*

All-Call Emergency Page Using Optional RPJ-F Remote Keyswitch via the Fire Fighter Telephone Module

Engaging the keyswitch on the remote RPJ-F will interrupt the tone/voice message and direct paging audio to all non-manually deactivated Zone Page Module speaker circuits. *This is available with the ACC-25/50ZST only.*

All-Call During FACP Activated Alarm

Selecting the All-Call push-button will direct the FACP activated tone/voice message audio to all Zone Page Module speaker circuits.

All-Call During Manual Evacuation/Alert

Selecting the All-Call push-button and pressing one of the Message push-buttons will direct the tone/voice message audio to all Zone Page Module speaker circuits.

4.5.8 Paging: ACC-25/50 Single Zone

Refer also to Section “All Call: ACC-25/50, Single Zone Configuration” on page 71 for All-Call type paging operation. *Note that paging from the local/integral microphone will override paging operations from the Remote Microphone.*

General Page Using Local/Integral Microphone

Pressing the local microphone push-to-talk switch will direct paging audio to the Audio Amplifier Module (ACC-AAM25) speaker circuit(s).

General Page Using Optional Remote Microphone

Pressing the remote microphone push-to-talk switch will direct paging audio to the Audio Amplifier Module (ACC-AAM25) speaker circuit(s). *Note that Remote Microphone All-Call functionality is DIP switch programmable for the ACC-25/50. Set the DIP switch to OFF if only activating ACC-25/50 speaker circuits is desired. Refer to Section “S3 DIP Switch Settings on ACC-25/50 Motherboard (ACC-MCB)” on page 37.*

Emergency Page Using Local/Integral Microphone

Pressing the local microphone push-to-talk switch will interrupt the tone/voice message and direct paging audio to the Audio Amplifier Module (ACC-AAM25) speaker circuit(s). The system will revert back to the tone/voice message if the microphone key is held for more than 3 minutes.

Emergency Page Using Optional Remote Microphone

Pressing the remote microphone push-to-talk switch will interrupt the tone/voice message and direct paging audio to the Audio Amplifier Module (ACC-AAM25) speaker circuit(s). The system will revert back to the tone/voice message if the remote microphone key is held for more than 3 minutes. *Note that Remote Microphone All-Call functionality is DIP switch programmable for the ACC-25/50. Set the DIP switch to OFF if only activating ACC-25/50 speaker circuits is desired. Refer to Section “S3 DIP Switch Settings on ACC-25/50 Motherboard (ACC-MCB)” on page 37.*

4.5.9 Paging: ACC-25/50 Dual Zone

When the ACC-25/50 is configured for Dual Zone operation, the speaker circuits connected to each Audio Amplifier Module (ACC-AAM25) are controlled individually by the Zone 1 and Zone 2 push-buttons. Paging is performed on a *select by zone* basis. *Note that paging from the local/integral microphone will override paging operations from the optional Remote Microphone.*

General Page Using Local/Integral Microphone

Selecting the Zone 1 and/or Zone 2 push-buttons(s) and pressing the local microphone push-to-talk switch will direct paging audio to the speaker zone(s).

General Page Using Optional Remote Microphone

Pressing the remote microphone push-to-talk switch will direct paging audio to the Audio Amplifier Module (ACC-AAM25) speaker zone(s). *Note that Remote Microphone All-Call functionality is DIP switch programmable for the ACC-25/50. Set the DIP switch to OFF for Dual Zone configuration. Refer to Section “S3 DIP Switch Settings on ACC-25/50 Motherboard (ACC-MCB)” on page 37.*

Emergency Page Using Local/Integral Microphone

Pressing the local microphone push-to-talk switch during an FACP activated alarm will interrupt the tone/voice message and direct paging audio to non manually deactivated speaker zones. Emergency paging to non-FACP activated speaker zones may be performed by selecting the speaker zones (Zone 1 and/or Zone2) and pressing the microphone push-to-talk switch. The system will revert back to the tone/voice message if the microphone key is held for more than 3 minutes.

Emergency Page Using Optional Remote Microphone

Pressing the remote microphone push-to-talk switch during an FACP activated alarm will interrupt the tone/voice message and direct paging audio to non manually deactivated speaker zones. The system will revert back to the tone/voice message if the remote microphone key is held for more than 3 minutes. *Note that Remote Microphone All-Call functionality is DIP switch programmable for the ACC-25/50. Set the DIP switch to OFF for Dual Zone configuration. Refer to Section “S3 DIP Switch Settings on ACC-25/50 Motherboard (ACC-MCB)” on page 37.*

4.5.10 Paging: ACC-25/50ZS & ACC-25/50ZST

Refer also to Section “All-Call: ACC-25/50ZS & ACC-25/50ZST” on page 72 for All-Call type paging operation. In this system configuration, the Zone Page Module (ACC-ZPM) permits paging by zone.

General Page Using Local/Integral Microphone

Selecting any of the Zone push-buttons(s) on the Zone Page Module (ACC-ZPM) and pressing the local microphone push-to-talk switch will direct paging audio to the speaker circuit(s).

General Page Using Optional Remote Microphone

Pressing the remote microphone push-to-talk switch will direct paging audio to all speaker circuits on the Zone Page Module. Refer to Section “All-Call General Page Using Optional Remote Microphone” on page 73 for additional information.

General Page Using the Optional RPJ-F Remote Keyswitch via the Optional Fire Fighter Telephone Module

Engaging the keyswitch on the remote RPJ-F will direct paging audio to all Zone Page Module speaker circuits. *This is available with the ACC-25/50ZST only.*

Emergency Page Using Local/Integral Microphone

Pressing the local microphone push-to-talk switch during an FACP activated alarm will interrupt the tone/voice message and direct paging audio to non manually deactivated speaker circuits on the Zone Page Module (ACC-ZPM). Emergency paging to non-FACP activated speaker circuits may be performed by selecting the zone push-button and pressing the microphone push-to-talk switch. The system will revert back to the tone/voice message if the microphone key is held for more than 3 minutes.

Emergency Page Using Optional Remote Microphone

Pressing the remote microphone push-to-talk switch during an FACP activated alarm will interrupt the tone/voice message and direct paging audio to non manually deactivated speaker circuits. The system will revert back to the tone/voice message if the remote microphone key is held for more than 3 minutes. *Refer to Section “All-Call General Page Using Optional Remote Microphone” on page 73 for additional information.*

Emergency Page Using Optional RPJ-F Remote Keyswitch via the Optional Fire Fighter Telephone Module

Engaging the keyswitch on the remote RPJ-F will interrupt the tone/voice message and direct paging audio to all non-manually deactivated Zone Page Module speaker circuits. *This is available with the ACC-25/50ZST only.*

4.5.11 Fire Fighter Telephone: ACC-25/50ZST Only

The ACC-25/50ZST provides a telephone interface for up to 24 remote FFT jack locations and permits up to six (local phone handset plus five FHS-F remote phone handsets) simultaneous connections. Two available styles of remote FFT jacks are the FPJ-F and the RPJ-F, both providing a standard audio plug interface for the FHS-F handsets. The RPJ-F also houses a keyswitch for remote paging operations. *S3 switch 7 on the ACC-25/50ZST motherboard (ACC-MCB) must be set to **ON**.*

Communication on the Telephone Loop

When a Fire Fighter plugs the handset into one of the remote FFT locations, a ring-back tone will be heard at the remote location, the Answer Call LED will flash and the piezo will sound on the ACC-FFT module located in the ACC-25/50ZST main panel. The user at the main panel can answer the remote call by picking up the local handset and pressing the Answer Call pushbutton, which turns the Answer Call LED on steady and terminates the ringback tone. Both parties can now converse by depressing the respective push-to-talk switch on the handsets.

Additional handsets (up to 4 more) can plug-in and converse in a party-line format. Proper termination of communication requires that all remote jacks be unplugged and that the Answer Call pushbutton be pressed. If this procedure is not followed, a system fault condition will occur.

Annunciation of Remote Telephone Locations (MS-9600 or MS-9200UDLS only)

In addition to the operation described in Section , "Communication on the Telephone Loop", one of the 24 corresponding FFT LEDs on the ACC-FFT keypad will illuminate to indicate which remote FFT location in the building has the handset installed.

4.5.12 Trouble Condition Response

All trouble conditions are fully supervised in standby and alarm unless otherwise noted and will cause the following to occur (note that response to AC loss will depend on the setting of S3 switch 8 as shown in Table 2.3 on page 34):

- ✓ Deenergize the trouble relay causing the contacts to transfer
- ✓ Turn on local piezo
- ✓ Turn on the system Trouble LED
- ✓ Open CMD1 input - ONLY if CMD1 is not in the alarm state

In addition to the above trouble responses, the following troubles will cause the specific responses noted:

AC Loss

- Turn off the AC PWR LED on the main circuit board
- Deenergize AC Loss Relay on the main circuit board (immediate, 2 hour or 6 hour delay depending on S3 DIP switch 4 & 5 position)
- Deenergize Form-C Trouble and CMD1 contacts if S3 switch 8 is OFF (refer to Table 2.3 on page 34)

Battery Trouble (low or no battery)

- Turn on the Battery Trouble LED on the main circuit board

Charger Trouble

- Turn on the Charger Trouble LED on the main circuit board

Ground Fault

- Turn on the Ground Fault LED on the main circuit board when zero impedance to ground is detected

Microphone Fault

- Turn on the Microphone Trouble LED on the keypad

Tone Generator Fault

- Turn on the Tone Generator Trouble LED on the keypad

Message Generator Trouble

- Turn on the Message Generator Trouble LED on the keypad

CMD1 or CMD2 (Indicated by the System Trouble LED)

- Both inputs are supervised for open circuit condition when unit is programmed for Normally Open contacts, otherwise supervision is provided by the host Fire Alarm Control Panel NAC output

CMD3, CMD4, and CMD5 (Indicated by the System Trouble LED)

- All inputs are supervised for open circuit condition

Master Command (Indicated by the System Trouble LED)

- Polarity reversal circuit supervised for open and short circuits while in standby only.

Background Music

- When background music option is enabled via S5 DIP switch 3, the ACC-25/50 will constantly monitor the external audio input RCA Jack. Both amplifiers and speaker wiring continue to be fully supervised when background* music is output from the ACC-25/50. Amplifier faults are reported after 75 seconds. Note that when AC power is lost, the ACC-25/50 will shut off background music to conserve batteries.

**Note that the Local Authority Having Jurisdiction must approve the use of background music.*

**Background music is not available with the ACC-25/50ZS or ACC-25/50ZST*

Amplifier Fault

- Both amplifiers are constantly monitored for proper functionality. Should either amplifier fail, the AMP SUPV LED will turn off and the Circuit Trouble LED will turn on. When the system is configured for backup, failure of the primary amplifier will cause the backup amplifier to be switched in.

NAC (Speaker) Output

- The wiring to each amplifier is supervised for opens and shorts at all times in standby and while in alarm or when background music* is enabled. A wiring fault will cause the circuit Trouble LED located on each amplifier module to turn on. It should be noted that the green AMP SUPV LED may remain on for wiring faults.
- The ACC-ZSM wiring to each speaker circuit is supervised for opens and shorts in standby and for shorts while in alarm. A wiring fault will cause the zone/circuit Trouble LED on the ACC-ZPMK corresponding to the affected circuit to turn on.

**Note that the Local Authority Having Jurisdiction must approve the use of background music.*

**Background music is not available with the ACC-25/50ZS or ACC-25/50ZST*

ACC-ZPMK Zone Page Module

- The ACS wiring between the ACC-ZPMK and FACP is supervised. A loss of communication on the ACS (EIA-485) link will cause the FACP Trouble LED to light on the ACC-ZPMK module.
- The ribbon cable between the ACC-ZPMK and audio panel is supervised. A loss of communication will cause the ACC Trouble LED to light on the ACC-ZPMK module.

Remote Microphone

- The FC-RM Remote Microphone and associated wiring are supervised for faults by the panel.
- ACC-25/50 & ACC-25/50ZS: The Trouble LED located on the FC-MIM Microphone Interface Module, which is mounted in the panel, will illuminate on a trouble condition.
- ACC-25/50ZST: The Remote Microphone Trouble LED located on the ACC-FFT keypad will illuminate on a trouble condition. Refer to the *FC-RM Product Installation Document #51247* for a description of possible fault conditions

Power ON LED

- The loss of primary (AC) and secondary (battery) power will extinguish the Power ON LED.

Internal Power Supplies

- Power fed to the amplifiers from the main circuit board is fully supervised. Should standby or alarm power feeds to either amplifier fail, the unit will go into trouble. *Note that a power trouble on one amplifier will not affect the power to the other amplifier.*

4.5.13 Trouble Condition Restoral

All trouble condition restorals will cause the following to occur (note that response to AC loss restoral will depend on the setting of S3 switch 8 as shown in Table 2.3 on page 34):

- ✓ Reenergize the trouble relay returning contacts to normal position
- ✓ Turn off local piezo
- ✓ Turn off the system Trouble LED
- ✓ Close CMD1 input

In addition to the previous trouble condition restorals, the following specific restorals will occur:

AC restoral

- Turn on the AC PWR LED on the main circuit board
- Reenergize the AC Loss Relay on the main circuit board returning contacts to normal position
- Reenergize Form-C Trouble and CMD1 contacts if S3 switch 8 is OFF (refer to Table 2.3 on page 34)

Battery restoral

- Turn off the Battery Trouble LED on the main circuit board

Ground Fault cleared

- Turn off the Ground Fault LED on the main circuit board

Microphone restoral

- Turn off the Microphone Trouble LED on the front panel keypad

Tone Generator restoral

- Turn off the Tone Generator Trouble LED on the front panel keypad

Message Generator restoral

- Turn off the Message Generator Trouble LED on the front panel keypad

Amplifier restoral

- The AMP SUPV LED will turn on and the Circuit Trouble LED will turn off. When the system is configured for backup, restoral of the primary amplifier will cause the backup amplifier to be switched out

NAC (Speaker) Output restoral

- The wiring to each amplifier is supervised for opens and shorts at all times in standby and while in alarm or when background music* is enabled. A restoral of a wiring fault will cause the circuit Trouble LED located on each amplifier module to turn off. It should be noted that the green AMP SUPV LED is on
- The ACC-ZSM wiring to each speaker circuit is supervised for opens and shorts in standby and for shorts while in alarm. Restoral of a wiring fault will cause the zone/circuit Trouble LED on the ACC-ZPMK corresponding to the affected circuit to turn off.

**Note that the Local Authority Having Jurisdiction must approve the use of background music.*

**Background music is not available with the ACC-25/50ZS or ACC-25/50ZST*

ACC-ZPMK Zone Page Module restoral

- The ACS wiring between the ACC-ZPMK and FACP is supervised. Restoral of communication on the ACS (EIA-485) link will cause the FACP Trouble LED to turn off on the ACC-ZPMK module.
- The ribbon cable between the ACC-ZPMK and audio panel is supervised. Restoral of communication will cause the ACC Trouble LED to turn off on the ACC-ZPMK module.

Remote Microphone restoral

- Turn off the Remote Microphone Trouble LED located on the FC-MIM module for the ACC-25/50 or ACC-25/50ZS
- Turn off the Remote Key/Microphone Trouble LED located on the ACC-25/50ZST ACC-FFT module

Power ON LED - power restoral

- A restoral of AC power at TB3 will turn on the Power On LED

Internal Power Supplies restoral

- Power fed to the amplifiers from the main circuit board is fully supervised. Restoral of standby or alarm power feeds to either amplifier will cause the unit to clear the trouble indications

Section 5: Application Examples

The AUDIO•COMMAND•CENTER•25/50, AUDIO•COMMAND•CENTER•25/50ZS, and AUDIO•COMMAND•CENTER•25/50ZST are voice evacuation control panels which can be used, with a variety of Fire Alarm Control Panels, to provide emergency audio messages. This chapter contains a few application examples and is not meant to provide a comprehensive list of all possible ACC-25/50 Series applications.

5.1 One Speaker Circuit on ACC-25/50

Single Output Zone (Table 2.7 on page 37 for Message Control switch settings)

A very basic application consists of one ACC-25/50 Series with one amplifier and a single speaker circuit. This configuration is suitable for small facilities requiring no more than 25 watts of output power. A single fire evacuation message will be generated during an alarm condition from the host FACP or manually by a message push-button.

In this application, the NAC from the host FACP is connected to CMD1. The CMD1 out terminals are then terminated with an EOL resistor for the FACP's Style Y NAC or the terminals are wired back to the host FACP for a Style Z NAC. S3 DIP switches 1, 2 and 3 are set to OFF which causes a 60 second message to be sent to the speaker circuit when CMD1 input is activated. S5 DIP switch 5 is set to OFF which causes CMD1 input to be activated by a reverse polarity condition. CMD3, CMD4, and CMD5 inputs require End-of-Line resistors and CMD2 cannot be used to trigger the ACC-25/50.

IMPORTANT! When CMD1 is configured for reverse polarity, the NAC cannot be Coded.

In this application, the system may also be manually activated via the keypad by selecting the *Building Speakers* zone push-button followed by the selection of the *Fire Message* push-button, or by using the microphone to make an announcement. Refer to the Keypad example in Figure 5.1.

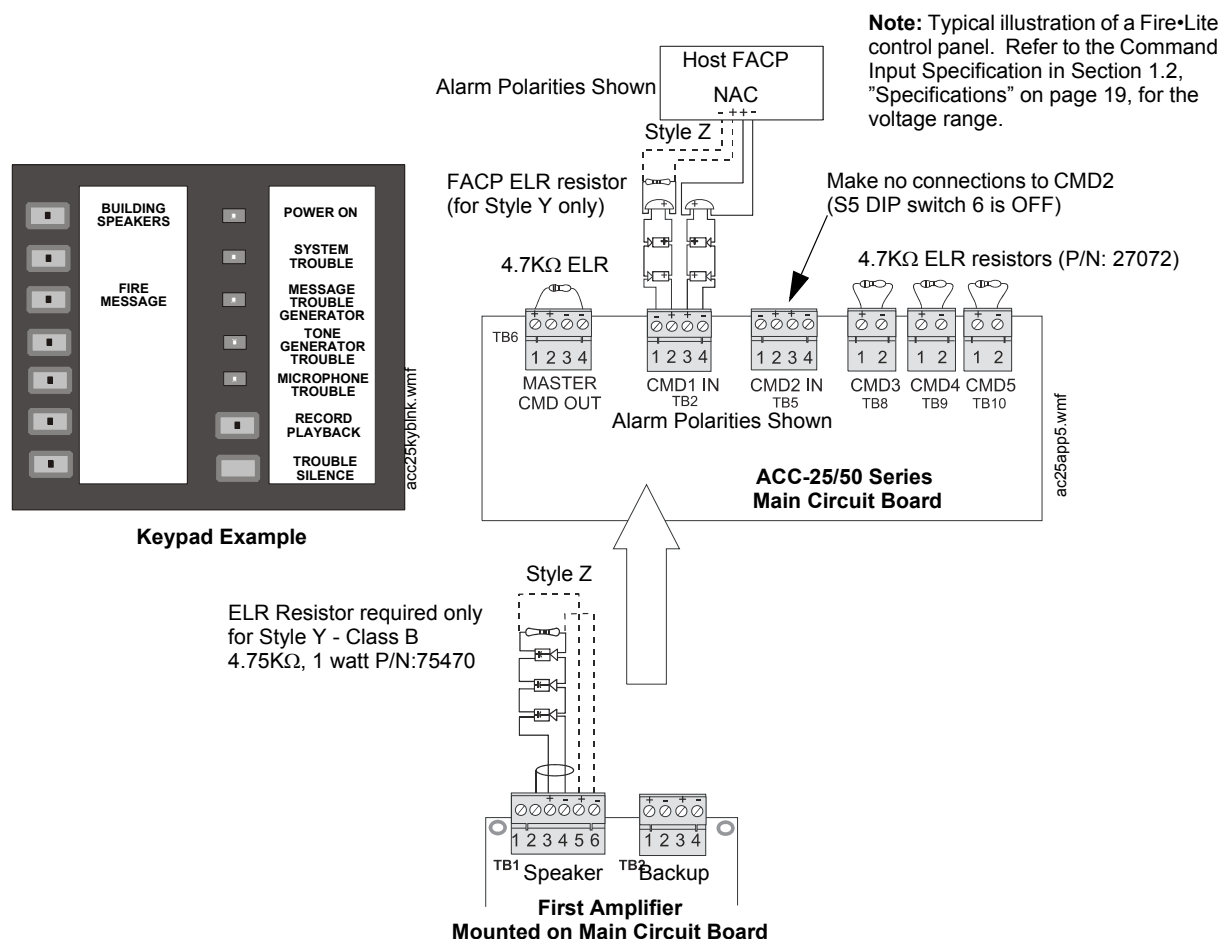

Figure 5.1 One 25 Watt Speaker Circuit

5.2 One Speaker Circuit With Backup on ACC-25/50

Single Output Zone, Single Input Channel (see Table 2.7 on page 37 for Message Control switch settings)

Another application consists of one ACC-25/50 Series with one amplifier and a single speaker circuit. A second amplifier can be installed as a backup if desired. This configuration is suitable for small facilities requiring no more than 25 watts of output power. A single 60 second fire evacuation message will be generated during an alarm condition from the host FACP or manually by a message push-button.

In this application, the NAC from the host FACP is connected to CMD1. The CMD1 out terminals are then terminated with an EOL resistor for the FACP's Style Y NAC or the terminals are wired back to the host FACP for a Style Z NAC. S3 DIP switches 1, 2 and 3 are set to OFF which causes a 60 second message to be sent to the speaker circuit when CMD1 input is activated. S5 DIP switch 5 is set to OFF which causes CMD1 input to be activated by a reverse polarity condition. CMD3, CMD4, and CMD5 inputs require End-of-Line resistors and CMD2 cannot be used to trigger the ACC-25/50.

IMPORTANT! When CMD1 is configured for reverse polarity, the NAC cannot be Coded.

Backup Amplifier switch S1 is set to the ‘Backup ON’ position. 18 AWG or larger jumpers connect the Backup Amplifier TB2 Terminal 3 and Main Amplifier TB2 Terminal 1 as well as Backup Amplifier TB2 Terminal 4 and Main Amplifier TB2 Terminal 2. Upon failure of the first or main amplifier, the audio from the backup amplifier will be switched out to the speakers.

In this application, the system may also be manually activated via the keypad by selecting the *Building Speakers* zone push-button followed by the selection of the *Fire Message* push-button, or by using the microphone to make an announcement. Refer to the Keypad example in Figure 5.2

In the optional 70.7 V_{RMS} configuration, only the amplifier is backed-up; the FC-XRM70 coupling transformer is not. For this reason, it is not necessary to install an FC-XRM70 transformer module on the backup amplifier.

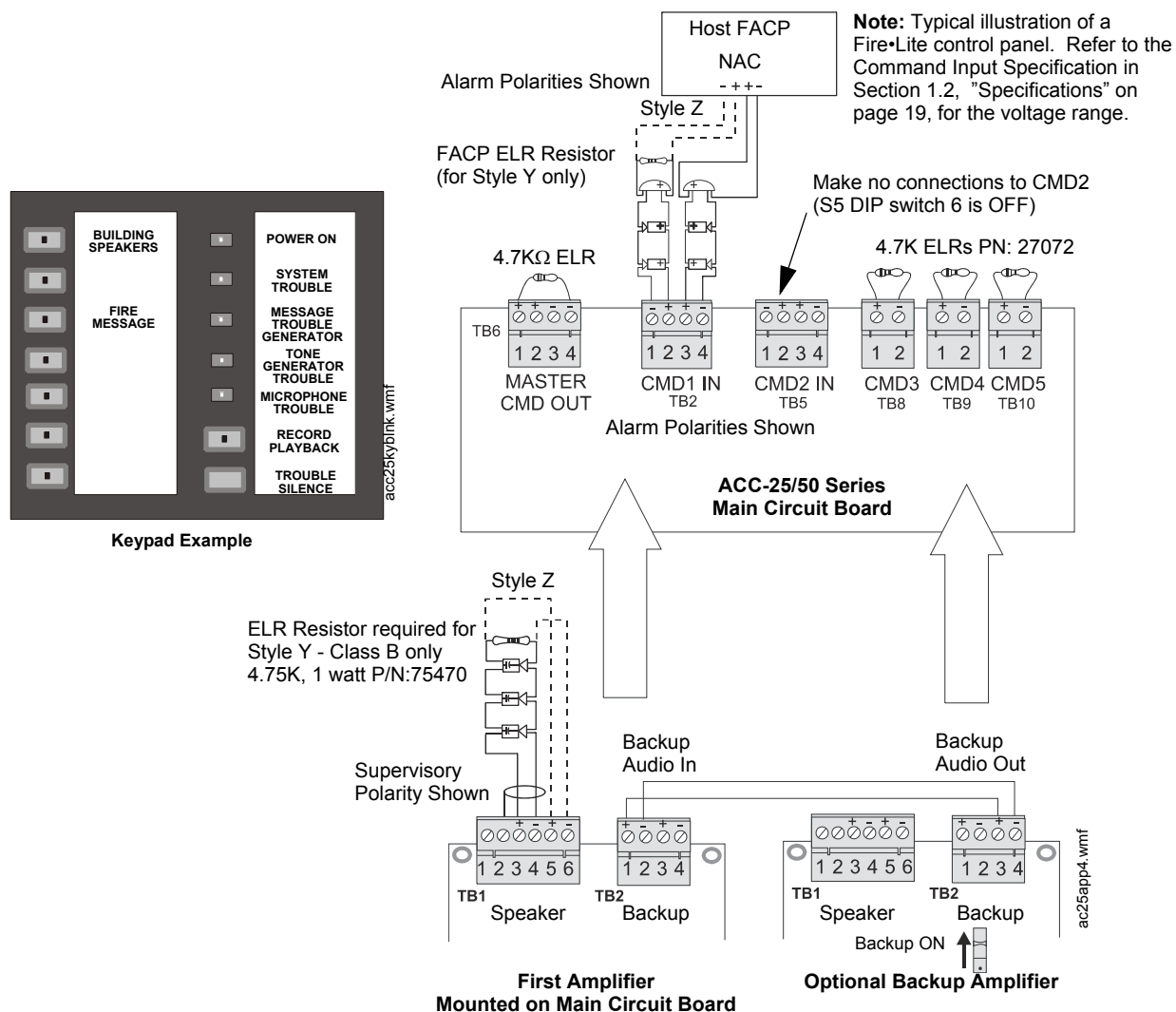

Figure 5.2 One 25 Watt Speaker Circuit With Backup

5.3 Two Speaker Circuits on ACC-25/50

Dual Output Zone, Single Input Channel - tone/voice message (see Table 2.7 on page 37 for Message Control switch settings).

This application consists of one ACC-25/50 Series with two speaker circuits which requires installation of the optional second amplifier. This configuration is suitable for small facilities requiring no more than 50 watts of output power and a 60 second fire evacuation message.

In this application, the addressable FACP directs tone or voice messages to either of the speaker circuits via the control modules which are connected to the CMD1 and CMD2 inputs. S3 DIP switches 1, 2 and 3 are set to OFF which configures CMD1/CMD2 to direct the Fire Message to the Auditorium/Classroom speakers respectively. S5 DIP switch 5 is set to ON which causes CMD1 input to be activated by a contact closure and S5 DIP switch 6 is set to ON which also causes CMD2 input to be activated by a contact closure.

The system can also be manually activated via the keypad by selecting the *Auditorium* and/or *Classroom Speakers* zone push-button followed by the selection of the *Fire Message* push-button or by using the microphone to make an announcement. Manually deactivating a speaker circuit is accomplished by pressing the activated (illuminated) output zone push-button. Refer to the keypad example in Figure 5.3.

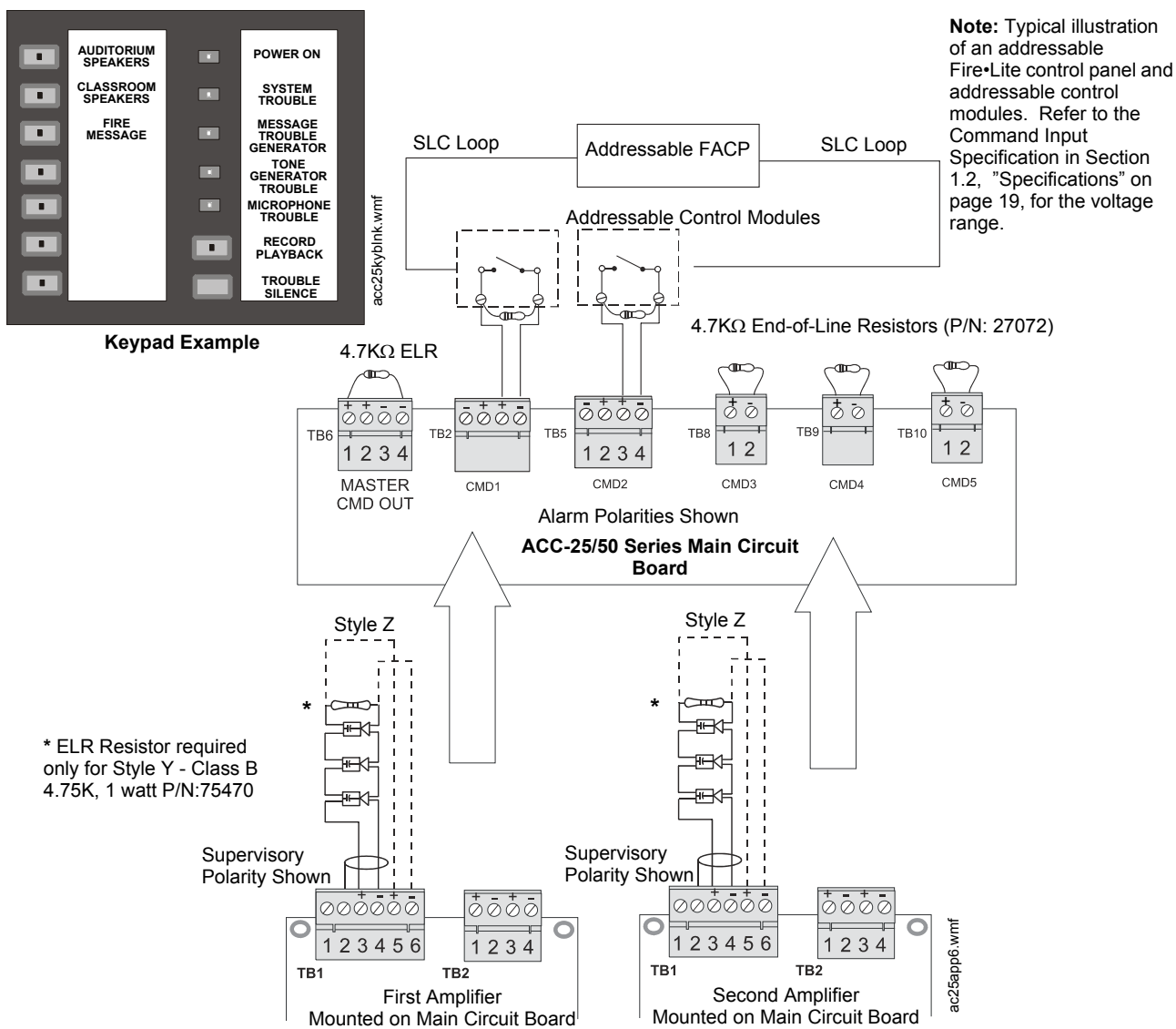

Figure 5.3 Two Speaker Circuits - Dual Output Zone, Dual Input Channel

5.4 Two Speaker Circuits on ACC-25/50

Single Output Zone, Five Input Channels - five messages (see Table 2.7 on page 37 for Message Control switch settings).

This application consists of one ACC-25/50 Series with two speaker circuits which requires installation of the optional second amplifier. This configuration is suitable for small facilities requiring no more than 50 watts of total output power. In this application, the addressable FACP utilizes addressable control modules, which are connected to CMD1 through CMD5 inputs, to direct one of the five voice messages to both speaker circuits.

S3 DIP switches 1 and 3 are set to ON and 2 is set to OFF. This causes CMD1 to activate the Fire Message, CMD2 to activate the Fire Alert Message, CMD3 to activate the Tornado Message, CMD4 to activate the Chemical Spill Message and CMD5 to activate the All Clear Message. S5 and S6 DIP switches are set to ON which causes CMD1 and CMD2 inputs respectively to be activated by a contact closure.

The system can also be manually activated via the keypad by selecting any of the Message push-buttons on the keypad. Manually deactivating the speaker circuit is accomplished by pressing the activated (illuminated) Audio On/Off push-button. To terminate the voice message, press the illuminated message push-button. Refer to the keypad example in Figure 5.3.

All Call Paging is possible by first pressing the All Call push-button on the keypad and then keying the microphone to make an announcement. Refer to the keypad example in Figure 5.4

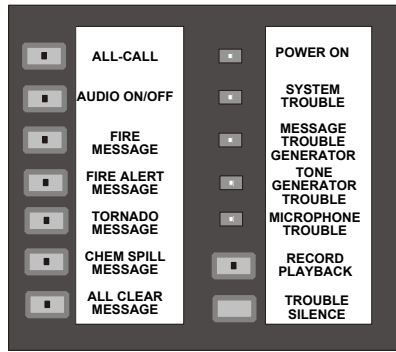

Keypad Example

Note: Typical illustration of an addressable Fire-Lite control panel and individual addressable control modules or a control multimodule. Refer to the Command Input Specification in Section 1.2, "Specifications" on page 19, for the voltage range.

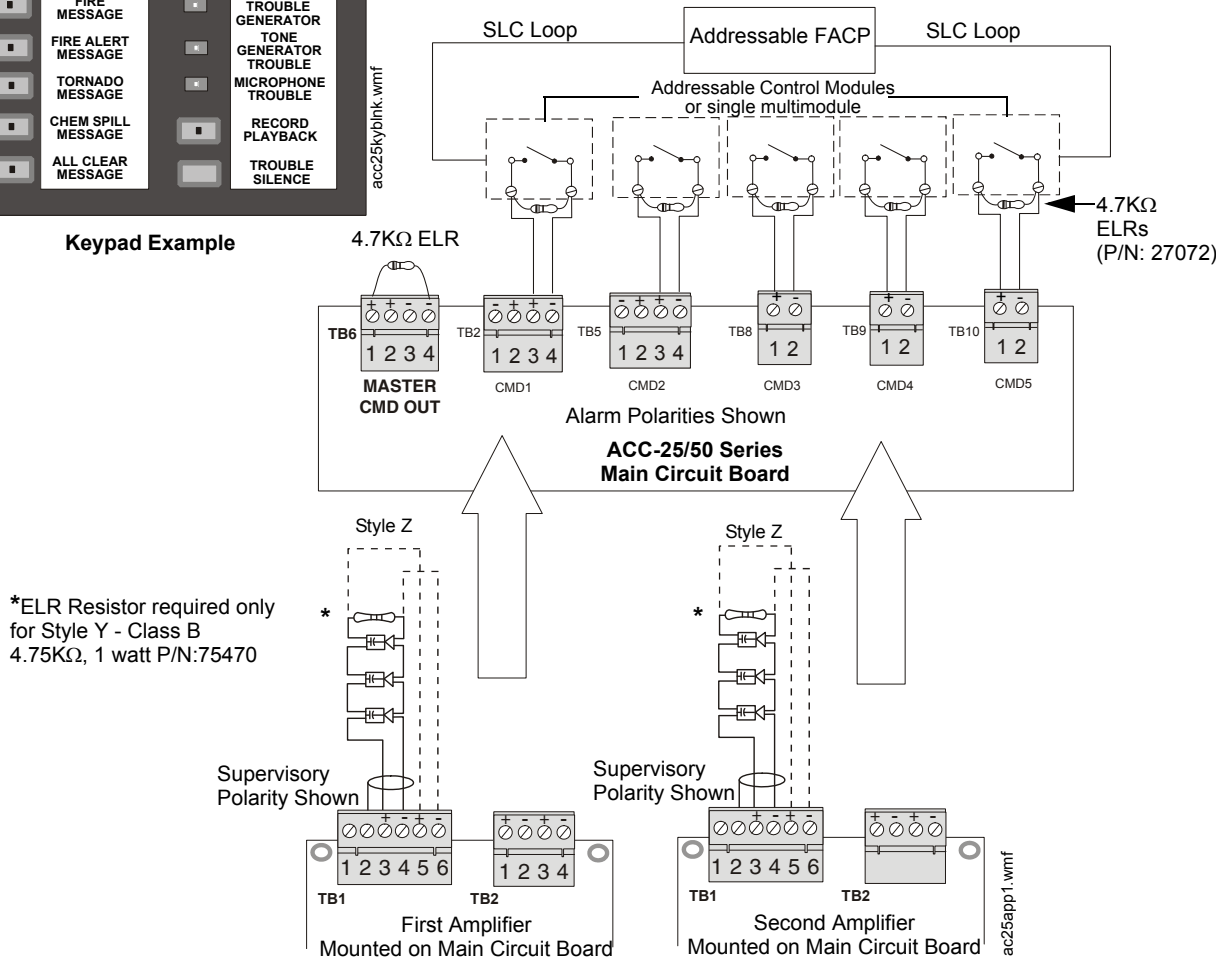

Figure 5.4 Two Speaker Circuits - Single Output Zone, Five Input Channels (five messages)

5.5 ACC-25/50ZS & ACC-25/50ZST Zone Splitting Applications

5.5.1 25 Watt Zone Splitting - Eight Speaker Circuits, Style Y (Class B)

25 watts total power with automatic control via ACS link from FACP (see Table 2.7 on page 37, Table 2.8 on page 40 and “ACC-ZSM Zone Splitter Module (ACC-25/50ZS & ACC-25/50ZST)” on page 41 for settings).

This application of the ACC-25/50ZS & ACC-25/50ZST configures the Zone Splitter Module (ACC-ZSM) to divide 25 watts of audio from one Audio Amplifier (ACC-AAM25) into eight speaker circuits. The FACP uses the ACS link connected to the Zone Page Module (ACC-ZPMK) for automatic activation of the speaker zones and for alarm activation.

Configuration switches are set as follows:

- ACC-ZSM SW1 set to *AAMI* and SW2 to *Class B* to split one ACC-AAM25 into 8 Style Y (Class B) zones
- ACC-ZPMK DIP switch S1 set for communication with:
 - ✓ MS-9200UDLS or MS-9200UD with software version 2.x (1=ON, 2=OFF, 3=ON)
 - ✓ MS-9600 with software version 2.x or higher (1=ON, 2=OFF, 3=OFF)
- ACC-25/50ZS main circuit board DIP switch S3 set for single zone mode, All-Call and two messages (1=ON, 2=OFF, 3=OFF)

The MS-9600, MS-9200UDLS, or MS-9200UD FACP can *automatically activate* the Fire Evacuation or All Clear Message and any combination of the 8 speaker zones. *Manually deactivating* a speaker circuit is accomplished by pressing the activated zone push-button on the ACC-ZPMK keypad. *Manual activation* can be performed by pressing either of the Message push-button(s) and then selecting the zone push-button on the ACC-ZPMK keypad. *All-Call Paging* is possible by first pressing the All-Call push-button on the main panel keypad and then keying the microphone to make an announcement.

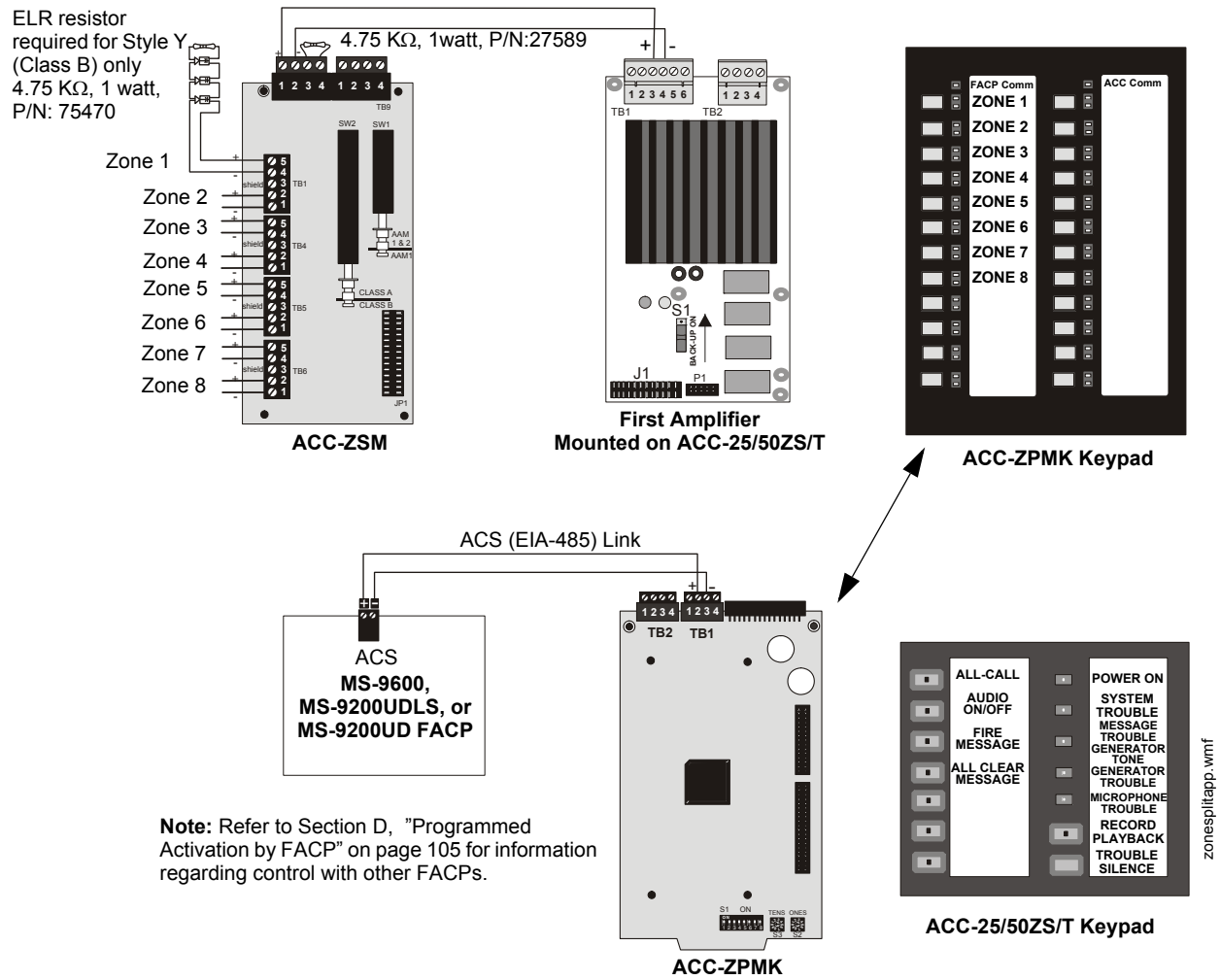

Figure 5.5 ACC-25/50ZS/T 25 Watt Zone Splitting

5.5.2 25 Watt Zone Splitting - Four Speaker Circuits, Style Z (Class A)

25 watts total power with automatic control via ACS link from the FACP (see Table 2.7 on page 37, Table 2.8 on page 40, and “ACC-ZSM Zone Splitter Module (ACC-25/50ZS & ACC-25/50ZST)” on page 41 for switch settings).

This application of the ACC-25/50ZS/T configures the Zone Splitter Module (ACC-ZSM) to divide 25 watts of audio from one Audio Amplifier (ACC-AAM25) into four speaker circuits. The FACP uses the ACS link connected to the Zone Page Module (ACC-ZPMK) for automatic activation of the speaker zones and for alarm activation.

Configuration switches are set as follows:

- ACC-ZSM SW1 set to *AAMI* and SW2 to *Class A* to split one ACC-AAM25 into 4 Style Z (Class A) zones
- ACC-ZPMK DIP switch S1 set for communication with:
 - ✓ MS-9200UDLS and MS-9200UD with software version 2.x (1=ON, 2=OFF, 3=ON)
 - ✓ MS-9600 with software version 2.x or higher (1=ON, 2=OFF, 3=OFF)
- ACC-25/50ZS/T main circuit board DIP switch S3 set for single zone mode, All-Call and two messages (1=ON, 2=OFF, 3=OFF)

The MS-9600, MS-9200UDLS, or MS-9200UD FACP can *automatically activate* the Fire Evacuation or All Clear Message and any combination of the 4 speaker zones. *Manually deactivating* a speaker circuit is accomplished by pressing the activated zone push-button on the ACC-ZPMK keypad. *Manual activation* can be performed by pressing either of the Message push-button(s) and then selecting the zone push-button on the ACC-ZPMK keypad. *All-Call Paging* is possible by first pressing the All-Call push-button on the main panel keypad and then keying the microphone to make an announcement.

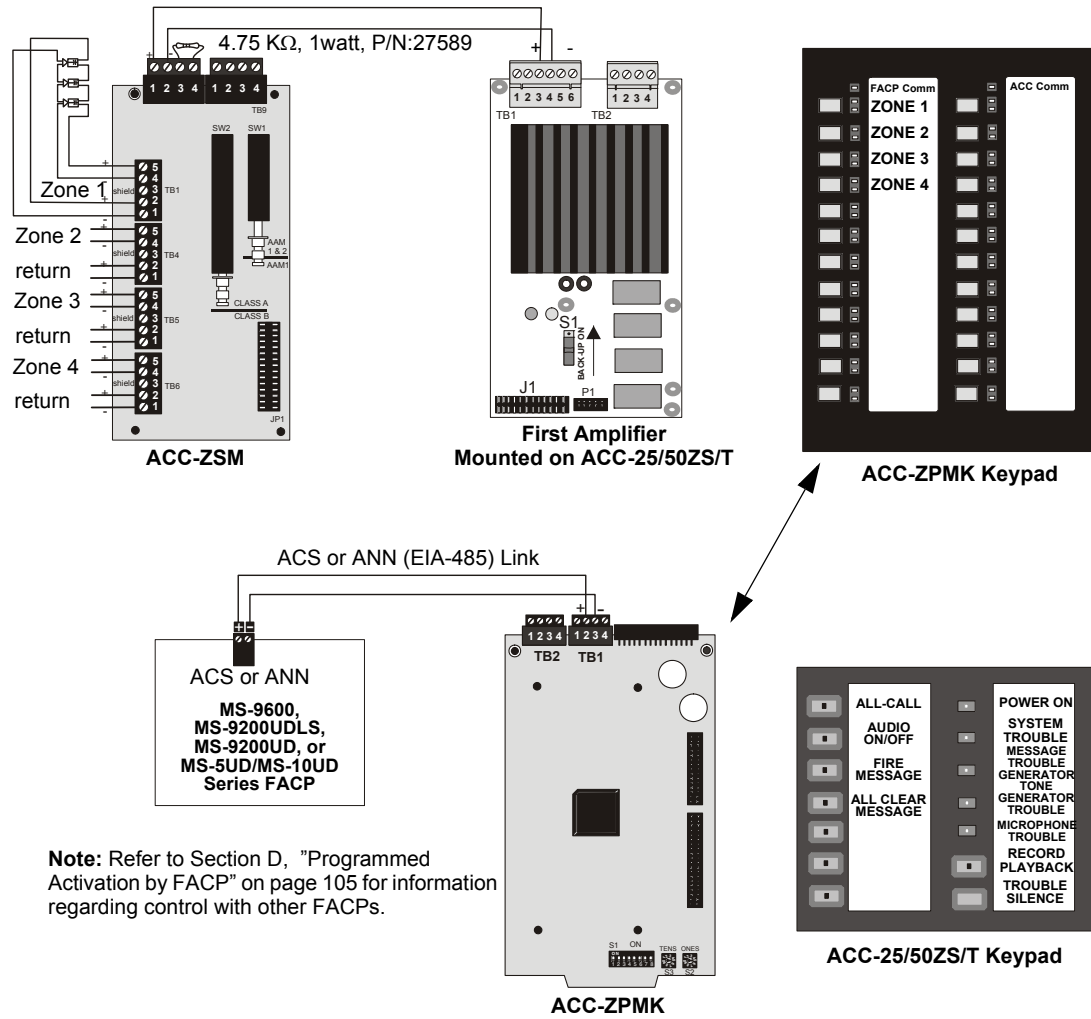

Figure 5.6 ACC-25/50ZS/T 25 Watt Zone Splitting

5.5.3 50 Watt Zone Splitting - Eight Speaker Circuits

50 watts total power with automatic control via ACS link from the FACP (see Table 2.7 on page 37, Table 2.8 on page 40, and “ACC-ZSM Zone Splitter Module (ACC-25/50ZS & ACC-25/50ZST)” on page 41 for switch settings).

This application of the ACC-25/50ZS/T configures the Zone Splitter Module (ACC-ZSM) to divide 50 watts of audio from two Audio Amplifiers (ACC-AAM25) into four speaker circuits each. The FACP uses the ACS link connected to the Zone Page Module (ACC-ZPMK) for automatic activation of the speaker zones and for alarm activation.

Configuration switches are set as follows:

- ACC-ZSM SW1 set to *AAM1 & AAM2* and SW2 to *Class B* to place speaker circuits 1-4 on AAM1 and speaker circuits 5-8 on AAM2, configured for Style Y (Class B) wiring
- ACC-ZPMK DIP switch S1 set for communication with an MS-9200UDLS, MS-9200UD software version 2.x (1=ON, 2=OFF, 3=ON) or MS-9600 software version 2.x or higher (1=ON, 2=OFF, 3=OFF)
- ACC-25/50ZS/T main circuit board DIP switch S3 set for single zone mode, All-Call and two messages (1=ON, 2=OFF, 3=OFF)

The MS-9600, MS-9200UDLS, or MS-9200UD FACP can *automatically activate* the Fire Evacuation or All Clear Message and any combination of the 8 speaker zones. *Manually deactivating* a speaker circuit is accomplished by pressing the activated zone push-button on the ACC-ZPMK keypad. *Manual activation* can be performed by pressing either of the Message push-button(s) and then selecting the Zone push-button on the ACC-ZPMK keypad. *All-Call Paging* is possible by first pressing the All-Call push-button on the main panel keypad and then keying the microphone to make an announcement.

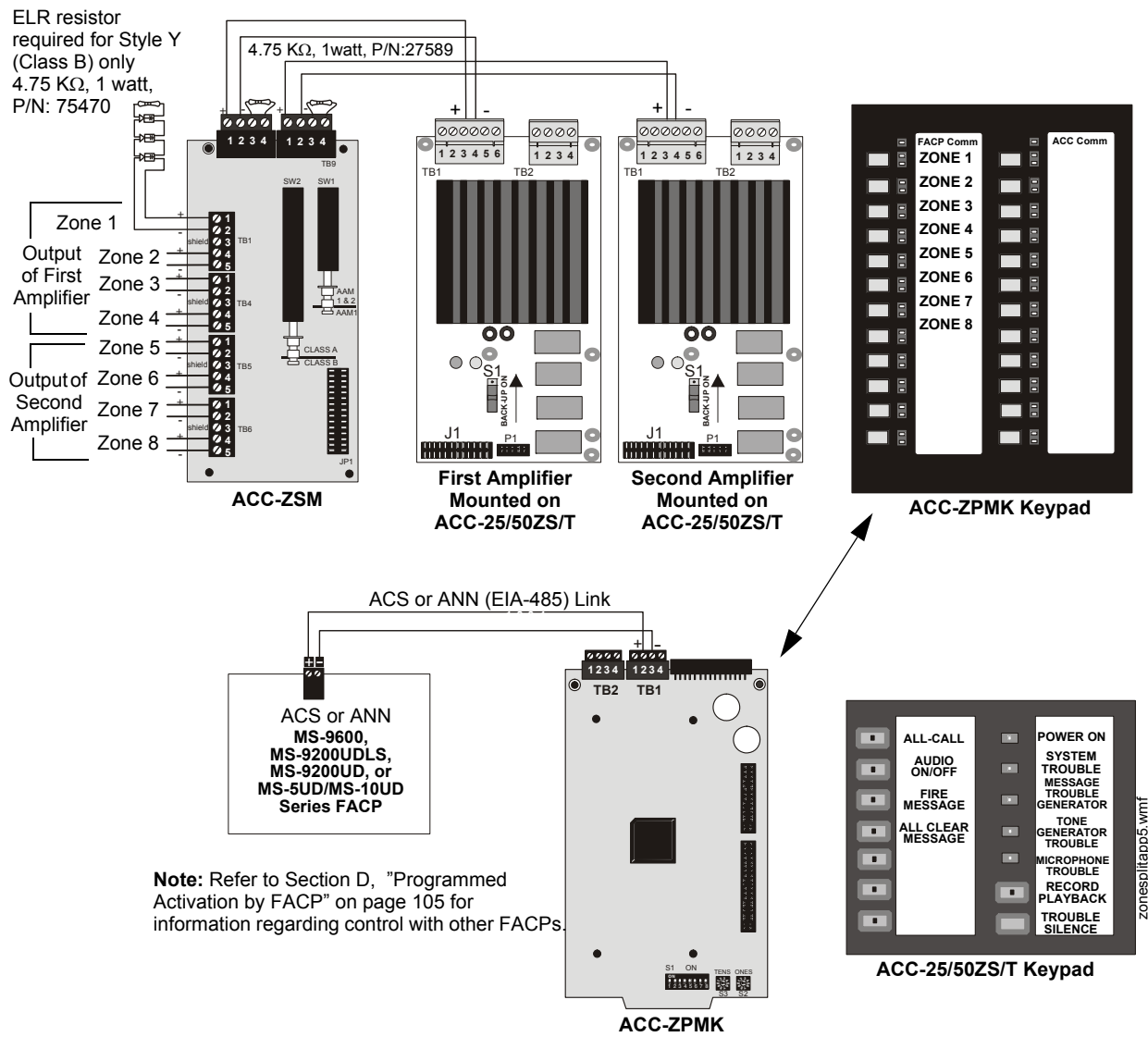

Figure 5.7 ACC-25/50ZS/T 50 Watt Zone Splitting

5.6 ACC-25/50 and ACC-25/50DA Installation

Audio Command Center 25/50 Connection to Multiple Audio Command Center 25/50 Distributed Audio Panels (see Table 2.7 on page 37 for Message Control switch settings and ACC-25/50DA Manual Doc. 52265).

This application consists of one ACC-25/50 and two ACC-25/50DA panels, supplying 150 watts of output power. The addressable FACP directs one of the five voice messages to both ACC-25/50 speaker circuits and also manages the routing of audio in the ACC-25/50DA panels via the control modules on the SLC Loop. Audio from the first amplifier of the ACC-25/50 is input to the ACC-25/50DA via the audio riser.

The ACC-25/50 is configured for single zone operation by setting S3 DIP switches 1 and 3 to ON and DIP switch 2 to OFF. This causes CMD1 to activate the Fire Message, CMD2 to activate the Fire Alert Message, CMD3 to activate the Tornado Message, CMD4 to activate the Chemical Spill Message, and CMD5 to activate the All Clear Message. The FACP can route the message generated by the ACC-25/50 to the speaker circuits of the ACC-25/50DA by activating the control module connected to CMD1 of the ACC-25/50DA or it can select the ACC-25/50DA's local message by activating the control module connected to CMD2.

All Call paging is possible by pressing the All Call button on the keypad of the ACC-25/50. This will activate the Master Command Bus and trigger the ACC-25/50DA speaker circuits. Keying the microphone will allow announcements to be made on all speaker circuits.

The Audio Command Center (ACC-25/50) can be used for systems requiring up to 50 watts of audio power. Any FACP can be used for automatic control.

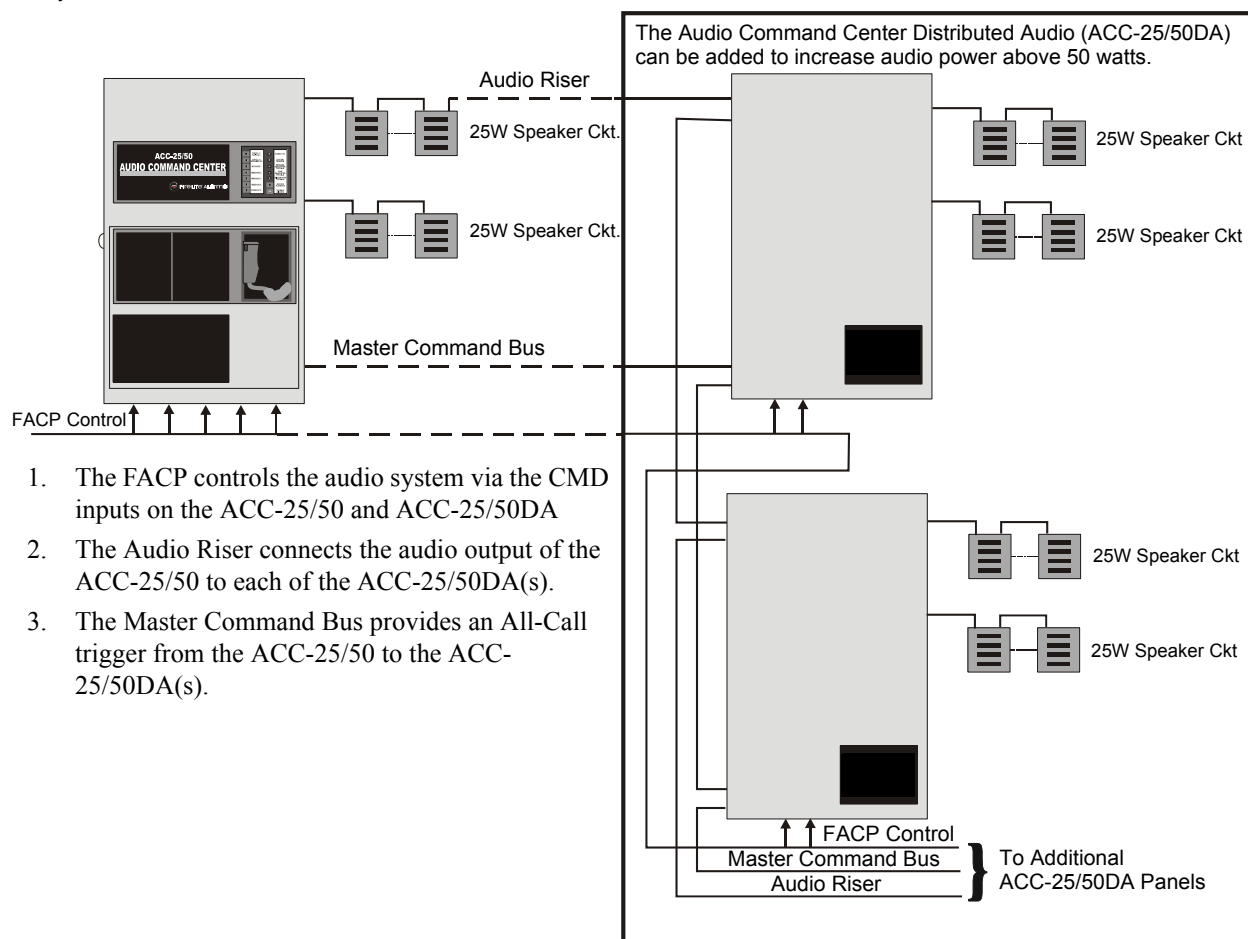
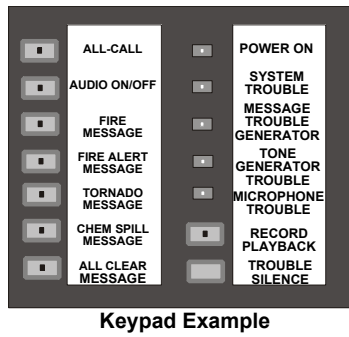

Figure 5.8 ACC-25/50 to ACC-25/50DA Connections



Note: Typical illustration of an addressable Fire•Lite control panel and addressable control modules. Refer to the Command Input Specification in Section 1.2, "Specifications" on page 19, for the voltage range.

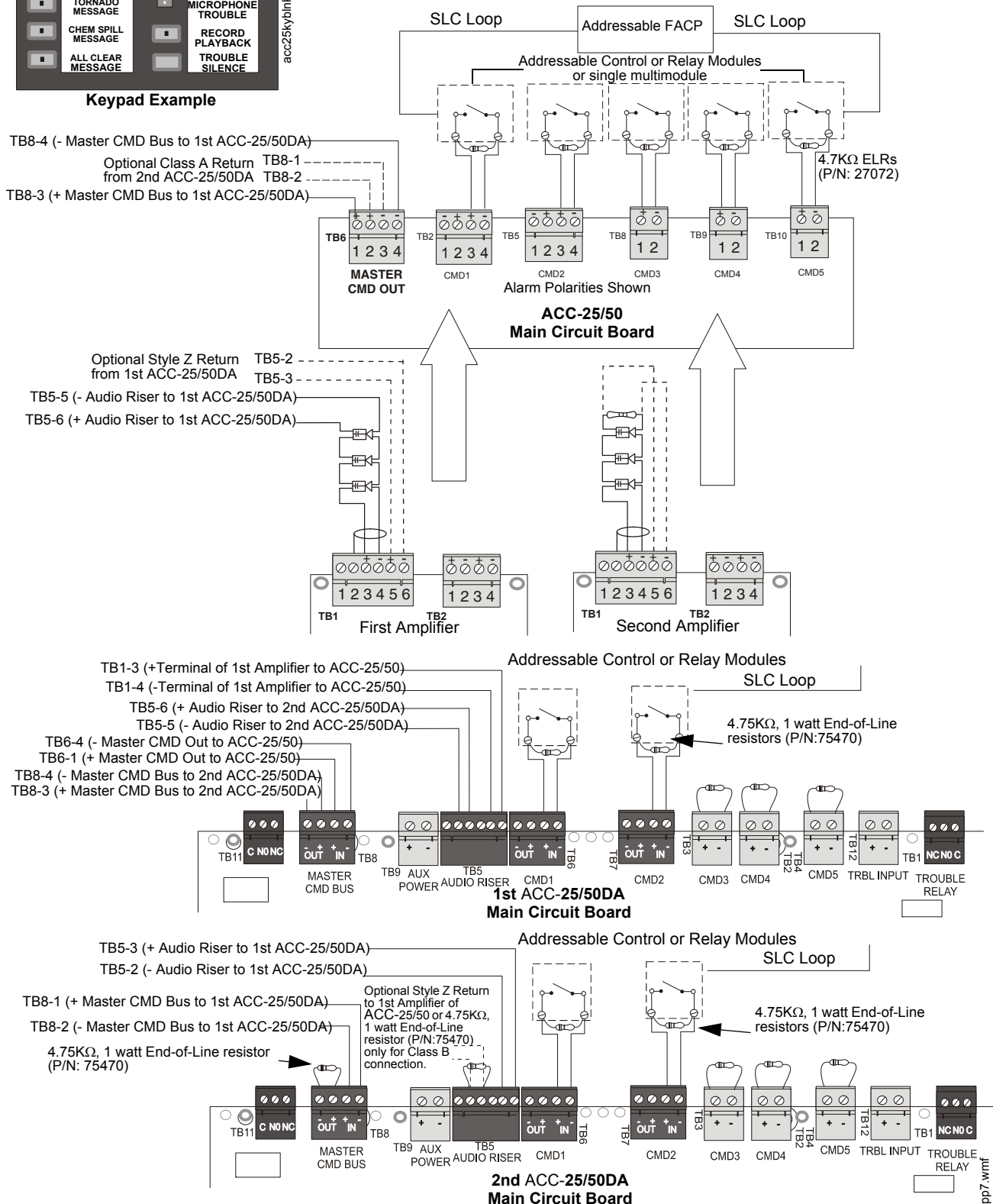

Figure 5.8 ACC-25/50 to ACC-25/50DA Terminal Connections

5.7 16 Theater Cineplex Utilizing ACC-25/50ZS With ACC-25/50DAZS

In this application, the Fire Protection System consists of one ACC-25/50ZS with one ACC-25/50DAZS, 16 zones and an addressable FACP. Each one of the 16 movie theaters is wired and assigned as a speaker circuit. The FACP is programmed for Software Zone 33 for Theater 1 through Software Zone 49 for Theater 16. Software Zone 32 is programmed to activate all speaker circuits (All-Call). In addition, the Fire Evacuation Message (Message #1) is entered into Software Zones 32 - 49.

Automatic control by the FACP is provided through the ACS link to the ACC-25/50ZS. Manual control is possible via the keypad in the ACC-25/50ZS. Control of Audio Zones 9 - 16 is sent through the ACC Control Serial Link to the ACC-25/50DAZS. Alarm and Paging audio from the ACC-25/50ZS is delivered to Audio Zones 9 - 16 (ACC-25/50DAZS) by way of the Audio Riser.

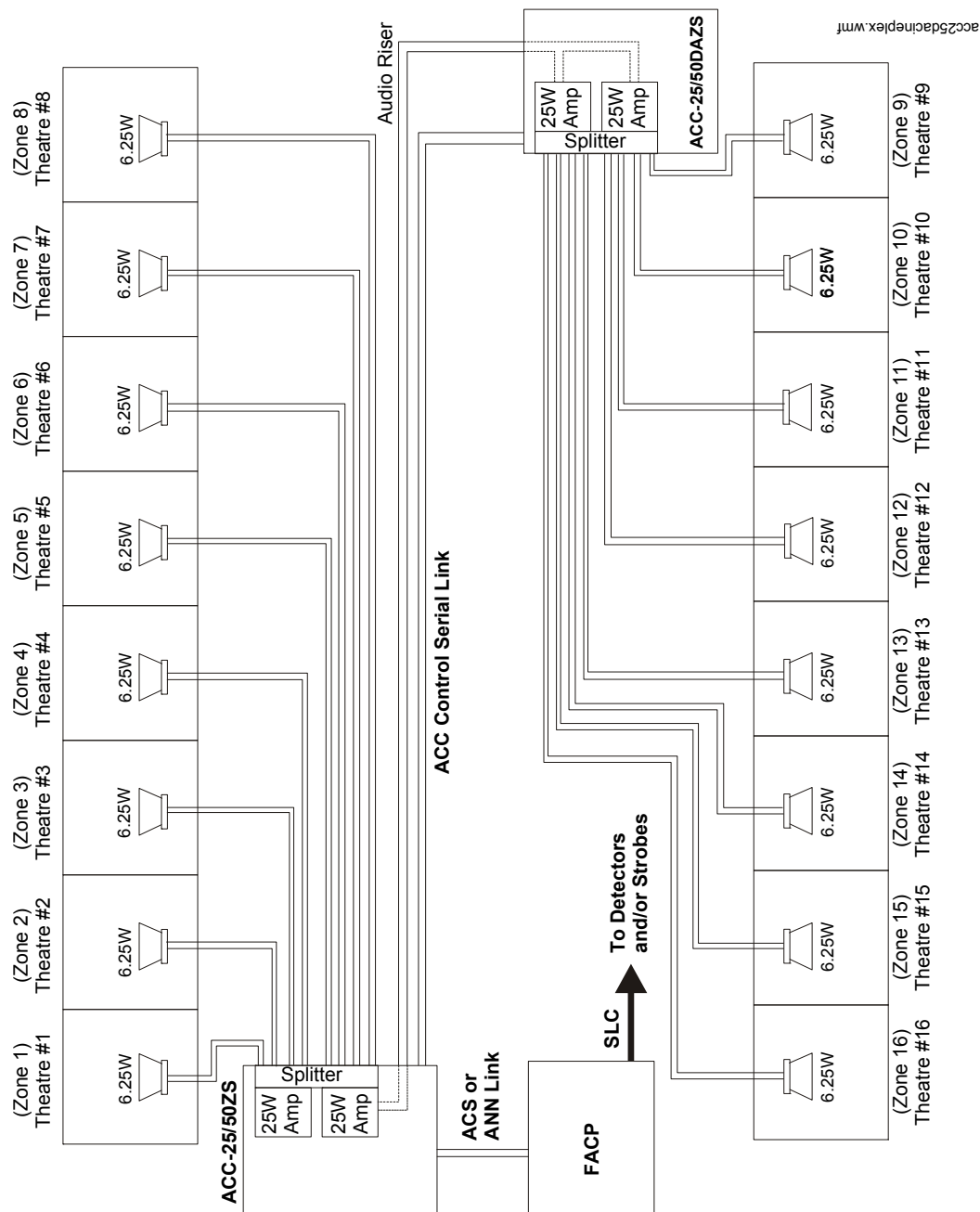

Figure 5.9 16 Theatre Cineplex

5.8 Audio Command Center 24 Zone System

In this application, the Fire Protection System consists of one ACC-25/50ZS panel with two ACC-25/50DAZS panels, 24 zones and an FACP. Automatic control by the FACP is provided through the ANN-BUS or ACS link to the ACC-25/50ZS. Manual control is possible via the keypad in the ACC-25/50ZS. Control of Audio Zones 9 - 24 is sent through the ACC Control Serial Link to the ACC-25/50DAZS Distributed Audio Panels. Alarm and Paging audio from the ACC-25/50ZS is delivered to Audio Zones 9 - 24 (ACC-25/50DAZS panels) by way of the Audio Riser.

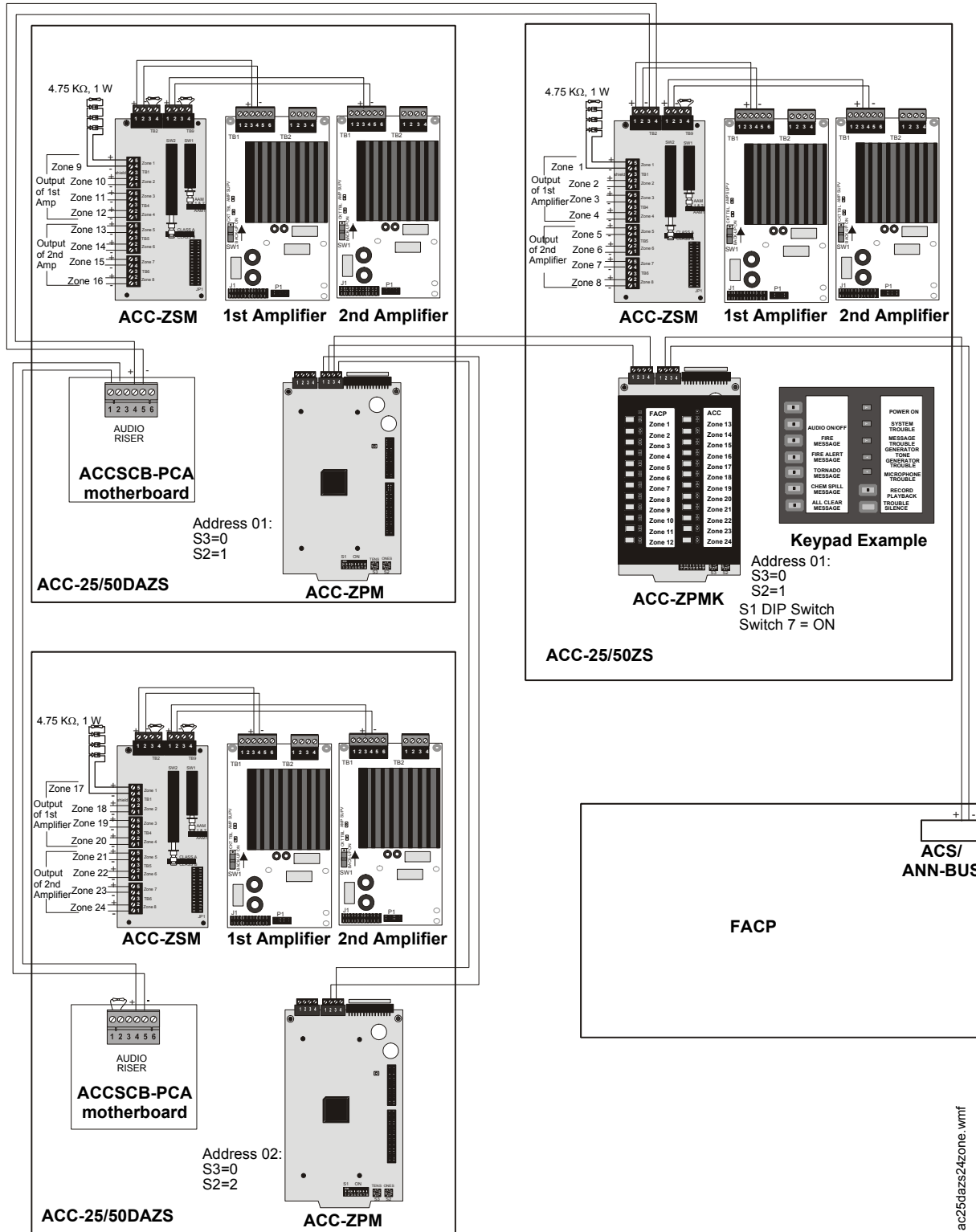

Figure 5.10 24 Zone System

acc25dazs24zone.wmf

Section 6: Power Supply Calculations

6.1 Overview

This section contains instructions and tables for calculating power supply currents in alarm and standby conditions. This is a four-step process, consisting of the following:

1. Calculating the total amount of AC branch circuit current required to operate the system
2. Calculating the power supply load current for non-fire and fire alarm conditions and calculating the secondary (battery) load
3. Calculating the size of batteries required to support the system if an AC power loss occurs
4. Selecting the proper batteries for your system

6.2 Calculating the AC Branch Circuit

The audio distribution panel requires connection to a separate, dedicated AC branch circuit, which must be labeled **FIRE ALARM**. This branch circuit must connect to the line side of the main power feed of the protected premises. No other non-fire alarm equipment may be powered from the fire alarm branch circuit. The branch circuit wire must run continuously, without any disconnect devices, from the power source to the transponder. Overcurrent protection for this circuit must comply with Article 760 of the National Electrical Codes as well as local codes. Use 14 AWG (2.00 mm²) wire with 600 volt insulation for this branch circuit.

The ACC-25/50, ACC-25/50ZS and ACC-25/50ZST require 1.5 amps from the AC branch circuit.

6.3 Calculating the System Current Draw

6.3.1 Overview

The secondary power source (batteries) must be able to power the system during a primary power loss. To calculate the non-fire alarm load on the secondary power source, use Calculation Column 1 in Table 6.3. The ACC-25/50 must support a larger load current during a fire alarm condition and primary power loss. To calculate the fire alarm load on the secondary power source, use Calculation Column 2 in Table 6.3.

When calculating current draw and the battery size, note the following:

- ‘Primary’ indicates that the audio panel is being powered by AC
- ‘Secondary’ indicates that the audio panel is being powered by battery backup during AC failure
- All currents are given in amperes (A) and refer to the DC current being supplied by the panel. Table 6.1 shows how to convert milliamperes and microamperes to full amperes

To convert...	Multiply	Example
Milliamperes (mA) to amperes (A)	mA x 0.001	3 mA x 0.001 = 0.003 A
Microamperes (µA) to amperes (A)	µA x 0.000001	300 µA x 0.000001 = 0.0003 A

Table 6.1 Converting to Full Amperes

6.3.2 How to use Table 6.2 to calculate system current draws

1. Enter the quantity of devices in both columns.
2. Enter the DC current draw where required. Refer to the *Fire•Lite Device Compatibility Document* for compatible devices and their current draw.
3. Calculate the current draws for each in both columns.
4. Sum the total current for each column.
5. Copy the totals from Column 1 and Column 2 to Table 6.3 on page 100.

Following are the types of current that can be entered into Table 6.2 :

- ✓ **Calculation Column 1** - The standby current load that the audio panel must support (from the batteries) during a non-fire alarm condition and a loss of AC power.
- ✓ **Calculation Column 2** - The alarm current draw that the audio panel must support (from the batteries) during a fire alarm condition and a loss of AC power

Table 6.2 contains two columns for calculating current draws. For each column, calculate the current and enter the total (in amps) in the bottom row. When finished, copy the totals from Calculation Column 1 and Calculation Column 2 to Table 6.3 on page 100.

Device Type	Calculation Column 1 Secondary, Non-Fire Alarm Current (amps)			Calculation Column 2 Secondary, Fire Alarm Current (amps)		
	Qty	X [current draw] =	total	Qty	X [current draw] =	total
ACC-25/50 consisting of: Main Circuit Board and one ACC-AAM25 Audio Amplifier	1	X [0.285]	=[]	1	X [2.385]	=[]
ACC-25/50ZS ¹ consisting of Main Circuit Board, one ACC-AAM25 Audio Amplifier, one ACC-ZPMK Zone Page Module and one ACC-ZSM Zone Splitter Module		X [0.440]			X [2.505]	
ACC-AAM25 Audio Amplifier Module ²	[] (1 max.)	X [0.065]=	[]	[]	X [2.00]=	[]
FC-RM Remote Microphone with ³ FC-MIM Microphone Interface Module	[] (1 max.)	X [0.006]=	[]	[]	X [0.030]=	[]
ACC-ZPMK Zone Page Module	[]	X[0.059]=	[]	[]	X[0.059]=	[]
ACC-ZSM Zone Splitter Module	[]	X[0.005]=	[]	[]	X[0.063]=	[]
ACC-FFT Fire Fighter Telephone Module ¹	[]	X[0.057]	[]		X[0.082]	[]
ACC-EPM External Page Module	[]	X [0.005]=	[]	[]	X [0.005]=	[]
Power Supervision Relays	[]	X []=	[]	[]	X []=	[]
Additional Current Draw from TB4 Special Application Auxiliary Power Output (0.035 amps maximum)	[]	X []=	[]	[]	X []=	[]
Sum each column for totals		Secondary non-alarm:		Secondary alarm:		

Table 6.2 System Current Draw Calculations

- 1 Include the ACC-25/50ZS and the ACC-FFT when calculating current draw for the ACC-25/50ZST.
- 2 In backup configurations, the optional ACC-AAM25 draws no current in alarm
- 3 Uses the same current draw whether the Remote Microphone Module is connected via the FC-MIM or ACC-FFT module.
- 4 The FC-XRM70 Transformer Module draws no current in standby or alarm
- 5 The FC-LPS Local Playback Speaker Module draws no current in standby or alarm
- 6 The ACC-25/50 will turn off the background music in the event AC power is lost in order to conserve battery power.
- 7 Refer to the Fire•Lite Device Compatibility Document for compatible devices and their current draws

6.4 Calculating the Battery Size

Use Table 6.3 to calculate the total Standby and Alarm load in ampere hours (AH). This total load determines the battery size (in AH), required to support the ACC-25/50 Series under the loss of AC power. Complete Table 6.3 as follows:

1. Enter the totals from Table 6.2 on page 99 Calculation Columns 1 and 2 where shown.
2. Enter the NFPA Standby and Alarm times (refer to Section 6.4.1, "NFPA Battery Requirements").
3. Calculate the ampere hours for Standby and Alarm, then sum the Standby and Alarm ampere hours.
4. Multiply the sum by the derating factor of 1.2 to get the proper battery size (in AH).
5. Write the ampere hour requirements on the Protected Premises label located inside the cabinet door.

Secondary Standby Load (total from Table 6.2 Calculation Column 1) []	Required Standby Time (24 or 60 hours) []	=	AH
Secondary Alarm Load (total from Table 6.2 Calculation Column 2) []	Required Alarm Time (for 5 min., enter 0.084, for 10 min., enter 0.168, for 15 min., enter 0.250) []	=	AH
Sum of Standby and Alarm Ampere Hours		=	AH
Multiply by the Derating Factor			X 1.2
Battery Size, Total Ampere Hours Required		=	AH

Table 6.3 Total Secondary Power Requirements at 24 VDC

6.4.1 NFPA Battery Requirements

NFPA requires 24 hours of standby plus 15 minutes activation for audio systems. The total ampere hours required cannot exceed 18 AH with an internal charger. An external charger can be used to increase the total ampere hours (internal charger must be disabled).

6.4.2 Selecting and Locating Batteries

Select batteries that meet or exceed the total ampere hours calculated in Table 6.3. The audio panel can charge batteries in the 7 AH to 18 AH range. The ACC-25/50 Series can house up to 18 AH batteries.

Notes

Appendix A: Digital Voice Messages

The AUDIO•COMMAND•CENTER•25/50 Series digital message generator provides a 60 second record time which allows for a single fire message of 60 seconds length, two 30 second messages, three 20 second messages, four 15 second messages or five 12 second messages, any of which may be field programmed. Refer to Section 4.1.5, "Record/Playback Button - Record Customized Messages" on page 64. The AUDIO•COMMAND•CENTER•25/50 Series is provided with a factory recorded single 'primary' message which can be changed in the field. The prerecorded message (female voice) is:

"May I have your attention please. May I have your attention please. The signal you have just heard indicates a report of a fire in this building. Please proceed to the nearest exit and leave the building. Do not reenter the building unless directed to do so by the proper authorities."

New messages can be recorded in the field. Be certain to get the approval of the Local Authority Having Jurisdiction prior to recording new messages. Following are some examples of messages which may be recorded in the field:

- "May I have your attention please. May I have your attention please. There has been a fire reported on your floor. There has been a fire reported on your floor. Please proceed to the stairways and exit the building. Do not use the elevators."
- "May I have your attention please. May I have your attention please. There has been a fire alarm reported in the building. There has been a fire alarm reported in the building. Please proceed to the stairways and exit the building. Do not use the elevators, but proceed to the stairways and exit the building."
- "May I have your attention please. May I have your attention please. A tornado warning has been issued for this area. A tornado warning has been issued for this area. Please take all appropriate safety actions at this time."
- "May I have your attention please. May I have your attention please. A hurricane warning has been issued for this area. A hurricane warning has been issued for this area. Please take all appropriate safety actions at this time."
- "May I have your attention please. May I have your attention please. An emergency condition exists on this floor. An emergency condition exists on this floor. Please proceed to the stairways and exit the building. Do not use the elevators."
- "May I have your attention. This is an emergency. Please walk to the nearest exit and go to your assembly areas and await further instructions. This is an emergency."
- "Your attention please. The fire alarm in this building has been activated. Please cease operations immediately and proceed into the nearest fire exit. Descend to street level and leave the building. Do not use the elevator."
- "There has been a Fire Emergency reported in this building. Proceed calmly to fire stairs. Do not use elevators. Do not contact the front desk unless evacuation assistance is required. Proceed directly to fire stairs. Fire personnel will assist disabled and elderly from the fire stairs. Floor Wardens report status by fire phone."
- "May I have your attention please. There has been a Fire Emergency reported in the building. While this is being verified, please leave the building by the nearest exit or exit stairway."
- "Attention. Your attention please. The building emergency condition has been cleared. You may return to your normal activities. The building emergency has been cleared. You may return to your normal activities."
- "Your attention please. A severe weather warning has been received. Please walk to the nearest safe area and wait for further instructions. Elevator lobbies, stairwells, bathrooms and auditoriums are designated safe areas in the event of severe weather. Stay away from windows and glass. Do not use the elevators."

Appendix B: Addressable Module Connections

When configured with an addressable FACP such as the MS-9200UDLS, MS-9200UD, MS-9200C(E), or MS-9600, the AUDIO•COMMAND•CENTER•25/50 Series may be triggered either by the FACP main NAC output or from addressable control modules. Figure B.1 illustrates CMD1 triggered by an addressable control module. The addressable control module may trigger the ACC-25/50 Series via reverse polarity (shown) or relay contact. The FACP monitors the ACC-25/50 Series for faults while in the standby or alarm state by wiring a monitor module to the trouble contacts as shown in Figure B.1. Activation of the addressable control module is controlled by the FACP. Refer to the MS-9200UDLS, MS-9200UD, MS-9200C(E), or MS-9600 manual for additional information.

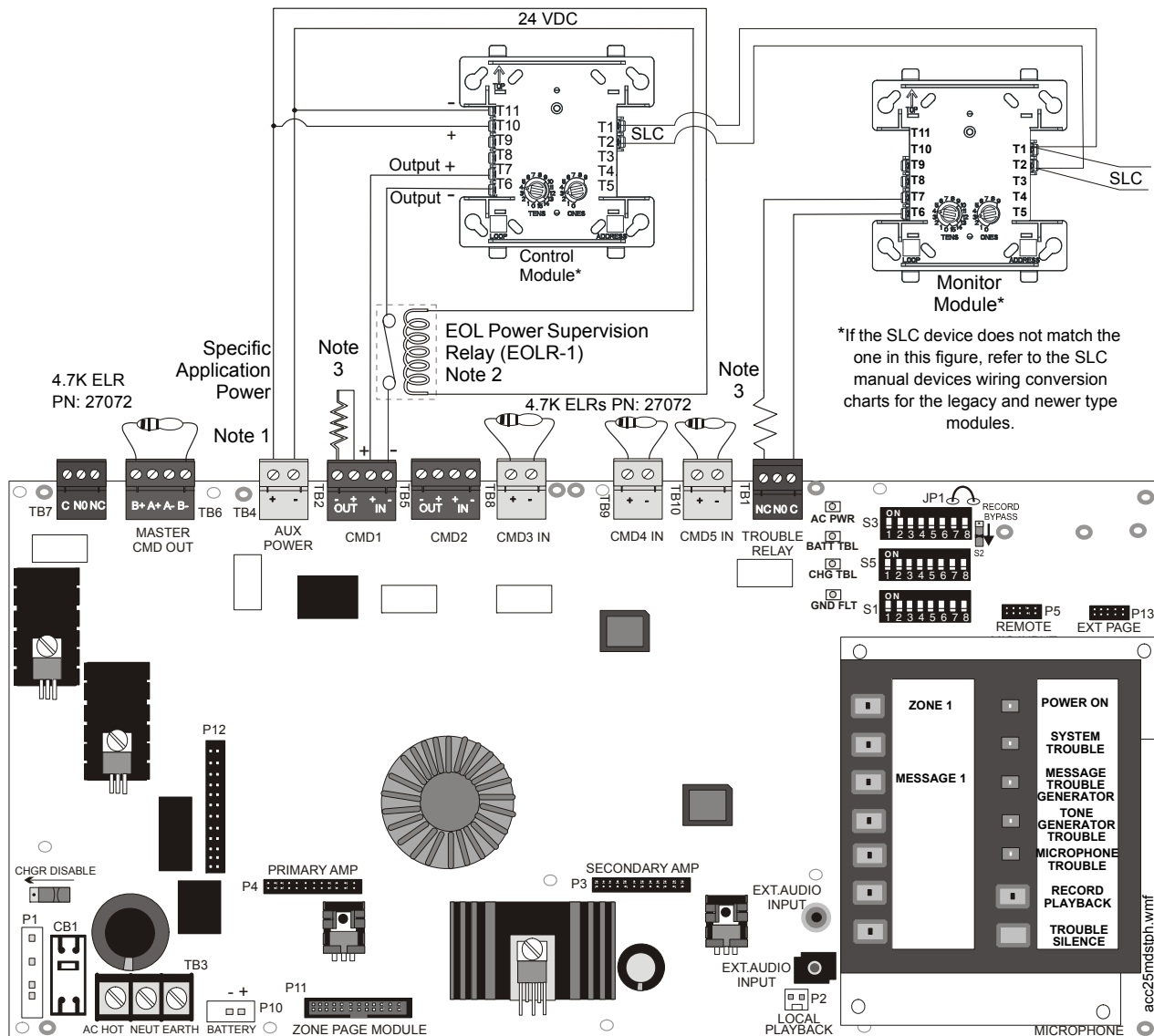

Figure B.1 Addressable Module Connections

Notes:

1. Auxiliary Power terminals for special application power only. Wiring must remain in the room.
2. Supervise the wiring between the ACC-25/50 Series Auxiliary Power output and the control module with an EOL relay (EOLR-1).
3. End-of-Line resistor supplied with modules.

Appendix C: Wiring Requirements

Connecting external system accessories to the AUDIO•COMMAND•CENTER•25/50 Series main circuits must be carefully considered to ensure proper operation. It is important to use the correct type of wire, wire gauge and wire run length per each circuit. Refer to the following table to specify wire requirements and limitations.



NOTE: If an SLC loop is to be run in conduit with AUDIO•COMMAND•CENTER•25/50 Series Notification Appliance Circuits, the risk of encountering problems can be greatly reduced by using twisted, shielded cable on the SLC and NACs.

CIRCUIT CONNECTIONS		WIRE REQUIREMENTS		
Circuit Type	Circuit Function	Wire Type & Limitations	Recommended Maximum Distance (Feet)	Wire Gauge
AC Power TB3 (nonpower-limited)	Primary Power Input to ACC-25/50 Series, AC Voltage	See Note ¹	Power Supplied must be: 120 VAC, 60 Hz, 1.5 amps (see Note ¹)	Terminals Support 12-18 AWG (see Note ¹)
Audio Output ACC-AAM25 Module TB1 and ACC-ZSM Module (power-limited)	Notification Appliance Circuit	See Note ² Untwisted, unshielded or twisted, shielded	See Note ³	12 - 18 AWG
ACC-ZPMK Module	ACS (EIA-485 Circuit)		4,000 feet	12 - 18 AWG
ACC-FFT TB1	Telephone Loop	See Note ² Untwisted unshielded or twisted, shielded	54Ω maximum impedance	12 - 18 AWG
ACC-FFT TB2	Contact Closure Input Trigger	Untwisted unshielded	54Ω maximum impedance	12 - 18 AWG
ACC-FFT TB3	Remote Microphone Connection ⁴	See Note ⁴	See Note ⁴	See Note ⁴
ACC-EPM Module	External Page Connection			12 - 18 AWG
CMD1 and CMD2 Main Board TB2 and TB5	Triggers ACC-25/50 Series	See Note ¹ Untwisted, unshielded or twisted, shielded	Depends on Output (trigger) Circuit 9 - 32 VDC, 1.6 mA for polarity reversal relay must be rated at 0.5 amp, 24 VDC	12 - 18 AWG
CMD3, CMD4 and CMD5 Main Board TB8, TB9 and TB10	Triggers ACC-25/50 Series	See Note ¹ Untwisted, unshielded or twisted, shielded	Depends on Output (trigger) Circuit from contact device	12 - 18 AWG
Main Board TB6 Master Command Bus Reverse Polarity (power-limited)	Output Trigger for Multiple ACC-25/50 Series configurations	Untwisted, unshielded	200 ohms maximum	12 - 18 AWG
Trouble Relay Main Board TB1	Trouble Output	Maximum Current 2 amps	Depends on Input Circuit	12 - 18 AWG
AC Loss Relay Main Board TB7	AC Loss Output	Maximum Current 2 amps	Depends on Input Circuit	12 - 18 AWG

Table C.1 AUDIO•COMMAND•CENTER•25/50 Series Wiring Requirements

- 1 Refer to NEC Standards.
- 2 Twisted, shielded wire is recommended for maximum protection against EMI and AFI emissions and susceptibility.
- 3 Must also meet NFPA 72 Standards for minimum and maximum sound levels.
- 4 Refer to *Remote Microphone Document #51247*.

Appendix D: Programmed Activation by FACP

The Audio Command Center Zone Split system (ACC-25/50ZS/T) can be automatically controlled by any FACP. The following table lists the available audio features and the control signals that are required from the FACP.

FACP	ACC-ZPMK S1 DIP Switch Settings 1 2 3	Individual Audio Zone Control via Serial Link		Individual Control of All Messages			Simultaneous Activation of All Audio Zones ¹	Fire Fighter Telephone Remote Annunciation via Serial Link	
		ACS	ANN	ACS	ANN	CMD		ACS	ANN
Non-ACS/ANN-BUS FACP or MS-9200UD version 1 ²	0 0 0	No	No	No	No	Yes	Yes	No	No
MS-5210UD	0 0 1	Yes	No	No ^{3,4}	No	Yes ³	No	No	No
MS-9200	0 1 0	Yes	No	No ³	No	Yes ⁵	Yes	Yes	No
MS-9600 version 1	0 1 1	Yes	No	No ⁴	No	Yes ⁵	Yes	Yes	No
MS-9600 version 2 or 3	1 0 0	Yes	No	No	No	Yes ⁶	Yes	Yes ⁷	No
MS-9200UDLS or MS-9200UD version 2 or 3	1 0 1	Yes	No	Yes	No	Yes ⁷	Yes	Yes ⁷	No
MS-9200UDLS version 4 or higher	1 1 0	Yes	Yes	Yes	Yes	Yes	Yes	Yes ⁸	Yes
MS-9600LS version 4 or higher	1 1 0	Yes	Yes	Yes	Yes	Yes	Yes	Yes ⁷	Yes
MS-5UD-3/7 or MS-10UD-3/7 version 2 or higher	1 1 0	No	Yes	No	Yes	Yes ⁹	Yes	No	No
future	1 1 1								

Table D.1 FACP Message/Zone Control of the ACC-25/50ZS/T

- 1 There may be up to an 8 second delay between alarm indication on the FACP and activation of the message and speaker zones on the ACC-25/50ZS/T.
- 2 ACS link control utilizing the MS-9200UD version 1 is not available.
- 3 The MS-5210UD can control up to 5 messages via the ACS link using the ACM-8RF Relay Module.
- 4 Only Message #1 can be automatically activated by the FACP via ACS control.
- 5 Program Software Zone 32 in the FACP to activate all the Audio Zones on the ACC-25/50ZS/T.
- 6 For CMD Input Control using version 2 or higher, set the ACC-ZPMK DIP switch for MS-9600 version 1.
- 7 Enable ACS address 07 to annunciate remote FFT locations.
- 8 Enable ACS address 05 to annunciate remote FFT locations.
- 9 For CMD Input Control using the MS-5UD-3/7 or MS-10UD-3/7, set the ACC-ZPMK DIP switch for Non-ACS/ANN-BUS FACP.

Column Descriptions for Table D.1

- *FACP* - the Fire Alarm Control Panel being used
- *ACC-ZPMK S1 DIP switch Setting* - the DIP switch setting on the ACC-ZPMK in accordance with the FACP installed
- *Individual Audio Zone Control via ACS/ANN-BUS Link* - ACS or ANN-BUS compatible FACP's can control each audio zone on the ACC-25/50ZS or ACC-25/50ZST (refer to the FACP specific programming sections in this Appendix)
- *Individual Control of All Messages* - control of all voice messages in the ACC-25/50ZS or ACC-25/50ZST can be accomplished through the ACS/ANN-BUS link or by triggering the CMD inputs (refer to the FACP specific programming sections in this Appendix.)

- *Simultaneous Activation of All Audio Zones* - this is a single trip mechanism via a zone on the ACS/ANN-BUS link or CMD input trigger that activates all the audio zones at the same time (refer to the FACP specific programming sections in this Appendix.)
- *Fire Fighter Telephone Remote Annunciation via ACS/ANN-BUS* - an intelligent FACP utilizing addressable monitor modules and the ACS/ANN-BUS link can annunciate the status of the remote FFT jacks (refer to the FACP specific programming section in this Appendix.)

D.1 MS-9600, MS-9200UDLS and MS-9200UD

The ACC-25/50ZS and ACC-25/50ZST can be automatically triggered via the ACS serial link by the MS-9600 (version 2 or higher), MS-9200UDLS and MS-9200UD (version 2 or higher) to transmit one of five messages over selected speaker circuits. This is accomplished by zone programming at the FACP.

Annunciation of remote Fire Fighter Telephone locations on the ACC-FFT keypad (ACC-25/50ZST only) is also transmitted via the ACS serial link. This is accomplished by point programming at the FACP.

D.1.1 Overview

The ACC-25/50ZS and ACC-25/50ZST provide 8 speaker circuits standard via the ACC-ZSM Zone Splitter Module. Expansion to 24 speaker circuits is possible by adding ACC-25/50DAZS panels. The ACC-25/50ZS and ACC-25/50ZST also have the ability to generate and direct one of five messages to specific speaker circuits.

The MS-9600, MS-9200UDLS, and MS-9200UD communicate with the ACC-25/50ZS and ACC-25/50ZST over the ACS annunciator terminals. The ACS Annunciator option for ACS address 01 must therefore be enabled in the FACP programming. When this option is enabled, FACP zones Z33 through Z56 are dedicated as output zones for speaker circuits 1 through 24 respectively. FACP Zone 32 is dedicated to turn on all speaker circuits. The FACP will then allow the installer to program individual addressable devices to any of the speaker circuits using the Zone Setup menu. In addition, one of five messages can be generated over the selected speaker circuit.

To annunciate remote Fire Fighter locations in the ACC-25/50ZST, ACS address 07 must be enabled in the MS-9200UDLS or address 05 for version 4 or higher; or ACS address 07 for the MS-9600. When this option is enabled, SLC points 75-98 on the MS-9200UDLS or SLC points 135-158 on loop #1 of the MS-9600 are dedicated to FFT 1-24 indicators on the ACC-FFT keypad.

All faults on the ACC-25/50ZS and ACC-25/50ZST are sent upstream via the ACS link to the MS-9600, MS-9200UDLS, or MS-9200UD and are indicated as an *ACS Fault* on the display.

Important Notes:

1. For proper operation, a message must be assigned to each zone that is programmed to activate an audio speaker circuit.
2. The message repeat setting on the ACC-25/50ZS and ACC-25/50ZST should be set to infinite. This will ensure that lower priority activated zones will continue to broadcast the voice message.
3. CMD inputs are not used for activation of the ACC-25/50ZS and ACC-25/50ZST, however, 4.7K Ω ELRs must still be connected across CMD3, CMD4, and CMD5.
4. When implementing annunciation of remote FFT locations, the ACC-25/50ZST defaults to *receive only mode* for ACS address 05 or ACS address 07.

D.1.2 Basic MS-9600/MS-9200UD/MS-9200UDLS & ACC-25/50ZS/T Step-By-Step Install/Setup

1. Connect ACS wiring from FACP to ACC-25/50ZS or ACC-25/50ZST.
2. Set ACS Address Wheels on ACC-ZPMK to address 01.

3. Set DIP Switches 1, 2, and 3 on Switch S1 of the ACC-ZPMK for operation with the MS-9600, MS-9200UD, MS-9200UDLS FACP and switches 6, 7, and 8 for the number of ACC-25/50DAZS panels.
4. Set Switch SW1 on the ACC-ZSM for one or two Audio Amplifier (ACC-AAM25) configuration.
5. Set Switch SW2 on the ACC-ZSM for Style Y (Class B) or Style Z (Class A) speaker circuit wiring.
6. Set DIP switches 1, 2, and 3 on Switch S3 of the ACC-25/50ZS or ACC-25/50ZST motherboard for Single Zone with activation of 2-5 messages.
7. Record any new messages into the ACC-25/50ZS or ACC-25/50ZST.
8. Enable ACS communication to address 01 and assign messages (1-5) to audio zones (32-56) in the FACP.
9. ACC-25/50ZST with remote FFT location annunciation:
 - MS-9200UDLSMS-9200UDLS - Enable ACS address 07 or address 05 (for version 4 and higher) and program SLC points 75-98.
 - MS-9600 - Enable ACS address 07 and program SLC loop #1 points 135-158.

D.1.3 Wiring From ACC-25/50ZS or ACC-25/50ZST to FACP

MS-9600 and MS-9600LS

The FACP communicates with the ACC-25/50ZS/T over the ACS or ANN-BUS annunciator link. Wiring must be connected between Terminal TB6 on the FACP and Terminal TB1 on the ACC-ZPMK Zone Page Module installed on the ACC-25/50ZS/T panel.

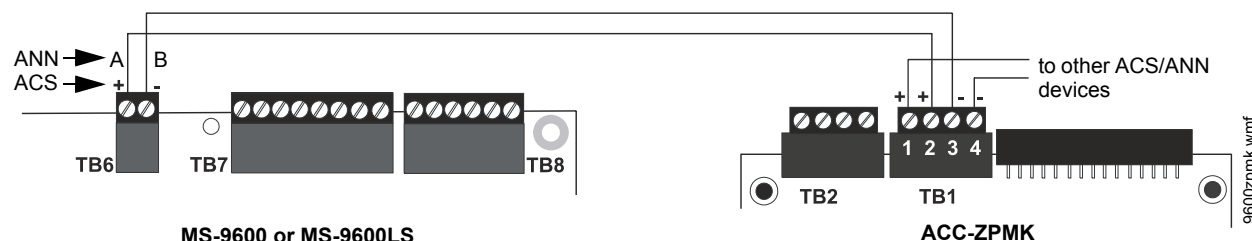

Figure D.1 Connection for MS-9600 or MS-9600LS to ACC-ZPMK

MS-9200UD and MS-9200UDLS

The MS-9200UD and MS-9200UDLS FACP communicate with the ACC-25/50ZS or ACC-25/50ZST over the ACS or ANN-BUS annunciator link. Wiring must be connected between Terminal TB9 on the FACP and Terminal TB1 on the ACC-ZPMK Zone Page Module installed on the ACC-25/50ZS or ACC-25/50ZST panel.

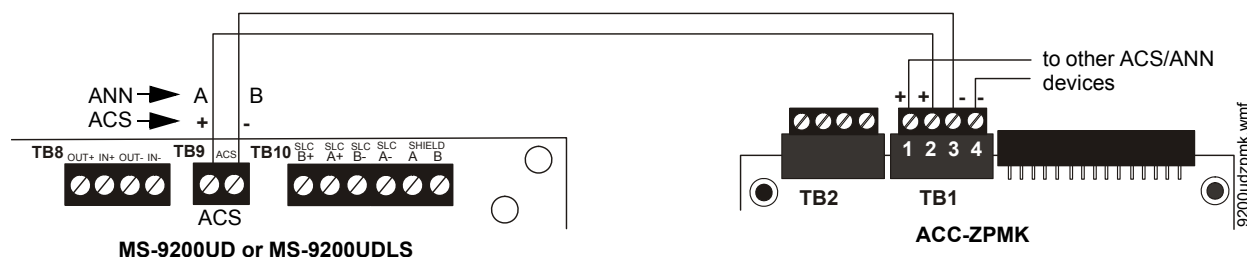

Figure D.2 Connection for MS-9200UD or MS-9200UDLS to ACC-ZPMK

D.1.4 ACC-25/50ZS and ACC-25/50ZST Switch Settings

ACC-ZPMK DIP Switch S1

- Switches 1, 2, and 3 are used to configure the ACC-25/50ZS and ACC-25/50ZST for operation with a specific FACP as shown in the following table:

SWITCH 1	SWITCH 2	SWITCH 3	CONFIGURED FOR OPERATION WITH FOLLOWING FIRE ALARM CONTROL PANEL
OFF	OFF	OFF	MS-9200UD version 1
OFF	ON	ON	ACS Protocol: MS-9600 version 1
ON	OFF	OFF	ACS Protocol: MS-9600 version 2 or higher
ON	OFF	ON	ACS Protocol: MS-9200UDLS or MS-9200UD version 2 or higher
ON	ON	OFF	ANN-BUS Protocol: MS-9600LS Version 4 or higher MS-9200UDLS Version 4 or higher

Table D.2 FACP Configuration

- Switch 4 - future use
- Switches 5, 6, 7, and 8 - used to set the number of ACC-25/50DAZS panels installed.

S1 DIP Switch	ON	OFF
5	not used (must be set to OFF)	
6	This switch works in conjunction with switches 7 & 8 to set the number of ACC-25/50DAZS panels connected	
7	This switch works in conjunction with switches 6 & 8 to set the number of ACC-25/50DAZS panels connected	
8	6 OFF, 7 OFF, 8 OFF = No ACC-25/50DAZS Distributed Audio Panels connected to ACC-25/50ZS/T 6 OFF, 7 OFF, 8 ON = 1 ACC-25/50DAZS Distributed Audio Panel connected to ACC-25/50ZS/T 6 OFF, 7 ON, 8 OFF = 2 ACC-25/50DAZS Distributed Audio Panels connected to ACC-25/50ZS/T 6 OFF, 7 ON, 8 ON = 3 ACC-25/50DAZS Distributed Audio Panels connected to ACC-25/50ZS/T 6 ON, 7 OFF, 8 OFF = 4 ACC-25/50DAZS Distributed Audio Panels connected to ACC-25/50ZS/T 6 ON, 7 OFF, 8 ON = 5 ACC-25/50DAZS Distributed Audio Panels connected to ACC-25/50ZS/T	

Table D.3 Number of ACC-25/50DAZS Panels Installed

ACC-ZPMK Rotary Address Switches S2 and S3

ACS Protocol:

The address switches must be set to ACS address 01 to communicate with the FACP. Any other ACS devices which are set to address 01 should be in Receive Mode only.

- S2=1
- S3=0

ANN-BUS Protocol:

The address switches can be set to any address between 01 through 08 to communicate with the FACP. Any other ANN-BUS devices must be set to a different address.

- S2=1-8
- S3=0

ACC-ZSM Zone Splitter Module Switch Settings

See “ACC-ZSM Zone Splitter Module (ACC-25/50ZS & ACC-25/50ZST)” on page 41 for information on setting these switches.

ACC-FFT Fire Fighter Module Switch Setting (ACC-25/50ZST only)

See Section “SW1 - Remote Microphone Installed Switch on ACC-FFT” on page 39 for additional information.

D.1.5 FACP Programming

The MS-9600, MS-9200UDLS, and MS-9200UD FACP's must be programmed to operate with the ACC-25/50ZS or ACC-25/50ZST Audio Control Center. The following table summarizes the steps involved in programming the FACP's. A detailed description of each step follows the table.

1. Enable the ACS or ANN-BUS annunciator at FACP	refer to FACP manual Option Module Programming
2. Assign zone(s) to each addressable device	refer to FACP manual Point Programming
3. Program message to be generated over each speaker circuit	refer to Message Assignment in following section
4. Activate individual devices to ensure proper programming	compare to desired programming

Table D.4 FACP Programming Steps

ACS Annunciator

The ACC-25/50ZS and ACC-25/50ZST communicate with the FACP via the ACS link. Enable the ACS Annunciator address *01* as described in the appropriate FACP manual. For ACC-25/50ZST using annunciation of remote FFTs, enable address *05* for the MS-9200UDLS and address *07* for the MS-9600. The ACS programming options can be accessed by entering Programming Mode and selecting Option Modules from the list of programming options.

ANN-BUS Annunciator

The ACC-25/50ZS and ACC-25/50ZST communicate with the FACP via the ANN-BUS link. Auto-configure the ANN-BUS Annunciator as described in the appropriate FACP manual. The ANN-BUS programming options can be accessed by entering Programming Mode and selecting Option Modules from the list of programming options.

Zone Assignment

Zones must be assigned to each addressable input device in order to activate the appropriate output device(s). Program each device to a zone as described in the appropriate FACP manual. Device programming can be accessed by entering Programming Mode and selecting Point Program from the list of programming options.

Note that when the ACS/ANN-BUS Annunciator option is enabled at the FACP, speaker circuits at the ACC-25/50ZS or ACC-25/50ZST are automatically assigned dedicated zone numbers. These zone numbers can then be programmed to addressable input devices which will allow the input device to activate the programmed speaker zone.

The following table lists the zone numbers that are automatically assigned to each speaker circuit. Note that the ACC-ZSM Zone Splitter Module installed in the ACC-25/50ZS or ACC-25/50ZST provides 8 Style Y (Class B) speaker circuits. Additional speaker circuits can be added using the ACC-25/50DAZS.

Speaker Circuit Number	Zone Number
All Speaker Circuits (1-24)	32
1 (on ACC-25/50ZS/T)	33
2 (on ACC-25/50ZS/T)	34
3 (on ACC-25/50ZS/T)	35
4 (on ACC-25/50ZS/T)	36
5 (on ACC-25/50ZS/T)	37
6 (on ACC-25/50ZS/T)	38
7 (on ACC-25/50ZS/T)	39
8 (on ACC-25/50ZS/T)	40

Table D.5 Speaker Circuit Zone Assignments

9 (on 1st ACC-25/50DAZS)	41
10 (on 1st ACC-25/50DAZS)	42
11 (on 1st ACC-25/50DAZS)	43
12 (on 1st ACC-25/50DAZS)	44
13 (on 1st ACC-25/50DAZS)	45
14 (on 1st ACC-25/50DAZS)	46
15 (on 1st ACC-25/50DAZS)	47
16 (on 1st ACC-25/50DAZS)	48
17 (on 2nd ACC-25/50DAZS)	49
18 (on 2nd ACC-25/50DAZS)	50
19 (on 2nd ACC-25/50DAZS)	51
20 (on 2nd ACC-25/50DAZS)	52
21 (on 2nd ACC-25/50DAZS)	53
22 (on 2nd ACC-25/50DAZS)	54
23 (on 2nd ACC-25/50DAZS)	55
24 (on 2nd ACC-25/50DAZS)	56

Table D.5 Speaker Circuit Zone Assignments

Note that Zone 32 is assigned to all speaker circuits. If an addressable device programmed to Zone 32 is activated, the message programmed to Zone 32 will be generated to **all** speaker circuits. The exception is when one or more devices programmed to Zones 33 through 40 is also activated. If the newly activated zone is programmed to a message with a higher priority than Zone 32, the higher priority message will be generated to all circuits.

IMPORTANT! Messages have a priority scheme with Message 1 having the highest priority and Message 5 having the lowest priority. For example, If an addressable device activates a speaker circuit programmed to generate Message 5, that message will be generated over the selected speaker zone. If later, another device activates a speaker circuit programmed to generate Message 3, Message 3 has a higher priority than Message 5 and will therefore be generated over both activated speaker zones. The highest priority message will always be generated over all activated speaker circuits.

Programming Tips for MS-9600, MS-9600LD, MS-9200UDLS, and MS-9200UD

It is important to note that Message 1 is assigned to Zone 00 (General Alarm) as a default. A message, however, will not be generated over the speaker circuits unless one of the following programming steps is completed:

- For General Alarm applications, all input points must have an audio zone assigned to it:
 - ✓ Z32 to activate all audio zones
 - OR**
 - ✓ Z33 to Z56 for specific audio zone control
- For non-General Alarm applications where input devices and/or messages are mapped to specific zones, Message 1 must be removed from Zone 00 programming.

Message Assignment - Speaker Specific

The ACC-25/50ZS and ACC-25/50ZST have the capability of generating up to five different messages. Any one of the five messages can be programmed to each of the speaker circuit Zones 32 through 56. For example:

- if an addressable device programmed to Zone 35 is activated and no other devices are active, the message programmed for Zone 35 will be generated over speaker circuit 3 on the ACC-25/50ZS or ACC-25/50ZST. (Refer to Table D.5 on page 109).

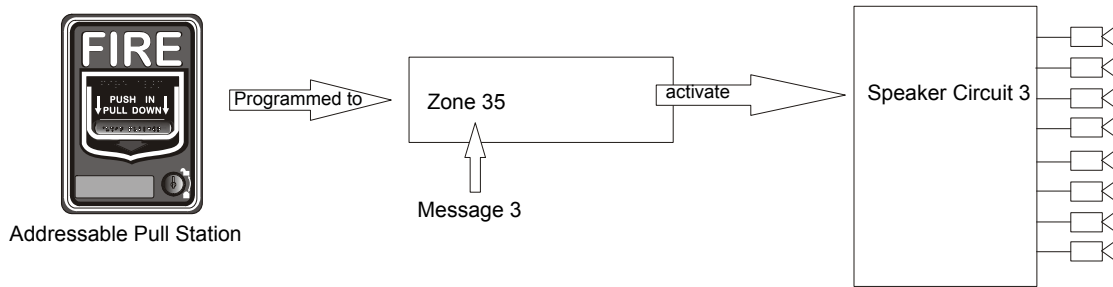

- if an addressable device (address 09 in example below) programmed to Zone 35 is activated and a second addressable device (address 15 in example below) programmed to Zone 36 is activated, the highest priority message programmed to either Zone 35 or Zone 36 (Message 3 in example below) will be generated over speaker circuits 3 and 4. (Table D.5 on page 109). If an addressable device (address 21 in example below) programmed to Zone 32 is then activated, the highest priority message programmed to Zone 32, 35, or 36 (Message 1 in example below) will be generated over all speaker circuits. (Table D.5 on page 109).

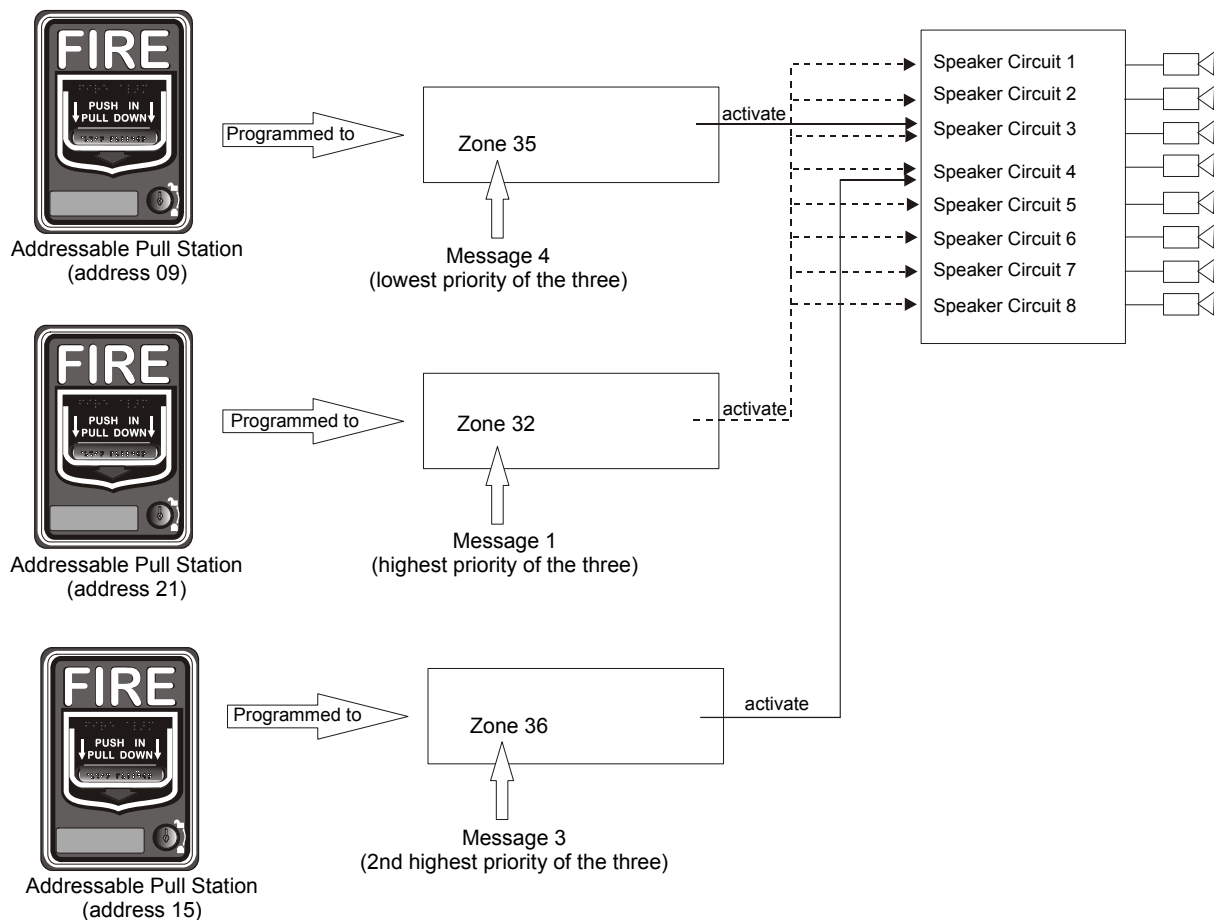

Message Assignment - Zone Specific

The FACP can be programmed to allow a specific addressable input device to generate one of five messages over any speaker circuit. Any one of the five messages can be programmed to each of the available zones (Zone 1 through Zone 99). In the following examples, assume that Zone 5 is programmed to Message 1, Zone 7 is programmed to Message 2, Zone 8 is programmed to Message 3, and Zone 35 is not programmed to a message.

- if two devices are being programmed and the *first* addressable input device is programmed to Zone 7 and Zone 35, and a *second* addressable input device is programmed to Zone 5 and Zone 35, activation of the first addressable input device (address 12 in the example below) will cause Message 2 to be generated over speaker circuit 3. (Table D.5 on page 109). If the second addressable device (address 20 in the example below) is also activated, Message 1 will now be transmitted over speaker circuit 3 since Message 1 has a higher priority than Message 2.

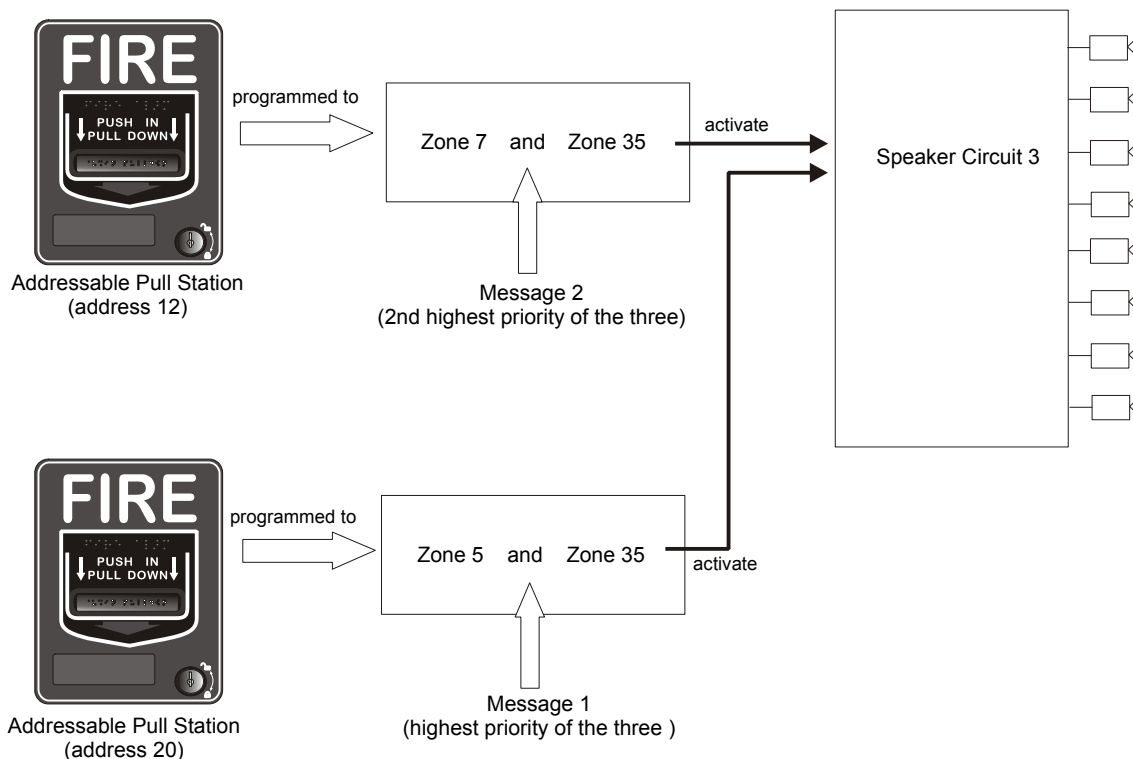

Programming is accomplished in the same manner as previously described.

To Program one of five messages to a speaker zone, press the *ENTER* key at the FACP. The following screen will be displayed:

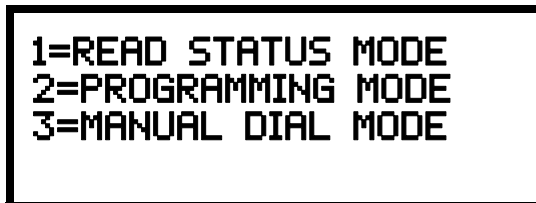

Access Programming Mode by pressing the 2 key. The following screen will be displayed:



Entering the **Master** level password (default 00000) will cause the following screen to appear:



Select the *Zone Setup* option by pressing 3. The following screens will be displayed.



Zone Setup Screen #1



Zone Setup Screen #2



Zone Setup Screen #3

Pressing 3 while viewing Zone Setup Screen #3 will cause the following screen to be displayed:



Press the down arrow key until the following screen is displayed.



The default setting is *No Message* for each speaker circuit. In the screen shown above, Z32 is the zone dedicated for all speaker circuits. To change from No Message, press 3 to display the following screens:

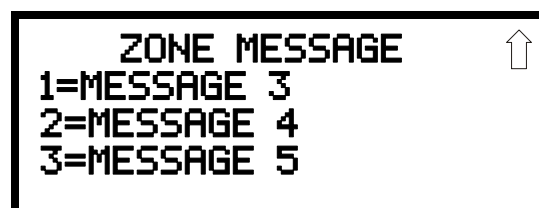

Select the message (Message 1 through Message 5) by pressing the number corresponding to the desired message. After the selection is made, the display will return to the screen displaying Z32 which will have changed from No Message to the selected message.

Repeat the procedure outlined above for each speaker zone (Z32 through Z56) and then exit Programming by pressing the Escape (ESC) key to save the programming changes. Test the system to ensure proper operation.

Fire Fighter Telephone SLC Point Assignment

If annunciation of remote FFT locations is desired on the ACC-FFT keypad, an addressable input device must be programmed as a **PHONE** type on the MS-9200UDLS or MS-9600.

Program each addressable input device as a **PHONE** type as described in the appropriate FACP manual. SLC point programming can be accessed by entering Programming Mode and selecting Point Program from the list of programming options.

The following table lists the SLC points dedicated for FFT annunciation:

FFT Number on ACC-FFT Keypad	MS-9200UDLS SLC Point Number (ACS Address 05)	MS-9600 SLC Point Number (ACS Address 07) <i>FFT Inputs can be installed <u>only</u> on SLC Loop #1</i>
1	75	135
2	76	136
3	77	137
4	78	138
5	79	139
6	80	140
7	81	141
8	82	142
9	83	143
10	84	144
11	85	145
12	86	146
13	87	147
14	88	148
15	89	149
16	90	150
17	91	151
18	92	152
19	93	153
20	94	154
21	95	155
22	96	156
23	97	157
24	98	158

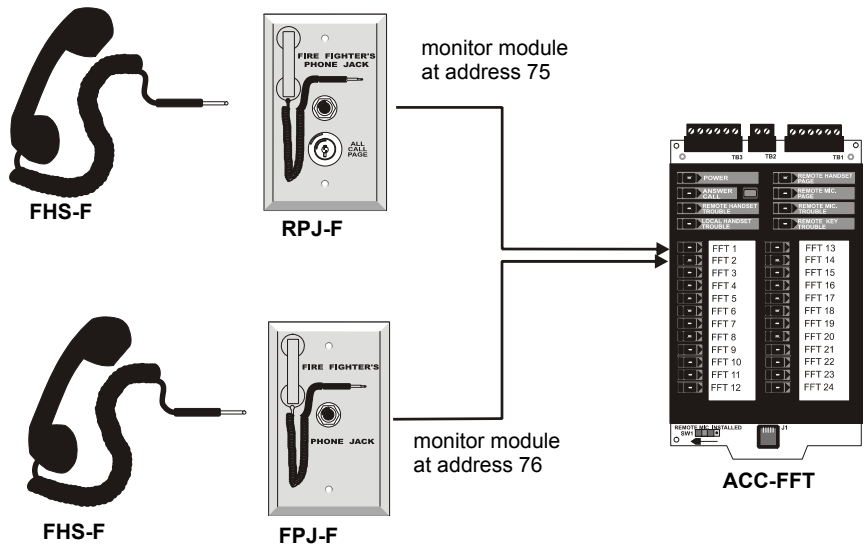

To Program a monitor module in an FPJ-F or RPJ-F, press the *ENTER* key at the FACP. The following screen will be displayed:

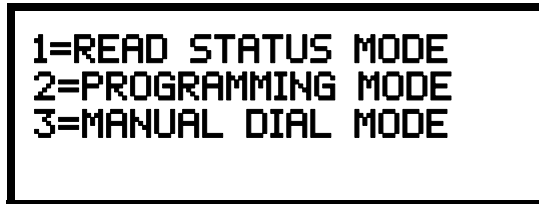

Access Programming Mode by pressing the 2 key. The following screen will be displayed:



Entering the ***Master*** level password (default 00000) will cause the following screen to appear:



PROGRAMMING
1=AUTOPROGRAM
2=POINT PROGRAM
3=ZONE SETUP

A downward-pointing arrow is located in the top right corner of the screen.

Access Point Programming by pressing the 2 key. The following screen will be displayed:

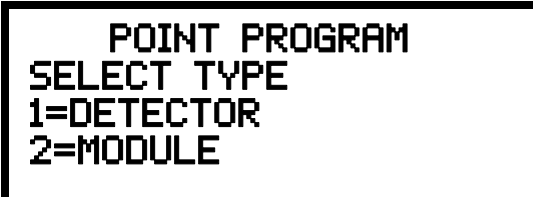

POINT PROGRAM
SELECT TYPE
1=DETECTOR
2=MODULE

Press the 2 key to alter the programming of an addressable module:



MODULES
1=ADD
2=DELETE
3=EDIT

Press the 3 key to edit the programming:



NORMAL MONITOR

2000
W 1M075

A downward-pointing arrow is located in the top right corner of the screen.

Press down arrow key once:

```

EDIT MONITOR
1=ENABLED
2=TYPE MONITOR
  
```

Press 2 to edit the type, then press the down arrow key six times:

```

1=PHONE
2=USER-DEFINED-10
3=TAMPER
  
```



Press 1 to select PHONE type.

Repeat the above steps for each remaining RPJ-F or FPJ-F location.

D.2 MS-5210UD

Refer to the MS-5210UD manual, Document #50193, for panel specific information. The ACC-25/50ZS and ACC-25/50ZST can be automatically triggered by the MS-5210UD to transmit one of five messages over selected speaker circuits. This is accomplished by zone and relay programming at the MS-5210UD, DIP switch programming in the ACC-25/50ZS or ACC-25/50ZST and various wiring schemes.

Important! When installing/configuring the MS-5210UD zones for ACS control of the ACC-25/50ZS/T, NON-FIRE types should not be assigned to any ACC-25/50ZS/T audio zone(s) unless the NON-FIRE programmed relay is controlling at least one of the CMD inputs of the ACC-25/50ZS/T.

D.2.1 Overview

The ACC-25/50ZS and ACC-25/50ZST provide 8 speaker circuits standard via the ACC-ZSM Zone Splitter Module. Expansion to 24 speaker circuits is possible by adding ACC-25/50DAZS panels. The ACC-25/50ZS and ACC-25/50ZST have the ability to generate and direct one of five messages to specific speaker circuits.

D.2.2 MS-5210UD Individual Zone Control With One or Two Messages

In this configuration, the MS-5210UD provides automatic, individual audio zone (1 through 8) control of the ACC-25/50ZS or ACC-25/50ZST via the ACS serial link. The optional LED-10IM must be installed and enabled in the MS-5210UD programming. The Relay Closure outputs of the MS-5210UD are used to trigger Message #1 (Fire Evacuation) and Message #2 (Chemical Spill) on the ACC-25/50ZS or ACC-25/50ZST via the CMD1 and CMD2 inputs.

If only the generating Fire Evacuation announcement (Message #1) to individual audio zones is desired, do not connect the MS-5210UD Relay outputs to the ACC-25/50ZS or ACC-25/50ZST CMD inputs. In this case, the activation of the audio zones via the ACS link will automatically trip the Fire Evacuation message to the ACS link selected zone.

Manually deactivating a speaker circuit is accomplished by pressing the activated zone push-button on the ACC-ZPMK keypad. Manual activation of the audio system can be performed by selecting zone push-buttons(s) on the ACC-ZPMK and then pressing either of the Message buttons. All-Call Paging is possible by first pressing the All-Call push-button on the ACC-25/50ZS or ACC-25/50ZST main keypad and then pressing the push-to-talk switch on the microphone.

All faults on the ACC-25/50ZS or ACC-25/50ZST are sent upstream via the ACS link to the MS-5210UD and are indicated by illuminating the System Trouble LED on the MS-5210UD.

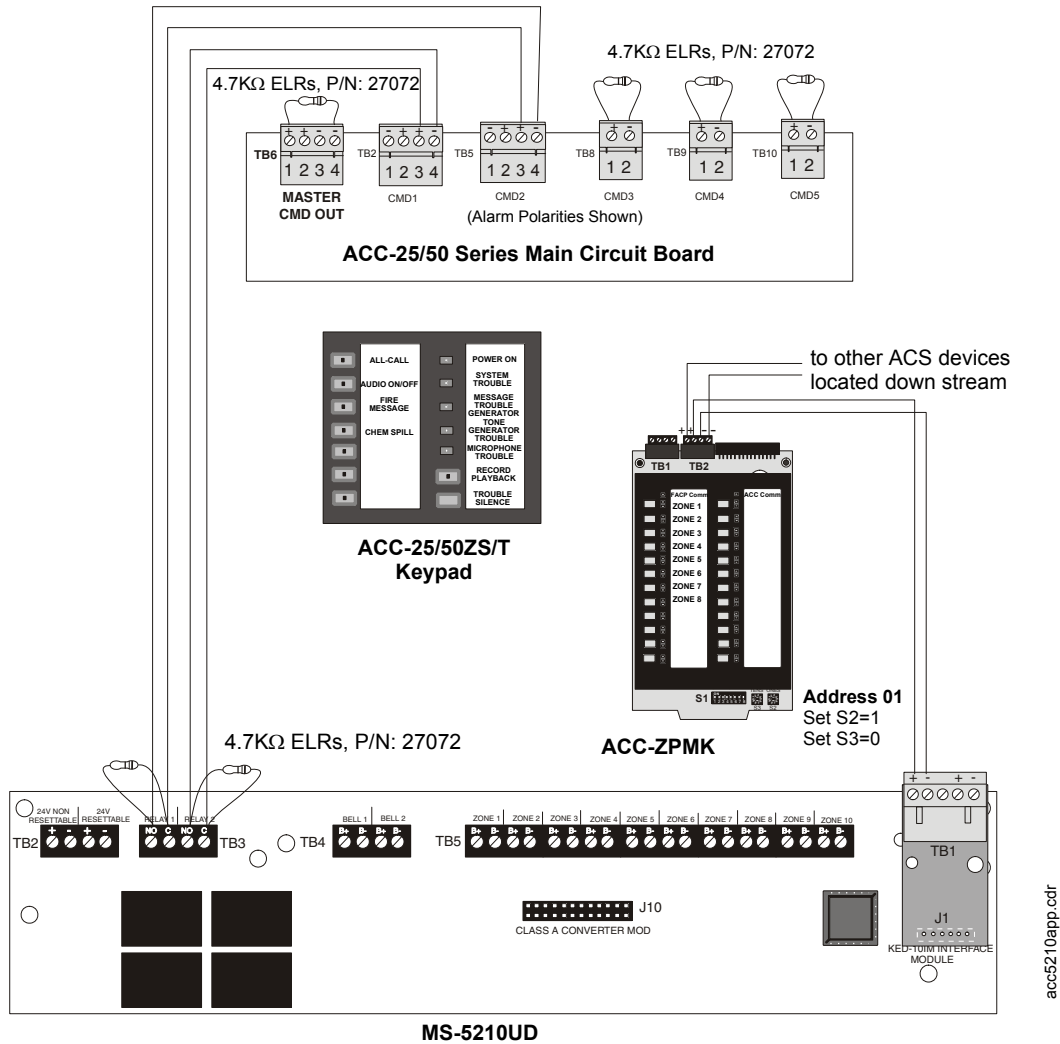

Figure D.3 MS-5210UD Connection to ACC-25/50ZS or ACC-25/50ZST

ACC-25/50ZS/T DIP Switch Settings

ACC-ZPMK Zone Page Module DIP switch S1:

- Switches 1, 2, and 3 are set to OFF, OFF, ON for ACS link operation with the MS-5210UD FACP
- Switch 4 (future use) is set to OFF
- Switch 5, 6, and 7 are set to OFF

ACC-ZPMK Zone Page Module Rotary switches S2 and S3

- S2 = 0
- S3 = 1

ACC-ZSM Zone Splitter Module Switch Settings [refer to Section “ACC-ZSM Zone Splitter Module (ACC-25/50ZS & ACC-25/50ZST)” on page 41 for additional information].

ACC-25/50ZS/T Main Board DIP switch S3

The following DIP Switches can be set to any value except 1, 2, 3 = OFF, OFF, OFF.

- Switches 1, 2, and 3 are set to ON, OFF, OFF for Single Zone output and the selection of two messages (Fire Evacuation and Chemical Spill)

MS-5210UD Programming

- Assign functions to Zones 1 through 8.
- Enable the LED-10IM EIA-485 Interface Module.
- Configure Programmable Relay #1 for alarm activation (Fire Evacuation), if desired.
- Configure Programmable Relay #2 for supervisory (Chemical Spill), if desired.

D.2.3 MS-5210UD All Zone Activation With One to Five Messages

In this configuration, the MS-5210UD provides automatic control of the five messages using the CMD inputs on the ACC-25/50ZS/T via the ACM-8RF on ACS serial link. Activation of any one of the CMD inputs directs the corresponding voice message to all audio zones.

The optional LED-10IM must be installed and enabled in the MS-5210UD programming. Locate the ACM-8RF per installation instructions, make wiring connections to the LED-10IM and connect the relay outputs to the CMD inputs of the ACC-25/50ZS/T.

Manually deactivating a speaker circuit is accomplished by pressing the activated zone push-button on the ACC-ZPMK keypad. Manual activation of the audio system can be performed by selecting zone push-button(s) on the ACC-ZPMK and then pressing either of the Message buttons. All-Call Paging is possible by first pressing the All-Call push-button on the ACC-25/50ZS/T main keypad and then pressing the push-to-talk switch on the microphone.



NOTE: The ACC-ZPMK Zone Page Module is not connected via the ACS link to the MS-5210UD.

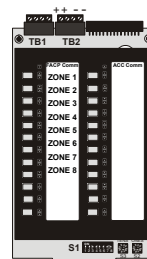
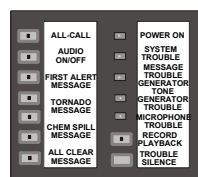
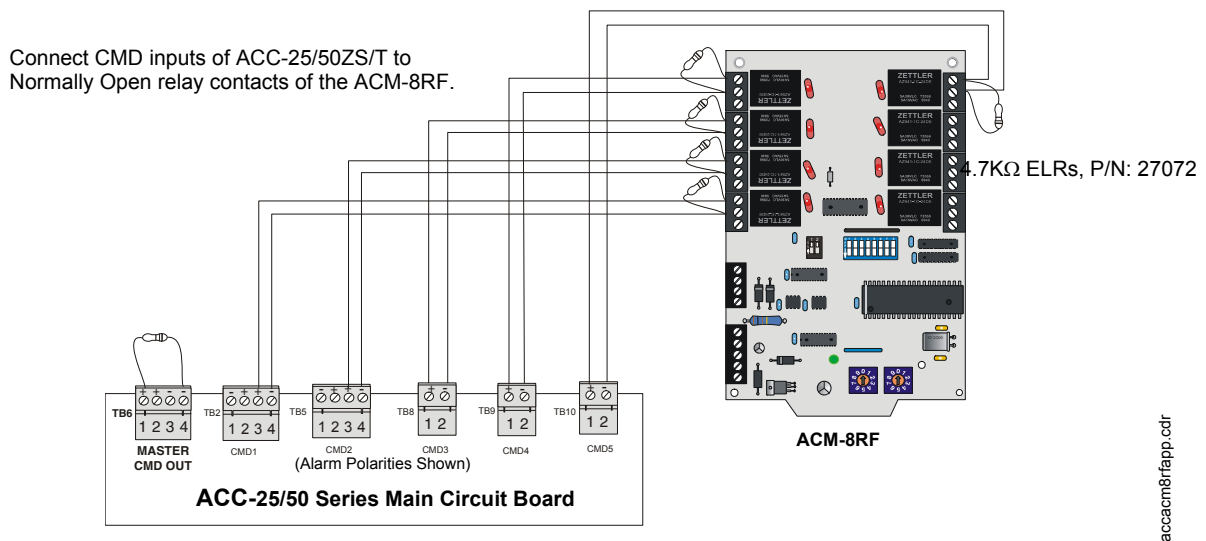

Figure D.4 ACC-25/50ZS/T Connection to ACM-8RF

ACC-25/50ZS and ACC-25/50ZST Switch Settings

ACC-ZPMK Zone Page Module DIP Switch S1

- Switches 1, 2, and 3 are set to OFF, OFF, OFF for No ACS link operation
- Switch 4 (future use) is set to OFF
- Switches 5, 6, 7, and 8 are set to OFF

ACC-ZSM Zone Splitter Module Switch Settings (refer to Section “ACC-ZSM Zone Splitter Module (ACC-25/50ZS & ACC-25/50ZST)” on page 41 for additional information).

ACC-25/50ZS/T Main Board DIP Switch S3

The following DIP Switches can be set to any value except 1, 2, 3 = OFF, OFF, OFF.

- Switches 1, 2, and 3 are set to ON, OFF, ON for Single Zone output and the selection of five messages

ACM-8RF Programming

- Set rotary switch on ACM-8RF for ACS address 1
- Assign SW3 DIP Switch settings per MS-5210UD manual

MS-5210UD Programming

- Assign functions (alarm, supervisory, etc.) to Zones 1 through 5 for voice message control.
- Enable the LED-10IM EIA-485 Interface Module.

D.3 MS-9200(E)

The ACC-25/50ZS and ACC-25/50ZST can be automatically triggered via the ACS serial link by the MS-9200(E) to transmit one of five messages over selected speaker zones. This is accomplished by zone programming at the FACP.

D.3.1 Overview

The ACC-25/50ZS and ACC-25/50ZST provide 8 speaker circuits standard via the ACC-ZSM Zone Splitter Module. Future development will allow expansion to 24 speaker circuits. The ACC-25/50ZS and ACC-25/50ZST also has the ability to generate and direct one of five messages to specific speaker zones.

The MS-9200(E) communicates with the ACC-25/50ZS/T over the ACS annunciator terminals. The Annunciator option must therefore be enabled in the FACP programming. When this option is enabled, FACP zones Z33 through Z56 are dedicated as output zones for speaker circuits 1 through 8 (plus 9 through 24 on ACC-25/50DAZS panels) respectively. FACP Zone 32 is dedicated to turn on all speaker circuits. The FACP will then allow the installer to program individual addressable devices to any of the speaker zones using the Point program option. Message 1, which is generated by the ACC-25/50ZS/T, will be directed to each activated speaker circuit.

All faults on the ACC-25/50ZS/T are sent upstream via the ACS link to the MS-9200(E) and are indicated as an *ACS Fault* on the display.

When audio annunciation of NON-FIRE events is required, assign NON-FIRE type modules to audio zone(s) and a control module to the same audio zone(s). The control module should be used to control a CMD input of the ACC-25/50ZS/T.

Important: *The message repeat setting on the ACC-25/50ZS/T should be set to infinite. This will ensure that lower priority activated zones will continue to broadcast the voice message.*

D.3.2 Basic MS-9200 & ACC-25/50ZS/T Step-By-Step Install/Setup

Example #1 - Individual Audio zone control and individual control of all voice messages:

In this example, the MS-9200 can route the selected voice message (1-5) to activated audio zones. Zone programming in the FACP is used to map the appropriate audio zone (32-56) and activate the CMD input on the audio panel via the SLC:

1. Connect ACS wiring from FACP to ACC-25/50ZS/T.
2. Set ACS Address wheels on ACC-ZPMK for address 01.
3. Connect CMD inputs of the ACC-25/50ZS/T to modules on the SLC loop of the MS-9200 FACP.
4. Set DIP switches 1, 2, and 3 on Switch S1 of the ACC-ZPMK for operation with the MS-9200 FACP.
5. Set DIP switches 6, 7, and 8 on Switch S1 of the ACC-ZPMK for the number of ACC-25/50DAZS panels installed.
6. Set Switch SW1 on the ACC-ZSM for one or two Audio Amplifier (ACC-AAM25) configuration.
7. Set Switch SW2 on the ACC-ZSM for Style Y (Class B) or Style Z (Class A) speaker circuit wiring.
8. Set DIP switches 1, 2, and 3 on Switch S3 of the ACC-25/50ZS/T motherboard for Single Zone with activation of 2-5 messages.
9. Record any new messages into the ACC-25/50ZS/T.
10. Enable ACS communication and program zones (32-56) in the MS-9200 FACP.
11. Program modules on the SLC loop for CMD input activation.

Example #2 - Individual Audio zone control and only the Fire Evacuation voice message:

In this example, the MS-9200 can route the Fire Evacuation message (message #1) to the activated audio zones via zone programming. The CMD inputs are not used to activate the audio panel. The audio panel defaults to activating the Fire Evacuation voice message.

1. Connect ACS wiring from FACP to ACC-25/50ZS/T.
2. Set ACS Address wheels on ACC-ZPMK for address *01*.
3. Set DIP switches 1, 2, and 3 on Switch S1 of the ACC-ZPMK for operation with the MS-9200 FACP.
4. Set DIP switches 6, 7, and 8 on Switch S1 of the ACC-ZPMK for the number of ACC-25/50DAZS panels installed.
5. Set Switch SW1 on the ACC-ZSM for one or two Audio Amplifier (ACC-AAM25) configuration.
6. Set Switch SW2 on the ACC-ZSM for Style Y (Class B) or Style Z (Class A) speaker circuit wiring.
7. Set DIP switches 1, 2, and 3 on Switch S3 of the ACC-25/50ZS/T motherboard for Single Zone with activation of 2 messages (the second message will not be used).
8. Record a new Fire Evacuation message for message #1, if desired.
9. Enable ACS communication and program zones (32-56) in the MS-9200 FACP,

Example #3 - Simultaneous activation of all audio zones with individual control of all voice messages:

In this example, the MS-9200 simultaneously activates all the audio zones with one of the selected voice messages. No ACS connection is required and CMD inputs are controlled by modules on the SLC loop. Upon activation of a CMD input, the audio panel defaults to activating all of the audio circuits.

1. Connect CMD inputs of the ACC-25/50ZS/T to modules on the SLC loop of the MS-9200 FACP.
2. Set DIP switches 1, 2, and 3 on Switch S1 of the ACC-ZPMK for operation with *Non-ACS FACP*.
3. Set DIP switches 6, 7, and 8 on Switch S1 of the ACC-ZPMK for the number of ACC-25/50DAZS panels installed.
4. Set Switch SW1 on the ACC-ZSM for one or two Audio Amplifier (ACC-AAM25) configuration.
5. Set Switch SW2 on the ACC-ZSM for Style Y (Class B) or Style Z (Class A) speaker circuit wiring.
6. Set DIP switches 1, 2, and 3 on Switch S3 of the ACC-25/50ZS/T motherboard for Single Zone with activation of 2-5 messages.
7. Record any new messages into the ACC-25/50ZS/T.
8. Program modules on the SLC loop for CMD input activation.

D.3.3 Wiring From ACC-25/50ZS or ACC-25/50ZST to MS-9200(E)

The MS-9200(E) FACP communicates with the ACC-25/50ZS or ACC-25/50ZST over the ACS annunciator link. Wiring must be connected between the ACS Terminal TB5 on the MS-9200(E) and ACS Terminal TB1 on the ACC-ZPMK Zone Page Module installed on the ACC-25/50ZS/T panel.

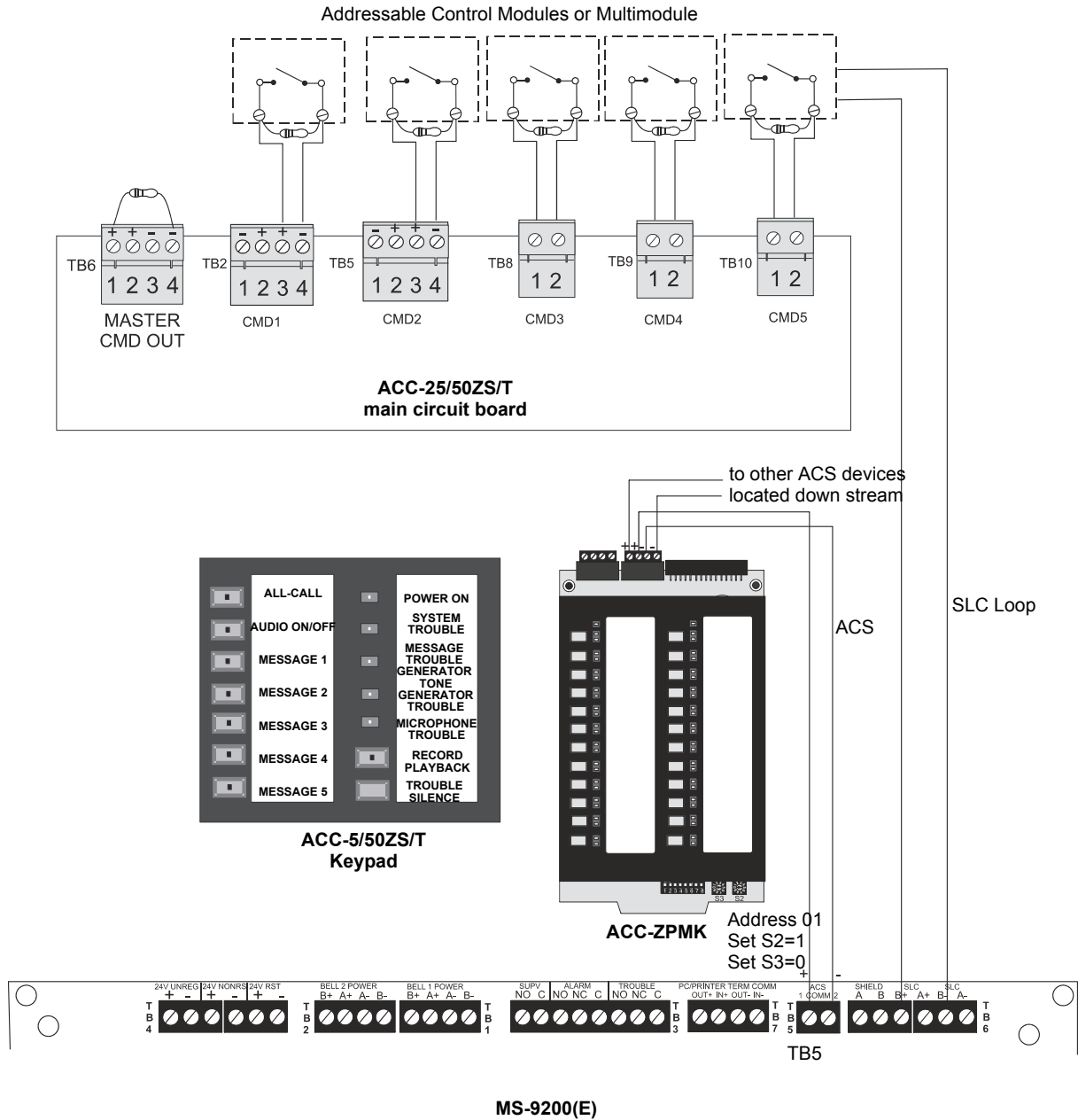

Figure D.5 ACS Connection for MS-9200(E) to ACC-ZPMK

ACC-25/50ZS & ACC-25/50ZST Switch Settings

ACC-ZPMK DIP Switch S1

- Switches 1, 2, and 3 are used to configure the ACC-25/50ZS/T for operation with a specific FACP (See Table 2.4 on page 35.)
- Switch 4 - future use
- Switches 5, 6, 7, and 8 - used to set the number of ACC-25/50DAZS panels installed (See Table 2.4 on page 35.)

ACC-ZPMK Rotary Address Switches S2 and S3

The address switches must be set to ACS address *01* to communicate with the FACP. Any other ACS devices which are set to address 01 should be in Receive Mode only.

- S2=1
- S3=0

ACC-ZSM Zone Splitter Module Switch Settings

See “ACC-ZSM Zone Splitter Module (ACC-25/50ZS & ACC-25/50ZST)” on page 41 for information on setting these switches.

D.3.4 FACP Programming

The MS-9200(E) must be programmed to operate with the ACC-25/50ZS/T Audio Command Center. The following table summarizes the steps involved in programming the FACP.

Enable the ACS annunciator at FACP	refer to FACP manual Option Module Programming
Assign zones to each addressable device	refer to FACP manual Point Programming
Activate individual devices to ensure proper programming	compare to desired programming

Table D.6 FACP Programming Steps

ACS Annunciator

The ACC-25/50ZS/T communicates with the FACP via the ACS link. Enable the ACS Annunciator as described in the MS-9200(E) manual. The ACS programming options can be accessed by entering Programming Mode and selecting option *3=SYS* from the list of programming options.

Zone Assignment

Zones must be assigned to each addressable input device in order to activate the appropriate output device(s). Program each device to a zone as described in the appropriate FACP manual. Device programming can be accessed by entering Programming Mode and selecting option *2=ZONE* from the list of programming options.

Note that when the ACS Annunciator option is enabled at the FACP, speaker circuits at the ACC-25/50ZS/T are automatically assigned dedicated zone numbers (32 through 56). These zone numbers can then be programmed to addressable input devices which will allow the input device to activate the programmed speaker zone.

The following table lists the zone numbers that are automatically assigned to each speaker circuit. Note that the ACC-ZSM Zone Splitter Module installed in the ACC-25/50ZST and each ACC-25/50DAZS provides 8 Style Y (Class B) speaker circuits.

Speaker Circuit Number	Zone Number
All Speaker Circuits (1-24)	32
1 (on ACC-25/50ZS/T)	33
2 (on ACC-25/50ZS/T)	34
3 (on ACC-25/50ZS/T)	35
4 (on ACC-25/50ZS/T)	36
5 (on ACC-25/50ZS/T)	37
6 (on ACC-25/50ZS/T)	38
7 (on ACC-25/50ZS/T)	39
8 (on ACC-25/50ZS/T)	40
9 (on 1st ACC-25/50DAZS)	41
10 (on 1st ACC-25/50DAZS)	42
11 (on 1st ACC-25/50DAZS)	43
12 (on 1st ACC-25/50DAZS)	44
13 (on 1st ACC-25/50DAZS)	45
14 (on 1st ACC-25/50DAZS)	46
15 (on 1st ACC-25/50DAZS)	47
16 (on 1st ACC-25/50DAZS)	48
17 (on 2nd ACC-25/50DAZS)	49
18 (on 2nd ACC-25/50DAZS)	50
19 (on 2nd ACC-25/50DAZS)	51
20 (on 2nd ACC-25/50DAZS)	52
21 (on 2nd ACC-25/50DAZS)	53
22 (on 2nd ACC-25/50DAZS)	54
23 (on 2nd ACC-25/50DAZS)	55
24 (on 2nd ACC-25/50DAZS)	56

Table D.7 Speaker Circuit Zone Assignments

Note that Zone 32 is assigned to all speaker circuits. If an addressable device programmed to Zone 32 is activated, the message will be generated to **all** speaker circuits. The exception is when one or more devices programmed to Zones 33 through 40 is also activated and an addressable control module is used to activate one of the CMD inputs on the ACC-25/50ZS/T. If the newly activated zone is programmed to activate a message with a higher priority than Zone 32, the higher priority message will be generated to all circuits.

IMPORTANT! Messages have a priority scheme with Message 1 having the highest priority and Message 5 having the lowest priority. The highest priority message will always be generated over all activated speaker circuits.

D.4 MS-5UD-3/7 and MS-10UD-3/7

The ACC-25/50ZS and ACC-25/50ZST can be automatically triggered via the ANN-BUS serial link by the MS-5UD-3/7 or MS-10UD-3/7 (version 2 or higher), to transmit one of five messages over selected speaker circuits. This is accomplished by zone programming at the FACP.

D.4.1 Overview

The ACC-25/50ZS and ACC-25/50ZST provide 8 speaker circuits standard via the ACC-ZSM Zone Splitter Module. Expansion to 24 speaker circuits is possible by adding ACC-25/50DAZS panels. The ACC-25/50ZS and ACC-25/50ZST also have the ability to generate and direct one of five messages to specific speaker circuits.

The FACP's communicate with the ACC-25/50ZS and ACC-25/50ZST over the ANN-BUS terminals using the ANN-BUS protocol only.

When configuring the ACC-25/50ZS/T for use on the ANN-BUS serial link, the ACC-ZPMK's address wheels can be set to any address between 1 through 8 and enabled in the FACP programming. When this option is enabled, FACP input zones 1 through 5 on the five zone panel correspond to speaker circuits 1 through 5 on the ACC-25/50ZS/T and 1 through 10 on the ten zone panel correspond to speaker circuits 1 through 10 on the ACC-25/50ZS/T respectively. One of the input zones can be programmed to be an All-Call Zone, which will activate all speaker circuits. Any one of the five messages can be assigned to any of the input zones.

All faults on the ACC-25/50ZS and ACC-25/50ZST are sent upstream via the ANN-BUS link and are indicated as a *Voice EVAC Fault* on the display.

Important Notes:

1. For proper operation, a message must be assigned to each zone that is programmed to activate an audio speaker circuit.
2. The message repeat setting on the ACC-25/50ZS and ACC-25/50ZST should be set to infinite. This will ensure that lower priority activated zones will continue to broadcast the voice message.
3. CMD inputs are not used for activation of the ACC-25/50ZS and ACC-25/50ZST, however, 4.7K Ω ELRs must still be connected across CMD3, CMD4, and CMD5.
4. Annunciation of remote FFT (FireFighter Telephone) locations is not possible.

D.4.2 Basic ANN-BUS Step-By-Step Install/Setup

1. Connect ANN-BUS wiring from FACP to ACC-25/50ZS or ACC-25/50ZST.
2. Set Address Wheels on ACC-ZPMK to any address from 01 through 08.
3. Set DIP Switches (1 = ON, 2 = ON, and 3 = OFF) on Switch S1 of the ACC-ZPMK for operation with the FACP and switches 6, 7 and 8 for the number of ACC-25/50DAZS panels.
4. Set Switch SW1 on the ACC-ZSM for one or two Audio Amplifier (ACC-AAM25) configuration.
5. Set Switch SW2 on the ACC-ZSM for Style Y (Class B) or Style Z (Class A) speaker circuit wiring.
6. Set DIP switches 1, 2, and 3 on Switch S3 of the ACC-25/50ZS or ACC-25/50ZST motherboard for Single Zone with activation of 2-5 messages.
7. Record any new messages into the ACC-25/50ZS or ACC-25/50ZST.
8. Enable ANN-BUS communication, Auto-configure the ANN-BUS, assign messages (1-5) to input zones and assign All-Call zone (if desired) on the FACP.

D.4.3 ACC-ZPMK DIP Switch 1 Settings on ACC-25/50ZS and ACC-25/50ZST

Switches 1, 2, and 3 are used to configure the ACC-25/50ZS and ACC-25/50ZST for operation with a specific FACP. The switch settings for use with the MS-5UD-3/7 and MS-10UD-3/7 (software version 2.0 or higher) are as follows:

Switch 1	Switch 2	Switch 3	Configuration
ON	ON	OFF	MS-5UD-3/7 and MS-10UD-3/7 Version 2.0 or higher

Table D.8 MS-5UD-3/7 and MS-10UD-3/7 FACP Configuration

D.4.4 Wiring From ACC-25/50ZS or ACC-25/50ZST to FACP

The FACP communicates with the ACC-25/50ZS/T over the ACS or ANN-BUS annunciator link. Wiring must be connected between Terminal TB6 on the FACP and Terminal TB1 on the ACC-ZPMK Zone Page Module installed on the ACC-25/50ZS/T panel.

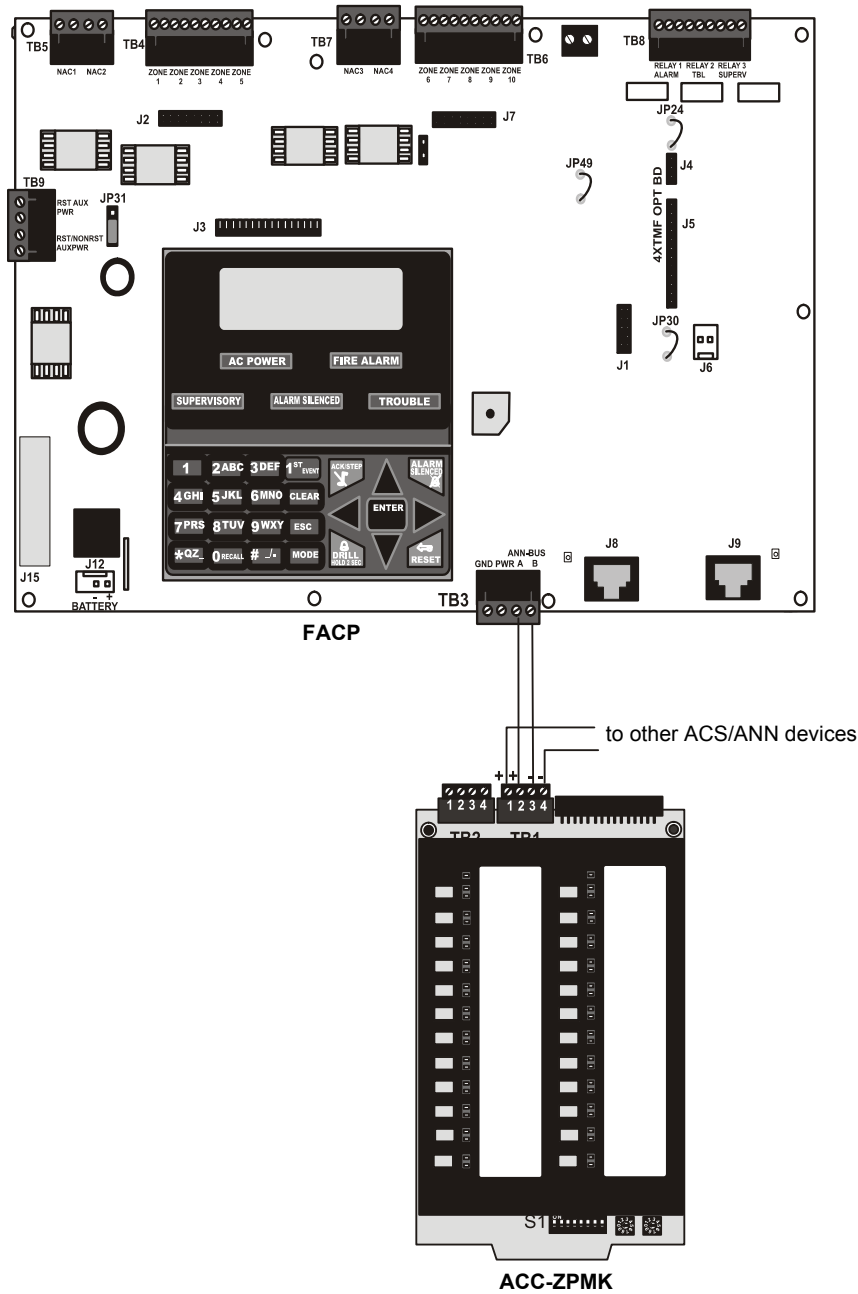

Figure D.6 Connection for MS-5UD-3/7 and MS-10UD-3/7 to ACC-ZPMK

acczpmto5x.wmf

- Switches 5, 6, 7, and 8 - used to set the number of ACC-25/50DAZS panels installed.

S1 DIP Switch	ON	OFF
5	not used (must be set to OFF)	
6	This switch works in conjunction with switches 7 & 8 to set the number of ACC-25/50DAZS panels connected	
7	This switch works in conjunction with switches 6 & 8 to set the number of ACC-25/50DAZS panels connected	
8	6 OFF, 7 OFF, 8 OFF = No ACC-25/50DAZS Distributed Audio Panels connected to ACC-25/50ZS/T 6 OFF, 7 OFF, 8 ON = 1 ACC-25/50DAZS Distributed Audio Panel connected to ACC-25/50ZS/T 6 OFF, 7 ON, 8 OFF = 2 ACC-25/50DAZS Distributed Audio Panels connected to ACC-25/50ZS/T 6 OFF, 7 ON, 8 ON = 3 ACC-25/50DAZS Distributed Audio Panels connected to ACC-25/50ZS/T 6 ON, 7 OFF, 8 OFF = 4 ACC-25/50DAZS Distributed Audio Panels connected to ACC-25/50ZS/T 6 ON, 7 OFF, 8 ON = 5 ACC-25/50DAZS Distributed Audio Panels connected to ACC-25/50ZS/T	

Table D.9 Number of ACC-25/50DAZS Panels Installed

ACC-ZPMK Rotary Address Switches S2 and S3

The address switches can be set to any address from 01 through 08 to communicate with the FACP. Any other ANN-BUS devices must be set to a different address.

- S2=1 - 8
- S3=0

ACC-ZSM Zone Splitter Module Switch Settings

See “ACC-ZSM Zone Splitter Module (ACC-25/50ZS & ACC-25/50ZST)” on page 41 for information on setting these switches.

ACC-FFT Fire Fighter Module Switch Setting (ACC-25/50ZST only)

See Section “SW1 - Remote Microphone Installed Switch on ACC-FFT” on page 39 for additional information.

D.4.5 FACP Programming

The FACP must be programmed to operate with the ACC-25/50ZS or ACC-25/50ZST Audio Command Center. The following table summarizes the steps involved in programming the FACP. A detailed description of each step follows the table.

Enable the ANN-BUS annunciator at FACP	refer to FACP manual Option Module Programming
Assign All-Call Zone (if applicable)	refer to FACP manual ANN Options Programming
Program message to be generated over each speaker circuit	refer to Message Assignment in following section
Activate individual devices to ensure proper programming	compare to desired programming

Table D.10 FACP Programming Steps

ANN-BUS Annunciator

The ACC-25/50ZS and ACC-25/50ZST communicate with the FACP via the ANN-BUS link. Auto-configure the ANN-BUS Annunciator as described in the appropriate FACP manual. The ANN-BUS programming options can be accessed by entering Programming Mode and selecting Option Modules from the list of programming options.

Zone Assignment

Zones must be assigned to each addressable input device in order to activate the appropriate output device(s). Program each device to a zone as described in the appropriate FACP manual. Device programming can be accessed by entering Programming Mode and selecting Point Program from the list of programming options.

Note that when the ANN-BUS Annunciator option is enabled at the FACP, speaker circuits at the ACC-25/50ZS or ACC-25/50ZST are automatically assigned dedicated zone numbers. These zone numbers can then be programmed to addressable input devices which will allow the input device to activate the programmed speaker zone.

The following table lists the zone numbers that are automatically assigned to each speaker circuit. Note that the ACC-ZSM Zone Splitter Module installed in the ACC-25/50ZS or ACC-25/50ZST provides 8 Style Y (Class B) speaker circuits. Additional speaker circuits can be added using the ACC-25/50DAZS.

Speaker Circuit Number	Zone Number
All Speaker Circuits (1-24)	1 - 10
1 (on ACC-25/50ZS/T)	1
2 (on ACC-25/50ZS/T)	2
3 (on ACC-25/50ZS/T)	3
4 (on ACC-25/50ZS/T)	4
5 (on ACC-25/50ZS/T)	5
6 (on ACC-25/50ZS/T)	6
7 (on ACC-25/50ZS/T)	7
8 (on ACC-25/50ZS/T)	8
9 (on 1st ACC-25/50DAZS)	9
10 (on 1st ACC-25/50DAZS)	10

Table D.11 Speaker Circuit Zone Assignments

IMPORTANT! Messages have a priority scheme with Message 1 having the highest priority and Message 5 having the lowest priority. For example, If an input zone activates a speaker circuit programmed to generate Message 5, that message will be generated over the selected speaker zone. If later, another input zone activates a speaker circuit programmed to generate Message 3, Message 3 has a higher priority than Message 5 and will therefore be generated over both activated speaker zones. The highest priority message will always be generated over all activated speaker circuits.

Programming Messages to FACP Zones

To Program one of five messages to a speaker zone, press the *ENTER* key at the FACP. The following screen will be displayed:

```

1=READ STATUS MODE
2=PROGRAMMING MODE
3=FUTURE USE
4=REMOTE DOWNLOAD

```

Access Programming Mode by pressing the 2 key. The following screen will be displayed:



Entering the *Master* level password (default 00000) will cause the following screen to appear:



Select the *Input Zone* option by pressing 1. The following screens will be displayed.

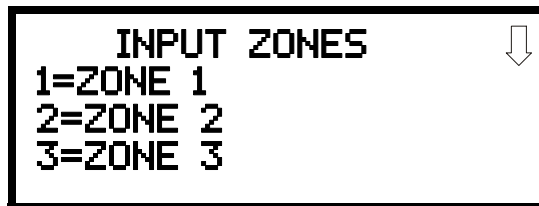

Input Zone Screen #1

Pressing the down arrow key will display additional Zones.

Pressing the number corresponding to the desired Zone while viewing an Input Zone screen will cause a screen similar to the following to be displayed:



Press the down arrow key 3 times until the following screen is displayed.

```

INPUT ZONE 1
1=FREEZE SUPV. NO
2=ACC MSG#
  
```

Press the 2 key to display the following screen:

```

ZONE MESSAGE
1=NO MESSAGE
2=MESSAGE 1
3=MESSAGE 2
  
```

```

ZONE MESSAGE
1=MESSAGE 3
2=MESSAGE 4
3=MESSAGE 5
  
```

Using these screens, the programmer can assign an audio message to each input zone. The selected message will play when the FACP is connected to an ACC-25/50ZS/T audio panel via the ANN-BUS and the corresponding FACP input goes into alarm. The factory default setting is Message 2.

Repeat the procedure outlined above for each speaker zone and then exit Programming by pressing the Escape (*ESC*) key to save the programming changes. Test the system to ensure proper operation.

Programming an FACP Zone as an ALL-CALL Zone

To Program a an FACP Zone as an ALL-CALL Zone, press 2 while viewing the following screen:

```

1=READ STATUS MODE
2=PROGRAMMING MODE
3=FUTURE USE
4=REMOTE DOWNLOAD
  
```

The following screen will be displayed:



Entering the *Master* level password (default 00000) will cause the following screens to appear:



Programming Screen #1

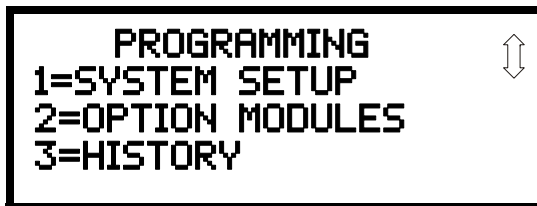

Programming Screen #2



Programming Screen #3

Access Option Modules by pressing the 2 key while viewing Programming Screen #2. The following screen will be displayed:

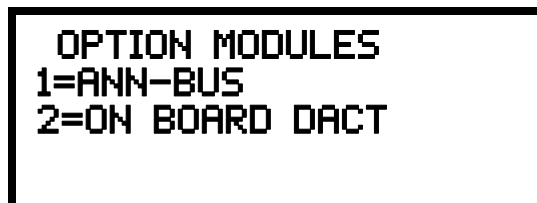

Press the *1* key to access the first ANN-BUS programming screen as shown below

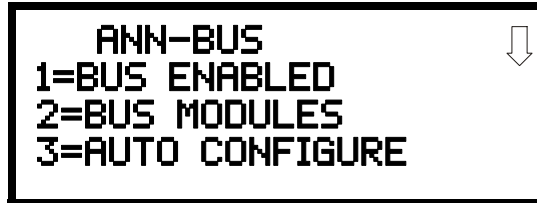

Press the down arrow key twice to view the following screen:

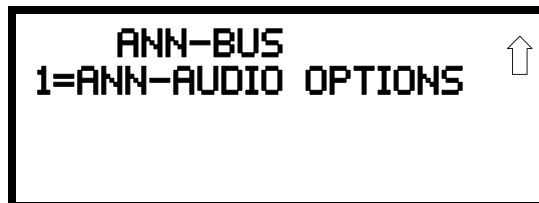

Pressing *1* for *ANN-AUDIO Options* while viewing ANN-BUS Screen #3 will cause the following screen to be displayed:

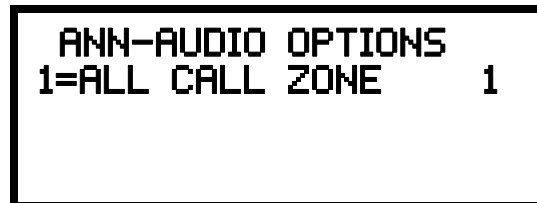

ANN-AUDIO Options Screen

This screen shows the Input Zone that has been assigned to be the All-Call Zone. In this example, Zone 1 is the All-Call Zone. The All-Call Zone can be changed by pressing the 1 key while viewing the ANN-AUDIO Options Screen. The following screens will be displayed.

```
ANN-AUDIO ALL CALL ↓
1=NO ALL CALL ZONE
2=INPUT ZONE 1
3=INPUT ZONE 2
```

Printer Options Screen #1

```
ANN-AUDIO ALL CALL ⇅
1=INPUT ZONE 3
2=INPUT ZONE 4
3=INPUT ZONE 5
```

Printer Options Screen #2

```
ANN-AUDIO ALL CALL ⇅
1=INPUT ZONE 6
2=INPUT ZONE 7
3=INPUT ZONE 8
```

Printer Options Screen #2

```
ANN-AUDIO ALL CALL ↑
1=INPUT ZONE 9
2=INPUT ZONE 10
```

Printer Options Screen #3

These screens allow the programmer to select which Input Zone will be assigned as the All-Call Zone.

Notes

Index

A

- AC branch circuit
 - calculation **98**
- AC Loss Relay **15, 16, 19, 27, 51**
 - Contact Rating **27, 51**
- AC Loss Response **76**
- AC On LED **25**
- AC Power **19**
 - see also Power On **69**
 - see also Primary Power **46**
 - wiring **46**
- ACC Communication **68**
- ACC-25/50 **26**
 - see also Audio•Command•Center•25/50 **13**
 - see also voice evacuation panel **13**
- ACC-25/50ZS **18**
 - programming **33**
- ACC-25/50ZS Modules **18**
- ACC-AAM25 **20, 28, 29**
 - Installation **57**
 - see also Audio Amplifier **13**
- ACC-EPM **30**
 - function **27**
 - installation **60**
 - LED **25**
 - see also External Page Module **22**
- ACC-FFT **22, 25**
 - LEDs **69**
 - Remote Phone **21**
- ACC-ZPMK **27**
 - DIP switch settings **35**
 - installation **52**
 - LEDs **24, 68, 77**
 - programming **39**
 - see also Zone Page Module **13, 21**
 - specifications **21**
 - switch functions **24, 66**
- ACC-ZSM
 - installation **54**
 - see also Zone Splitter Module **13, 21**
 - specification **21**
 - switch settings **41**
 - wiring **54**
- ACS
 - addressing **41**
- ACS Annunciator **109**
- Addressable Module Connections **103**
 - addressing **41**
- All-Call **23, 63**
 - ACC-25/50 **71**
 - ACC-25/50ZS **72**
 - Operation **71**
- Amplifier Fault **77**
- Amplifier Supervision **26, 28**
 - LED **70**
- ANN-BUS Annunciator **130**
- Answer Call **25**
- Answer Call LED **69**
- Application **14, 80**
 - One Speaker Circuit **80**
 - One Speaker Circuit with Backup **81**
 - Two Speaker Circuits with Dual Input **83**
 - Two Speaker Circuits with Five Messages **85**
- Audio Amplifier Module **20, 28, 29**
 - Installation **57**
 - Jumper **57, 58**
 - see also ACC-AAM25 **13**
 - Switch S1 **57**
- Audio Conversion Module **29**
 - Installation **58**
 - see also audio transformer module **14**
 - see also FC-XRM70 **28**
- Audio Input **14, 22, 26**
 - Input Current **22**
 - Input Impedance **22**
 - Input Voltage **22**
- Audio Input Jack **26**
- Audio On/Off **71**
- Audio Power **14**
 - 25 watts **14, 20**
 - 50 watts **14**
- audio transformer module **13**
- AUDIO•COMMAND•CENTER•25/50
 - see also ACC-25/50 **13**
 - see also Voice Evacuation Control Panel **13**
- Auxiliary Power **15**
 - Connection **48**
 - see also Specific Application Power **22, 26, 48**

B

- Backbox **44**
- Backbox Installation **42**
- Background Music **14, 26, 32, 37, 64, 77**
- Backup
 - Audio Amplifier **20, 29, 57, 81**
 - Audio Amplifier Switch S1 **20**
 - message generator **13**
 - tone generator **13**
- Battery **20, 28**
 - Calculations **98**
 - Charger **26, 28**

- Charger Capacity **20**
- Charging Circuit **20**
- Precaution **47**
- see also Secondary Power **47**
- Battery Box **44**
- battery charger
 - enable/disable **39**
- battery requirements
 - NFPA **100**
- battery selection **100**
- battery size
 - calculation **100**
- Battery Trouble LED **25, 69**
- Battery Trouble Response **76**
- board layout **16**
- Bypass Switch
 - see also Record Bypass Switch **38**

C

- Cabinet **28**
 - Dimensions **43**
- calculating
 - AC branch circuit **98**
 - battery size **100**
 - system current draw **98**
- Charger Trouble LED **25, 69**
- Charger Trouble Response **76**
- Chime Tone **14, 36**
- Circuit **26**
 - Nonpower-limited **56**
 - power-limited **56**
- Circuit Trouble LED **25, 70**
- Class A **28**
- Class B **28**
- CMD **48**
 - Priority **38**
 - Programming **37**
 - see also Command Input Circuit **14**
- CMD Activation
 - Contact Closure **49**
 - NAC Polarity Reversal **48**
- CMD1 **26, 48, 76**
 - see also Command Input Circuit **20**
- CMD2 **26, 48, 76**
 - see also Command Input Circuit **20**
- CMD3 **26, 49, 76**
 - see also Command Input Circuit **20**
- CMD4 **26, 49, 76**
 - see also Command Input Circuit **20**
- CMD5 **26, 49, 76**
 - see also Command Input Circuit **20**
- Command Input Circuit **14, 20, 48**
 - Contact Closure Current **20**
 - End-of-Line Resistor 4.7K **20**
 - Operating Voltage **20**
 - Reverse Polarity Current **20**

- see also CMD **13, 26**
- Command Input Circuit 1
 - Programming **37**
- Command Input Circuit 2
 - Programming **37**
- components, standard **13**
- Contact Rating
 - AC Loss Relay **19**
 - System Trouble Relay **22**
- Contact-closure **20**
- Control
 - see also Push-button **23, 63**
- Custom Message **14**
 - 12 second (five) **14**
 - 15 second (four) **14**
 - 20 second (three) **14**
 - 30 second (two) **14**
 - 60 second (one) **14**

D

- DIP switch settings
 - ACC-ZPM **35**
- DIP Switches
 - S1 **32, 36**
 - S3 **32, 37**
 - S5 **32, 37**
- Disable **65**
- Dress Panel **15, 29**
- Dual Zone operation **35, 38**

E

- Earth Ground Connection **46**
- EIA-485
 - addressing **41**
- End-of-Line Resistor **49**
 - Audio Amplifier 4.75K **20**
 - Command Input Circuit 4.7K **20**
- External Audio
 - Recording **37**
- External Page Module **30**
 - function **27**
 - installation **60**
 - LED **25**
 - specification **22**

F

- FACP Communication **68**
- FACP selection **35**
- FC-LPS **24**
 - Installation **59**
 - see also Local Playback Speaker **27, 29, 59**
- FC-MIM **29**
 - see also Microphone Interface Module **15, 22, 27**
- FC-RM **21, 29**

see also Remote Microphone **15, 22, 27**
 FC-XRM70 **28, 29**
 Installation **57, 58**
 see also Audio Conversion Module **28**
 see also Transformer Module **58**
 Fire Alarm Control Panel
 see also FACP **13**
 Fire Alarm Operation **70**
 Fire Alarm Restoral **70**
 Fire Fighter Telephone Module **21, 25**
 Form-C **16**
 see also Relay **51**
 see Relay **22, 26**
 FPJ-F phone jack **55, 75, 116**

G

Ground Fault LED **25, 70**
 Ground Fault Response **76**

H

Hi-Lo Tone **14, 36**

I

Indicator
 see also LED **23, 63**
 Input Circuit **26, 48**
 Installation
 Transformer **45**

J

Jumper
 Audio Amplifier **20**

K

Keypad
 labels **66**
 Keypad Labels **66**
 Keys
 see also Push-buttons **66**
 Keyswitch
 Remote Phone Jack **21**
 Knockout Locations
 Cabinet **43**

L

Labels
 replacing **66**
 LED **24, 28, 57, 67**
 AC On **25**
 AC Power **69**
 Amplifier Supervision **26, 70**
 Battery Trouble **25, 69**
 Charger Trouble **25, 69**

Circuit Trouble **25, 70**
 Ground Fault **25, 70**
 Message **24**
 Message 1 **68**
 Message 2 **68**
 Message 3 **68**
 Message 4 **68**
 Message 5 **68**
 Message Generator Trouble **24, 67**
 Microphone Trouble **24, 67**
 Power On **24, 67**
 Record/Playback **24, 67**
 Remote Microphone Trouble **70**
 System Trouble **24, 67**
 Tone Generator Trouble **24, 67**
 Zone 1 **24, 67**
 Zone 2 **24, 67**
 Local Handset Trouble **25**
 Local Handset Trouble LED **69**
 Local Playback Speaker **15, 16, 27, 29, 65**
 Installation **59**
 see also FC-LPS **59**

M

Main Circuit Board **27**
 Manual Evacuate **70**
 Manual Evacuate Restoral **71**
 Master CMD Out **21**
 current **21**
 Operating Voltage **21**
 Short Circuit Current **21**
 Master Command Bus Output **26, 76**
 current **26**
 End-of-Line Resistor **49**
 see also Master CMD **49**
 voltage **26**
 Message **23, 63**
 Message 1 LED **24, 68**
 Message 2 LED **24, 68**
 Message 3 LED **24, 68**
 Message 4 LED **24, 68**
 Message 5 LED **24, 68**
 Message Assignment **110**
 Message Control Selections **37**
 message generator **13**
 Message Generator Trouble LED **24, 67**
 Message Generator Trouble Response **76**
 message recording **13**
 Message Repeat **36**
 message review **65**
 Messages
 Sample **102**
 Microphone **13, 14, 64**
 integral **22**
 time-out feature **14**
 Microphone Interface Module **22, 29**

see also FC-MIM 15, 27
 Microphone Recording 37
 Microphone Trouble LED 24, 67
 Microphone Trouble Response 76
 Modules
 Optional 57
 Mounting
 surface 42
 Mounting Cabinet
 Surface Mount 42
 Mounting Panel 42
 MR-101C 21, 50
 MR-201C 21, 50
 MS-10UD 127
 MS-5UD 127
 MS-9200UD 106
 MS-9600 106

N

NAC 13, 48, 51, 78
 Operation 77
 see also Notification Appliance Circuit 13, 26
 Style Y 14, 26
 Style Z 14, 26
 Nonpower-limited Circuit 56
 Notification Appliance Circuit 13, 14, 26, 48, 51
 see also NAC 26

O

Operation 70
 Option Modules 29, 57
 Output Circuit 26, 49

P

Paging
 ACC-25/50 Dual Zone 74
 ACC-25/50 Single Zone 73
 ACC-25/50ZS 74
 Operation 73
 Password
 Master Level 1 113, 117, 132, 134
 PC Jack 26
 Piezo 14
 Playback 24, 64
 Enable 37, 65
 Power 14, 15, 22, 46, 77, 79
 ACC-FFT LED 69
 see also AC power 19
 see also Specific Application Power 26
 Power On LED 24, 67
 Power Supply 28
 calculations 98
 Power-limited Circuit 20, 21, 28, 56
 Primary Power

see also AC power 46
 Product Description 13
 Product Features 14
 Programmed Activation by FACP 105
 Programming 20, 26, 32, 48
 AC Loss Reporting Delay 38
 ACC-ZPMK 33
 CMD 37
 Command Input Circuit #1 37
 Command Input Circuit #2 37
 DIP Switches 32
 Message Control Selections 37
 S1 DIP Switch 33
 S3 DIP Switch 34
 S5 DIP Switch 34, 35
 programming
 MS-9200UD 109, 125, 130
 MS-9600 125, 130
 Push-button
 Audio On/Off 23, 63
 Message 23, 63
 Record/Playback 24
 see also Control 23, 63
 Trouble Silence 24, 64

R

RCA Jack 22
 see also Audio Input 22
 Record 65
 Bypass Switch 38
 Enable 37
 From Microphone 37
 from PC Jack 37
 From RCA Jack 37
 How to 64
 Procedure 64
 Push-button 64
 Record Bypass 64
 Record Enabling 65
 Record LED 24, 67
 Record/Playback 24, 64
 Relay 15, 21, 26
 AC Loss 19
 AC Power Loss 51
 AC power loss 15
 system trouble 15
 Trouble 22, 51
 Remote Fire Fighter Telephone Status LED 69
 Remote Handset Page 25
 Remote Handset Page LED 69
 Remote Handset Trouble 25
 Remote Handset Trouble LED 69
 Remote Key Trouble 25
 Remote Key Trouble LED 69
 Remote Microphone 29
 ACC-FFT 21

- Operation **77**
 - see also FC-RM **15, 22, 27**
- Remote Microphone Installed Switch
 - see also SW1 **39**
- Remote Microphone Module **21**
- Remote Microphone Page **25**
- Remote Microphone Page LED **69**
- Remote Microphone Trouble **25**
- Remote Microphone Trouble LED **69, 70**
- Remote Phone Jack
 - Keyswitch **21**
- replacing **66**
- RPJ-F phone jack **55, 75, 116**

S

- S1
 - DIP Switch Settings **36**
- Secondary Power
 - see also Battery **47**
- Selecting **100**
- Settings **35**
- Single Zone operation **23, 35, 38, 63**
- Slow-Whoop Tone **14, 36**
- Sounder **14**
 - see also Piezo **14**
- Speaker Circuit **14, 20, 51**
 - End-of-Line Resistor 4.75K **20**
 - Operating Voltage **20**
 - see also NAC **14**
 - Style Y **20**
 - Style Z **20**
- Speaker Module
 - see also Local Playback Speaker **60**
- Specific Application Power **22, 48**
 - see also Auxiliary Power **26, 48**
- Specifications **19**
- split amplifier **41**
- Steady Tone **14, 36**
- Style Y **28**
- Style Z **28**
- Supervision **13, 21, 28**
- Surface Mount **42**
- SW1
 - see also Remote Microphone Switch **39**
- Switch
 - Functions **63**
 - S1 Audio Amplifier **20**
- system current draw
 - calculation **98, 99**
- system status **70**
- System Trouble LED **24, 67**

T

- Temporal Pattern Programming **36**
- time-out feature
 - microphone **14**

- Tone **14**
 - After Message **36**
 - Before Message **36**
 - Generator **13, 14**
 - Programming **36**
- Tone Generator Fault Response **76**
- Tone Generator Trouble LED **24, 67**
- Transformer **16**
- Transformer Conversion Module
 - Installation **57**
- Transformer Installation **45**
- Transformer Module
 - 70.7 volt Conversion **58**
 - see also FC-XRM70 **58**
- Trouble Relay **15, 16, 22, 26, 51**
 - Contact Rating **22, 26, 51**
- Trouble Response **76**
- Trouble Restoral **78**
- Trouble Silence **24, 64**

U

- UL Power-limited Wiring **56**

V

- voice evacuation panel
 - see also ACC-25/50 **13**

W

- wiring from ACC-25/50ZS to
 - MS-5UD and MS-10UD **129**
 - MS-9200UD **107**
 - MS-9600 **107**
- Wiring Requirements **104**

Z

- Zone 1 LED **24, 67**
- Zone 2 LED **24, 67**
- Zone Assignment **109, 125, 130**
- Zone Page Module **21, 27**
 - installation **52**
 - LEDs **25**
 - programming **39**
 - see also ACC-ZPMK **13**
 - switch functions **24**
- Zone Splitter Module **21**
 - see also ACC-ZSM **13**
 - switch settings **41**
 - wiring **54**
- Zone/Circuit Active **68**
- Zone/Circuit Trouble **69**

Manufacturer Warranties and Limitation of Liability

Manufacturer Warranties. Subject to the limitations set forth herein, Manufacturer warrants that the Products manufactured by it in its Northford, Connecticut facility and sold by it to its authorized Distributors shall be free, under normal use and service, from defects in material and workmanship for a period of thirty six months (36) months from the date of manufacture (effective Jan. 1, 2009). The Products manufactured and sold by Manufacturer are date stamped at the time of production. Manufacturer does not warrant Products that are not manufactured by it in its Northford, Connecticut facility but assigns to its Distributor, to the extent possible, any warranty offered by the manufacturer of such product. This warranty shall be void if a Product is altered, serviced or repaired by anyone other than Manufacturer or its authorized Distributors. This warranty shall also be void if there is a failure to maintain the Products and the systems in which they operate in proper working conditions.

MANUFACTURER MAKES NO FURTHER WARRANTIES, AND DISCLAIMS ANY AND ALL OTHER WARRANTIES, EITHER EXPRESSED OR IMPLIED, WITH RESPECT TO THE PRODUCTS, TRADEMARKS, PROGRAMS AND SERVICES RENDERED BY MANUFACTURER INCLUDING WITHOUT LIMITATION, INFRINGEMENT, TITLE, MERCHANTABILITY, OR FITNESS FOR ANY PARTICULAR PURPOSE. MANUFACTURER SHALL NOT BE LIABLE FOR ANY PERSONAL INJURY OR DEATH WHICH MAY ARISE IN THE COURSE OF, OR AS A RESULT OF, PERSONAL, COMMERCIAL OR INDUSTRIAL USES OF ITS PRODUCTS.

This document constitutes the only warranty made by Manufacturer with respect to its products and replaces all previous warranties and is the only warranty made by Manufacturer. No increase or alteration, written or verbal, of the obligation of this warranty is authorized. Manufacturer does not represent that its products will prevent any loss by fire or otherwise.

Warranty Claims. Manufacturer shall replace or repair, at Manufacturer's discretion, each part returned by its authorized Distributor and acknowledged by Manufacturer to be defective, provided that such part shall have been returned to Manufacturer with all charges prepaid and the authorized Distributor has completed Manufacturer's Return Material Authorization form. The replacement part shall come from Manufacturer's stock and may be new or refurbished. THE FOREGOING IS DISTRIBUTOR'S SOLE AND EXCLUSIVE REMEDY IN THE EVENT OF A WARRANTY CLAIM.

Warn-HL-08-2009.fm



World Headquarters
1 Firelite Place
Northford, CT 06472-1653 USA
203-484-7161
fax 203-484-7118

www.firelite.com



Free Manuals Download Website

<http://myh66.com>

<http://usermanuals.us>

<http://www.somanuals.com>

<http://www.4manuals.cc>

<http://www.manual-lib.com>

<http://www.404manual.com>

<http://www.luxmanual.com>

<http://aubethermostatmanual.com>

Golf course search by state

<http://golfingnear.com>

Email search by domain

<http://emailbydomain.com>

Auto manuals search

<http://auto.somanuals.com>

TV manuals search

<http://tv.somanuals.com>