



# Honeywell

## Owner's Guide

### **TrueIQ<sup>®</sup>**

Digital IAQ Control

---



69-2072-05

## Table of contents

### User Information

About TrueIAQ® .....	1
Operation .....	2
Display screen reference .....	3

### Adjusting IAQ settings

Changing humidifier settings.....	4
Changing dehumidifier settings...	6
Changing ventilation settings .....	6
Changing time of day.....	7
Service timers.....	7

### Installer Information

Installation .....	8
Wiring .....	10
Mounting the outdoor sensor.....	16
Advanced programming .....	17

### Appendices

Standards .....	21
Warranty information.....	22

## Need Help?

For assistance with this product please visit <http://yourhome.honeywell.com>  
or call Honeywell Customer Care toll-free at **1-800-468-1502**

## Read and save these instructions.

© U.S. Registered Trademark. Patents pending. Part number DG115EZIAQ.  
Copyright © 2008 Honeywell International Inc. All rights reserved.

## About TrueIAQ®

The TrueIAQ® monitors and automatically adjusts operation of your whole-house humidifier, dehumidifier, ventilator, or bath fan.

Maintaining proper indoor humidity minimizes the potential for unhealthy airborne pollutants to grow. Having too little humidity can leave you vulnerable to infections and uncomfortable dry skin. Too much humidity creates ideal breeding grounds for mold, mildew and dust mites. Humidified air also feels warmer in the winter, and dry air feels cooler in the summer.

TrueIAQ can adjust humidity with or without dependency on HVAC equipment operation. If you have both a humidifier and dehumidifier installed, the TrueIAQ can automatically change over to the appropriate equipment based on your comfort settings and the changing outdoor conditions.

TrueIAQ can also deliver fresh air with or without dependency on HVAC equipment operation. Today's building codes require homes to be built more tightly for energy efficiency, but that tightness can also trap indoor air pollutants, such as cooking odors, cleaning agents, radon, and carbon dioxide/monoxide. TrueIAQ provides cost-effective ventilation in accordance to industry standards. In addition, the TrueIAQ can be programmed to deliver ventilation during set times of the day or night.

## Operation

TrueIAQ<sup>®</sup> can be used to control the humidity levels in your home, and control fresh air intake in accordance to industry recommendations (ASHRAE 62.2).

**Comfort Settings:** Feedback on your indoor IAQ conditions.

**Outdoor Conditions<sup>1</sup>:** Actual outdoor temperature and humidity.

**Equipment Operation:** Displays what equipment is operating at a given time.

**More:** Advances between installed IAQ equipment control options.

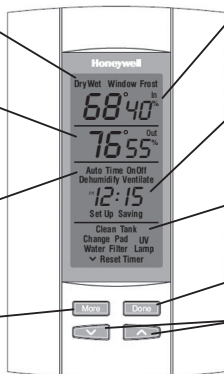

**Indoor Conditions:** Actual indoor temperature and humidity.

**Programmable Clock:** Displays time and allows IAQ equipment programming based on time.

**Maintenance Reminders:** Notifies you when your equipment needs service.

**Done:** Saves changes.

**Toggle Arrows:** Changes the comfort levels of your IAQ equipment operation.

<sup>1</sup> Actual outdoor temperature and humidity will only be displayed if the outdoor sensor is installed.

## Display screen reference

**Dry:** Indoor humidity levels are below 20% relative humidity (RH.)

**Wet:** Indoor humidity levels are above 60% RH.

**Window Frost:** The control is protecting your home against too much humidity based on outdoor conditions. Humidity levels in your home may not reach your desired RH% setting as a result.

**De Humidify:** If "Humidify" is displayed, the control is calling for more humidity. If "DeHumidify" is displayed, the control is calling for humidity removal.



**Indoor temperature and humidity.**

**Outdoor temperature and humidity.**

**Ventilate:** Fresh air ventilation is on.

**Service Reminders:** All are timer-based and will be displayed to indicate what service is needed.

## Changing humidifier settings

**Note:** These items will appear only if a humidifier is installed on your system.

1. Set humidifier by pressing UP/DOWN arrows.

Tables below are recommended initial humidity settings based on outdoor temperature. If window frost setting (see next page) is not being used, the humidity setting should be adjusted manually when outdoor conditions change.

Outdoor Temp.	Setting
-20°F (-29°C)	15%
0°F (-18°C)	25%
20°F (-7°C)	35%

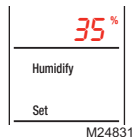

Red font is blinking on screen.

If both humidifier (hum) and dehumidifier (dehum) are installed:

Dehum setpoint can only be equal to or higher than Hum setpoint. If equal, equipment changeover will be at least 5% higher (dehum) or lower (hum).

If not equal, changeover occurs at setpoint plus 2% RH (control's deadband).

## Changing humidifier settings

2. Press “More” to enter Window Frost Protection. Use the UP/DOWN arrows to set frost protection level.

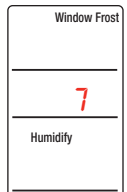
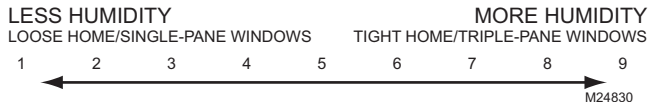

On the first cold day after TrueIQ® is installed, look for condensation on windows. If present, lower Frost Protection by one. Once set for your home, Frost Protection does not need to be changed again.

3. Press “More” again to enter operation style. Press the UP/DOWN arrows to set.

- “Auto” runs humidifier automatically according to settings.
- “Off” turns the humidifier off.

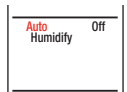

4. Press “Done” to save settings, or “More” to enter dehumidifier settings.

## Changing dehumidifier and ventilation settings

**Note:** These items will appear only if a dehumidifier is installed. If both a humidifier and dehumidifier are installed, these settings will appear after pushing “More” from the humidifier operation style screen.

1. Set dehumidifier by pressing the UP/DOWN arrows. RH% will change in increments of five.
2. Press “More” to enter operation style. Press the UP/DOWN arrows to set.
  - “Auto” runs dehumidifier automatically according to your RH% settings.
  - “Off” turns the dehumidifier off.
3. Press “Done” to save settings, or “More” to enter ventilation settings.

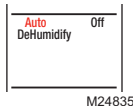
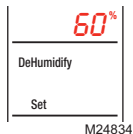

**Note:** These items will appear only if a ventilator is installed.

1. Use the UP/DOWN arrows to run ventilation temporarily. Range is from 20 to 480 minutes, in 20-minute increments.
2. Press “More” again to enter operation style.
  - “Auto” runs ventilation according to installer settings.
  - “ON” runs ventilation continuously.
  - “OFF” turns ventilation off. In this mode, ventilation will only run if turned on by a remote switch.
3. Press “Done” to save settings, or “More” to enter time settings.

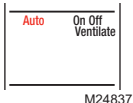



## Changing time of day and service timers

1. Press “More.” Adjust hour using the the UP/DOWN arrows.
2. Press “More.” Adjust minutes using the UP/DOWN arrows.
3. Press “Done” to save settings.

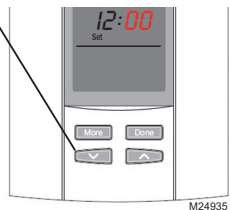
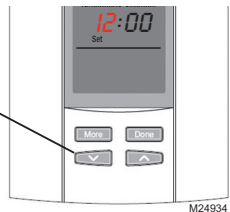

### Service Timers

Service timers appear when the humidifier, dehumidifier, ventilator, air filter, and/or UV bulbs need service. Your HVAC technician will set these timers during installation.

### Resetting Service Timers

Press and hold the DOWN arrow for 5 seconds to reset your service timers.

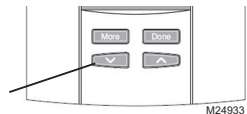

## Installation



**CAUTION: ELECTRICAL HAZARD.** Can cause electrical shock or equipment damage. Disconnect power before beginning installation.

1. Turn system power off.
2. Choose a location. TruelAQ® can be mounted to a wall or directly to the return duct.

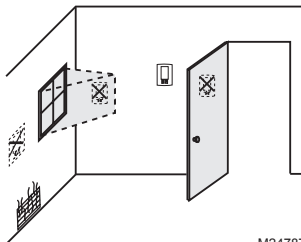
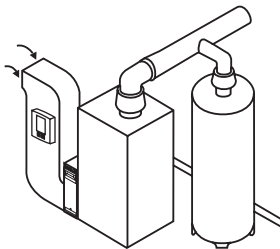

## Installation

- Loosen the cover screw.
- Separate the front housing from the base.



- For wall mounting, run wires through the back hole to the terminals. Wire size for all connectors: 2 x 18 AWG to 1 X 22 AWG. Install the mounting plate using two screws.

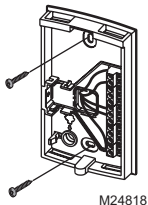

- For duct mounting, (A) snap out side wall clip and attach as shown. Run wires through the side wall hole, under the clip, to the terminals. (B) Snap in sensor cap.
- Reinstall the front housing on the power base, and secure with screw.

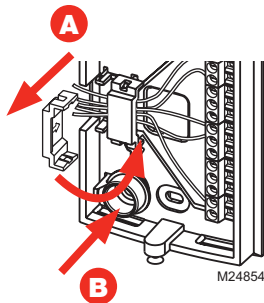

- Note:** If duct mounted, ensure sensor cap tip aligns with air flow in duct.
- Apply power to the system.

## Wiring

	Pin	Pin description	Pin capacity
R	R	24V supply. Must be common to G output.	24Vac±20% 1.5 amp max
C	C	24V supply common.	24Vac±20%
Sensor	Sensor	Communication and supply bus to remote sensors (sensor pins not polarized).	24Vdc 64mA max out
Sensor	Switch	Override switch input. Active when R is applied	24Vac±20%, 10mA max in
Switch	W	W input to sense when the thermostat is calling for heat. Active when R is applied.	24Vac±20%, 10mA max in
W	G	G input to sense fan calls. Active when R is applied. Fan output to activate system fan. R8222 Isolation Relay may be required if G is not isolated through the thermostat.	24Vac±20%, 10mA max in 24Vac from R, 1Amp max out
G	Vent 1	Dry contact output. Opens the vent damper of an HRV or the bathroom fan and Damper.	24Vac from R, 1Amp max out
Vent	Vent 2		
Vent	Dehum 1	Dry contact output. Starts the Dehumidifier or an alternate fan speed.	24Vac from R, 1Amp max out
Dehum	Dehum 2	Dry contact output. Starts the Humidifier.	24Vac from R, 1Amp max out
Dehum	Hum 1		
Hum	Hum 2		

M24819

## Wiring

Wiring TruelAQ® with a non-powered humidifier.

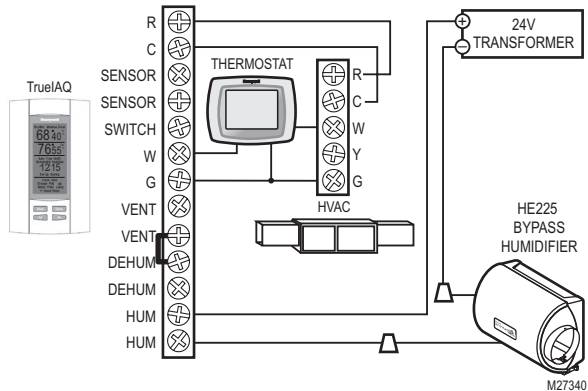

## Wiring

Wiring TruelAQ® with a powered humidifier.

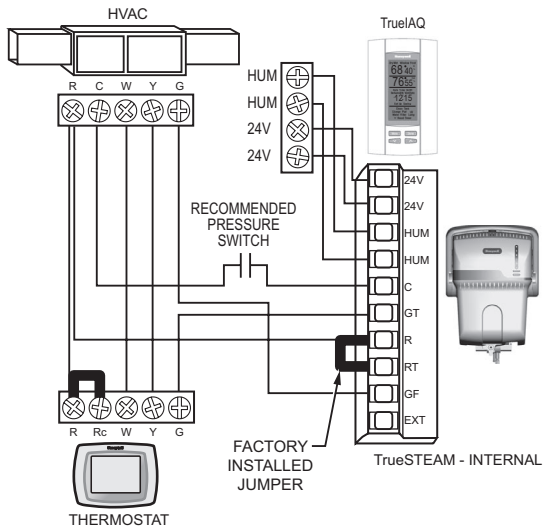

NOTE: IF PRESSURE SWITCH IS USED, ENSURE DIP 5 IS IN POSITION. M27341

## Wiring

Wiring TruelAQ® with a dehumidifier and ventilation damper.

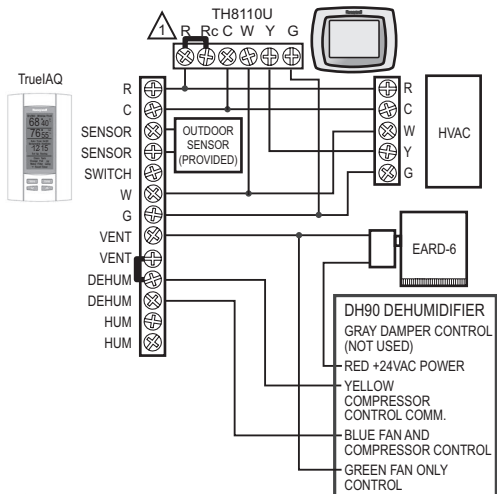

⚠️ IF A THERMOSTAT OTHER THAN A TH5110, TH5220, TH5320, TH6110, TH6220, TH6320, TH8110, TH8320 OR TH8321 IS USED, A RELAY MAY BE REQUIRED TO ISOLATE THE G WIRE.

M27390

## Wiring

Wiring TruelAQ® with a humidifier and HRV/ERV ventilator.

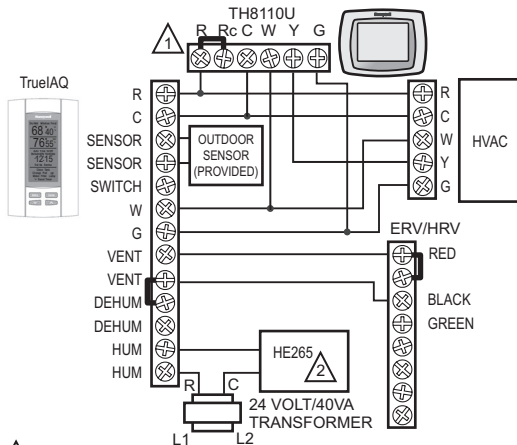

**1** IF A THERMOSTAT OTHER THAN A TH5110, TH5220, TH5320, TH6110, TH6220, TH6320, TH8110, TH8320 OR TH8321 IS USED, A RELAY MAY BE REQUIRED TO ISOLATE THE G WIRE.

**2** FOR WIRING OF HUMIDIFIER OTHER THAN THE HE265 READ THE INSTALLATION INSTRUCTIONS.

M27391



## Wiring

Wiring TruelAQ® with a non-powered humidifier, ventilation damper, and an auxiliary exhaust fan.

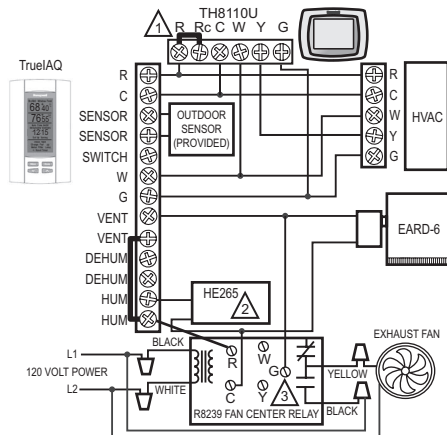

- 1 IF A THERMOSTAT OTHER THAN A TH5110, TH5220, TH5320, TH6110, TH6220, TH6320, TH8110, TH8320 OR TH8321 IS USED, A RELAY MAY BE REQUIRED TO ISOLATE THE G WIRE.
- 2 FOR WIRING OF HUMIDIFIER OTHER THAN THE HE265 READ THE INSTALLATION INSTRUCTIONS.
- 3 IF A RELAY OTHER THAN THE R8239 IS USED, A DEDICATED TRANSFORMER WITH AT LEAST 40 VA IS REQUIRED TO POWER THE HE265 AND EARD. IF AN R8239 IS USED (AS SHOWN IN THIS DIAGRAM) NO ADDITIONAL TRANSFORMER IS REQUIRED.

M27392

## Mounting the outdoor sensor

1. Do not mount on the south side of the house or in direct exposure to sunlight.
2. Keep at least 4 feet away from exhaust vents.
3. If in an air intake, place 1 foot closer to outside wall.
4. Place at least 6 inches higher than possible snow buildup.
5. Do not route sensor wire near high voltage wires.

**Note:** The sensor can be extended using 18-gauge wire.

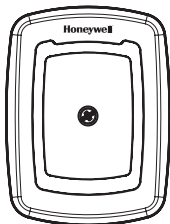

M24821



M24822

## Advanced HVAC installer setup instructions

1. Press and hold the UP/  
DOWN arrows for 3 seconds.

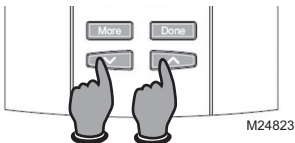

2. Press "More" to advance to the  
next setup option. See table on  
next page.

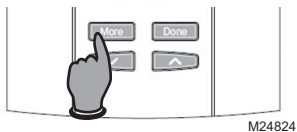

3. Use the UP/DOWN arrows to  
select options. See table on next  
page.

4. Press "Done" at any time to save and  
return to the home screen.

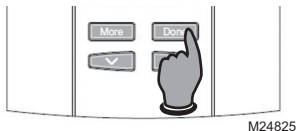

## Advanced programming

To be used by qualified HVAC technician.

Setup functions		Settings & Options (factory default in <b>bold</b> )	
10	Temperature Display	<b>1=Fahrenheit</b> ; 2=Celsius	
15	Frost Protection	0=Not installed <b>1=Frost Protection OFF</b> 2=Frost Protection ON	
20	Humidity High Limit	5%-80% in 5% increments; <b>40%</b>	
25	Humidifier Operation	0=Hum only while heat on <b>1=Hum only while fan on</b>	2=Hum forces fan on 3=Hum operates independent of fan
30	Programmed Humidity	<b>0=OFF</b> ; 1=ON	
35	Program Start Time (appears only if ISU30=1)	15 min increments <b>11:00 PM</b>	
40	Program End Time (appears only if ISU30=1)	15 min increments <b>7:00 AM</b>	
45	DEHUM Terminal Equipment Type	0=No Dehum (low speed vent) <b>1=Dehum only</b>	
50	High Dehum Limit	35%- <b>80%</b> , in 5% increments	
55	Low Dehum Limit	<b>35%</b> -80% in 5% increments	
60	Dehumidifier Operation	0=Dehum forces fan on <b>1=Dehum operates independent of fan</b>	
65	Humidity Display Offset	Set between -5% to 5% to recalibrate humidity sensing <b>0=OFF (no offset)</b>	
80	Hum Service Timer	<b>0,1,3,6,12</b> (months continuous)	

## Advanced programming

Setup functions		Settings & Options (factory default in <b>bold</b> )
85	Hum Service Timer	<b>0,1,3,6,12</b> (months intermittent)
90	Hum Water Filter Service	<b>0,1,3,6,12</b> (months intermittent)
95	Air Filter Service Timer	<b>0,1,3,6,12</b> (months continuous)
100	Vent Filter Service Timer	<b>0,1,3,6,12</b> (months continuous)
105	Vent Service Type	<b>0=Clean ventilation filter</b> 1=Change ventilation filter
110	UV Bulb Service Reminder	<b>0,6,12,24</b> (months continuous)
115	Vent Options	<b>0=No vent installed</b> 1=Ventilation using VENT contacts 2=Ventilation using VENT contacts for high speed and DEHUM contacts for low speed (only if dehum not installed) 3=Ventilation using VENT contacts and DEHUM contacts activated together (auxiliary ventilation device such as exhaust fan)
120	Vent Operation	0=Vent forces HVAC fan on <b>1=Vent operates independent of HVAC fan</b>
125	Programmed Vent	<b>0=OFF; 1=ON</b>
130	Program Start Time (appears only if ISU125=1)	15 min increments <b>5:00 PM</b>
135	Program End Time (appears only if ISU125=1)	15 min increments <b>9:00 AM</b>
140	ASHRAE: # of Bedrooms	1-6 bedrooms; <b>2</b>
145	ASHRAE: Home's Sq Ft	<b>10=1,000 Sq Ft;</b> up to 50=5,000 Sq Ft

## Advanced programming

Setup functions		Settings & Options (factory default in bold)
150	ASHRAE: CFM Setting	<b>3=30 CFM; 4=40 CFM, up to 20=200 CFM</b>
155	Maximum Vent	<b>00</b> ; 30%–95%. ( <b>00</b> setting runs to ASHRAE 100%)
160	Vent Shut-offs	<p><b>0=Auto vent regardless of outdoor conditions</b></p> <p>1=Off at 75°F dew point or 99°F air temp</p> <p>2=Low speed at 65°F dew point or 85°F air temp. Off at 75°F dew point or 99°F air temp</p> <p><b>Note:</b> If option 1 or 2 is selected, then ASHRAE 62.2 Standard will not be met.</p>
165	Dehumidification Via Fresh Air Ventilator	<p>0=Do not use ventilation for dehum</p> <p><b>1=Allow vent for dehum per outdoor conditions. With dehum installed, control to setpoint. Without dehum installed, control to the Hum setpoint +10% (max 60%).</b></p>

## Environmental standards/life expectancy

### TruelAQ® Control and Outdoor Sensor

- Operating/Storage temp: -40°F to 120°F (-40°C to 50°C)
- Condensation Protection: 0-100%
- Operating RH%: 0% to 99% non-condensing (TruelAQ). Outdoor sensor protected from condensation.
- Temp reading range: -40°C to 50°C (-40°F to 122°F)
- Temp accuracy within range: 0.4°C (0.72°F)
- Humidity reading range: 5% to 95%
- Humidity temp accurate reading range: -20°C to 50°C (-17°F to 122°F)
- Humidity accuracy over that range: ±4.5%
- Maximum real time clock drift over 1 year: 7 minutes
- Vertical mount to cover one gang box
- Flame Rating: UL94V-0
- RoHS compliant
- Relay life: 100,000 cycles at 1A 24Vac

### Power Supply

- 24Vac ± 20% 50, 60Hz (TruelAQ control)
- 24Vdc 2-wire over communication bus, not polarized (outdoor sensor)
- Protected against voltage spikes
- Not protected against over voltage connection (ex 120 or 240V)
- All setup parameters are stored indefinitely

### In the Event of Power Failure

- Real-time clock is maintained for 4 hours
- All outputs are deactivated
- All setup parameters are stored indefinitely

### Mechanical Design

Dimensions: 2-3/4" W x 4-3/4" H x 7/8" D (TruelAQ control); 2-3/4" W x 3-3/4" H x 7/8" D (Outdoor sensor)

Weight: .35 lbs (TruelAQ control); .15 lbs (Outdoor sensor)

Temperature Unit Display: °C/°F



## 5-year limited warranty

Honeywell warrants this product, excluding battery, to be free from defects in the workmanship or materials, under normal use and service, for a period of five (5) years from the date of purchase by the consumer. If at any time during the warranty period the product is determined to be defective or malfunctions, Honeywell shall repair or replace it (at Honeywell's option).

If the product is defective,

- (i) return it, with a bill of sale or other dated proof of purchase, to the place from which you purchased it; or
- (ii) call Honeywell Customer Care at 1-800-468-1502. Customer Care will make the determination whether the product should be returned to the following address: Honeywell Return Goods, Dock 4 MN10-3860, 1885 Douglas Dr. N., Golden Valley, MN 55422, or whether a replacement product can be sent to you.

This warranty does not cover removal or reinstallation costs. This warranty shall not apply if it is shown by Honeywell that the defect or malfunction was caused by damage which occurred while the product was in the possession of a consumer.

Honeywell's sole responsibility shall be to repair or replace the product within the terms stated above. HONEYWELL SHALL NOT BE LIABLE FOR ANY LOSS OR DAMAGE OF ANY KIND, INCLUDING ANY INCIDENTAL OR CONSEQUENTIAL DAMAGES RESULTING, DIRECTLY OR INDIRECTLY, FROM ANY BREACH OF ANY WARRANTY, EXPRESS OR IMPLIED, OR ANY OTHER FAILURE OF THIS PRODUCT. Some states do not allow the exclusion or limitation of incidental or consequential damages, so this limitation may not apply to you.

THIS WARRANTY IS THE ONLY EXPRESS WARRANTY HONEYWELL MAKES ON THIS PRODUCT. THE DURATION OF ANY IMPLIED WARRANTIES, INCLUDING THE WARRANTIES OF MERCHANTABILITY AND FITNESS FOR A PARTICULAR PURPOSE, IS HEREBY LIMITED TO THE FIVE-YEAR DURATION OF THIS WARRANTY. Some states do not allow limitations on how long an implied warranty lasts, so the above limitation may not apply to you.

This warranty gives you specific legal rights, and you may have other rights which vary from state to state.

If you have any questions concerning this warranty, please write Honeywell Customer Relations, 1985 Douglas Dr, Golden Valley, MN 55422 or call 1-800-468-1502. In Canada, write Retail Products ON15-02H, Honeywell Limited/Honeywell Limitée, 35 Dynamic Drive, Toronto, Ontario M1V4Z9.

## Automation and Control Solutions

Honeywell International Inc.  
1985 Douglas Drive North  
Golden Valley, MN 55422

Honeywell Limited-Honeywell Limitée  
35 Dynamic Drive  
Toronto, Ontario M1V 4Z9

<http://yourhome.honeywell.com>

® U.S. Registered Trademark.  
© 2008 Honeywell International Inc.  
Patents pending.  
69-2072—05 M.S. Rev. 07-08



Printed in U.S.A. on recycled paper containing at least 10% post-consumer paper fibers.

# Honeywell



## Free Manuals Download Website

<http://myh66.com>

<http://usermanuals.us>

<http://www.somanuals.com>

<http://www.4manuals.cc>

<http://www.manual-lib.com>

<http://www.404manual.com>

<http://www.luxmanual.com>

<http://aubethermostatmanual.com>

Golf course search by state

<http://golfingnear.com>

Email search by domain

<http://emailbydomain.com>

Auto manuals search

<http://auto.somanuals.com>

TV manuals search

<http://tv.somanuals.com>