

## PROGRAMMABLE THERMOSTAT BY HONEYWELL

Weekday/Weekend (5-day/2-day)  
Programmable Heat and/or Cool  
Low Voltage (20 to 30 Vat)  
Thermostat and Mounting Plate  
Model CT2400

# MagicStat®

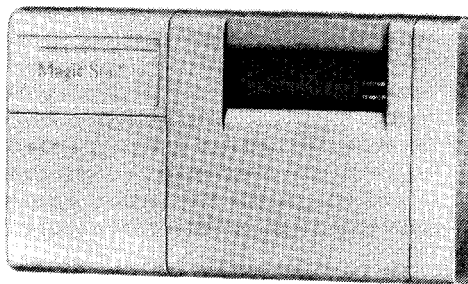

### PROGRAMMING AND INSTALLATION INSTRUCTIONS

## Limited One-Year Warranty

Honeywell warrants this product, excluding battery, to be free from defects in the workmanship or materials, under normal use and service, for a period of one (1) year from the date of purchase by the consumer. If, at any time during the warranty period, the product is defective or malfunctions, Honeywell shall repair or replace it (at Honeywell's option) within a reasonable period of time.

If the product is defective,

- (i) return it, with a bill of sale or other dated proof of purchase, to the retailer from which you purchased it, or
- (ii) package it carefully, along with Proof of purchase (including date of purchase) and a short description of the malfunction, and mail it, postage prepaid, to the following address:

**Honeywell Inc.** in Canada: **Honeywell Limited/Honeywell Limitée**  
Return Goods Department Product Services ON 15-FFE  
1050 Berkshire Lane 740 Ellesmere Road  
Plymouth, MN 55441-4437 Scarborough, Ontario M1P 2V9

This warranty does not cover removal or reinstallation costs. This warranty shall not apply if it is shown by Honeywell that the defect or malfunction was caused by damage which occurred while the product was in the possession of a consumer.

Honeywell's sole responsibility shall be to repair or replace the product within the terms stated above. HONEYWELL SHALL NOT BE LIABLE FOR ANY LOSS OR DAMAGE OF ANY KIND, INCLUDING ANY INCIDENTAL OR CONSEQUENTIAL DAMAGES RESULTING, DIRECTLY OR INDIRECTLY, FROM ANY BREACH OF ANY WARRANTY, EXPRESS OR IMPLIED, OR ANY OTHER FAILURE OF THIS PRODUCT. Some states do not allow the exclusion or limitation of incidental or consequential damages, so this limitation may not apply to you.

THIS WARRANTY IS THE ONLY EXPRESS WARRANTY HONEYWELL MAKES ON THIS PRODUCT. THE DURATION OF ANY IMPLIED WARRANTIES, INCLUDING THE WARRANTIES OF MERCHANTABILITY AND FITNESS FOR A PARTICULAR PURPOSE, IS HEREBY LIMITED TO THE ONE YEAR DURATION OF THIS WARRANTY. Some states do not allow limitations on how long an implied warranty lasts, so the above limitation may not apply to you.

This warranty gives you specific legal rights, and You may have other rights which vary from state to state.

If you have any questions concerning this warranty, please write our Customer Assistance Center, Honeywell Inc., P.O. Box 524, Minneapolis, MN 55440-0524 or call 1-800-468-1502, Monday-Friday, 7:00 a.m. to 5:30 p.m., Central time. In Canada, write Retail Products ON1 5-02H, Honeywell Limited/Honeywell Limitée, 740 Ellesmere Road, Scarborough, Ontario M1P 2V9.

35

### TYPICAL ENERGY SAVINGS FOR REPRESENTATIVE CITIES IN THE U.S. AND CANADA

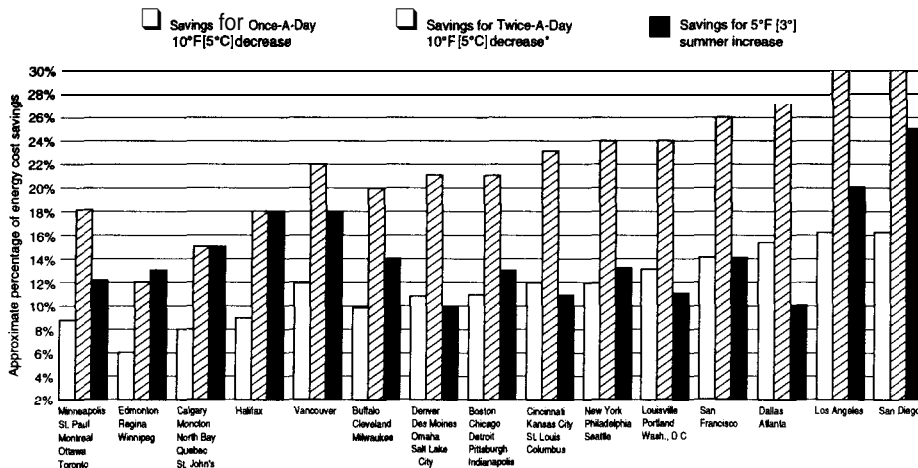

\*Based on 10°F [5°C] decrease-(5°F [3°C] decrease gives approximately 55 percent of these savings.) M2416A

Thermostat patents pending.

Printed in U.S.A. G.S. 7-93 ©Honeywell Inc. 1993

Form Number 69-0789 CT2400

Form Number 69-0789 CT2400

Welcome to the world of comfort and energy savings with your new Honeywell MagicStat® programmable thermostat.

Your new thermostat will automatically control the temperature in your home, keeping you comfortable while saving energy when programmed according to the instructions in this manual.

Direct any questions concerning the application of this thermostat to Honeywell Customer Assistance at 1-800-468-1502, Monday-Friday 7:00 a.m.-5:30 p.m., Central time.

## @ RECYCLING THERMOSTAT

If this thermostat is replacing a thermostat that contains mercury in a sealed tube (see illustration below), do *not* place your old thermostat in the trash. Contact your local waste management authority for instructions regarding the recycling and proper disposal of your old thermostat.

If you have questions, call Honeywell Inc. at 1-800-468-1502.

Typical location of a mercury switch in a thermostat.

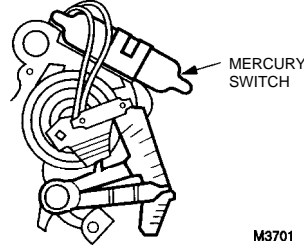

M3701

## Table Of Contents

STEP 1 Prepare For Installation .....	2
STEP 2 Remove Old Thermostat .....	4
STEP 3 Install The Batteries .....	6
STEP 4 Program The Thermostat .....	8
STEP 5 Adjust Fan Operation Switch, As Required .....	16
STEP 6 Adjust System On-Time, As Required .....	16
STEP 7 Mount Thermostat Mounting Plate .....	18
STEP 8 Wire Thermostat Terminals .....	20
STEP 9 Mount The Thermostat .....	24
STEP 10 Check Thermostat Operation After Programming And installing .....	25
STEP 11 Set The Fan And System Switches .....	27
Troubleshooting Guide .....	29
Limited One-Year Warranty .....	35

1

□ Acquire tools and items below as needed. Also purchase two AA alkaline batteries; we recommend Energizer batteries.

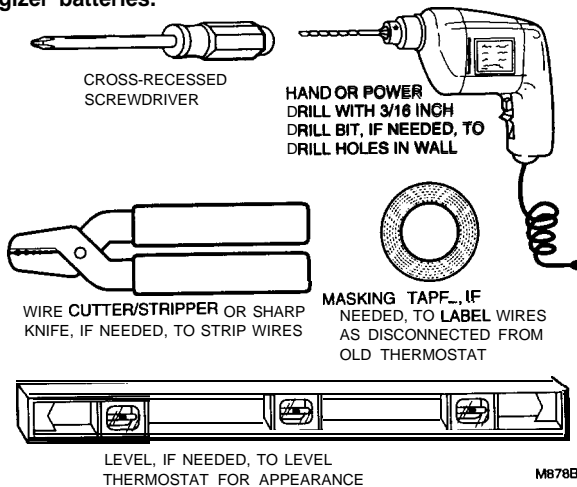

3

## STEP 1 Prepare For Installation

☐ Check Table 1 to make sure this thermostat is compatible with your system. If it is not, return to retailer. For more information, call Honeywell Customer Assistance, toll-free 1-800-468-1502.

TABLE 1 -COMPATIBILITY CHART.

System Type	Compatible With CT2400
Gas—Standing Pilot	Yes
Gas—Electronic Ignition	Yes
Gas-Fired Boilers	Yes <sup>1</sup> <sup>2</sup>
Gas—Millivolt	No
Oil-Fired Boilers	Yes <sup>1</sup> <sup>2</sup>
Oil-Fired Furnace	Yes
Electric Furnace	Yes
Electric Air Conditioning	Yes
Baseboard Electric (120/240 Line Volt)	No
Heat Pumps/Multistage Equipment	No

~~Not compatible with any 120/240 volt circuit.~~

- <sup>1</sup> Compatible with 2-wire Honeywell zone valves. Isolating relay required for 3-wire thermostats for zone valves. Not compatible with 2-wire White-Rodgers no. 1361 valves.
- <sup>2</sup> Compatible with hot water baseboard systems. Will not work efficiently on steam or gravity systems.

## STEP 2 Remove Old Thermostat

[1 Test to make certain that your heating and cooling systems are working properly. If either does not work, contact your local heating/air conditioning dealer. To avoid compressor damage, do not operate the cooling system when outdoor temperature is below 50° F/10° C].

- ☐ TURN OFF POWER to system at the furnace, or at the fuse/circuit breaker panel.
- ☐ Carefully unpack your new thermostat and mounting plate; save the package of screws, instructions and receipt.
- ☐ Remove cover from old thermostat. If it does not snap off when pulled firmly from the bottom, check for a screw used to lock on the cover.

- ☐ Loosen screws holding thermostat to subbase, wallplate or wall, and lift away.
- ☐ Disconnect wires from old thermostat or subbase. As you disconnect each wire, use masking tape to label it with the old terminal designation. If there are only two wires, they do not need to be labeled. If there is an extra wire that is not connected to your old thermostat, you will *also* not be connecting it to your new thermostat. Keep the wires from falling back into the wall by wrapping them around a pencil as shown.

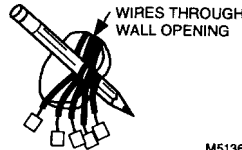

M5136

4

### Replacing a Clock Thermostat that has C or CI Clock Terminals?

If you are replacing a Honeywell Chronotherm® Thermostat, you may find one or two wires that go to the C or CI clock terminals on the Chronotherm Thermostat wiring wallplate. Do not allow them to touch, or you may damage your transformer. Disconnect the wires and wrap them separately, using electrical tape. *Do not wrap them together.* Place the wires where they will not interfere with the operation of the new thermostat. Record the colors and terminal designation labels of the remaining wires.

### Six or more wires?

If there are six or more wires (excluding clock wires attached to terminals), you most likely have a variation of a heat pump

or multistage system. The thermostat is *not* compatible with such systems so return the product to the place of purchase. If you would like information about which programmable thermostats will work with your system, call Honeywell Customer Assistance at 1-800-468-1502.

### Three thermostat wires?

If you have three wires for heating only and can operate the fan using the fan ON switch, this thermostat will work with your system. However, some hot water (zoned) heating systems have three thermostat wires. The thermostat will not work without installing an isolating relay on these systems. For details, call Honeywell Customer Assistance at 1-800-468-1502.

5

## STEP 3 Install The Batteries

**IMPORTANT:** Batteries must be installed for programming and operation of the thermostat and heating/cooling system.

- Purchase two AA alkaline batteries; non-alkaline batteries will not last as long, and may leak, causing damage to thermostat or wall surface. We recommend Energizer batteries.
- Make sure the thermostat is set in the OFF position.
- Use a coin to remove battery door.
- Install the fresh batteries as shown, making sure positive and negative terminals are oriented correctly.
- Replace battery door.

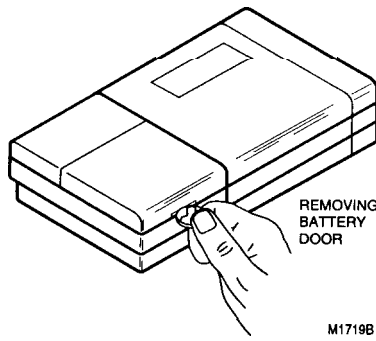

As the batteries are running low, a "bAt Lo" indicator will flash for one to two months before batteries run out completely. Replace the batteries as soon as possible after the indicator starts flashing. If you do not replace the batteries sometime during the flashing "bAt Lo," the indicator will eventually stop

6

flashing. "bAt Lo" will stay on without flashing, indicating the thermostat and heating/cooling system have stopped working and the batteries are almost completely dead. After the batteries are completely dead, the "bAt Lo" indicator will disappear, leaving a completely blank display.

Press down on left ends of batteries to remove. If you insert the new batteries within

20 to 30 seconds of removing the old ones, you will not have to reprogram the thermostat. However, if the display is blank, the batteries are dead or incorrectly installed, and you will have to reprogram. See pages 12 and 13 to reprogram.

**IMPORTANT:** Although the thermostat has a low battery indicator, replace the batteries once a year to prevent the thermostat and heating/cooling system from shutting down due to lack of battery power.

As a precaution, when leaving home for longer than a month, change batteries before you leave to prevent the system from shutting down due to lack of battery power.

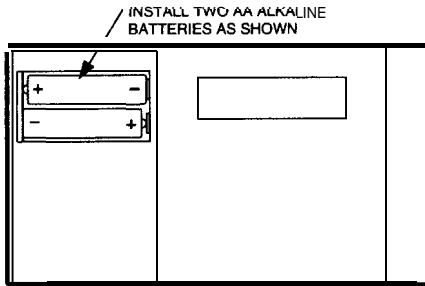

7

## STEP 4 Program The Thermostat

After the batteries are installed, the thermostat can be easily programmed in your hand before it is installed on the wall.

If you would prefer to program the thermostat after it is installed on the wall, skip to page 8, and return later to this programming section.

The following personal programming chart (pages 10 to 11) may be helpful for planning your program schedule of time and temperature settings for various times of the day.

Four time periods are available during weekdays — "WAKE," "LEAVE," "RETURN," and "SLEEP." These periods can be seen individually on the display as you press the SET SCHEDULE key.

"WAKE" is the time period you want the house at a comfortable temperature when you get up and while you get ready for work or school. (This will be a higher temperature during heating season, or a lower temperature during cooling season.)

"LEAVE" is the time period you can set for an energy-saving temperature while you are away at work or school. (This will be a lower temperature during heating season, or a higher temperature during cooling season.)

"RETURN" is the time period you want the house at a comfortable temperature for activities before bedtime. (Again, higher heat or lower cool.)

"SLEEP" is the time period you can set for an energy-saving temperature while you are

□

sleeping. (Again, lower heat or higher cool. For more comfortable sleeping, some people choose not to raise the cool temperature during the night.)

You will set one schedule for weekdays and another for weekends, because your requirements will probably be different for each. During weekends, only the "WAKE and "SLEEP time periods are available.

Fill in the times and temperatures you desire for weekdays and weekends. If you decide not to program the thermostat, it will automatically control heating at 68° F [20° C], and cooling at 78° F [26° C], 24 hours a day. Also, you do not need to enter a time and temperature program for all periods if your schedule does not

require it. For example, a house that is occupied during weekdays would only require programs for "WAKE and "SLEEP."

If no program is entered for the weekends, the thermostat will operate on the weekday "SLEEP program all weekend.

When pressing the keys, use the ball of your finger or a soft pencil eraser. Use of sharp fingernails or pencil points can damage the keypad.

If you make an error at any time during programming, just press the RUN PROGRAM key, and continue again at the step where you left off.

**PROGRAMMING**

9

**Personal Programming Chart**

**HEATING PROGRAM**

	Start Time	Heating Temperature <sup>2</sup>
<b>Weekdays</b>		
WAKE	_____	_____
LEAVE	_____	_____
RETURN	_____	_____
SLEEP	_____	_____
<b>Weekends <sup>1</sup></b>		
WAKE	_____	_____
SLEEP	_____	_____

<sup>1</sup> If you decide not to enter weekend programs, SLEEP from the weekday program will copy to the weekend schedule.

<sup>2</sup> The temperatures cannot be set any higher than 88° F [31° C] or any lower than 45° F [7° C].

10

**COOLING PROGRAM**

	Start Time	Cooling Temperature <sup>2</sup>
<b>Weekdays</b>		
WAKE	_____	_____
LEAVE	_____	_____
RETURN	_____	_____
SLEEP	_____	_____
<b>Weekends <sup>1</sup></b>		
WAKE	_____	_____
SLEEP	_____	_____

<sup>1</sup> If you decide not to enter weekend programs, SLEEP from the weekday program will copy to the weekend schedule.

<sup>2</sup> The temperatures cannot be set any higher than 88° F [31° C] or any lower than 45° F [7° C].

NOTE: If you decide not to program the thermostat, it will automatically control heating at 68° F [20° C], and cooling at 78° F [26° C], 24 hours a day.

**PROGRAMMING**

11

## COOLING PROGRAM

### Weekdays

WAKE

LEAVE

RETURN

SLEEP

### Start Time

\_\_\_\_\_

\_\_\_\_\_

\_\_\_\_\_

\_\_\_\_\_

### Cooling Temperature <sup>2</sup>

\_\_\_\_\_

\_\_\_\_\_

\_\_\_\_\_

\_\_\_\_\_

### Weekends <sup>1</sup>

WAKE

\_\_\_\_\_

\_\_\_\_\_

SLEEP

\_\_\_\_\_

\_\_\_\_\_

<sup>1</sup> If you decide not to enter weekend programs, **SLEEP** from the weekday program will copy to the weekend schedule.

<sup>2</sup> The temperatures cannot be set any higher than 88° F [31° C] or any lower than 45° F [7° C].

**NOTE:** If you decide not to program the thermostat, it will automatically control heating at 68° F [20° C], and cooling at 78° F [26° C], 24 hours a day.





## PROGRAMMING

11

This guide can be used for programming your new thermostat.

**NOTE:** Batteries are required for operation and programming. When inserting batteries, set system switch to OFF. Remove battery door (on thermostat left side) using a coin at the bottom. Follow instructions on pages 6 and 7.





### Set Current Time/Day

To set time, press and release  once,  until current time shows; to set day, press and release  again,  until current day shows; then press .

### Heating Program

With system switch at HEAT, press and release  once. "WAKE," Mon-Fri and "SET" appear on display.

12

Use  to program "WAKE time and  to program "WAKE" temperature for Mon-Fri. Repeat sequence for "LEAVE," "RETURN," "SLEEP." Press  until "WAKE," "SA SU" and "SET" appear on display. Use  to program "WAKE" time and  to program "WAKE" temperature for Sat-Sun. Repeat sequence for "SLEEP."

### Cooling Program

With system switch at COOL, follow the same instructions as for Heating Program.

After programming, adjust fan and system switches as desired. Press and release  to start the program.

## PROGRAMMING

13

A quick guide for operating or making changes follows:

**NOTE:** System switch must be set to Heat or Cool to perform the following:

**Temporarily Change Temperature for Current Period Only**—Temp  
Warmer  
Cooler  
Temporary indicator will

show on display; it will cancel itself at next scheduled change. To cancel sooner, press Run Program

**Hold a Temperature Indefinitely**—Hold Temp  
Warmer  
Cooler; press Run Program to cancel.

14

**Check Current Temperature Setting**—Run Program. (If using Temporarily Change or Hold, pressing this will cancel your change.)

**Check Programs**—Set Schedule repeatedly to see each time and temperature; then Run Program.

**Cancel a Program**—Set Schedule until program to cancel shows; then Ahead Back together.

**Permanently Change a Program**—Repeat steps under Heating Program or Cooling Program (pages 12 and 13) as applicable.

**Return to normal program or start program**—Run Program.

Questions?  
Call Honeywell  
Customer Assistance  
1-800-468-1502.

PROGRAMMING

15

## STEP 5 Adjust Fan Operation Switch, As Required

□ The thermostat fan operation switch, labeled FUEL SWITCH (see illustration on page 17) is factory-set in the "F" position. This is the correct setting for most systems. If your system is an

electric heat system, set the switch to "E". The "E" setting will allow the fan to turn on immediately with the heating or cooling in a system where the "G" terminal is connected.

## STEP 6 Adjust System On-Time, As Required

□ The system on-time is factory-set for a warm air, gas or oil heating system. If you are installing it on another type of system, the system on-time must be adjusted accordingly by setting screws A and B on the back of the thermostat. Use the heating system table shown in the illustration, (page 17) as a guide. The system on-time should be optimized according to the type of system to minimize room temperature swings. Setting the screw "out one turn" means turning the screw

approximately 360° counterclockwise, or about one complete turn.

In the unlikely event that you want longer furnace on-time, readjust screws A and/or B as follows:

First, turn both screws *in* completely, then adjust for system type:

- Warm Air Furnace—Set at the Hot Water setting, (A - out one turn, B - in).
- Electric Furnace—Leave at the Warm Air Furnace setting (A - in, B - in).

16

**NOTE:** This thermostat does not have a setting for steam/gravity air. Cycles would not be long enough for accurate temperature control.

**IMPORTANT:** When using a high efficiency furnace such as a 90 percent or greater Average Fuel Utilization Efficiency (AFUE) unit, adjust screw A OUT ONE TURN and screw B IN.

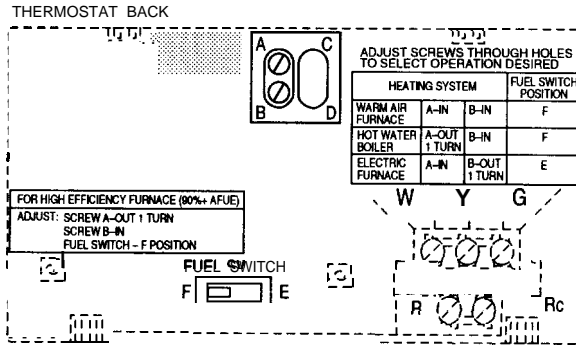

17

**INSTALLATION**

**STEP 7 Mount Thermostat Mounting Plate**

Position mounting plate on wall. Use a level to make sure mounting plate is level. Use a pencil to mark the two mounting holes.

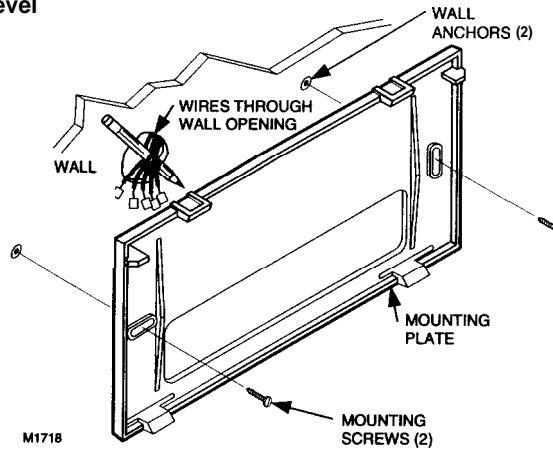

18

Remove mounting plate from wall, and drill 3/16 inch holes in wall (if drywall) as marked. For firmer material such as plaster or wood, drill 7/32 inch holes. Gently tap anchors (provided) into drilled holes until flush with the wall.

Reposition mounting plate over holes, pulling wires through wiring opening. Loosely insert two mounting screws into holes.

Level for appearance only; thermostat will function properly even when not level. Tighten mounting screws.

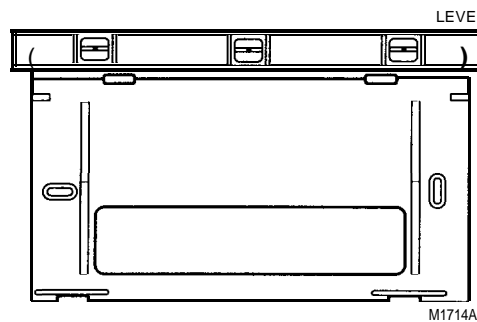

19

**INSTALLATION**



## STEP 8 Wire Thermostat Terminals

**NOTE:** All wiring must comply with local codes and ordinances. If unsure about household wiring procedures, call your local heating/air conditioning contractor.

Refer to masking tape labels you placed on wires when you removed your old thermostat.

- Match the letter of your old thermostat wire with the terminal of the corresponding letter on the back of your new thermostat. Refer to illustrations on pages 22 to 23. Hold the thermostat as shown to minimize need for wire extenders. If wires are still too short, use wire connect-

METHOD TO INCREASE WIRE LENGTH

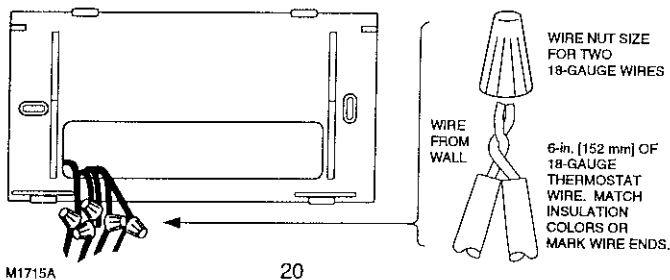

tors (purchased locally) to extend wires. See illustration (above) for guidelines on using wire extenders.

- In 5-wire installations only, be sure to remove the factory-installed jumper connecting terminals R and Rc.
- Loosen the terminal screws and slip each wire beneath its matching terminal. See illustration (lower right) for wire insertion technique. Tighten terminals securely.
- Plug the hole in the wall with insulation to help prevent drafts from adversely affecting thermostat operation.

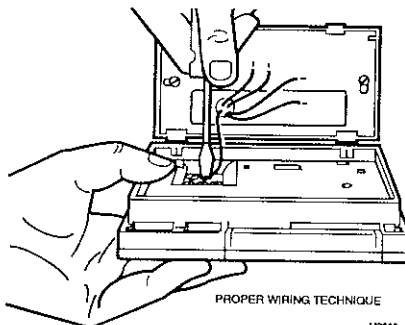

PROPER WIRING TECHNIQUE

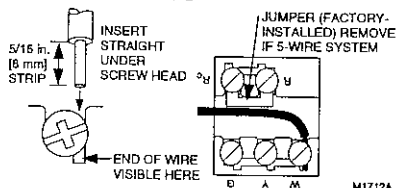

### 2-WIRE HEAT-ONLY (JUMPER INTACT)

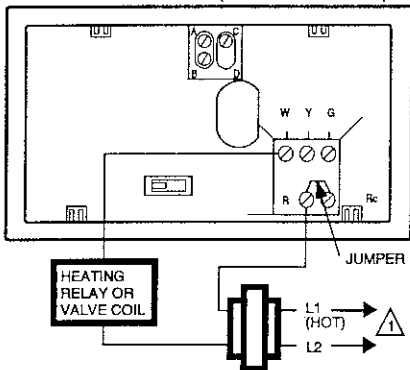

⚠ POWER SUPPLY. PROVIDE DISCONNECT MEANS AND OVERLOAD PROTECTION AS REQUIRED. M1709A

### 4-WIRE HEAT/COOL (JUMPER INTACT)

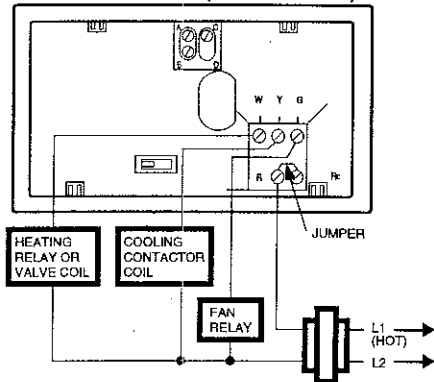

⚠ POWER SUPPLY. PROVIDE DISCONNECT MEANS AND OVERLOAD PROTECTION AS REQUIRED. M1710A

22

### 5-WIRE HEAT/COOL (JUMPER REMOVED)

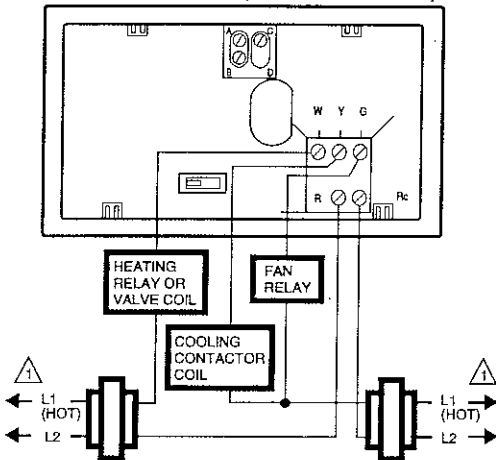

⚠ POWER SUPPLY. PROVIDE DISCONNECT MEANS AND OVERLOAD PROTECTION AS REQUIRED. M1711A

### 3-WIRE COOL-ONLY (JUMPER INTACT)

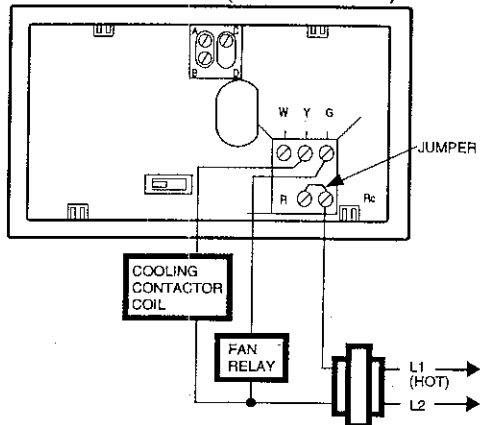

⚠ POWER SUPPLY. PROVIDE DISCONNECT MEANS AND OVERLOAD PROTECTION AS REQUIRED. M 848

## STEP 9 Mount The Thermostat

A. ENGAGE TABS AT TOP OF THERMOSTAT AND MOUNTING PLATE.

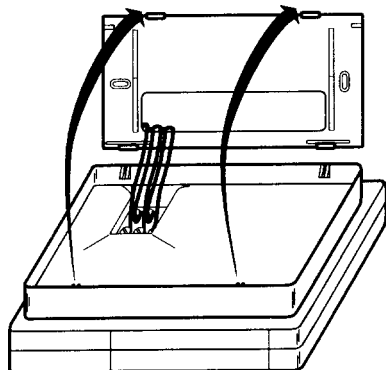

B. PRESS LOWER EDGE OF CASE TO LATCH.

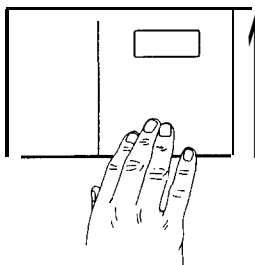

C. SWING COVER OPEN TO CHECK OPERATION.

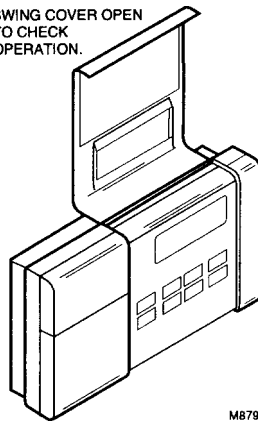

NOTE: To remove thermostat from wall, first pull out at bottom of thermostat, removing top last. 24

## STEP 10 Check Thermostat Operation After Programming And Installing

### HEATING

Do *not* check heating system operation by jumpering thermostat terminals at the primary control such as the gas valve, zone valve, or oil burner control. This will damage the thermostat. Instead, jumper R and W wires at the thermostat.

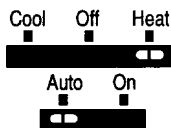

Move the system switch to HEAT and the fan switch to AUTO.

Temp  
Warmer  
C 1

Press key until the setting is about 10° F [6° C] above room temperature. Heating should start and the fan should run after a short delay (immediately if fan operation switch is set in E position).

Temp  
Cooler

Press key until setting is about 10° F [6° C] below room temperature. The heating equipment should shut off.

25

INSTALLATION

## COOLING

To avoid possible compressor damage, do not operate the cooling system when outside temperature is below 50° F [10° C]. See compressor manufacturer instructions for further information.

NOTE: When cooling setting is changed, thermostat may delay up to five minutes before turning on the air conditioner. This delay protects the compressor.

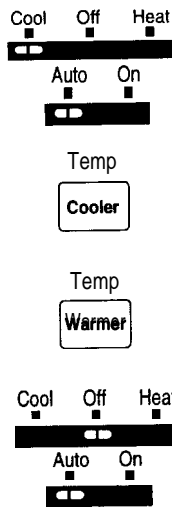

Move the system switch to COOL and the fan switch to AUTO.

Press key until setting is about 10° F [6° C] below room temperature. The cooling equipment and fan should start.

Press key until the setting is about 10° F [6° C] above room temperature. The cooling equipment and fan should stop.

Move the system switch to OFF with the fan switch still at AUTO. The system and fan should be off.

26

## STEP 11 Set The Fan And System Switches

First set the fan switch.

**FAN AUTO:** Normal setting for most homes. A single-speed fan will turn on automatically with air conditioner or furnace. A two-speed fan will usually run on high with air conditioner and on low with furnace.

**Exception:** When Fan Operation Switch on back of thermostat is set to "E" position (see page 16), fan will operate with furnace only.

**FAN ON:** The fan runs continuously. Use for improved air circulation during special occasions or for more efficient electronic air cleaning. (In a heat-only system, fan will run continuously only when fan relay is connected to the thermostat.)



27

## INSTALLATION

Then set the system switch.

**COOL:** The thermostat controls your air conditioning system.



**OFF:** Both the heating and air conditioning systems are off.



**HEAT:** The thermostat controls your heating system.



28

# Troubleshooting Guide

## IF...

Display will not come on.

Temperature display will not go lower than 45° F [7° C] or higher than 88° F [31° C] during programming.

Temperature change occurs at the wrong times.

Heating will not come on.

## THEN...

- Set the system switch to **OFF. Remove batteries. Insert batteries backward** for at least five seconds to reset thermostat. Replace batteries correctly. Display should come on.
- Make sure batteries are fresh and installed correctly.
- Gently clean battery contacts using a soft pencil eraser. Do not use anything abrasive on clips.
- You have reached the temperature setting limit.
- The setting range is 45° F to 88° F [7° C to 31° C].
- Check the program times for the period in question. Be sure that AM and PM indications are correct. Make sure the current day and time are correct. Reprogram if necessary.
- Check that switch on thermostat is set to HEAT.

29

---

Heating will not come on (*continued*). ■ Check the system fuse or circuit breaker and replace or reset if necessary.

- Check for correct wiring and good connections.
- Jumper wires R and W. If heat does not come on, contact your heating dealer.
- If display is blank or says "bAt Lo," install fresh batteries.
- If temperature setting is higher than current temperature, and SYSTEM ON indicator is lit, contact Honeywell Customer Assistance at 1-800-468-1502.

Cooling will not come on.

- Check that switch on thermostat is set to COOL.
- Check the system fuse or circuit breaker and replace or reset if necessary.
- Check for correct wiring and good connections.
- Jumper wires R<sub>c</sub> and Y. If cooling does not come on, contact your cooling dealer.
- If display is blank or says "bAt Lo," install fresh batteries.
- The thermostat has a built-in time delay on cooling. Allow five to ten minutes after changing the setting before the air conditioner starts.

30

- Make sure outdoor disconnect is engaged (on).
- If temperature setting is lower than current temperature, and SYSTEM ON indicator is lit, move system switch from COOL to OFF for ten minutes. After ten minutes, return switch to COOL position. If air conditioner comes on, compressor may have reached its high limit temperature protection and shut down. If air conditioner does not come on after the ten minutes and the SYSTEM ON indicator is lit, contact Honeywell Consumer Assistance at 1-800-468-1502.
- If 2- or 4-wire installation, **verify that R-R<sub>c</sub> jumper is installed.**

The house is too warm or too cool.

- Press RUN PROGRAM key to check the current temperature setting.
- If desired, change the temperature setting. See page 14.

SYSTEM ON indicator is lit, but no heat is coming from the registers.

- Allow time for the furnace to heat up and the fan to come on before checking for heat at the register. (Check to make sure system on-time is set correctly according to pages 16 and 17.)

31

The furnace cycles too frequently, or the system cycle length is too short or too long.

The thermostat current setting does not match the display temperature to within  $\pm 10$ .

Incorrect room temperature showing on thermostat display.

- Readjust system on-time according to instructions on pages 16 and 17.
- Check that the wiring hole in the wall behind the wallplate has been plugged with insulation to prevent drafts that might adversely affect thermostat operation.
- Be aware that it is normal for the current setting and display temperature to differ on occasion.
- During recovery from setback or setup, setting and display temperatures may differ for up to 30 minutes after the recovery period.
- Make sure hole behind thermostat is plugged with insulation to help prevent drafts from adversely affecting thermostat operation.
- The thermostat is factory-calibrated, and cannot be adjusted.

32

#### Toll-free Customer Assistance

For all questions concerning this thermostat, please read and follow the instructions. If additional assistance is needed, call Honeywell Customer Assistance toll-free at 1-800-468-1502, Monday-Friday, 7:00 a.m. -5:30 p.m. Central time.

Before you call, please have the following information available: thermostat model number and date code, kind of heating/cooling system (i.e., hot water, warm air, oil, gas, etc.), and number of wires connected to the thermostat.

#### NOTICE

This equipment is a Class B digital apparatus, which complies with Canadian Radio Interference Regulations, CRC c. 1374.

33

## Free Manuals Download Website

<http://myh66.com>

<http://usermanuals.us>

<http://www.somanuals.com>

<http://www.4manuals.cc>

<http://www.manual-lib.com>

<http://www.404manual.com>

<http://www.luxmanual.com>

<http://aubethermostatmanual.com>

Golf course search by state

<http://golfingnear.com>

Email search by domain

<http://emailbydomain.com>

Auto manuals search

<http://auto.somanuals.com>

TV manuals search

<http://tv.somanuals.com>