

GB

English

### TVEL 75 Experience

## Contents

### Important information, 2

### Product data, 2

### Installation, 3-4

Where to put your dryer  
Ventilation  
Electrical connection  
Levelling your dryer  
Before you start using your dryer

### Dryer description, 5

The front  
The back  
Control panel

### Start and programmes, 6-10

Choosing a programme  
Tables of Programmes  
The controls

### Laundry, 11-12

Sorting your laundry  
Wash care labels  
Special clothing items  
Drying times

### Warnings and Suggestions, 13

General safety  
Saving energy and respecting the environment

### Maintenance and Care, 14

Switching off the electricity  
Cleaning the filter after each cycle  
Check the drum after each cycle  
Cleaning the dryer

### Troubleshooting, 15

### Service, 16

Disposal

### Hotpoint Guarantee, 19

### Hotpoint After Sales Service, 20

! Keep this instruction booklet on hand in order to refer to it when necessary. Take it with you when you move, and should you sell this appliance or pass it on to another party, make sure that this booklet is supplied along with the dryer so that the new owner may be informed about warnings and suggestions on how the appliance works.

! Read these instructions carefully; the following pages contain important information on installation and suggestions on how the appliance works.



This symbol reminds you to read this booklet.

 **Hotpoint**

GB

Important  
Information

Installation

Description

The Display

Start and  
Programmes

Laundry

Warnings and  
Suggestions

Maintenance  
and Care

Troubleshooting

Service

# Important Information

GB

For your Venting dryer to operate efficiently, you must follow the regular maintenance schedule shown below:

## Fluff Filter...

**!** You MUST clean the fluff filter after EVERY drying cycle.

### STEP 1.

Open the door of your dryer.



### STEP 2.

Pull out the filter (using the two finger grips).

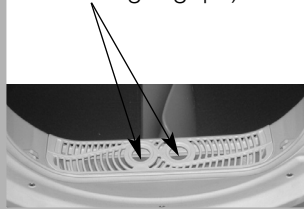

### STEP 3.

Open the filter and clean any fluff deposits from the filter mesh.

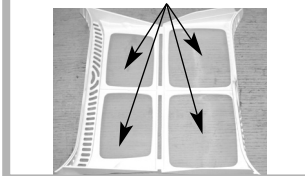

### STEP 4.

Refit the filter, with the curved side towards you.



### STEP 5.

Make sure the filter is pushed fully home.  
- NEVER run the dryer without the filter in position.

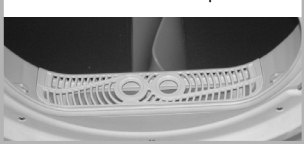

**!** Failure to clean the filter after EVERY drying cycle will affect the drying performance of your machine.

- It will take longer to dry and as a result will use more electricity during drying.

**!** You MUST clean fluff build up around the filter housing and the vent tube periodically, EVERY two or three months:

- Check the vent tube and any permanent venting fixture to make sure that there has been no accumulation of fluff or lint, and remove it.
- Remove lint that collects around the filter and the outlet vents.

## Product Data... (EU Regulation 392/2012)

Rated capacity of Cotton laundry for the standard programme at full load <b>7 kg</b>	Energy efficiency class <b>B</b>
The weighted Annual Energy Consumption ( $AE_c$ ) <b>471.7 kWh</b> Consumption per year, based on 160 drying cycles of the standard cotton programme at full and partial load, and the consumption of the low-power modes. Actual energy consumption per cycle will depend on how the appliance is used.	
This household tumble dryer is a <b>Automatic Air-Vented Dryer</b>	
Energy consumption : full load $E_{dry}$ <b>4.04 kWh</b> , partial load $E_{dry1/2}$ <b>2.12 kWh</b>	
Power consumption : off-mode ( $P_o$ ) <b>0.14 W</b> , left-on mode ( $P_l$ ) <b>1.96 W</b>	
Duration of the 'left-on mode' for power management systems <b>30</b> minutes	
The 'standard cotton programme' suitable for drying normal wet cotton laundry that is the most efficient programme in terms of energy consumption for cotton used at full and partial load is <b>Cottons - Cupboard Dry</b>	
Programme time (minutes) : weighted ( $T_l$ ) full & partial load <b>84</b> , full load ( $T_{dry}$ ) <b>115</b> , partial load ( $T_{dry1/2}$ ) <b>60</b>	
Airborne acoustical noise emissions <b>69 dB(A) re 1 pW</b>	

This data is also available on the website <http://www.hotpoint.eu/hotpoint/>

## Where to put your dryer

- Place your dryer at a distance from gas ranges, stoves, heaters, or cook tops because flames can damage the appliance.

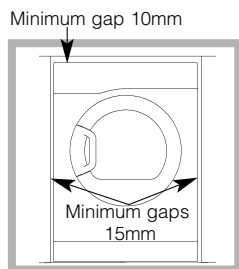

- If you are going to install the appliance under a work counter, be sure to leave a 10mm space between the top and any other objects on or above the machine and a 15mm space between the sides and lateral furnishings or walls. This is to ensure

proper air circulation. Make sure that the back vents are not obstructed.

- Make sure you put your dryer in an environment that is not damp and has proper air circulation throughout, the dryer will not operate efficiently in an enclosed space or cupboard.

! We do not recommend that the dryer is installed in a cupboard but the dryer must never be installed behind a lockable door, a sliding door or a door with a hinge on the opposite side to that of the dryer door.

## Ventilation

The Dryer dries your laundry by drawing in cool, clean and relatively dry air, heating it, and then distributing it through the clothes as they are gently tumbled. For optimum performance, the moist air is then blown out through a vent tube at the back of the dryer.

When the dryer is in use, there has to be adequate ventilation to avoid the back flow of gases into the room from appliances burning other fuels, including open fires.

### Mobile venting

A vent tube must always be fitted when the dryer is used in conjunction with Mobile Venting. The tube must be fitted securely into the back of the dryer (*see Dryer Description*). If possible, it is always best to connect the tube to a permanent outlet close to the dryer. If permanent installation is not possible, the dryer will work just as well with the tube passing through a partly-opened window.

! Ensure that the end of the tube is not directed toward the air intake vent at the rear of the dryer.

! The vent tube should not exceed 2.4 metres in length and should be kept free of any possible accumulation of fluff, lint and water by shaking it out frequently. Always ensure that the tube is not squashed.

## Permanent venting

In conjunction with the vent tube we recommend using a Wall/Window Vent Kit, available at a retail location or the nearest Spare Parts Dealer.

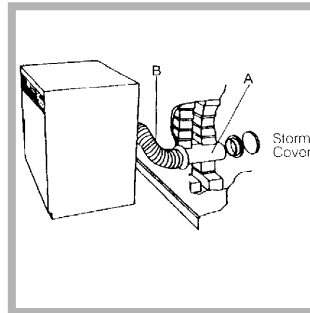

### Wall mounting

1. Leave an opening in the wall to the left of the dryers proposed position.
2. Keep the tube as short and straight as possible to prevent condensed moisture from backing up into the dryer.
3. Similarly, the duct in the wall should slope downwards towards the outside.

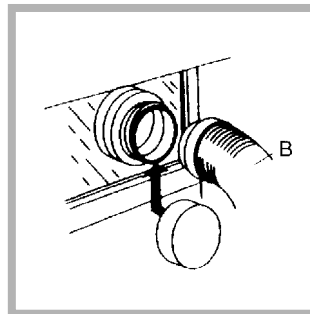

### Window mounting

1. With a stacked dryer the hole in the window should ideally be made below the vent.
2. The tube should be kept as short as possible.

Depending on how often you use your dryer, it is essential that areas A and B are checked periodically to remove lint or debris.

The vent tube adaptor must be fitted securely thus preventing any humid air from being emitted back into the room.

! The Dryer should not be pushed so far back that the tube adaptor is pulled out of position or the tube is squashed or bent.

! The tube should be kept clear of the air intake vent and kinks or 'U' bends must be avoided as these will obstruct the tube or trap condensation.

GB

Important Information

Installation

Description

The Display

Start and Programmes

Laundry

Warnings and Suggestions

Maintenance and Care

Troubleshooting

Service

# Installation

GB

## Open window venting

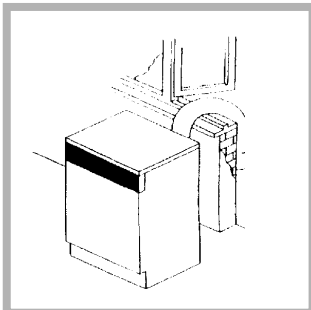

The end of the tube should be directed downwards, to prevent warm moist air from condensing in the room or in the dryer.

! Ensure that the dryer is adequately ventilated and that the end of the vent tube is not directed towards the air intake duct.

! The vent tube must always be fitted for optimum performance.

! Make sure that the vent tube and air intake vents are not obstructed or blocked.

! The dryer must not recycle exhaust air.

! Misusing a tumble dryer may create a fire hazard.

! Do not discharge exhaust air into a flue which is used for exhaust fumes from other appliances that burn gas or other fuels.

! Do not discharge exhaust air into an extraction system or any duct with an extractor fan. This will affect the way the thermal controls operate and can result in a fire hazard.

## Electrical connections

Make sure of the following before you insert the plug into the the electrical socket:

- The socket must be grounded.
- The socket must be able to sustain the machines maximum power, which is indicated on the rating label (*see Dryer Description*).
- Power voltage must be within the values indicated on the rating label (*see Dryer Description*).
- The socket must be compatible with the dryers plug. Should this not be the case, replace the plug or the socket.

! The dryer must not be installed outdoors, even if the space is sheltered. It can be very dangerous if it is exposed to rain or storms.

! Once installed, the dryers electrical wire and plug must be within easy reach.

! Do not use extension cords.

! The power cord must not be bent or squashed.

! The power cord supplied is fitted with a BS1363 plug and a 13 amp BS1362 fuse. If you need to replace the fuse, use only those rated at 13 amp (13A) and ASTA approved to BS1362.

## Moulded plug

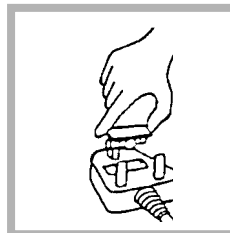

! The plug must not be used without the fuse cover in place. If a replacement fuse holder/cover is required, it must be of the same colour coding or wording as shown on the base of the plug. Replacements are available from authorised dealers.

## Changing the plug

The wires in the power cord are coloured in accordance with the following:

Green and Yellow (Earth) wire to terminal marked 'E', symbol  $\perp$ , or coloured green and yellow.

Blue (Neutral) wire to terminal marked 'N' or coloured black.

Cord clamp

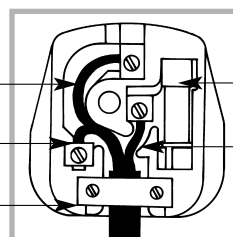

13A ASTA approved fuse to BS1362.

Brown (Live) wire to terminal marked 'L' or coloured red.

! If the plug being replaced is a non-rewirable type, then the cut-off plug must be disposed of safely. DO NOT leave it where it can be inserted into a socket and create a shock hazard.

! The power supply cord should be checked periodically and replaced by a cord specially prepared for this dryer and fitted only by authorised technicians (*see Service*). New or longer power cords are supplied at an extra charge by authorised dealers.

! The manufacturer denies any responsibility should any of these rules not be followed.

! If in doubt about any of the above consult a qualified electrician.

## Levelling your dryer

The dryer must be installed level for correct operation.

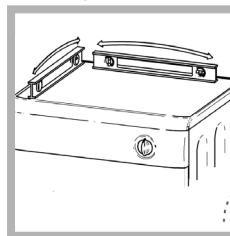

When you have installed your dryer in its final location check that it is level first side to side, then front to back.

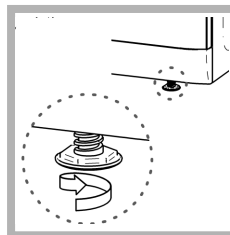

If the dryer is not level, use a wooden block to support it while adjusting the two front legs up or down, until your dryer is level.

## Before you start using your dryer

Once you have installed your dryer and before you use it, clean the inside of the drum to remove any dust that could have accumulated during transport.

# Dryer Description



## The front

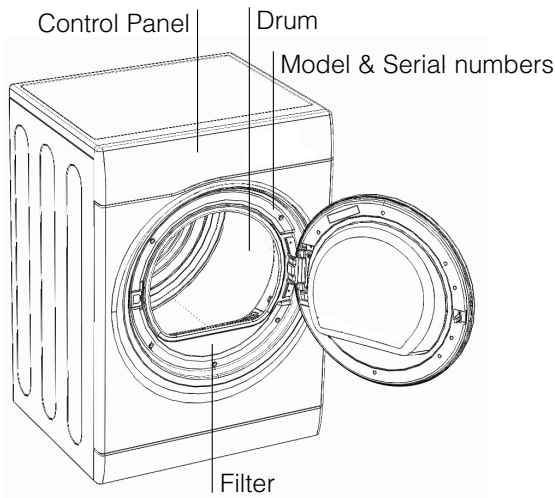

## The back

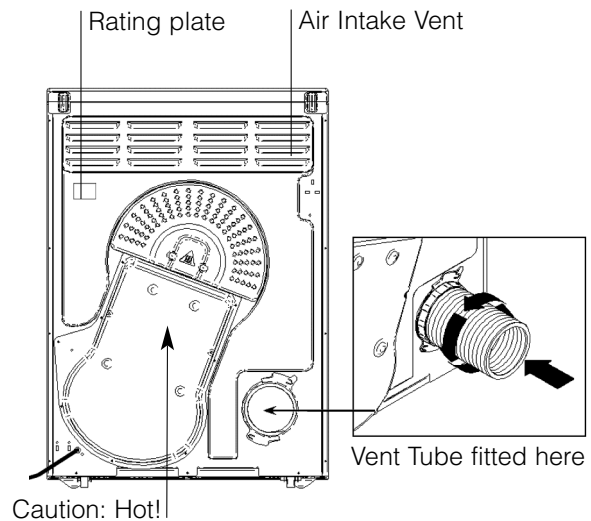

## Control panel

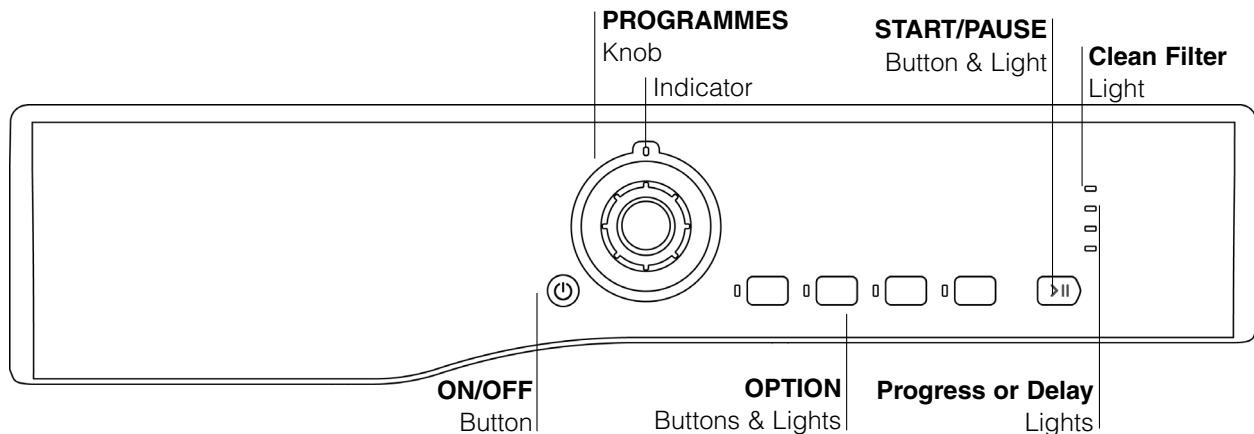

The **ON/OFF** button  : If the dryer is running and this button is pressed and held for more than 3 seconds, the dryer is turned off. Press and hold again for more than 3 seconds and the dryer reactivates.

The **PROGRAMMES** knob sets the programme: rotate it until the indicator is pointing to the programme you want to select (*see Start and Programmes*).

The **OPTION** buttons/lights select available options for your selected programme. The lights indicate that the option has been selected. If an option is not available the buzzer will beep three times (*see Start and Programmes*).

The **START/PAUSE** button/light  starts a selected programme. When you press this button there will be one beep and the progress lights will flash to confirm the action. When a programme is running, holding this

button in pauses the programme and stops the dryer. The light is green when programme is running, flashing amber if the programme has been paused or flashing green if on standby waiting to start a programme (*see Start and Programmes*).

**Note:** This light also flashes amber during the Post Care phase of a programme.

The **Progress or Delay** lights show you the status of the programme, or the delay time when they flash. During a delayed start the lights flash to show the delay selected. When (not flashing) they show each stage of the programme by the corresponding light turning on (*see Start and Programmes*).

The **Clean Filter** light gives you a reminder before every programme that it is essential to clean the filter every time the dryer is used (*see Maintenance and Care*).

GB

Important Information

Installation

Description

The Display

Start and Programmes

Laundry

Warnings and Suggestions

Maintenance and Care



Troubleshooting

Service

# Start and Programmes

GB

## Choosing a programme

1. Plug the dryer into the electrical socket.
2. Sort your laundry according to fabric type (*see Laundry*).
3. Open the door and make sure the filter is clean and in place (*see Maintenance*).
4. Load the machine and make sure items are not in the way of the door seal. Close the door.
5. If none of the lights are on: Press the ON/OFF button .
6. Choose a programme by checking the Programmes Guide (*see Programmes*) as well as the indications for each type of fabric (*see Laundry*).
  - Select a programme by rotating the PROGRAMMES knob.
7. Set a delay time and other options if necessary.
8. The START/PAUSE light is flashing green:
  - press the START/PAUSE  button to begin. The green light stops flashing.During the drying programme, you can check on your laundry and take out items that are dry while others continue drying. When you close the door again, press the START/PAUSE button in order to resume drying.  
*(When the door is opened the START/PAUSE light will flash Amber, after the door is closed and the START/PAUSE button pressed, the START/PAUSE light will stop flashing and show green.)*  
**Note:** During the Post Care phase this light flashes Amber.
9. At the end of the drying cycle the End light comes on and either :
  - The buzzer will beep 3 times to let you know that your programme is complete. (**Note:** If the SOUND option was selected the buzzer beeps 3 times every 30 seconds for 5 minutes).
  - or - If you have selected the Crease Care option and you do not take the items out immediately, the items will tumble occasionally for 10 hours or until you open the door, the buzzer will then beep 3 times to confirm the programme is completed.
10. Open the door, take the laundry out, clean the filter and replace it (*see Maintenance*).
11. Unplug the dryer.

### Note:

This tumble dryer, in compliance with new energy saving regulations, is fitted with an automatic standby system which is enabled after about 30 minutes if no activity is detected. Press the ON/OFF button briefly and wait for the dryer to reactivate.

### Shirts Light Dry High heat option

- This is a programme for shirts made from cotton.
- It can be used for load sizes up to 3kg (approximately 10 shirts).
- This programme will take about 60 minutes, but may take longer depending on the size of the load and the spin speed used in your washer.

#### Low heat option

- This is a programme for shirts made from synthetic materials or a mixture of natural and synthetic materials, such as polyester and cotton.
- It can be used for load sizes up to 3kg (approximately 14 shirts).
- This programme will take about 55 minutes, but may take longer depending on the size of the load and the spin speed used in your washer.

Shirts dried using this programme are usually ready to put away, the edges or seams may be slightly damp. If this is the case, try turning the shirts inside out and running the programme again for a short period.

### Jeans

- This is a programme for jeans made from denim cotton. Before drying your jeans turn the front pockets inside out.
  - It can be used for load sizes up to 3kg (approximately 4 pairs).
  - Do not mix dark and light coloured items.
  - It can also be used on other garments made from the same material, such as jackets.
  - This programme will take about 85 minutes, but may take longer depending on the size of the load and the spin speed used in your washer.
  - Loads dried using this programme are usually ready to wear, the edges or seams may be slightly damp. If this is the case, try turning the jeans inside out and running the programme again for a short period.
- ! We do not recommend that you use this programme if your jeans have elastic waist bands, studs or embroidery.

## Wool Programme

- This is a programme for tumble dryer safe garments marked with the symbol .
- It can be used for load sizes up to 1kg (approximately 3 sweaters).
- We recommend that garments are turned inside out before drying.
- This programme will take about 60 minutes, but may take longer depending on the size and density of the load and the spin speed used in your washer.
- Loads dried using this programme are usually ready to wear, but on some heavier garments the edges may be slightly damp. Allow these to dry naturally as over-drying could damage garments.

! Unlike other materials, the mechanism of wool shrinkage is irreversible; i.e. it will not stretch back to original size and shape.  
! This programme is not suitable for Acrylic garments.

## Baby Delicate Programme

- This is a programme for drying your baby's small delicate items of clothing and bedding (Cotton and Chenille) and for drying your delicate clothes.
- DO NOT dry items such as bibs and nappy pants with plastic coverings.
- It can be used for load sizes up to 2kg.
- This programme will take about 60 minutes, but may take longer depending on the size and density of the load and the spin speed used in your washer.
- Loads dried using this programme are usually ready to wear, but on some heavier garments the edges may be slightly damp. If this is the case, try turning items inside out and running the programme again for a short period.

## Bed & Bath

- This is a programme for Cotton Towels and sheets.
- It can be used on any load size, do not overload your dryer (*see Laundry*).
- This programme will take about 100 minutes, but may take longer depending on the the size and density of the load and the spin speed used in your washer.
- Loads dried using this programme are usually ready to use, the edges or seams may be slightly damp, especially on large items. If this is the case, try opening them out and running the programme again for a short period.

## Heat & Enjoy

This programme helps to heat towels & bathrobes for a warm sensation after a bath or shower. It is also useful for warming clothes before dressing during winter. The cycle heats clothes to 37°C (Body Temperature) and runs at this temperature for a maximum of 4 hours or until you stop the cycle by opening the door.  
Maximum load 3kg.

## Easy Iron Programme

'Easy Iron' is a short 10 minute programme (8 minutes of heat followed by a 2 minute cool tumble period) which fluffs the fibres of clothing that have been left in the same position/location for an extended period of time. The cycle relaxes the fibres and makes them easier to iron and fold.

! 'Easy Iron' is **not a drying programme** and should not be used for wet articles of clothing.

For best results: 1. Do not load more than the maximum capacity. These numbers refer to the dry weight:

Fabric	Maximum load
Cotton and Cotton mixtures	2.5kg
Synthetics	2kg
Denim	2kg

2. Unload the dryer immediately after the end of the programme, hang, fold or iron the articles and put them away in the closet. Should this not be possible repeat the programme.

The 'Easy Iron' effect varies from one fabric to the next. It works well on traditional fabrics like Cotton or Cotton mix, and less well on acrylic fibres and on materials such as Tencel®.

## Refresh

! 'Refresh' is **not a drying programme** and should not be used for wet articles of clothing.

- It can be used on any load size, but is more effective on smaller loads.
- Do not overload your dryer (*see Laundry*).
- This is a 20 minute programme that airs your clothes with cool air. Also use to cool warm clothes.

GB

Important Information

Installation

Description

The Display

Start and Programmes

Laundry

Warnings and Suggestions

Maintenance and Care

Troubleshooting







Service

# Start and Programmes

GB

## Programmes

! If none of the lights are lit; Press the ON/OFF button  and then select programme.

<i>Programme</i>	<i>What it does...</i>	<i>How to set it...</i>	<i>Notes/Options available:</i>
<b>1</b> <b>Cottons</b> Ready to wear 	Dries your clothes, ready for wearing.	1. Position the PROGRAMME knob on <b>1</b> . 2. Select any Options, if required. 3. Press the Start/Pause button <b>&gt;  </b> .	Delay Timer Crease Care or Sound
<b>2</b> <b>Cottons</b> Cupboard Dry 	Dries your clothes, ready for putting away.	1. Position the PROGRAMME knob on <b>2</b> . 2. Select any Options, if required. 3. Press the Start/Pause button <b>&gt;  </b> .	Delay Timer High Heat Crease Care or Sound
<b>3</b> <b>Cottons</b> Hanger Dry 	Dries your clothes, ready for hanging.	1. Position the PROGRAMME knob on <b>3</b> . 2. Select any Options, if required. 3. Press the Start/Pause button <b>&gt;  </b> .	Delay Timer High Heat Crease Care or Sound
<b>4</b> <b>Cottons</b> Iron Dry 	Dries your clothes, ready for ironing.	1. Position the PROGRAMME knob on <b>4</b> . 2. Select any Options, if required. 3. Press the Start/Pause button <b>&gt;  </b> .	Delay Timer High Heat Crease Care or Sound
<b>5</b> <b>Shirts</b> Light Dry 	Dries your Cotton or Synthetic shirts, ready for putting away.	1. Position the PROGRAMME knob on <b>5</b> . 2. Select any Options, if required. 3. Press the Start/Pause button <b>&gt;  </b> .	Delay Timer High Heat Crease Care or Sound
<b>6</b> <b>Synthetics</b> 	Dries your Synthetic clothes, ready for putting away.	1. Position the PROGRAMME knob on <b>6</b> . 2. Select any Options, if required. 3. Press the Start/Pause button <b>&gt;  </b> .	Delay Timer Crease Care or Sound



# Start and Programmes

## Programmes Table

! If none of the lights are on; Press the ON/OFF button and then select programme.

### EXCLUSIVES

Programme	What it does...	How to set it...	Notes/Options available:
<b>7</b> <b>Jeans</b>	Dries your Cotton Jeans.	1. Position the PROGRAMME knob on <b>7</b> . 2. Select any Options, if required. 3. Press the Start/Pause button <b>&gt;  </b>	Delay Timer Crease Care or Sound
<b>8</b> <b>Wool</b>	Dries your Woollen clothes, ( <i>see previous pages</i> ).	1. Position the PROGRAMME knob on <b>8</b> . 2. Press the Start/Pause button <b>&gt;  </b>	Sound
<b>9</b> <b>Baby Delicates</b>	Dries your clothes on Low heat setting, ready to be worn.	1. Position the PROGRAMME knob on <b>9</b> . 2. Select any Options, if required. 3. Press the Start/Pause button <b>&gt;  </b>	Delay Timer Crease Care or Sound
<b>10</b> <b>Bed &amp; Bath</b>	Dries your Bedding & Towels on High Heat setting, ready for putting away.	1. Position the PROGRAMME knob on <b>10</b> . 2. Select any Options, if required. 3. Press the Start/Pause button <b>&gt;  </b>	Delay Timer Crease Care or Sound

### TIMED DRY

Programme	What it does...	How to set it...	Notes/Options available:
<b>Timed Drying</b> 	Always use timed drying for loads of less than 1kg. The heat setting used depends on the fabric that is being dried ( <i>see laundry</i> ).	1. Position the PROGRAMME knob on either <b>11</b> . for 30 minute programme or <b>12</b> . for 60 minute programme or <b>13</b> . for 140 minute programme or 2. Select any Options, if required. 3. Press the Start/Pause button <b>&gt;  </b>	Delay Timer High Heat Crease Care or Sound  • The last 10 minutes of these programmes is the cool tumble phase

### EXTRA

Programme	What it does...	How to set it...	Notes/Options available:
<b>14</b> <b>Heat &amp; Enjoy</b>	Warms towels, bathrobes or other clothes	1. Position the PROGRAMME knob on <b>14</b> . 2. Press the Start/Pause button <b>&gt;  </b>	None
<b>15</b> <b>Easy Iron</b>	Brief programme (approximately 10 minutes) that softens fibres of clothing that is ready for ironing.	1. Position the PROGRAMME knob on <b>15</b> . 2. Press the Start/Pause button <b>&gt;  </b>	Sound  ! This is not a drying programme ( <i>see previous pages</i> ).
<b>16</b> <b>Refresh</b>	20-minute programme that airs your clothes with cool air. Use also to cool warm clothes.	1. Position the PROGRAMME knob on <b>16</b> . 2. Press the Start/Pause button <b>&gt;  </b>	Sound

# Start and Programmes

GB

## The Controls

### • PROGRAMMES knob

**! Warning**, if after pressing the start button, the programmes knob position is changed, the new position will **NOT** change the programme selected.

To change a selected programme, press the Start/Pause button **>||**, the light flashes Amber to indicate the programme is paused. Select the new programme and any options required, the light will then flash green. Press the Start/Pause button **>||** again and the new programme will start.

### • OPTION buttons / lights

These buttons are used to customise the selected programme to your requirements. Not all options are available for all programmes (*see Start and Programmes*). If an option is not available and you press the button, the buzzer will beep three times. If the option is available the option light next to the button lights to confirm the selection.

### Progress (☀-Drying, 🌀 Cool Tumble, End) / Delay (3hr 6hr 9hr) Lights

When the light next to the delay button is on, these lights flash to indicate the delay time selected. During other programmes they indicate the progress of the dryer, each one comes on as the corresponding phase starts.

### Delay Timer (Time Delay)

The start of some programmes (*see Start and Programmes*) can be delayed for up to 9 hours in 3hr steps.

When a delayed start is in progress the light next to the delay button will be on and the selected delay period light will flash (after the start button has been pressed). To set a delayed start, press the Delay Timer button, and the light next to the button will come on together with the 3hr delay light. Pressing the button again will advance the delay setting to 6hr, the 3hr light goes out and the 6hr light is on. Each time you press the button the delay setting advances 3 hours, as indicated by the corresponding light. If the 9hr light is on, pressing the button again will cancel the delay. Holding in the On/Off button will also cancel.

### Crease Care

The *pre-care option* is only available if a delayed start has been selected. It tumbles the clothes occasionally during the delayed period to help prevent creases developing. The *post-care option* occasionally tumbles the clothes after the end of the drying and cool tumble cycles to prevent creases developing, should you not be available to remove the load immediately the programme is complete. The End light is on during this phase. **Note:** The Start/Pause light flashes Amber during this phase. Selecting this option enables both the pre and post care functions if appropriate.

**Note:** If you have selected the Sound option this option is not available.

### High Heat

Press this button and a high heat setting is selected and the light next to the button comes on. If the light alongside the button is on then pressing the button selects a low heat setting and the light goes out. Not all programmes allow you to change this setting.

### Sound

If selected, gives a signal at the end of the drying cycle, to remind you that the clothes are ready to be removed. Not available with the Heat & Enjoy programme.

**Note:** If you have selected the Crease Care option this option is not available.

### • Door Opening

Opening the door (or pressing the Start/Pause button) during a programme will stop the dryer and have the following effects:

**Note:** The Start/Pause light flashes Amber during the Post Care phase of a programme.

- The Start/Pause light flashes Amber.
- During a delay phase the delay will continue to count down. The Start/Pause button **must** be pressed to resume the delay programme. One of the delay lights will flash to show the current delay setting.
- The Start/Pause button **must** be pressed to resume the programme. The progress lights will change to show the current status and the Start/Pause light will stop flashing and turn green.
- During the Post Care phase of a drying programme, the programme will finish. Pressing the Start/Pause button will re-start a new programme at the beginning.
- Changing the programmes knob will select a new programme and the Start/Pause light will flash green. You can use this to select the Refresh  programme to cool the clothes, if you find them dry enough. Press the Start/Pause button to begin a new programme.

### • Note

If you have a power cut, switch off the power or remove the plug, press and hold the On/Off button until the dryer reactivates, then press the Start/Pause button.

## Sorting your laundry

- Check symbols on clothing labels to make sure that the articles can be tumble dried.
- Sort laundry by fabric type.
- Empty pockets and check buttons.
- Close zippers and hooks and tie loose belts and strings.
- Wring out each item in order to eliminate as much excess water as possible.

! Do not load dripping wet clothes into the dryer.

### Maximum load size

Do not load more than maximum capacity.

These numbers refer to dry weight:

Natural fibres: 7kg max (15lb)

Synthetic fibres: 3kg max (6.6lb)

! DO NOT overload the dryer as this could result in reduced drying performance.

## Typical weights

**Note:** 1kg = 1000g (1lb = 16oz)





Clothes			
Blouse	Cotton	150g	(5oz)
	Other	100g	(3oz)
Dress	Cotton	500g	(1lb 2oz)
	Other	350g	(12oz)
Jeans		700g	(1lb 6oz)
10 nappies		1000g	(2lb 3oz)
Shirt	Cotton	300g	(10oz)
	Other	200g	(7oz)
T-Shirt		125g	(4oz)

Household Items			
Duvet cover (Double)	Cotton	1500g	(3lb 5oz)
	Other	1000g	(2lb 3oz)
Large Tablecloth		700g	(1lb 6oz)
Small Tablecloth		250g	(9oz)
Tea Towel		100g	(3oz)
Bath Towel		700g	(1lb 6oz)
Hand Towel		350g	(12oz)
Double Sheet		500g	(1lb 2oz)
Single Sheet		350g	(12oz)

At the end of a drying cycle, cottons could still be damp if you grouped cottons and synthetics together. If this happens simply give them an additional short period of drying.

## Wash Care Labels

Look at the labels on your garments, especially when tumble drying for the first time. The following symbols are the most common:

-  May be tumble dried
-  Do **not** tumble dry
-  Tumble dry at high heat setting
-  Tumble dry at low heat setting

## Items not suitable for tumble drying

- Articles that containing rubber or rubber-like materials or plastic film (pillows, cushions, or PVC rainwear), any other flammable articles or objects that contain flammable substances (towels soiled with hair spray).
- Glass fibres (certain types of draperies)
- Items which have been dry cleaned
- Items with the ITCL Code  (*see Special clothing items*). These can be cleaned with special at-home dry cleaning products. Follow instructions carefully.
- Large bulky items (quilts, sleeping bags, pillows, cushions, large bedspreads etc). These expand when drying and would prevent airflow through the dryer.

GB

Important Information

Installation

Description

The Display

Start and Programmes

Laundry

Warnings and Suggestions

Maintenance and Care

Troubleshooting

Service

# Laundry

GB

## Special clothing items

**Blankets and Bedspreads:** acrylic items (Acilan, Courtelle, Orion, Dralon) **must be dried** with special care on LOW heat setting. Avoid drying for a long period of time.

**Pleated or creased garments:** read the manufacturer's drying instructions on the garment.

**Starched articles:** do not dry these with non-starched items. Make sure that as much of the starch solution is removed from the load as possible before placing it in the dryer. Do not over-dry: the starch will become powdery and leave your clothing limp, which defeats the purpose of starch.

## Drying times

The table below presents APPROXIMATE drying times in minutes. Weights refer to dry garments:

Cottons						
Full Heat (use High Heat option for Timed Drying)						
Drying times 800-1000rpm in washing machine						
1kg	2kg	3kg	4kg	5kg	6kg	7kg
20-30	35-45	45-60	60-70	70-80	80-100	90-120
Synthetics						
Full Heat (use High Heat option for Timed Drying)						
Drying times on reduced spin in washing machine						
1kg	2kg		3kg			
20-40	30-50		40-70			
Delicates (e.g.Acrylics)						
Use Timed Drying with Low Heat option						
Drying times on reduced spin in washing machine						
1kg	2kg					
30	60					

Times are approximate and can vary depending upon:

- Amount of water retained in clothes after spin cycle: towels and delicates retain a lot of water.
- Fabrics: items that are the same type of fabric but different textures and thicknesses may not have the same drying time.
- Quantity of laundry: single items or small loads may take longer to dry.
- Dryness: If you are going to iron some of your clothes, they can be taken out while still a bit damp. Others can be left longer if you need them to be completely dry.
- Heat setting.
- Room temperature: if the room where the dryer is located is cold, it will take longer for the dryer to dry your clothes.
- Bulk: some bulky items can be tumble dried with care. We suggest that you remove these items several times, shake them out, and return them to the dryer until finished.

! Do not over-dry your clothes.  
All fabrics contain a little natural moisture, which keeps them soft and fluffy.

# Warnings and Suggestions

! The appliance has been designed and built according to international safety standards. These warnings are given for safety reasons and must be followed carefully.

## General safety

- This tumble dryer is not intended for use by persons (including children) with reduced physical, sensory or mental capabilities, or lack of experience and knowledge, unless they have been given supervision or instruction concerning use of the appliance by a person responsible for their safety.
- This tumble dryer has been designed for home, and not professional use.
- Do not touch the appliance while barefoot or with wet hands or feet.
- Unplug the machine by pulling on the plug, not the cord.
- Children must not be in proximity of the dryer when in use. After using the dryer, turn it off and unplug it. Keep the door closed to make sure that children do not use it as a toy.
- Children should be supervised to ensure that they do not play with the dryer.
- The appliance must be installed correctly and have proper ventilation. The air intake vents behind the machine, the outlet vents and the vent tube should never be obstructed (*see Installation*).
- Never direct the vent tube outlet towards the air intake at the back of the machine.
- Never allow the tumble dryer to recycle exhaust air.
- Never use the dryer on carpeting where the pile height would prevent air from entering the dryer from the base.
- Check to see if the dryer is empty before loading it.
-  The back of the dryer could become very hot. Never touch it while in use.
- Do not use the dryer unless the filter is securely in place (*see Maintenance*).
- Do not overload the dryer (*see Laundry*) for maximum loads.
- Do not load items that are dripping wet.
- Carefully check all instructions on clothing labels (*see Laundry*).
- Do not tumble dry large, very bulky items.
- Do not tumble dry acrylic fibres at high temperatures.
- Complete each programme with its Cool Tumble Phase.
- Do not turn off the dryer when there are still warm items inside.
- Clean the filter after each use (*see Maintenance*).
- Do not allow lint to collect around the dryer.
- Never climb on top of the dryer. It could result in damage.
- Always follow electrical standards and requirements (*see Installation*).
- Always buy original spare parts and accessories (*see Service*).

## To minimise the risk of fire in your tumble dryer, the following should be observed:

- Tumble dry items only if they have been washed with detergent and water, rinsed and been through the spin cycle. It is a fire hazard to dry items that HAVE NOT been washed with water.
- Do not dry garments that have been treated with chemical products.
- Do not tumble dry items that have been spotted or soaked with vegetable or cooking oils, this constitutes a fire hazard. Oil-affected items can ignite spontaneously, especially when exposed to heat sources such as a tumble dryer. The items become warm, causing an oxidation reaction with the oil, Oxidisation creates heat. If the heat cannot escape, items can become hot enough to catch fire. Piling, stacking or storing oil-affected items can prevent heat from escaping and so create a fire hazard. If it is unavoidable that fabrics containing vegetable or cooking oil or those that have been contaminated with hair care products be placed in a tumble dryer they should first be washed with extra detergent - this will reduce, but not eliminate the hazard. The cool tumble phase should be used to reduce the temperature of the items. They should not be removed from the dryer and piled or stacked while hot.
- Do not tumble dry items that have previously been cleaned in or washed in, soaked in or soiled with petrol/gasoline, dry cleaning solvents or other flammable or explosive substances. Highly flammable substances commonly used in domestic environments including cooking oil, acetone, denatured alcohol, kerosene, spot removers, turpentine, waxes and wax removers. Ensure these items have been washed in hot water with an extra amount of detergent before being dried in the tumble dryer.
- Do not tumble dry items containing foam rubber (also known as latex foam), or similarly textured rubber like materials. Foam rubber materials can, when heated, produce fire by spontaneous combustion.
- Fabric softener or similar products should not be used in a tumble dryer to eliminate the effects of static electricity unless the practice is specifically recommended by the manufacturer of the fabric softener product.
- Do not tumble dry undergarments that contain metal reinforcements eg. bras with metal reinforcing wires. Damage to the tumble dryer can result if the metal reinforcements come loose during drying.
- Do not tumble dry rubber, plastic articles such as shower caps or babies waterproof covers, polythene or paper.
- Do not tumble dry rubber backed articles, clothes fitted with foam rubber pads, pillows, galoshes and rubber coated tennis shoes.
- Remove all objects from pockets, especially lighters (risk of explosion).

! WARNING: Never stop the dryer before the end of the drying cycle unless all items are quickly removed and spread out so that the heat is dissipated.!

## Saving energy and respecting the environment

- Wring out items to eliminate excess water before tumble drying (if you use a washing machine first, select a high spin cycle). Doing this will save time and energy during drying.
- Always dry full loads - you save energy: single items or small loads take longer to dry.
- Clean the filter after each use to contain energy consumption costs (*see Maintenance*).

GB

Important Information

Installation

Description

The Display

Start and Programmes

Laundry

Warnings and Suggestions

Maintenance and Care

Troubleshooting

Service

# Maintenance and Care

GB

## Switching off the electricity

Unplug your dryer when not using it, when cleaning it and during all maintenance operations.

## Clean the filter after each cycle

The filter is an important part of your dryer: it accumulates lint and fluff that is formed while drying. Small items could also become trapped in the filter. When finished drying, therefore, clean the filter by rinsing it under running water or with your vacuum cleaner. Should the filter become clogged up, the airflow inside the dryer will be seriously compromised: drying times lengthen and you will consume more energy. It may also damage your dryer.

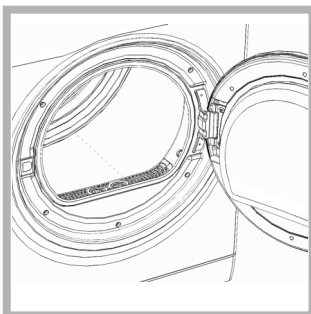

The filter is found in front of the dryer trim (*see diagram*).

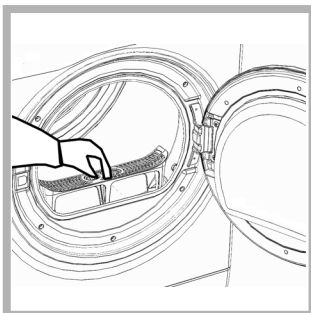

Removing the filter:  
1. Pull the plastic grip of the filter upwards (*see diagram*).

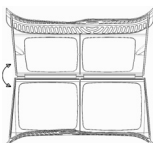

2. Open the filter and clean the lint from the inside.

3. Replace it correctly. Ensure the filter is fully located flush into the tumble dryer trim.

4. Remove any lint that has built up on the inside of the door and around the door seal.

! Do not use the dryer without replacing the filter.

## Check the drum after each cycle

Turn the drum manually in order to remove small items (handkerchiefs) that could have been left behind.

## Cleaning the drum

! Do not use abrasives, steel wool or stainless steel cleaning agents to clean the drum.

A coloured film may start to appear on the stainless steel drum, this may be caused by a combination of water and, or cleaning agents such as fabric conditioner from the wash. This coloured film will not affect the dryer performance.

## Cleaning

- External parts in metal or plastic and rubber parts can be cleaned with a damp cloth.
- Periodically check the vent tube and any permanent venting fixture to make sure that there has been no accumulation of fluff or lint, and remove it.
- Remove lint that collects around the filter and the outlet vents.

! Do not use solvents or abrasives.

! Your dryer uses special bearing components which do not need lubrication.

! Have your dryer checked regularly by authorised technicians to ensure electrical and mechanical safety (*see Service*).

One day your dryer seems not to be working. Before you call your Service Centre (*see Service*), go through the following troubleshooting suggestions:

**Problem:**

**Possible causes / Solution:**

**The tumble dryer won't start.**

- The plug is not plugged into the socket, or not making contact.
- There has been a power failure.
- The fuse has blown. Try to plug another appliance into the socket.
- You are using an extension cord? Try to plug the dryer's power cord directly into the socket.
- The door is not closed securely?
- The PROGRAMMES knob has not been set properly (*see Start and Programmes*).
- The START/PAUSE button has not been pressed (*see Start and Programmes*).

**Drying cycle will not begin.**

- You have set a delayed time (*see Start and Programmes*).

**Its taking a long time to dry.**

- The filter has not been cleaned (*see Maintenance*).
- The correct programme has not been selected for the type of fabric you are drying (*see Start and Programmes*).
- The flexible vent tube is obstructed (*see Installation*).
- The air intake vent is obstructed (*see Installation*).
- The permanent ventilation flap on the storm cover is obstructed (*see Installation*).
- The items were too wet (*see Laundry*).
- The dryer was overloaded (*see Laundry*).

**Programme finishes and clothes are damper than expected.**

! For safety the dryer has a maximum programme time of 3 hours. If an automatic programme has not sensed the required final moisture in this time the dryer will complete the programme and stop. Check the above points and run the programme again, if the results are still damp, contact the Service Centre (*see Service*).

**The START/PAUSE light flashes amber and all Option lights also flash to indicate a fault.**

- Try turning the dryer off and remove the plug. Then replace the plug and turn on, if a fault is still shown when you turn the dryer back on: note the lights that are on (not flashing) and contact the Service Centre (*see Service*).

GB

Important Information

Installation

Description

The Display

Start and Programmes

Laundry

Warnings and Suggestions

Maintenance and Care

Troubleshooting

Service

## Before calling the Service Centre:

- Use the troubleshooting guide to see if you can solve the problem yourself (*see Troubleshooting*).
- If not, turn off the dryer and call the Service Centre closest to you.

### What to tell the Service Centre:

- name, address and post code.
- telephone number.
- the type of problem.
- the date of purchase.
- the appliance model (Mod.).
- the serial number (S/N).

This information can be found on the data label inside the door of the machine.

## Spare Parts

This dryer is a complex machine. Repairing it yourself or having a non-authorized person try to repair it could cause harm to one or more persons, could damage the machine and could invalidate the spare parts warranty.

Call an authorised technician if you experience problems while using the machine.

---

# Recycling and Disposal Information



As part of our continued commitment to helping the environment, we reserve the right to use quality recycled components to keep down customer costs and minimise material wastage.

- Disposing of the packaging material: follow local regulations, so the packaging can be recycled.
- To minimise risk of injury to children, remove the door and plug - then cut off mains cable, flush with the appliance. Dispose of these parts separately to ensure that the appliance can no longer be plugged into a mains socket.

## Disposal of old electrical appliances

The European Directive 2002/96/EC on Waste Electrical and Electronic Equipment (WEEE), requires that old household electrical appliances must not be disposed of in the normal unsorted municipal waste stream. Old appliances must be collected separately in order to optimise the recovery and recycling of the materials they contain and reduce the impact on human health and the environment.



The crossed out "wheeled bin" symbol on the product reminds you of your obligation, that when you dispose of the appliance it must be separately collected.

Consumers should contact their local authority or retailer for information concerning the correct disposal of their old appliance.



This appliance conforms to the following EC Directives:  
- 2006/95/EC (Low Voltage Equipment)  
- 2004/108/EC (Electromagnetic Compatibility)



<b>5</b>	<b>Important Information</b>	<b>Installation</b>	<b>Description</b>	<b>The Display</b>	<b>Start and Programmes</b>	<b>Laundry</b>	<b>Warnings and Suggestions</b>	<b>Maintenance and Care</b>	<b>Troubleshooting</b>	<b>Service</b>
----------	------------------------------	---------------------	--------------------	--------------------	-----------------------------	----------------	---------------------------------	-----------------------------	------------------------	----------------





## Guarantee

### 12 months Parts and Labour Guarantee

Your appliance has the benefit of our manufacturers' guarantee, which covers the cost of breakdown repairs for twelve months from the date of purchase.

This gives you the reassurance that if, within that time, your appliance is proven to be defective because of either workmanship or materials, we will, at our discretion, either repair or replace the appliance at no cost to you.

#### The guarantee is subject to the following conditions:

- The appliance has been installed and operated correctly and in accordance with our operating and maintenance instructions.
- The appliance is only used on the electricity or gas supply printed on the rating plate.
- The appliance has been used for normal domestic purposes only.
- The appliance has not been altered, serviced, maintained, dismantled or otherwise interfered with by any person not authorised by us.
- Any repair work must be undertaken by us or our appointed agent.
- Any parts removed during repair work or any appliance that is replaced become our property.
- The appliance is used in the United Kingdom or Republic of Ireland.

#### The guarantee does not cover:

- Damage resulting from transportation, improper use, neglect or interference or as a result of improper installation.
- Replacement of any consumable item or accessory. These include but are not limited to: plugs, cables, batteries, light bulbs, fluorescent tubes and starters, covers and filters.
- Replacement of any removable parts made of glass or plastic.

THE GUARANTEE WILL NOT APPLY IF THE APPLIANCE HAS BEEN USED IN COMMERCIAL OR NON-DOMESTIC PREMISES.

#### Non-Domestic Usage Policy:

Indesit Company manufactures appliances for domestic use only. We understand that in some cases our appliances are used in commercial and/or non-domestic situations. We still provide a full 12 month manufacturers' guarantee, provided the appliance has not been:

**Accidentally damaged** - Damage that occurs suddenly as a result of an unexpected and non-deliberate external action.

**Maliciously damaged** - The deliberate and intentional damage to the product.

**Subjected to misuse** - Incorrect or careless or improper use.

**Subjected to overuse** - Excessive usage versus that expected of a domestically situated appliance.

### 5 Year Parts Guarantee

Hotpoint also offers you a FREE 5 year parts guarantee. This additional guarantee is conditional on you registering your appliance with us and the parts being fitted by one of our authorised engineers. There will be a charge for our engineer's time.

To activate the extra parts warranty on your appliance, simply call our **free phone** registration line on **0800 519 2102 (Republic of Ireland 1800 844 347)**



195100543.03 N

10/2012 - LION fpg - Four Ashes, Wolverhampton



### Extended Guarantees

We offer a selection of protection plans that enable you to fully cover yourself against the expense of repair bills for the life of your policy. To find the ideal plan for you please call our advice line on

**UK: 08448 226 226**

**Republic of Ireland: 01 230 0233**

### Free Helpdesk Service

We have a dedicated team who can provide free advice and assistance with your appliance if you experience any technical difficulties within the first 90 days of ownership. Simply call our Hotpoint Service Hotline on **08448 224 224 (Republic of Ireland 0818 313 413)** for telephone assistance, or, where necessary, to arrange for an engineer to call.

## After Sales Service

No one is better placed to care for your Hotpoint appliance during the course of its working life than us - the manufacturer.

## Essential Contact Information

### Hotpoint Service

We are the largest service team in the country offering you access to 400 skilled telephone advisors and 1100 fully qualified engineers on call to ensure you receive fast, reliable, local service.

**UK: 08448 224 224**

**Republic of Ireland: 0818 313 413**

**[www.hotpointservice.co.uk](http://www.hotpointservice.co.uk)**

**Please note: Our advisors will require the following information:**

Model number

Serial number

### Parts and Accessories

We supply a full range of genuine replacement parts as well as accessory products that protect and hygienically clean your appliance to keep it looking good and functioning efficiently throughout its life.

**UK: 08448 225 225**

**Republic of Ireland: 0818 313 413**

**[www.hotpointservice.co.uk](http://www.hotpointservice.co.uk)**

### Appliance Registration

We want to give you additional benefits of Hotpoint ownership. To activate your FREE 5 year parts guarantee you must register your appliance with us.

**Free phone UK: 0800 519 2102**

**Republic of Ireland: 1800 844 347**

**[www.hotpointservice.co.uk](http://www.hotpointservice.co.uk)**

## Free Manuals Download Website

<http://myh66.com>

<http://usermanuals.us>

<http://www.somanuals.com>

<http://www.4manuals.cc>

<http://www.manual-lib.com>

<http://www.404manual.com>

<http://www.luxmanual.com>

<http://aubethermostatmanual.com>

Golf course search by state

<http://golfingnear.com>

Email search by domain

<http://emailbydomain.com>

Auto manuals search

<http://auto.somanuals.com>

TV manuals search

<http://tv.somanuals.com>