

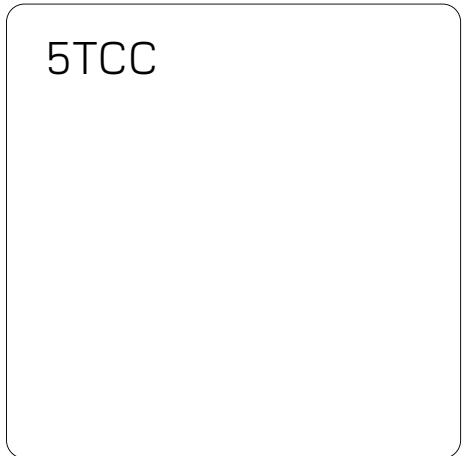

Designed for the real world

Instructions

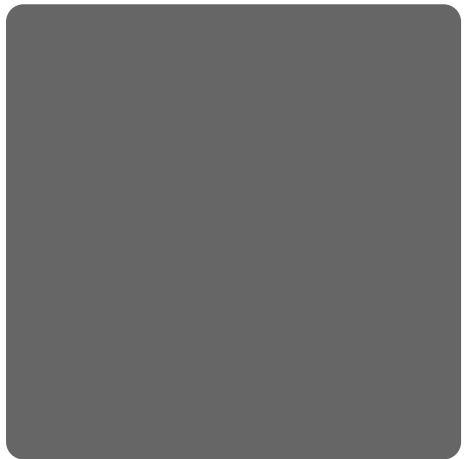

Contents

Introduction	4
Installation	5
For your Safety – Always	7
For your Safety – Never	8
Features	9
Control Panels	10
Ceramic Hob	11
Hotplates - General Notes	12
Choosing your Utensils	16
Temperature Conversion Chart	18
Grilling	19
Grill Chart	21
Oven Temperature Chart – Meat	22
Oven Temperature Chart – Baking	23
Main Oven Cookery Notes	24
Using the Main Oven for other Functions	26
Care and Cleaning	27
Cooking Results Not Satisfactory	30
Something Wrong with your Cooker	31
Key Contacts	Back Cover

You must read these instructions prior to using the appliance and retain them for future reference.

Introduction

Your new appliance is guaranteed* and will give lasting service. This guarantee is only applicable if the appliance has been installed in accordance with the installation instructions detailed in this booklet.

To help make best use of your cooking equipment, please read this booklet carefully.

The cooker is designed specifically for domestic use and responsibility will not be accepted for use in any other installation.

**When the cooker is first used an odour may be emitted,
this will cease after a period of use**

When first using the cooker ensure that the room is well ventilated (e.g. open a window or use an extractor fan) and that persons who may be sensitive to the odour avoid any fumes. It is suggested that any pets be removed from the room until the smell has ceased. This odour is due to temporary finish on oven liners and elements and also any moisture absorbed by the insulation.

*** The guarantee is subject to the provisions that the appliance:**

- (a) Has been used solely in accordance with the Users Instruction Book.**
- (b) Has been properly connected to a suitable supply voltage as stated on the rating plate attached to this equipment.**
- (c) Has not been subjected to misuse or accident or been modified or repaired by any person other than the authorised employee or agent.**
- (d) Has been correctly installed.**

Disposal of your product

To minimise the risk of injury to children please dispose of your product carefully and safely. Remove all doors and lids. Remove the mains cable (where fitted) by cutting off flush with the appliance and always ensure that no plug is left in a condition where it could be connected to the electricity supply.

To help the environment, Local Authority instructions should be followed for the disposal of your product.

This appliance conforms to the following EEC Directives:

Electromagnetic Compatibility
89/336/EEC
92/31/EEC
93/68/EEC

Low Voltage Equipment
73/23/EEC
93/68/EEC



Installation

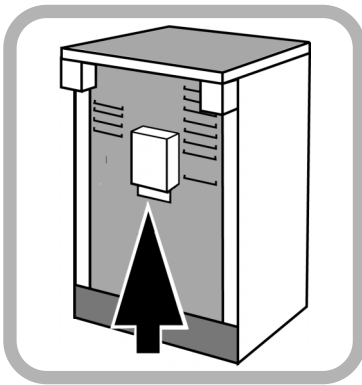

WARNING – THIS APPLIANCE MUST BE EARTHED.

Your cooker should have been checked to ensure that the voltage corresponds with your supply voltage, this is stated on the **rating plate**, which is situated on the rear panel. The cooker must be connected by a competent person, such as one who is a NICEIC registered contractor, to a suitable double-pole control unit with a minimum rating of 32A and a minimum contact clearance of 3mm (applicable to newer properties, older properties where a 30A double pole control unit and a minimum contact clearance of 3mm is acceptable).

The double pole control unit should be fitted adjacent to the cooker, in accordance with IEE regulations. The control unit must be within 2 metres of, but not directly above the appliance and should be easily accessible in the event of an emergency.

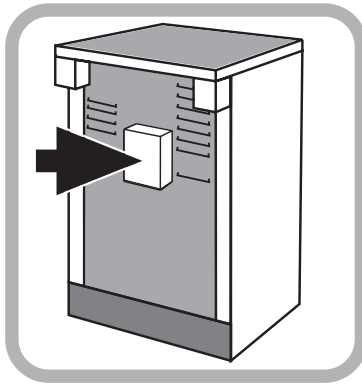

The power supply cable should conform to B.S.6004 with a conductor size of 6mm² minimum.

This appliance conforms to EN 55014 regarding suppression of radio and television interference.

Access to the **mains terminals** is gained by removing the **rear access cover**.

The mains cable must pass through the cable clamp adjacent to the terminal block. Sufficient cable should be used to allow the cooker to be pulled out for servicing.

Ensure that the mains cable is routed away from any brackets affixed to the rear panel and is not trapped to the rear wall when pushing the cooker into position between cabinets.

Siting the Cooker

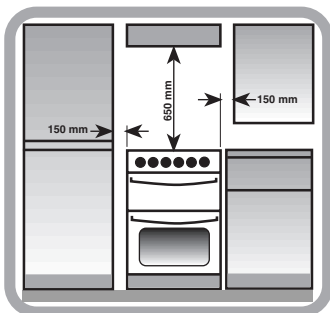

The height of the cooker can be adjusted by means of adjustable feet in the plinth (900mm - 915mm). Adjust the feet by tilting the cooker from the side. Then install the product into position.

NOTE: This appliance must not be fitted on a platform.

The cooker is designed to fit between kitchen cabinets spaced 500mm apart. The space either side need only be sufficient to allow withdrawal of the cooker for servicing. It can be used with cabinets one side or both as well as in a corner setting. It can also be used free-standing.

Adjacent side walls which project above hob level, must not be nearer to the cooker than 150mm and should be protected by heat resistant material. Any overhanging surface or cooker hood should not be nearer 650mm.

Installation

Moving the Cooker

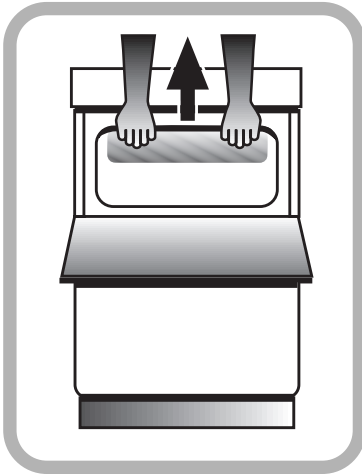

Before moving your cooker check that it is cool, and switch off at the cooker control unit.

Movement of your cooker is most easily achieved by lifting the front as follows:
Open the grill door sufficiently to allow a comfortable grip on the underside front edge of the oven roof, avoiding any grill elements.

Note: Take care in moving the cooker as it is heavy. Take care to ensure that any floor covering is not damaged.

Splash Panel Kit (Wall Mounted)

Splashplate optional, apply to Parts Department (see Back Cover for contact number.)

For Your Safety



When used properly your appliance is completely safe but as with any electrical product there are certain precautions that must be observed.

PLEASE READ THE PRECAUTIONS BELOW BEFORE USING YOUR APPLIANCE.

Always

- Always make sure you remove all packing from inside the oven and grill compartments before switching on for the first time.
- Always make sure you understand the controls prior to using the appliance.
- Always keep children away from the appliance when grilling as the surfaces will get extremely hot during and after use.
- Always make sure all controls are turned off when you have finished cooking and when not in use.
- Always stand back when opening an oven door to allow any build up of steam or heat to disperse.
- Always use dry good quality oven gloves when removing items from the oven/grill.
- Always place pans centrally over the hotplate making sure handles are kept away from the edge of the hob and cannot become heated by other hotplate/pans.
- Always take care to avoid heat/steam burns when operating the controls.
- Always turn off the electricity supply at the wall switch before cleaning and allow the appliance to cool.
- Always make sure the shelves are in the correct position before switching on the oven.
- Always keep the oven and grill doors closed when the appliance is not in use.
- Always take care when removing items from the grill when the lower oven is on as the contents will be hot.
- Always keep the appliance clean, as a build up of grease or fat from cooking can cause a fire.
- Always follow the basic principles of food handling and hygiene to prevent the possibility of bacterial growth.
- Always keep ventilation slots clear of obstructions.
- Always refer servicing to a qualified appliance service engineer.
- Always take care to avoid touching heating elements inside the oven, as during use the oven becomes hot.

Safety Advice

IN THE EVENT OF A CHIP PAN FIRE OR ANY OTHER PAN FIRE.

1. TURN OFF THE COOKER APPLIANCE AT THE WALL SWITCH.
2. COVER THE PAN WITH A FIRE BLANKET OR DAMP CLOTH, this will smother the flames and extinguish the fire.
3. LEAVE THE PAN TO COOL FOR AT LEAST 60 MINUTES BEFORE MOVING IT. Injuries are often caused by picking up a hot pan and rushing outside with it.

NEVER USE A FIRE EXTINGUISHER TO PUT OUT A PAN FIRE as the force of the extinguisher is likely to tip the pan over.

Never use water to extinguish oil or fat fires.

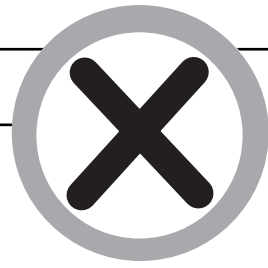

Never

- Never leave children unsupervised where a cooking appliance is installed as all surfaces will be hot during and after its use.
- Never allow anyone to sit or stand on any part of the appliance.
- Never store items above the appliance that children may attempt to reach.
- Never leave anything on the hob surface when unattended and not in use.
- Never remove the oven shelves whilst the oven is hot.
- Never heat up unopened food containers as pressure can build up causing the container to burst.
- Never store chemicals/food stuffs, pressurised container in or on the appliance, or in cabinets immediately above or next to the appliance.
- Never place flammable or plastic items on or near the hob.
- Never fill a deep fat frying pan more than 1/3 full of oil, or use a lid. **DO NOT LEAVE UNATTENDED WHILE COOKING.**
- Never operate the grill with the grill door closed as this will cause the appliance to overheat.
- Never use the appliance as a room heater.
- Never use the grill to warm plates.
- Never dry any items on either the hob or oven doors.
- Never install the appliance next to curtains or other soft furnishings.
- Never use steam cleaners.

Features

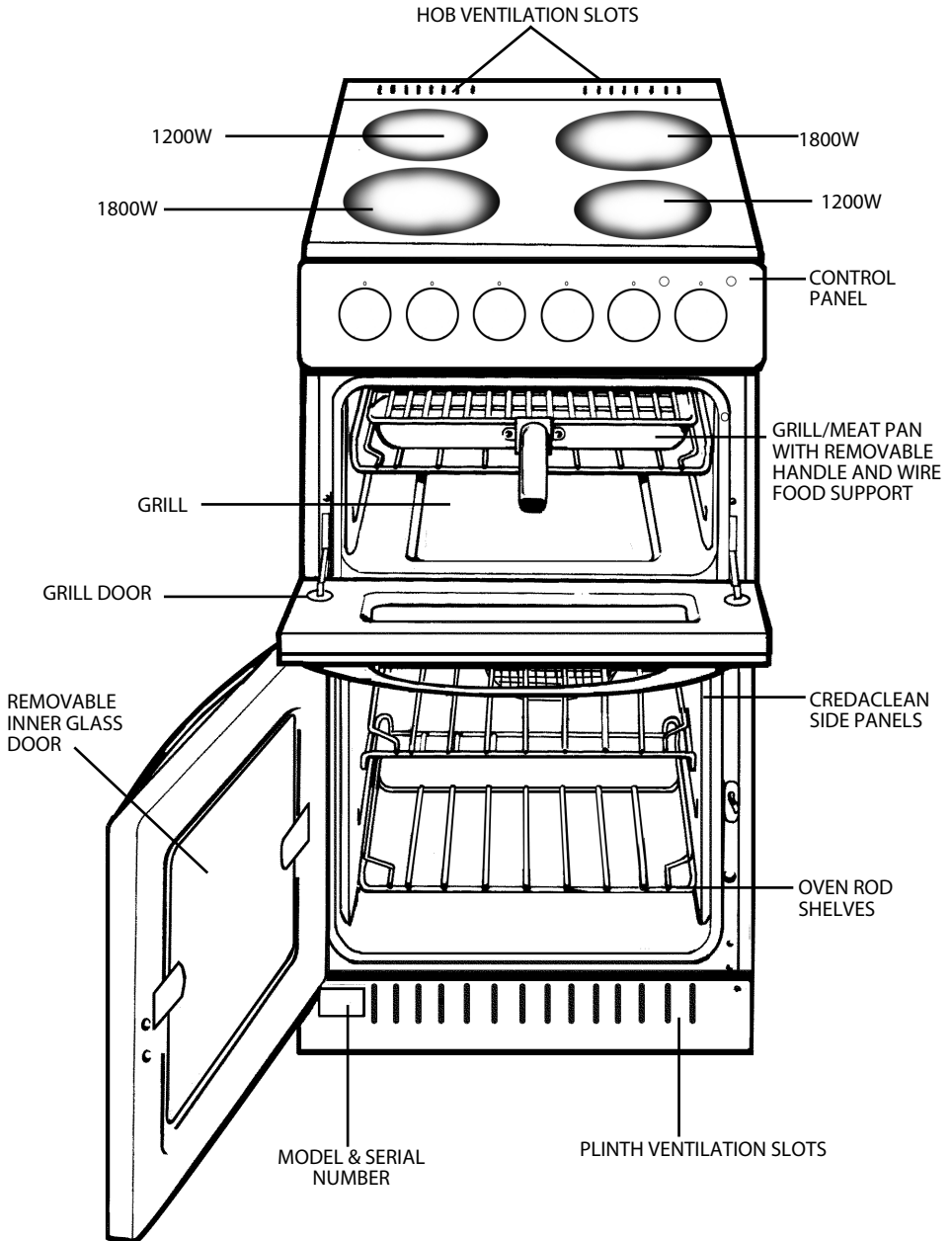

Control Panels

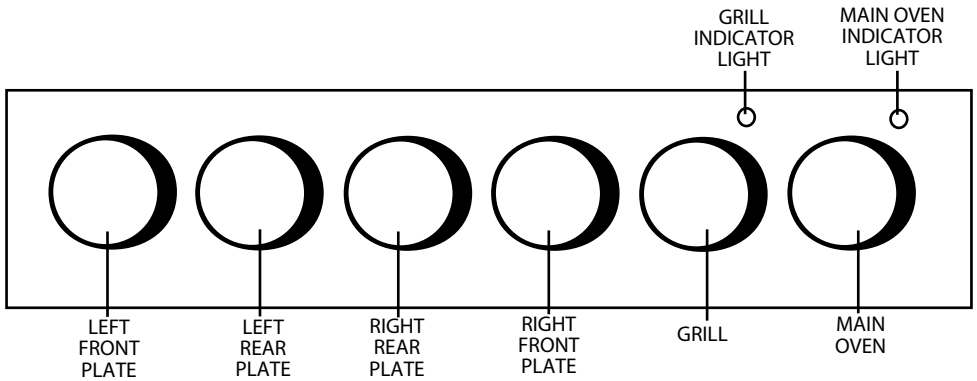

Control Knobs

The knobs for the hotplates can be rotated in either direction to provide variable heat control, the Main Oven knob can only be rotated clockwise from the **Off** position.

Note: Always ensure that all controls are in the OFF position, when the appliance is not in use.

Operating the control when the grill is in use

In common with all cookers having controls sited above the grill compartment, care must be taken when setting the controls, due to hot air being emitted from the grill compartment.

Ceramic Hob

CAUTION: IF AT ANY TIME A CRACK IN THE SURFACE BECOMES VISIBLE, DISCONNECT THE APPLIANCE IMMEDIATELY FROM THE SUPPLY.

Under no circumstances should the hob be used with aluminium foil in contact with the hob surface as damage can occur.

The following boiling plates are located beneath the decorative circular patterned cooking areas:-

Front left	6 heat	1800W
Rear left	6 heat	1200W
Rear right	6 heat	1800W
Front right	6 heat	1200W

The cooking areas change colour when heated (become red) indicating which heating element is switched on. The cooking area returns to its original colour when the heating element is switched **Off**.

Warning: Even though the cooking area has returned to its original colour it may still be hot. The controls for the hotplates can be turned in either direction. Turn the control to 6 for fast cooking. To reduce the heat to cook more slowly or simmer, turn the control to a lower setting according to the size of the saucepan and the amount of liquid. Pans can be placed on the unheated areas of the panel when cooking is finished and before serving food. It is inadvisable at any time to leave a heating element switched on without a pan in position as this wastes energy, and could make soil or rub-off from aluminium pans more difficult to remove. To protect elements against over-heating, safety cut-outs have been incorporated with each element. After several minutes with the control at setting 6 the safety cut-out switches the element **Off** and **On** continuously, thus preventing any adverse effects that may be caused by an excessive build-up of heat in the cooking area.

Hotplates General Information Notes

USE OF HOTPLATES

Under no circumstances should the hob be used with aluminium foil in contact with the hob surface.

Turn the control to 6 for fast cooking. To cook more slowly or simmer, turn the control to a lower setting according to the size of the saucepan and the amount of liquid. The two small Hotplates are specially for smaller pans, low temperature cooking and simmering.

Do Not leave a hotplate switched on without a pan as this wastes energy and may shorten the life of the hotplate.

CONTROL SETTINGS GUIDE

This is provided only as a guide – settings also depend on the type of pan used and the quality of food.

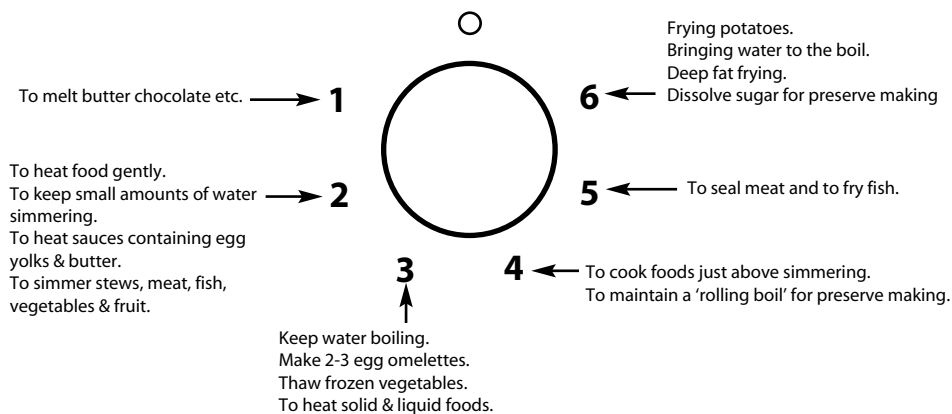

General Information Notes - Ceramic Hobs

PANS SHOULD



Not be concave (bowed in)



Not be convex (bowed out)



Not be rimmed



Not be deeply ridged



But essentially Flat

Always ✓	Never X
<ul style="list-style-type: none"> ● Use good quality flat-based cookware on all electric heat sources. ● Always ensure pans have clean, dry bases before use. ● Ensure pans match size of heating area. ● Remember good quality pans retain heat well, so generally only a low or medium heat is necessary. ● Ensure pan handles are positioned safely and away from heat sources. ● Always lift pans, do not drag. ● Always use pan lids except when frying. ● Deal with spillages immediately but with care. 	<ul style="list-style-type: none"> ● Use gauze, metal pan diffusers, asbestos mats and stands e.g. Wok stands – they can cause overheating. ● Use utensils with skirts or rims e.g. buckets and some kettles. ● Use badly dented or distorted pans. ● Leave an element switched on when not cooking. ● Cook food directly on the ceramic glass. ● Drag or slide utensils, along the hob surface.

THE BEST COMBINATIONS

This table is a general guide to the types of pan suitable for different types of hobs and cookers. Remember pans should be good quality, with smooth, flat bases. For any further information refer to manufacturers' instructions.

	Ceramic*	Halogen*
Aluminium	✓	✓
Stainless steel with single layer copper base	X	X
Stainless steel with sandwich bases of aluminium and stainless or aluminium and copper.	✓	✓
Enamelled steel	✓	✓
Enamelled aluminium	✓	✓
Enamelled based cast iron	✓ With Extra Care	
Copper	X	X
Toughened glass or ceramic/glass/pottery	Not Recommended	
Mild steel, Ferro-magnetic or stainless with a magnetic sandwich base	✓	✓

✓ suitable X unsuitable
 *care should be taken when using any pans on these surfaces not to drag and cause scratching.

General Information Notes (Ceramic Hobs)

Do Not

- Do not** cook directly on the hob surface without a cooking utensil, as this will result in damage to the surface of the hob.
- Do not** use the hob as a worktop surface as damage may occur to the smooth surface of the hob.
- Do not** drag or slide utensils on the hob surface, as this will cause scratches in the surface of the hob.
- Do not** allow a cooking utensil to come into contact with the hob surround.
- Do not** place anything between the base of the utensil and the ceramic hob, e.g. do not use asbestos mats, aluminium or wok stand.

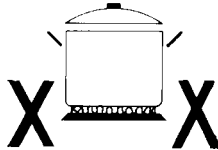

- Do not** leave any utensils, food or combustible items on the hob when it is not in use.
- Do not** place aluminium or plastic foil, or plastic containers on the hob.
- Do not** leave the hotplates or cooking areas switched **On** unless they are being used.

We recommend not to place large preserving pans or fish kettles across two heating areas.

- Do not** leave utensils partly covering the heated areas. Always ensure that they are placed centrally over the heated areas and have the same diameter as the heating area used.

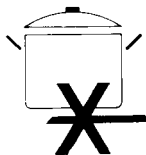

We recommend not to use a utensil with a base diameter greater than 25cm (10ins).

Pressure cookers or other large pans should be used on the front cooking areas.

Always ensure that saucepan handles are positioned safely.

General Information Notes (Ceramic Hobs)

Safety requirements for deep fat frying

IMPORTANT – As with any cooking appliance there could be some fire risk attached to the heating of oil, particularly for deep fat frying, cooking utensils containing oil **must not be left unattended** (e.g. to answer the telephone) on or in close proximity to the patterned cooking areas.

1. Use a deep pan, large enough to completely cover the appropriate heating area.
2. Never fill the pan more than one-third full of fat or oil.
3. Never leave oil or fat unattended during the heating or cooking period.
4. Do not try to fry too much food at a time, especially frozen food. This only lowers the temperature of the oil or fat too much, resulting in greasy food.
5. Always dry food thoroughly before frying, and lower it slowly into the hot oil or fat. Frozen foods, in particular, will cause frothing and spitting, if added too quickly.
6. Never heat fat, or fry, with a lid on the pan.
7. Keep the outside of the pan clean and free from streaks of oil or fat.

SAFETY ADVICE IN CASE OF A CHIP-PAN FIRE

In the event of a chip pan fire or any other pan fire.

1. TURN OFF THE COOKER APPLIANCE AT THE WALL SWITCH.
2. COVER THE PAN WITH A FIRE BLANKET OR DAMP CLOTH, this will smother the flames and extinguish the fire.
3. LEAVE THE PAN TO COOL FOR AT LEAST 60 MINUTES BEFORE MOVING IT. Injuries are often caused by picking up a hot pan and rushing outside with it.

**NEVER USE A FIRE EXTINGUISHER TO PUT OUT A PAN FIRE as the force of the extinguisher is likely to tip the pan over.
Never use water to extinguish oil or fat fires.**

Choosing Your Utensils

Choosing your utensils

Below are some guidelines to help you make the right choice of utensils.

To obtain a satisfactory performance from a ceramic hob and to avoid unnecessary damage, we recommend the use of good quality utensils with smooth flat bases.

Remember

1. Purchasing a new pan will not necessarily mean it will have a flat base, always check before buying. See diagram below.
2. Using the correct pans and utensils will result in maximum contact with the hob and maximum efficiency as with any type of electric hob.

Do use good quality smooth flat based utensils.

Do use a utensil which has approximately the same base area as the heating area zone being used.

Do use utensils which have more than sufficient capacity for the amount of food being cooked to prevent boil over or spillage.

Do use utensils with good fitting lids.

Do use a low dome pressure cooker for best results.

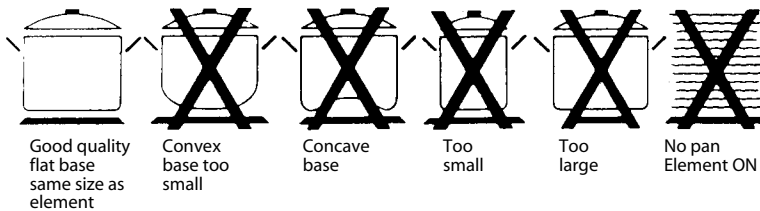

WARNING: Extreme caution should be used when cleaning the hot hob.

Important

1. Always clean up any spillage immediately with a clean cloth or a paper towel to avoid unnecessary damage to the hob.
Extreme care should be taken to avoid steam burns and hot surfaces when cleaning spillage from the hob.
2. When cooking food which contains sugar (most food) or syrup, use a utensil which is large enough to prevent boil over or spillage. **Sugar spillage will permanently damage the hob and therefore should be cleaned off with care immediately.** If sugar spillage has occurred, remove it as long as it is still hot with a metal safety razor scraper provided. This will avoid any damage. **NEVER LET IT COOL BEFORE REMOVING.**
3. Always ensure that the base of the utensil is dry before placing on the ceramic hob.

Choosing Your Utensils

Do not use utensils with rough bases.

Do not use lightweight utensils with thin, distorted or uneven bases.

Do not use lightweight enamelled steel utensils.

Do not use cast iron utensils.

Do not use utensils with recessed, scrolled or ridged bases.

Do not use a utensil which has a base concavity greater than 1 mm as this will reduce the performance of the hob.

Do not use a utensil with a convex base.

Do not use glass ceramic utensils.

Do not use use lightweight saucepans with plain thin copper bases on ceramic or halogen hot plates.

Note: All copper pans are excellent conductors of heat, and are hard wearing and strong, but need quite a lot of care. They can be very heavy and do not usually have completely flat bases. The interiors are usually lined with a different material such as tin.

A stainless steel pan with a sandwich base of aluminium and stainless steel is an excellent conductor of heat and is suitable for use on ceramic and halogen hobs, providing they are used in accordance with the saucepans manufacturers' recommendations.

Stainless steel pans with a sandwich base of aluminium and copper are excellent conductors of heat. If using stainless steel saucepans with aluminium and copper sandwich bases on ceramic and halogen hobs, the use of these pans must be in accordance with the saucepan manufacturers' recommendations. Extra care should be taken to ensure the base of the pan and the hob is cleaned, and the hob conditioned, after each and every use, when using this type of saucepan.

If these recommendations are not followed, the result will be a build up of small copper deposits on the surface of your hob which, if not cleaned after each use, will result in permanent marking of your hob.

Always lift the pan from the hob, **do not** drag or slide across the hob surface as damage may occur.

Temperature Conversion Chart

Gas Mark	°F	Main Convection Oven	Top Convection Oven	Main Fan Oven
1/2	250	120	110	100
1	275	140	130	120
2	300	150	140	130
3	325	160	150	140
4	350	180	170	160
5	375	190	180	170
6	400	200	190	180
7	425	220	210	200
8	450	–	220	210
9	475	–	–	220

Grilling

GRILLING MUST BE DONE WITH THE GRILL DOOR OPEN. CONTROL KNOBS MAY BECOME HOT DURING GRILLING. CAUTION: ACCESSIBLE PARTS WILL BECOME HOT WHEN THE GRILL IS USED – CHILDREN SHOULD BE KEPT AWAY.

To operate the grill proceed as follows:

Grill Pan Handle

- Open the grill door.
- Pre-heat the grill on setting 6 for approximately 5 minutes. (see chart on guide to grilling).
- Fix the grill pan handle securely in position. See below.
- Food which only requires browning should be placed directly on/in the grill pan in the grill pan runner, or on the floor of the grill compartment. (the grill pan grid may be removed.)
- Leave the control on setting 6 for toast, sealing and fast cooking of foods. For thicker foods requiring longer cooking turn the control to a lower setting after the initial sealing, on both sides, on setting 6. The thicker the food the lower the control should be set.

Warning: Take care as the grill will be hot – always wear oven gloves. Always ensure that the grill pan is clean BEFORE use. Excess fat build up in the bottom of the pan could cause a fire hazard. Never line grill pan with foil.

Fixing the Grill Pan Handle

The grill pan handle is detachable from the pan, to facilitate cleaning and storage. Fix the grill pan handle securely in position before use. The handle fits onto the grill pan edge with the small recess, Fig.1. Tilt the handle over the recess and slide it towards the centre, Fig.2. Ensure the handle is fully located. Insert the washer and fixing screw and tighten fully to ensure handle is secured, Fig.3.

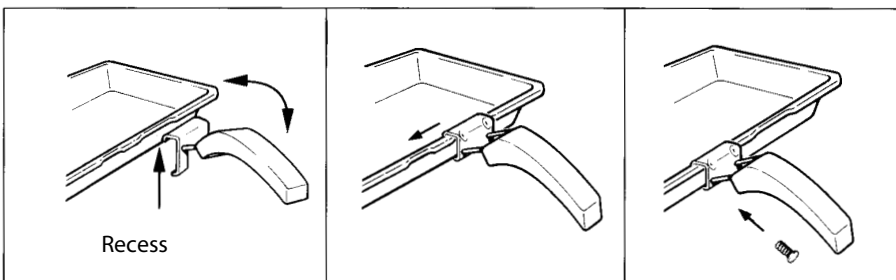

Fig. 1

Fig. 2

Fig. 3

Always fit the screw prior to use.

Grilling (continued)

The food to be cooked should be placed on the grill pan/grill pan food support.

Place the grill pan on the runners and push back to the stop position when the grill pan is correctly positioned beneath the grill element.

Plates and dishes placed on the floor of the grill compartment will be heated when the oven is in use.

Grill Compartment as a 'Hotcupboard' **Do not** operate the grill control when using the compartment as a hotcupboard.

Do take care when removing plates, dishes and utensils from the grill compartment when the oven is in use as they may become quite hot.

You may need to use oven gloves when removing warmed items.

Grill Chart

Pre - heat the grill for 5 minutes on maximum control setting before grilling

GRILL CHART

Food	Grill Setting	Approximate Cooking time
Toasting of Bread products	6	3 - 10 mins.
Small cuts of meat, sausages, bacon, etc.	5-6	15 - 20 mins.
Chops etc. Gammon steaks Chicken pieces	5	20 - 25 mins. Wire food support used in upturned position for chicken.
Fish: fingers Whole Filletts	5	10 - 20 mins. Whole fish and fillets placed in the base of the grill pan.
Fish in breadcrumbs	5	15 - 20 mins.
Pre - Cooked potato products	5	15 - 20 mins.
Pizzas	5	12 - 15 mins. in the base of the grill pan.
Browning of food	6	8 - 10 mins. Dish placed directly on base of the grill pan and pan placed on the base of the grill compartment.

The settings in the above guide have been developed to cook food successfully without excessive fat spitting and splashing.

Oven Temperature Charts – Meat

Top Oven Cooking				Fan Oven Cooking				
Meat	Pre-heat	Temperature °C	Time (approx.)	Position in Oven	Meat	Pre-heat	Temperature °C	Time (approx.)
Beef/Lamb (slow roasting)	Yes	170/180	35 mins per 450g (1lb) + 35 mins over.	Shelf placed directly on floor of oven.	Beef	No	160/180	20-25 mins per 450g (1lb) + 20 mins extra
Beef/Lamb (foil covered)	Yes	190/200	35-40 mins per 450g (1lb)		Lamb	No	160/180	25 mins per 450g (1lb) + 25 mins extra
Pork (slow roasting)	Yes	170/180	40 mins per 450g (1lb) + 40 mins over		Pork	No	160/180	25 mins per 450g (1lb) + 25 mins extra
Pork (foil covered)	Yes	190/200	40 mins per 450g (1lb)		Veal	No	160/170	25-30 mins per 450g (1lb) + 25 mins extra
Veal (slow roasting)	Yes	170/180	40-45 mins per 450g (1lb) + 40 mins over		Chicken/Turkey up to 4kg (8lb)	No	160/180	18-20 mins per 450g (1lb) + 20 mins extra
Veal (foil covered)	Yes	190/200	40-45 mins per 450g (1lb)		Turkey up to 5.5kg (12lb) over 5.5kg (12lb)	No	150/160	13-15 mins per 450g (1lb) e.g. 5kg (11lb) = 143-165 mins 12 mins per 450g (1lb) e.g. 10kg (22lb) = 264 mins
Poultry/Game (slow roasting)	Yes	170/180	25-30 mins per 450g (1lb) + 25 mins over		Casserole Stews	No	140-150	1 1/2 - 2 hrs
Poultry/Game (foil covered)	Yes	190/200	25-30 mins per 450g (1lb)					
Casserole Cooking	Yes	150	2-2 1/2 hrs					

if using aluminium foil, never: 1. Allow foil to touch sides of oven. 2. Cover oven interior with foil. 3. Cover shelves with foil.

The most accurate method of testing the readiness of joints of meat or whole poultry is to insert a meat thermometer into the thickest part of a joint, or the thickest part of poultry thighs, during the cooking period. The meat thermometer will indicate when the required internal temp has been reached.

Beef - Rare: 60°C **Lamb:** 80°C **Poultry:** 90°C
 Medium: 70°C **Pork:** 90°C
 Well Done: 75°C **Veal:** 75°C

Oven Temperature Charts – Baking

Baking	Fan Oven Cooking		
	Pre-heat	Temperature °C	Time in mins.
Scones	Yes	210/220	8-10
Small Cakes		170/180	15-20
Victoria Sandwich		160/170	20-25
Sponge Sandwich	Yes	170/190	15-20
Swiss Roll	Yes	180/200	12-15
Semi-rich Fruit Cake		140/150	75-90
Rich Fruit Cakes		130/140	Depending on size.
Shortcrust Pastry		190/200	45-50
Puff Pastry		190/200	Depending on use.
Yorkshire Pudding	Yes	180/190	40-45
Individual Yorkshire Puddings	Yes	190/200	20-25
Milk Pudding		130/140	105-135
Baked Custard		140/150	40-50
Bread	Yes	200/210	45-50
Meringues		80-90	180-240

Note: If soft margarine is used for cake making, temperatures recommended by the manufacturers should be followed. Temperatures recommended in this chart refer to cakes made with block margarines or butter only.

Main Oven Cookery Notes

The oven is fitted with 'Creda clean' liners and two rod shelves.

To heat the oven, turn the control knob clockwise, selecting the required temperature 80°C (175°F) and 230°C (450°F) as recommended in the temperature chart. The indicator light will immediately come on and remain on until the oven reaches the required temperature. This light will then automatically go off and on during cooking as the oven thermostat maintains the correct temperature.

It should be noted that at the end of a cooking period there may be a momentary puff of steam when the oven door is opened. This will disperse in a few seconds and is a perfectly normal characteristic of an oven with a good door seal.

Since a fan oven heats up more quickly, and generally cooks food at a lower temperature than a conventional oven, preheating the oven is often unnecessary. However food such as bread, scones, Yorkshire pudding, do benefit from being placed in a pre-heated oven.

The charts are a guide only, giving approximate cooking temperatures and times. To suit personal taste and requirements, it may be necessary to increase or decrease temperatures by 10°C

Unless otherwise indicated in the charts, food is placed in a cold oven, i.e. without pre-heating. If food is placed in an already hot oven, the suggested cooking time should be reduced, depending on the type and quantity of food being cooked.

Oven Positions

Since the distribution of heat in the circulaire ovens is very even, most foods will cook satisfactorily on any shelf position, but the shelves should be evenly spaced. Do not fit shelves upside down. The Top Oven rod shelf can be used in the Main Oven when cooking large quantities of food. Additional shelves can be purchased through your oven supplier or Spares Centre. Never use more than 3 shelves in the oven as air circulation will be seriously restricted. To ensure even circulation do not use meat pans larger than 390 x 300mm (15" x 12") and baking trays no larger than 330 x 255mm (13" x 10"), these should be positioned centrally on the oven shelf. Food should not be placed directly on the floor of the oven. To avoid unnecessary cleaning, rod shelves which are not in use should be removed from the oven.

Temperature and Time

When **three** shelves are used to cook large quantities of food for home freezing or parties, it may be necessary to increase the cooking times given in the charts by a few minutes, to allow for the loss of heat due to the extra time taken to load the oven, and the large mass of food. Baking trays should allow an equal gap at either side of the oven.

N.B. Recipes in cookery books give times and temperatures for cooking in ordinary ovens. The introduction of improved thermal insulation on fan ovens makes it possible, in most cases, to reduce (a) the recommended temperature by 25°C (45°F) and (b) the recommended time by approximately 10 minutes per hour.

Main Oven Cookery Notes

To prepare meat and poultry for roasting in your fan oven.

- (a) Wipe the meat or poultry, dry well and weigh it. Meat which has been stored in a refrigerator should be allowed to come to room temperature before cooking, and frozen meat or poultry must be completely defrosted before placing in the oven.
- (b) The weight of any stuffing used should be added before calculating the cooking time.
- (c) Place meat/poultry in the meat pan supplied with your cooker. Small joints weighing less than 1.75kg (3½ lbs) should be roasted in a smaller meat pan/tin - or they may be 'pot roasted' - a small joint in a large meat pan causes unnecessary oven splashing and evaporation of meat juices.
- (d) Additional fat should not be added, except for veal, very lean meat or poultry which can either be 'larded' with fat bacon or brushed **very sparingly** with cooking oil or melted fat.
- (e) Beef, lamb, mutton and poultry may be dusted lightly with seasoned flour to give a crisp outer surface. The skin of duck and goose should be pricked to release excess fat during cooking, and the rind of pork should be scored, brushed lightly with oil, and rubbed with salt, to give crisp crackling.
- (f) Meat and poultry wrapped in, or covered with a tent of aluminium foil will be juicy and tender. Roasting bags offer the same advantages. Always follow the manufacturers pack instructions, and remember to reduce the temperatures given for conventional ovens by approximately 25°C and the time by approximately 10 minutes per hour.
- (g) Potatoes for roasting only require to be brushed with cooking oil or melted fat.
- (h) It is not necessary to baste when roasting in an electric oven and stock or liquid should not be added to the meat pan since this only causes unnecessary soiling, steam and condensation.

Frozen Meat and Poultry

Joints of meat and whole birds should be defrosted slowly, preferably in a domestic refrigerator (allowing 5 - 6 hours per 450g, 1lb), or at room temperature (allowing 2-3 hours per 450g, 1lb).

The breast should be covered with foil, held in position by skewers or string, and the giblets removed after defrosting but before cooking.

THIS METHOD OF DEFROSTING IS ONLY RECOMMENDED FOR MEAT/POULTRY UP TO 2kg (4lb) IN WEIGHT, AND IT IS ESSENTIAL TO COOK IT THOROUGHLY, IMMEDIATELY AFTERWARDS.

Using the Main Oven for Other Functions

90° SLOW Setting

This is used for slow cooking, keeping food warm and warming plates for short periods. Extra care should be taken when warming bone china, as it may be damaged in a hot oven.

DO NOT place food or plates directly on the oven floor as this could damage both the oven lining and the plates which are being warmed.

Advantages of "SLOW" cooking are:

The oven stays cleaner because there is less splashing.
Timing of food is not as critical, so there is less fear of overcooking.
Inexpensive joints of meat are tenderised.
Fully loading the oven can be economical.
Cooking times can be extended in some cases by up to 2 hours.

Operation:

1. Place the prepared food in the main oven and ensure the door is fully closed.
2. Select 'S' (Slow Cooking Temperature) by turning the Main Oven Control clockwise ensuring the oven door is fully closed.

Storage and re-heating of food:

1. If food is to be frozen or not used immediately, place it in a clean container and cool as soon as possible.
2. Always thaw frozen food completely in the refrigerator before re-heating.
3. Always reheat food thoroughly and ensure it is piping hot before serving.
4. Only re-heat food **once**.

Points to consider when preparing food for "SLOW" cooking:

1. Make sure that the dishes to be used will fit into the oven ensuring enough room for air to circulate.
2. All dishes cooked on the slow setting will require a minimum of 6 hours, however, if they are cooked for 1-2 hours longer then deterioration in their appearance may be noticed.
3. Never cook joints of meat over 2.7kg (6 lb) or poultry over 2.0kg (4lb 8oz). We do not recommend that joints of meat or poultry are stuffed before cooking on the slow setting.
4. To seal in the meat juices, always cook meat or poultry at 170°C for 30 minutes before wrapping in foil and placing on a rack over a tin (to allow good air circulation) before turning the control to the slow setting and cooking immediately.
5. Always ensure that joints of pork and poultry are thoroughly cooked by checking with a meat thermometer before serving.
6. Always thaw frozen foods completely before cooking. We do not recommend placing frozen food in the oven to cook.
7. Always bring soups, liquids and casseroles to the boil before placing in the oven.
8. Ensure that casserole dishes have a good seal (not airtight) and cover to the top with foil to prevent loss of moisture.
9. Ensure that fruit and vegetables are cut into even sized small pieces to cook properly.
10. Always adjust seasoning before serving.
11. If using dried red kidney beans it is important that the beans are soaked and then boiled for a minimum of 10 minutes before using in any dish to destroy any toxins.
12. When cooking fish or egg dishes it may be necessary to check during cooking to avoid overcooking.

Care and Cleaning



Cleaning materials to avoid

TURN OFF THE MAIN COOKER WALL SWITCH BEFORE CLEANING. BEFORE SWITCHING ON AGAIN, ENSURE THAT ALL CONTROLS ARE IN THE OFF POSITION.

NEVER USE BIOLOGICAL WASHING POWDER, HARSH ABRASIVES, SCOURING PADS, AEROSOL CLEANERS OR OVEN CHEMICAL CLEANERS OF ANY KIND UNLESS SPECIFIED BELOW.

1. Plastic or nylon pads / scourers, these may scratch the surface.
2. Household abrasive powders.
3. Oven chemical cleaners, aerosols and oven pads.
Caustic cleaners such as these will etch the surface and attack the metal frame.
4. Bath and sink cleaners may mark the surface.

Ceramic hob

To reduce the amount of cleaning always ensure that the hob and cooking utensils are clean and dry before use. Regular use of cleaner conditioner is recommended for proper care and protection of the hob surface. Apply conditioner before using the hob for the first time. It contains a mild cleaning agent, so that subsequent applications may clean off soil and apply a protective film at the same time. For stubborn stains or heavy soiling use any of the following materials, and finish off with conditioner.

1. Cif, non-scratch scouring cream.
2. Liquid Gumption Kitchen Cleanser.
3. Special Powder Cleanser.

Powder Cleanser – Mineral deposits that are present in hard water, and some foods, may cause 'discolourations' that appear in the form of grey or brown stains. The stains sometimes appear to be in or under the glass surface. If there are some persistent stains after using any of the other recommended cleaning materials, powder cleanser may be applied, following the manufacturers instructions. **Do not** use abrasive cleaners or the powder cleanser on the painted metal framework.

Cleaner Conditioner – Regular use of the conditioner will make the surface easier to clean thus ensuring that years of heavy abrasive cleaning do not progressively dull the surface.

Care and Cleaning

- Grill** Remove the grill pan and the wire grid food support, it is best to wash these items immediately after use to prevent stains from being burnt on when used again. Wipe out the Grill compartment, use a fine steel wool soap pad to remove stubborn stains from the grill runners and the floor of the compartment.
- Control Panel** Wipe over the control panel with a damp cloth and polish with a dry cloth. **Do not use** cream cleaners, oven cleaners or aerosols, scouring pads or abrasive powder for cleaning the plastic knobs as damage will occur.
- Decorative Trims** It is advisable to clean the decorative trims regularly to prevent any build up of soiling. The recommended method of cleaning is to wipe over the trims with a soft cloth wrung out in warm water or mild non-abrasive cleaner. (If in doubt try the cleaner on a small area of trim which is not noticeable in normal use). Then, after wiping with a cloth wrung out in clear water, dry with a soft clean cloth.
- Doors** Wipe over the outer door glass panels with a cloth wrung out in warm soapy water, then after wiping with a cloth wrung out in clear water, dry with a soft clean cloth. **Ensure that glass doors are not subjected to any sharp mechanical blows.**
- Glass Inner Door Panel (where fitted)** – open the door fully and unscrew the two screws securing the glass panel, taking care not to allow the glass to fall. The glass panel may now be washed at the sink. Stubborn stains can be removed by using a fine steel wool soap pad. **Ensure the glass panel is not subjected to any sharp mechanical blows.** Take particular care not to damage the inner surface which is coated with a heat reflective layer. After cleaning, rinse and dry with a soft cloth. For slight soiling the inner glass panel may be cleaned, while still warm, without removing it from the door.
- Warning: Oven must not be operated with inner door glass removed.**
- Take care** during cleaning not to damage or distort the door seals. Do not lift the door seal from the oven chassis, if necessary remove the seal by carefully unhooking the corner clips.
- Take care** that the rating label edges are not lifted during cleaning, and furthermore that the lettering is not blurred or removed.

Care and Cleaning

Ovens

Remove the rod shelves and grill pan.

Use a fine steel wool soap pad to remove stubborn stains from the rod shelves, grill pan and the floor of the oven.

Oven Liners

The surface of the 'Credaclean' oven liners are treated on the mottled face with a special vitreous enamel which absorbs cooking soils. At temperatures of 220°C (425°F) or above, the special surface enables these soils to be slowly destroyed. The higher the temperature the more effective it is. In most cases normal cooking operation at this temperature will permit this cleaning operation to proceed during cooking. However if higher cooking temperatures are not used regularly it may be necessary, to prevent heavy soiling, to run the oven without a meat pan at maximum setting for a couple of hours. This may be necessary once a month or once every two or three months depending on the type and amount of oven cooking.

It should not normally be necessary to clean the 'Credaclean' panels in water. If desirable remove the rod shelves and the side panels and wash them in warm soapy water, followed by rinsing in clean water.

Oven Lamp Replacement

Open the oven door and remove the rod shelves. Using a suitable cloth to protect the fingers grip the light glass dome, unscrew anti-clockwise and lift. Reach into the aperture with fingers, and unscrew the lamp anti-clockwise. Fit replacement lamp (15W 300°C rated SES), refit dome.

WARNING: To avoid electric shocks - please ensure that the electricity supply to the appliance is switched off and the appliance is fully cold, before removing the lamp lens.

Cooking Results Not Satisfactory?

Problem	Check
Grilling Uneven cooking front to back	Ensure that the grill pan is positioned centrally below the grill element.
Fat splattering	Ensure that the grill is not set to too high a temperature.
Oven Baking Uneven rising of cakes	Ensure that the oven shelves are level by using a spirit level on the rod shelf and adjusting, using suitable packing e.g. wood, under the feet of the appliance. This should be checked both left to right and front to back. Ensure that the food is positioned centrally in the oven.
Sinking of cakes	The following may cause cakes to sink: 1. Preheat of fan ovens. 2. Cooking at too high a temperature. 3. Using normal creaming method with soft margarine.
Over/Under cooking Fast/Slow cooking	Refer to the cooking times and temperatures given in the oven temperature charts, however, it may be necessary to increase or decrease temperatures by 10°C to suit personal taste. Do not use utensils greater than 2 ¹ / ₄ ins in height.

Something Wrong with your Cooker?

**Before contacting your Creda Service Centre/Installer, check the problem guide below.
THERE MAY BE NOTHING WRONG.**

Problem	Check
Slight odour or small amount of smoke when using the cooker for the first time.	This is normal and should cease after a short period.
Nothing Works	Is the main cooker wall switch turned on? There may be no electricity supply.
Oven temperature seems too high or too low.	Check that the temperature has been set in accordance with the temperature charts. It may be necessary to increase or decrease the recommended temperature by up to 10°C to suit your taste.
Oven does not cook evenly.	Check that the temperature and shelf position are as recommended in the temperature charts. Check that the containers being used in the oven allow sufficient air flow around them. Check that the cooker is level.
Hotplates are slow to boil or will not simmer	Check that your pans conform to the recommendations in these instructions.
Marks appearing on hotplates. Can not clean hob / hotplates.	The hob surround can be cleaned with warm soapy water and a cream cleaner, such as Cif. The sealed hotplates should be cleaned regularly, (please refer to the Care and Cleaning section for further information). Please note that replacement hob cleaning kits are available from our parts department (see Back Cover for contact number).
Grill not working.	The grill door MUST be open.
Grill keeps turning on and off.	When the grill control is operated at a setting less than maximum, this is normal regulator operation, not a fault.
Condensation on the wall at the rear of the cooker.	Steam and/or condensation may appear from the vent at the rear of the appliance when using an oven particularly for foods with a high water content e.g. frozen chips, roast chicken etc. This is normal and any excess should be wiped off.
Steam / Condensation in the oven after use.	Steam is a by-product of cooking any food with a high water content. To help minimise always: a) Try to avoid leaving food in the oven to cool after being cooked. b) Use a covered container, wherever possible

If you have been through the above list and there is still a problem; Contact Service see Key Contacts (back cover).



Key Contacts

Service

Hotpoint has the largest appliance manufacturer's service team in Europe, trained specialists directly employed by us to ensure your complete confidence.

Repair Service

UK: 08709 066 066

Republic of Ireland: 1850 302 200

You will be asked for the following information:-

Name, address and postcode.

Telephone number

Model / Serial number of the appliance

Clear and concise details of the query or fault

Place and Date of purchase

(Please keep the receipt as evidence will be required when the engineer calls).

Extended Warranty

To join: UK 08709 088 088

Republic of Ireland: 1850 502 200

Genuine Parts & Accessories

Mail Order Hotline

UK: 08709 077 077

Republic of Ireland: (01) 842 6836

For further product information 08701 506070

All Hotpoint Services are offered as an extra benefit and do not affect your statutory rights.

Merloni Elettrodomestici UK Ltd, Morley Way, Peterborough, PE2 9JB

Free Manuals Download Website

<http://myh66.com>

<http://usermanuals.us>

<http://www.somanuals.com>

<http://www.4manuals.cc>

<http://www.manual-lib.com>

<http://www.404manual.com>

<http://www.luxmanual.com>

<http://aubethermostatmanual.com>

Golf course search by state

<http://golfingnear.com>

Email search by domain

<http://emailbydomain.com>

Auto manuals search

<http://auto.somanuals.com>

TV manuals search

<http://tv.somanuals.com>