

Hotpoint Service and Spares

FOR SERVICE: If you have a problem with your appliance ring your local Service Office.
 FOR SPARES and ACCESSORIES: To purchase spares and accessories send your Accessories Order Form to your Spares Centre. If the accessory or spare part you want is not on the form, contact your Spares Centre for prices and availability.
 Please address all correspondence to Hotpoint Spares Centre or Hotpoint Service Office as applicable.

Service Offices and Spares Centres are open between 8.00am-5.00pm Monday to Friday, except on Public Holidays. 8.30am-12.30pm on Saturdays.

- EAST**
- **ESSEX:** Industrial Buildings, Beehive Lane, Chelmsford, CM2 9TE. Post Codes RM & IG. Tel: (0245) 492433. Remainder of Essex Tel: (0245) 269331
 - **PETERBOROUGH:** Celta Road, PE2 9JB. Tel: (0733) 64741. Spares Administration Dept. Tel: (0733) 556620
 - **LONDON**
 - **WEMBLEY:** 68 East Lane, HA9 7PQ. Tel: 081-904 4399. S. Heris and Middlesex. Tel: 081-908 4722. Post Codes N, NW, E, EC. Tel: 081-908 4722. Post Codes W, WC, SE, SW. Tel: 081-908 2511. Tel: 081-904 0201
 - **MIDLANDS**
 - **BIRMINGHAM:** Westgate, Aldridge, W Midlands, WS9 8UX. Post Codes B Tel: (0922) 743374. All other Post Codes Tel: (0922) 743376. Tel: (0922) 743377
 - **NOTTINGHAM:** Ashling Street, NG2 3JB. Tel: (0602) 862431/864322. For Spares Tel: (0602) 860387
 - **STOKE:** West Ave, Nelson Estate, Talke, ST1 1TN. Tel: (0782) 774511
 - **NORTH EAST**
 - **WASHINGTON:** 8 Bebe House, Tower Road, Clover Est, District 11, NE37 2SH. Tel: 091-417 3500/419 3535
 - **WETHERBY:** Sandbeck Lane, LS22 4TW. Tel: (0837) 581261/581444. For Spares Tel: (0837) 581221
 - **NORTH WEST**
 - **KENDAL:** Mumford House, 26 Highgate, LA9 4SX. Tel: (0539) 724483
 - **MANCHESTER:** 44/46 Station Road, Heaton Mersey, Salford, M4 3DT. Manchester North Tel: 061-432 0513. Manchester South Tel: 061-442 8677. Tel: 061-432 0255
 - **NETHERTON:** 7 Bridle Way, Merseyside. Tel: 051-525 2342/524 2339
 - **SCOTLAND**
 - **ABERDEEN:** Holbeck House, 68 Cardon Place, AB1 1UL. Tel: (0224) 642283
 - **EDINBURGH:** 35 West Bowling Green Street, Leith, EH6 5NX. Tel: 031-554 1431
 - **RENFREW:** West Lodge Road, Blythswood Estate, PA4 9EN. Tel: 041-886 6241. For Spares Tel: 041-886 5611
 - **SOUTH**
 - **KENT:** Larkfield Trading Est, New Hythe Lane, Larkfield, ME20 6SW. CR DA, ME & TN Kent Post Codes Tel: (0622) 716571. CR, KT, RH, SM Surrey & BR Kent Post Codes (0622) 730707. GU Post Codes in Surrey Tel Southampton: (0703) 667374. Tel: (0622) 716631
 - **SOUTHAMPTON:** Unit R, S. Hampshire Ind Park, Salisbury Rd, Tonton, SO4 3SA. Tel: (0703) 861981/867374. For Spares Tel: (0703) 867393
 - **SUSSEX:** 1 Kingswood, North St, Hailsham, BN27 1DQ. Tel: (0323) 842733
 - **PLYMOUTH:** 69 Mulvey Plain, PL4 6JH. Tel: (0752) 262631
 - **WALES**
 - **NORTH:** Conwy Rd, Llandudno Junction, LL31 9RE. Tel: (0492) 573536
 - **SOUTH:** 18 Western Ave, Bridgend Ind Estate, Bridgend, CF31 3SL. Post Codes BS, GL, (incl 95), HR, SY15-18, LD1-8, NP. Tel: (0656) 655554. Tel: (0656) 766111

In accordance with its policy of progressive product design, the Company reserves the right to alter specifications. Hotpoint Ltd, Peterborough, PE2 9JB, England

HOTPOINT SLOT-IN COOKER

USER HANDBOOK AND INSTALLATION INSTRUCTIONS MODEL 6505 MK II

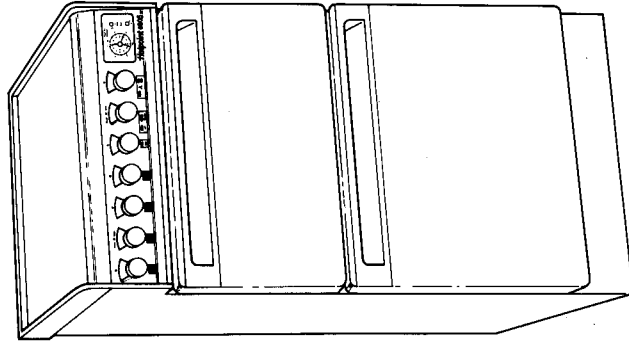

Hotpoint®

Retention of this Instruction Book

This Instruction Book must be kept handy for reference as it contains important details on the safe and proper use of the appliance.
 If you sell or pass the appliance to someone else, or move house and leave it behind, make sure this Book is also provided so the new owner can become familiar with the appliance and safety warnings.
 If the Book is lost or damaged a copy may be obtained from Hotpoint Ltd, Celta Road, Peterborough, PE2 9JB.

- Service Office and Spares Centre
- Service Office only

<p>IRELAND</p> <ul style="list-style-type: none"> • NORTHERN: 256 Ormeau Road, Belfast, BT7 2Z. Tel: (0232) 647111. 49 Airways Ind. Estate, Dublin 17. Tel: Dublin 426088. Tel: Dublin 426836 • EIRE: For Service For Spares 	<p>CHANNEL ISLANDS - Service provided by Agents. Normal Guarantees apply and all Service Schemes are available.</p> <p>JERSEY: 19 Don Street, St. Helier. Tel: (0534) 21825. Clos D'Ormes, Pontac, St Clements. Tel: (0534) 54608</p> <p>or</p> <p>GUERNSEY & SARK: Valpys Stores, Grande Rue, St. Maurens, Guernsey. Tel: (0481) 38422</p> <p>or</p> <p>Borras Lane, Vale. Tel: (0481) 51610</p> <p>32 High Street. Tel: (0481) 822696</p>	<p>ISLE OF MAN - Service provided by Agents. Normal Guarantees apply and all Service Schemes are available</p> <p>from</p> <p>5 Drumgoff St., Douglas. Tel: (0624) 67323</p> <p>or</p> <p>Tremode Works, Cronkbourne Village, Douglas. Tel: (0624) 676066</p> <p>or</p> <p>17 Ridgeway Street, Douglas. Tel: (0624) 25811/25848</p>	<p>SHETLAND, ORKNEY & WESTERN ISLES - Service provided by Agents. Normal Guarantees apply, but Service Schemes are NOT available.</p> <p>SHETLAND: Fort Road, Lewis. Tel: (0938) 2557</p> <p>ORKNEYS: Halsione Ind. Estate, Kirkwall. Tel: (0856) 5457</p> <p>WESTERN ISLES: 27 Bayhead Street, Sornaway, Isle of Lewis. Tel: (0851) 3387</p> <p>OTHER ISLANDS: Local Hydro Electric Shops</p> <p>EXCEPT ARRAN, BUTE & SKYE - Which are covered by Hotpoint.</p>
---	--	--	--

Before you operate your new Hotpoint Slot-In Cooker

Please read these instructions fully.

ENSURE THAT THE COOKER IS INSTALLED BY A QUALIFIED ELECTRICIAN FOLLOWING THE INSTRUCTIONS BELOW.

1. Your cooker should **not** be located adjacent to a gas heater as flames from the burners could cause damage to your cooker.
2. For your own safety and to get the best results from your cooker it is important to read through this Handbook **before** using your cooker for the first time.

Installation

- **Unpacking the appliance**
The cooker should be carefully unpacked and checked for damage. Ensure that no packaging material is left inside the oven cavities.
- **Siting the Cooker**
The cooker is designed to be flush between standard kitchen units spaced a minimum 500mm apart. The clearance either side need only be sufficient to allow withdrawal of the cooker for servicing. It can be used with cabinets on one side or both, as well as in a corner setting. It can also be used freestanding. Adjacent side walls which project above hob level should be protected by heat resistant material, but in any case should not be nearer to the cooker than 100mm. Any overhanging surface or cooker hood should not be nearer than 650mm.

WARNINGS – ENSURE THAT THE OVEN IS INSTALLED WITHIN THE RECOMMENDED MEASUREMENTS. THIS ALLOWS SUFFICIENT VENTILATION AROUND THE OVEN PREVENTING A BUILD UP OF HEAT WHICH COULD CAUSE PROBLEMS WITH ADJACENT KITCHEN UNITS.

- Any electrical wiring must be carried out in compliance with the appropriate IEE and electricity company regulations by a qualified electrician, eg. your local electricity company or a contractor who is on the roll of the National Inspection Council for Electrical Installation Contracting (NICEIC).
- **WARNINGS – INCORRECT INSTALLATION COULD AFFECT THE SAFETY OF THE APPLIANCE.**
 - THIS APPLIANCE MUST BE EARTHED.
 - BEFORE CONNECTING OR INSTALLING THE COOKER THE ELECTRICITY SUPPLY MUST BE SWITCHED OFF.
- **IMPORTANT: The earth connection on this appliance must be made using a box spanner to avoid strain on adjacent terminals.**
- The installer **must** check that the voltage shown on the rating plate corresponds with the house electricity supply.
- The cooker **must** be connected to a suitable double pole isolating switch (cooker control unit) having a contact separation of at least 3 mm in all poles placed in a readily accessible position adjacent but not directly above the cooker.
- Access to the mains terminals is gained by removing the rear access cover.
- The mains cable must pass through the cable clamp adjacent to the terminal block. Sufficient cable should be used to allow the cooker to be pulled out for servicing.
- The main cooker control unit **must** be switched **ON** for any part of the cooker to function. In houses fitted with a 30 milliamp RCCB, the combined use of your slot-in cooker and other domestic appliance may occasionally cause the RCCB to trip. In the unlikely event of the RCCB repeatedly tripping contact your local Hotpoint Service Office. In some instances it may be necessary to fit a 100 milliamp RCCB.
- **Height Adjustment:**
The delivered height of your cooker is set at 902mm to the top of the hob side trims. The minimum height of the cooker is 900mm if the plastic feet under the plinth are removed, with care, using a suitable tool. Levelling washers/height adjustment washers – 1 x 10mm and 1 x 2mm for each foot (packed in a polythene bag) are provided for use when the cooker is sited on an uneven floor. You can increase the height, by plugging the levelling washers into the plastic feet (under the plinth) to 902, 904, 910 or 912mm to ensure that the cooker is level and does not 'rock'. As the cooker is heavy a second person should hold the cooker whilst it is lifted backwards to gain access to the feet.
The cooker should not be installed with the hob height below the worktop height.
Before sliding the cooker into position, measure that height of the units next to the cooker from the floor to the worktop at front and back.
Lower top oven door, place hands on the top oven roof avoiding any damage to the grill elements and carefully locate cooker into position.
Check the level of the cooker by placing a spirit level on the top of the cooker fascia taking care not to scratch the surface. Make any adjustments necessary.
The maximum loading of your cooker is 10.9kW.

NOTE: Children should not be allowed to play with the appliance or tamper with the controls. DO NOT allow children near the appliance when in use as surfaces will get extremely hot.

Hotpoint Service Cover

Satisfaction Guaranteed or Your Money Back

Hotpoint gives you a unique 'Satisfaction Guaranteed' promise – valid for ninety days after you have purchased your Hotpoint product. If there is a problem with your Hotpoint appliance just call your Hotpoint Service Office. If necessary we will arrange for an engineer to call. If the problem is not resolved by us under this Guarantee, Hotpoint will replace your appliance or, if you prefer, give you your money back. This Guarantee is additional and subject to the terms of Hotpoint's Five Year Parts Guarantee.

Hotpoint's Free Five Year Guarantee

From the moment your appliance is delivered, Hotpoint guarantees it for **FIVE YEARS**.

- In the Five Years all replacement parts are **FREE** provided they are fitted by our own Service Engineer. During the first year our Engineer's time and labour is also free.
- After the first year we will charge for our Engineer's time and labour. We do, however, operate a range of Service Plans (see opposite) which for an annual payment enables you to cover any repair costs which may be necessary.
- All of our service repairs are guaranteed for twelve months in respect of our labour and any parts fitted.
- The appliance must be used in the United Kingdom and must not be tampered with or taken apart by anyone other than our own Service Engineer.
- You may, however, buy parts which can be safely fitted without specialist knowledge or equipment. The correct fitting of such parts, provided they are genuine Hotpoint spares, will not affect your Guarantee. Parts are available from our main Hotpoint Spares Centres (see back page).
- Our Guarantee does not cover the cost of any repair which is needed because of power cuts, accidents or misuse. Nor does it cover the cost of any visit to advise you on the use of the appliance. Please read the instruction book thoroughly.
- If at any time during the Guarantee period we are unable to repair your appliance, we will refund any repair costs paid to us in the previous twelve months. We will also offer you a new appliance at a reduced charge instead of a repair.
- Our Guarantee is in addition to and does not affect your legal rights.
- Should you need independent advice on your consumer rights, help is available from your Consumer Advice Centre, Law Centre, Trading Standards Department and Citizens Advice Bureau.

- All Hotpoint servicing is done by our own Service Organisation located throughout the United Kingdom and Southern Ireland. It will be happy to deal with any problems.

Hotpoint's Service Care

Whether you have just one or a number of Hotpoint appliances in your kitchen, Hotpoint has a range of Service Schemes to give you complete peace of mind.

Service Cover

A single payment covers you for all repairs during the period of cover, which can be from 1 to 4 years. There is also an option of Service Cover with Maintenance at an additional cost. This includes an annual Electrical and Safety check and replacement of any parts as necessary. For 1 year contracts this takes place towards the end of the contract period.

Kitchen Cover

An annual payment covers you for all repairs for all your Hotpoint appliances which are less than 10 years old. It also covers the cost of loss of food up to £250 in our refrigeration and freezer products. There is also the option of Kitchen Cover with Maintenance at an additional cost. Any additional Hotpoint appliances purchased after you have joined Hotpoint Kitchen Cover will automatically be included during the annual period of cover without further charge.

Appliance Registration

To ensure that you have the opportunity to benefit from any of the above Service Schemes you should complete and return immediately the Appliance Registration Form supplied with your appliance. Full details and costs of our Service Schemes together with an application form will be sent to you at the end of the first year of the guarantee.

Annual Safety/Maintenance Checks

Hotpoint strongly recommends that all its appliances are regularly checked for electrical and mechanical safety whether or not they are covered by a Service Plan.

Proof of Purchase

For future reference please attach your purchase receipt to this booklet and keep it in a safe place.

Spares and Accessories

Spares and accessories can be ordered from your local Hotpoint Spares Centre (listed on the back page), using the order form enclosed.

NOTE: Our Engineer will use every effort to avoid damage to floor coverings and adjacent units when carrying out repairs/service work but in locations where the Engineer advises you that it will be impossible to move the appliance without risk of damage, he will only proceed with your approval that no liability is accepted.

Contents

Before you operate your new Hotpoint Slot-In Cooker	Page 2
The main parts of your Cooker	4
The cooking systems in your Cooker	5
The Controls	6-7
The Timer	8-9
Hotplates	10-11
Top Oven – Grilling	12
Top Oven – Conventional Cooking	13
Top Oven – Temperature Chart	14-15
Main Oven – Fan Cooking	16
Temperature Conversion Chart	17
Care and Cleaning of the Cooker	18-20
If something goes wrong	21
If it still won't work	21
Hotpoint Service Cover	22
Hotpoint Service Offices and Spares Centres	back cover

The Main Parts of your Cooker

WARNING: DO NOT TOUCH THE OVEN DOORS WHEN THE OVEN IS IN USE AS THESE AREAS CAN BECOME HOT.

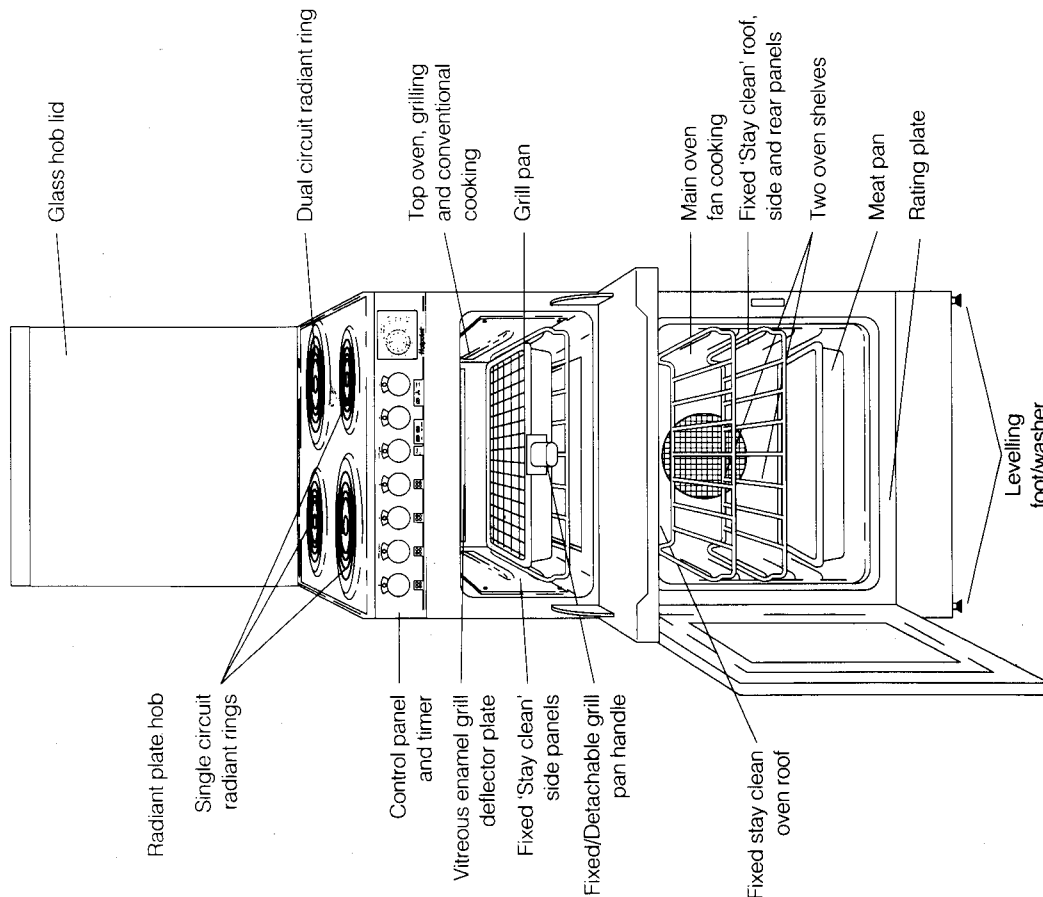

If something goes wrong...

First, don't panic! There may be nothing wrong. Check the points below become calling your Hotpoint Service Office.

1. Check that the mains supply is switched on.
2. Check that the Automatic Cooking Programmer has not been selected; if it has, switch the oven back to Manual control (see page 10).
3. If using the Grill in the Top Oven make sure that the Top Oven Control is set to 'O' Off (see page 6).

If it still won't work...

Contact the Service Office

If there is still a problem with your Cooker after checking the points above:

1. Switch off the Cooker at the cooker control panel.
 2. Call your nearest Hotpoint Service Office or local importer (outside the UK). The telephone number is shown on the back page. Note the number down in the space below:
-

Spare Parts

Please remember your new appliance is a complex piece of equipment. 'DIY' repairs or unqualified and untrained service people may put you in danger, could damage the appliance and might mean you lose cover under Hotpoint's Parts Guarantee.

If you do experience a problem with the appliance don't take risks; call in Hotpoint's own Service Engineer. The address and telephone number of your nearest Hotpoint Service Office is in your local telephone directory. Our spare parts are designed exclusively to fit only Hotpoint appliances. Do not use them for any other purpose as you may create a safety hazard.

When you contact us we will want to know the following:

1. Your name, address and post code.
2. Your telephone number.
3. Clear and concise details of the fault.
4. The model number (6505 Mk.II), serial number (situated on the front of the cooker below the main oven door) and the colour.
5. The date of purchase. Enter the date here:
6. If you have taken out one of the Hotpoint Service Schemes.

Please make sure you have these ready when you call.

Decorative Trims

It is advisable to clean the decorative trims regularly to prevent any build up of soiling which may detract from the appearance of the cooker. The recommended method of cleaning is to wipe over the trims with a soft cloth wrung out in hot water, or mild non-abrasive cleaner. (If in doubt try the cleaner on a small area of trim which is not noticeable in normal use), then after wiping with a cloth wrung out in clean water, dry with a soft clean cloth.

Cleaning the Exterior of the Cooker

The outside of the cooker should be cleaned regularly to keep it looking like new.

Wipe over with a soft cloth wrung out in hot water and dry with a soft clean cloth.

You can use mild non abrasive cleaners but always read the manufacturer's instructions first. Always test their suitability on a small area of the cooker not noticeable in normal use.

NOTE: DO NOT use scouring pads or abrasive cleaners which will scratch the glass.

Replacement of the interior, main oven light

WARNING: BEFORE REPLACING THE OVEN LIGHT, SWITCH COOKER OFF AT THE COOKER ISOLATOR SWITCH (and allow the oven to cool if it has been used).

Protect hand with oven glove or thick cloth and unscrew the glass cover and remove carefully. Unscrew the existing light bulb and remove. Screw the new bulb into position and replace the glass cover until positioned securely.

The cooking systems in your Cooker

Your new cooker is equipped with different cooking systems:

1. **Conventional Heating** [Top Oven] – with upper and lower heat. This system is particularly suitable for roasting and baking on one shelf only.

2. **Variable Grilling** [Top Oven] – the oven can also be used for conventional grilling with a full or half width fully controllable grill.

Note: The Top Oven Door must be open when grilling.

3. **Fan Cooking** [Main Oven] – the fan oven operates by constantly blowing heated air, from an element wrapped around the fan, into the oven. This gives improved efficiency and, in general, enables the use of lower temperatures for cooking. It also means that there is less need to be particular about shelf positions and that you can bake at more than one level simultaneously (Batch Baking).

These three systems of cooking are described more fully in the separate Recipe Book and we would suggest you read right through the Introductory Section of that book **before** using the oven.

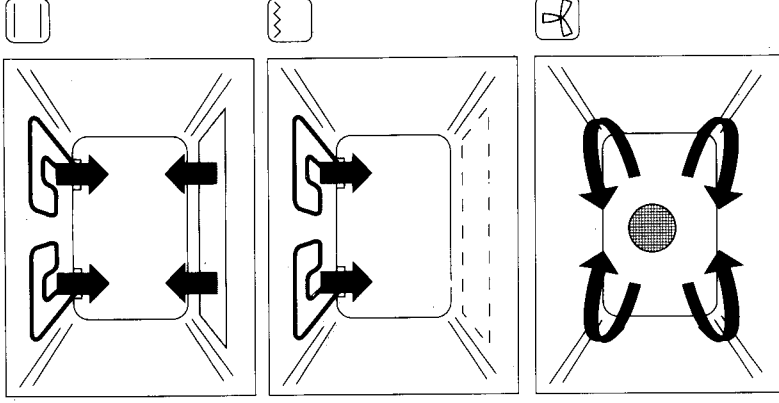

PLEASE NOTE that when the cooker is used for the first time a slight odour may be emitted due to the 'burning off' of any temporary finish on oven fittings and elements and the removal of moisture absorbed by the lagging. The odour will cease after a short period of use.

Ensure that the room is well ventilated (eg open a window or door) and that persons who may be sensitive to the odour avoid any fumes. It is suggested that any pets be removed from the room until the 'new smell' has ceased.

The Controls

Switch on the electricity supply to the cooker at the Cooker Control Unit.

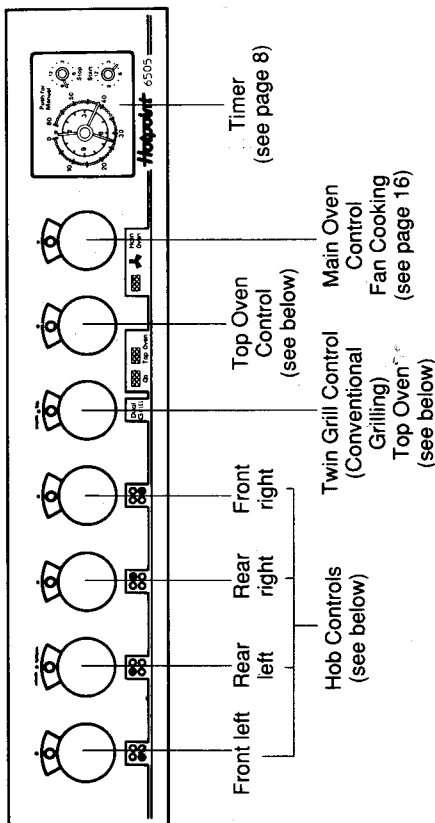

Hob Controls

Turning the control knob clockwise progressively increases the power, HI denoting the 'full on' position.

Setting Hi is the highest/hottest and gives 100% power. Setting Lo is the lowest/coolest and gives about 7% power (see page 10 for ratings). Variable power is obtainable on each of the heating areas by selecting any number between 1-4 and Hi. The 'off' position is identified by a red 'O'. The control knobs for the hob heating areas can be rotated in either direction to provide fully variable heat control.

Grill Control – Top Oven

The grill will not operate unless the top oven control is in the 'O' off position.

The grill control provides fully variable heat control for either the twin grill or single (left hand side) grill by

NOTE: Do not use enzyme or biological washing powder, harsh abrasives or chemical oven cleaners of any kind.

Do not wash them in a dishwasher.

Oven Fittings

The shelves can be removed for cleaning either in a dishwasher or by using a fine steel wool soap pad.

The grill and meat pans can be cleaned either in warm soapy water using a fine steel wool soap pad to remove stubborn stains or in a dishwasher. They should be cleaned after each user.

Oven Door Cleaning

The Top Oven door is removable to facilitate the occasional cleaning of heavy soiling from the oven floor and from the door itself.

To remove, open the top and main oven door fully and, using a coin or screwdriver, turn the two discs anti-clockwise to the position shown below (Fig. a). Part-close the door to approx. 45°, unhook the lower hinge fingers upwards, then pull the door away from the body of the cooker.

To replace, insert the lower fingers and hooked ends of the door stays, ensuring that the slots in the lower fingers engage with the front frame (Fig. b). Fully open the door and turn the discs clockwise to their normal working positions (Fig. c).

NOTE: Take care not to trap your fingers. Ensure that assistance is at hand should it be required.

Wipe over with a soft cloth wrung out in hot soapy water and dry with a soft clean cloth. Wear protective gloves.

DO NOT use scouring pads or abrasive cleaners as they may scratch the surface.

Oven Interiors

To clean the oven interiors remove all the oven fittings.

All types of oven cleaners can be used, but **do not** allow abrasive cleaners or oven spray to come into contact with the 'Stay Clean' liners. Use a fine steel wool soap pad to remove stubborn stains.

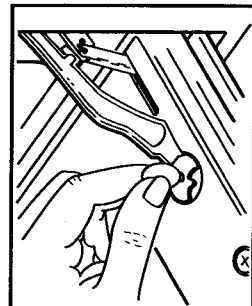

Fig. a

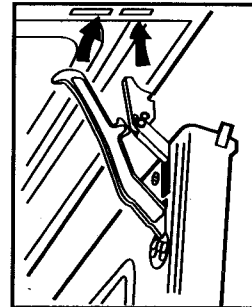

Fig. b

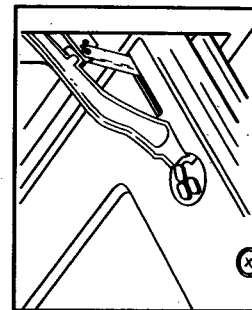

Fig. c

selecting any number between 1 to 4 and Hi.

When turned clockwise the twin grill will be switched on and any power setting from 1 to 4 and Hi can be selected. The power level numbers are indicated in black on red background. When turned anti-clockwise the single grill will be switched on and any power level from 1 to 4 and Hi can be selected. The power level numbers are indicated in black on green background. The 'off' position is identified by a red 'O'.

Top Oven Control

This control switches on the top and bottom heating elements in the top oven.

The temperature in the top oven can be set anywhere between 100°C and 220°C.

The 'Top Oven On' indicator light (left hand side) will glow and remain on until the top oven control is turned off.

Care and Cleaning of the Cooker

WEAR PROTECTIVE GLOVES WHEN CLEANING ANY PART OF YOUR COOKER.

WARNING: BEFORE CLEANING SWITCH THE COOKER OFF AT THE COOKER ISOLATOR SWITCH AND ALLOW IT TO COOL.

IT IS ESSENTIAL THAT OVENS ARE CLEANED AND KEPT FREE FROM FATS; OIL AND GREASE.

Glass Lid

Remove by lifting when the lid is in the vertical position. When refitting ensure the hinges are correctly fitted into the rear trim.

Clean with hot soapy water, then after wiping with a cloth wrung out in clean water, dry with a soft cloth.

Do not use scouring pads or abrasive powders which may scratch the surface. The glass lid must not be subjected to sharp mechanical blows during normal use and cleaning operations.

It is necessary to remove any spillage from the surface of the cover before opening.

Hotplates

The chrome bezels lift off for cleaning. The hob lifts for cleaning. Spillage which collects in the spillage tray should be wiped up as quickly as possible.

Hob and Spillage Compartment

Lift out the hotplate bezels and wash in hot soapy or detergent water. To clean the spillage compartment, raise the hob and secure in this position with the stay provided, and wipe with a damp cloth wrung out in hot soapy or detergent water, using a fine soap impregnated steel wool pad if necessary.

Control Panel

Wipe over the control panel with a damp cloth and polish with a dry cloth. **Do not** use oven cleaners or aerosols, scouring pads or abrasive powder for cleaning the glass, plastic knobs or plastic end caps as damage will occur.

Grill

Remove the wire grid food support and grill pan, it is best to wash these items immediately after use to prevent stains from being burnt on when used again. Wipe out the grill compartment, use a fine steel wool soap pad to remove stubborn stains from the grill deflector plate, the rod shelf, the floor and the rear wall of the compartment.

'Stay Clean' Liners

'Stay Clean' liners are fitted to the sides of the Top Oven, and to the roof, sides and back of the Main Oven.

'Stay Clean' liners are covered with a special enamel which absorbs cooking soils. At higher temperatures the soiling is slowly destroyed. In most cases normal cooking at higher temperatures will permit this cleaning to take place automatically.

However, if higher cooking temperatures are not used regularly then it may be necessary, in order to prevent heavy soiling, to run the oven at maximum temperature for at least two hours, from time to time.

Should it be necessary, the 'Stay Clean' sides and back panels can be removed by unscrewing each panel. The 'Stay Clean' liners can then be washed in warm soapy water followed by rinsing in clear water. Dry well with a soft cloth.

The red thermostat light (right hand side) will glow initially and remain on until the oven reaches the required temperature. It will then cycle off and on as the oven thermostat maintains the correct temperature.

The 'off' position is identified by a red 'O'.

The top oven control can only be turned clockwise.

Main Oven Control

This control switches on the Main Oven.

Notes

- 1. Never operate both the grill control and top oven control together. The grill will not operate unless the top oven control is in the 'O' off position.**
2. If either oven does not switch on when the control is turned check that the timer is in Manual operation (see page 8).
3. To remove the oven shelves – pull the shelf towards the user. Lift the shelf slightly and withdraw. To replace – lift the shelf and ensure that the shelves are firmly in position between the shelf runners. Lower the shelf and push into position.

The Timer and its operation

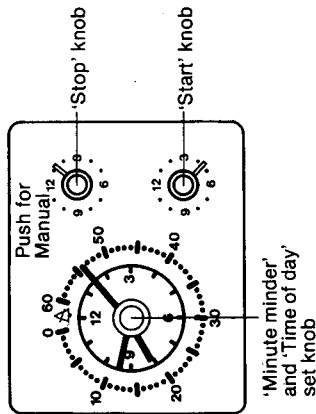

The Timer can be used to control both ovens automatically. When the control has been set for one oven, the other can only be used on the same cooking programme for the same time.

Hints on Automatic Cooking

1. Select foods which will take about the same time to cook, and require approximately the same oven temperature.
2. Foods which discolour should be protected by coating in cooking oil, or tossing in water to which lemon juice has been added.
3. Foods should be well sealed in dishes, to prevent the loss of liquid during cooking. Aluminium foil makes a good seal.

Switching On – manual operation
1. Make sure the cooker is switched On at the main cooker control unit.

1. Ensure that the 'stop' button is pushed in.

1. Setting Time of Day. The timer is controlled by the electric clock. To set the clock to correct time, press and rotate the knob in the centre of the minute minder dial. (NB. Ensure that the minute minder pointer remains at, or is returned to the **Off** position.)

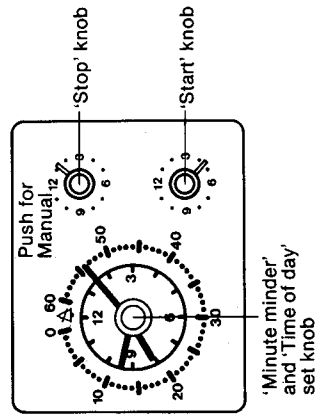

2. To set the Timer to switch ON and OFF automatically.

1. Set the start time by pressing the **Start** knob and turn the pointer to the time to start cooking.
2. Set the stop time by pressing the **Stop** knob and turn the pointer to the time to stop cooking. The stop time should be ahead of the start time by the total time it will take the food to cook.
3. Turn the oven control to the required cooking temperature.
4. The oven will be automatically switched **On** at the pre-selected time and switched **Off** when the cooking time has expired.
5. When the meal has been cooked, always turn the oven thermostat control to the **Off** position, and press the **Stop** control knob to return to **Manual Control**.

Temperature Conversion Chart

Conventional Electric		Slot-In Fan Mode	Gas Mark
°F	°C	°C	
200°	100°	80°	1/4
225°	110°	90°	1/4
250°	130°	110°-120°	1/2
275°	140°	120°	1
300°	150°	130°-140°	2
325*	160°	140°	3
340°-350°	170°-180°	160°	3-4
350°-375°	180°-190°	160°-180°	4-5
375°-400°	190°-200°	170°-190°	5-6
400°-440°	200°-225°	190°-200°	6-7
450°-500°	230°-250°	210°-220°	8-9

Temperatures

The recommended temperatures given are for conventional and fan ovens. When using a fan oven it will be necessary to reduce the cooking time by 10 minutes per hour, and lower the temperature by up to 30°C. Also, in the majority of cases, it is not necessary to pre-heat the oven. However, pre-heating is recommended when cooking items which require less than 25 minutes cooking time and such items as Yorkshire puddings, whisked sponges and bread. Your experience with the cooker will enable you to select the cooking time and temperature best suited for your recipe.

Condensation

Condensation may become evident on the inner door and water may drip through the vent. This is normal when heat and moisture are present and may be a result of any of the following:

1. Kitchen temperature and ventilation.
2. The moisture content of the food eg meat, roast potatoes, Yorkshire pudding, roasting meat, etc.
3. The quantity of the food being cooked at any one time.

Main Oven – Fan Cooking

The heat for Fan Cooking in the Main Oven is provided by an element situated at the back of the oven, around the fan.

Fan cooking is ideal for large poultry or joints of meat, reducing cooking times and often eliminating the need for preheating the oven. It is also ideal for batch cooking where food is cooked on more than one level, because the forced circulation of hot air gives an even temperature from the top to the bottom of the oven.

The operation of the controls is covered on pages 6 and 7. Detailed charts covering suggested temperatures and shelf positions for Fan Cooking are given in the recipe book supplied.

NOTE: WHEN THE MAIN OVEN IS IN USE THE TOP OVEN INTERIOR AND SURFACES BECOME HOT.

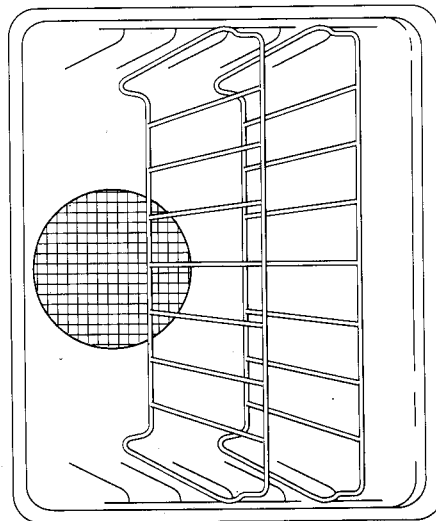

To use the oven proceed as follows:

- Set the Main Oven control to the required temperature. Pre-heating is not normally necessary, but some foods such as bread, scones and Yorkshire pudding do benefit from being placed in hot oven (see recipe book supplied).
- Place the food to be cooked in the centre of each shelf to allow for even air circulation around the food. The shelf provided in the top oven can be used as a third shelf in the Main Oven.
- When roasting use the anti splash tray beneath the meat to avoid excessive splashing of the oven.

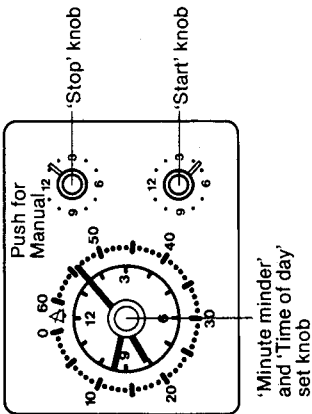

Important
Before using your ovens in the ordinary way, ALWAYS make sure that the timer has been set to MANUAL operation (see paragraph below left). Unless this is done, the oven cannot heat up. Before seeking assistance, make sure you have done this.

Minute Minder

The minute minder gives an audible reminder for short period cooking. It can be set for a period of up to 60 minutes. Turn the knob (do not press) in the centre of the minute minder dial anti-clockwise to set the pointer against the minutes required marked on the dial. The minute minder will buzz when the time set has elapsed. To switch off turn to **Off** ⚡.

3. To set the Timer to switch OFF only.

1. Set the **Stop** knob (as in 2. on page 8) at the time the food should stop cooking.
2. Press the **Start** knob. **Do Not Turn.** (NB. The knob will spring forward to its original position.)
3. The oven will be automatically switched **Off** when the pre-selected time has expired.
4. When the meal has been cooked, always turn the oven thermostat control to the **Off** position, and press the **Stop** control knob to return to **Manual Control**.

4. To cancel the Timer and return to MANUAL operation.

It may be necessary to use the oven manually after a timed operation has been set up. To cancel out the timer, turn the **Start** knob and the **Stop** knob to the time of day, ie. to read the same as the clock. Return the cooker to **Manual** operation by pressing the **Stop** knob.

Hotplates

Hob

Glass Lid

The glass lid must be opened to a vertical position before use. Before closing remove all pans from the hob and ensure that the radiant plate controls are all switched to the 'O' off position.

The hob must be allowed to cool before closing the lid.

The lid should normally be closed when the hob is not in use. The toughened glass is not intended as a work surface and should not be used for the purpose.

The lid can easily be removed for cleaning purposes, see page 18.

How to use the Hob

The control knobs for the hotplates can be turned in either direction to give variable heat control.

Ratings of Hotplates

Front left	1800W Radiant 180mm diameter
Front right	1100W Radiant 145mm diameter
Back left	1100W Radiant 145mm diameter
Back right	1800W Dual radiant 180mm diameter

Use of the Hotplates

Hotplates can only be energised when the glass lid is in the vertical position.

Turn the control knob to **Hi** for fast cooking.

To reduce the heat to cook more slowly or simmer, turn the knob to a lower setting, which will vary

according to the size of the saucepan and the amount of liquid. The two small hotplates are specially for smaller pans, low temperature cooking and simmering.

The right rear twin circuit hotplate is designed so that the whole hotplate can be used for cooking with larger pans when the control knob is turned clockwise; when the control knob is turned anti-clockwise only the inner part of the hotplate is switched on – this feature saves energy and is also useful for cooking with smaller pans on slow simmering.

Never leave a hotplate switched on without a pan as this wastes energy and will shorten the life of the hotplate.

Choice of Saucepans

For the best results, and to ensure quick economical cooking we recommend the use of **flat bottomed saucepans** (with close fitting lids) which completely cover the hotplate – up to 255mm (10in) base diameter on 180mm (7in) plate. Thin based saucepans are uneconomical since they distort in use, resulting in poor contact and efficiency.

Never place anything between the saucepan base and hotplate (ie. cooking mats etc.)

Never use recessed or ridged base utensils.

Do not line spillage tray beneath the hotplates with aluminium foil, since this will cause premature failure of hotplates.

Do not place large preserving pans or fish kettles across two hotplates as this will damage the hob.

Top Oven Temperature Chart

Meat

Food	Temperature and Time	Position in Oven
Beef/Lamb (slow roasting)	170/180°C approx. 35 mins per 450g (1lb) + 35 mins. over	Shelf placed directly on floor of oven.
Beef/Lamb (foil covered)	190/200°C approx. 35-40 mins. per 450g (1lb)	
Pork (slow roasting)	170/180°C approx. 40 mins. per 450g (1lb) + 40 mins. over	
Pork (foil covered)	190/200°C approx. 40 mins. per 450g (1lb)	
Veal (slow roasting)	170/180°C approx. 40-45 mins. per 450g (1lb) + 40 mins. over	
Veal (foil covered)	190/200°C approx. 40-45 mins. per 450g (1lb)	
Poultry/Game (slow roasting)	170/180°C approx. 25-30 mins. per 450g (1lb) + 25 mins. over	
Poultry/Game (foil covered)	190/200°C approx. 25-30 mins. per 450g (1lb)	
Casserole Cooking	Approx. 150°C 2-2½ hrs.	

If using aluminium foil, never 1. Allow foil to touch sides of oven.
2. Cover oven interior with foil. 3. Cover oven shelves with foil.

Top Oven Temperature Chart

NOTE: Baking trays or tins used to bake bread, cakes, pastry, scones, etc., always remember to place the dish, tin or tray centrally under the grill element, this will ensure an even cooking result. Covered foods such as meat, casseroles, vegetables, etc., can be placed anywhere on the rod shelf. When cooking different foods at the same time select those which require approximately the same temperatures.

If soft tub margarine is used for cake making, temperatures recommended by the manufacturers should be followed. Temperatures recommended in this chart refer to cakes made with block margarines or butter only.

Baking

Food	Temperature and Time	Position in Oven
Scones Small Cakes	210°C approx. 9-12 mins. 180°C approx. 15-20 mins.	Runner 1 from bottom of oven
Victoria Sandwich	170°C 6 1/2" tins approx. 20 mins.	Runner 1 from bottom of oven
Sponge Sandwich (fattess)	180°/190°C approx. 15 mins.	Runner 1 from bottom of oven
Swiss Roll	190°/200°C 9-12 mins.	Runner 1 from bottom of oven
Semi-rich Cake (large)	160°C 6 1/2" to 7" tins 1 to 1 1/4 hrs.	Shelf placed directly on floor of oven
Rich Fruit Cake	140°C 7"-8" tins 2-2 1/4 hrs.	
Shortcrust Pastry (Plate Tarts)	190°/200°C 40-45 mins.	Shelf placed directly on floor of oven
Puff Pastry	200°/220°C Time depending on use	Runner 1 from bottom of oven or shelf placed directly on floor of oven
Yorkshire Pudding	200°C approx. 40-45 mins.	Runner 1 from bottom of oven
Individual Yorkshire Puddings	200°C approx. 25 mins.	Runner 1 from bottom of oven
Milk Puddings	140°C 2-2 1/2 hrs.	Shelf placed directly on floor of oven
Baked Custard	150°C 40-45 mins.	Runner 1 from base of oven
Bread	210°C for 10 mins. 200°/210°C for approx. a further 30 mins.	Shelf placed directly on floor of oven
Meringues	100°C large 3 1/2-4 hrs. 110°C small 2 1/2-3 hrs.	Runner 1 from bottom of oven

Safety Requirements for Deep Fat Frying

The following recommendations should be followed:

- Never** leave the pan unattended on the heat, eg. to answer the telephone.
- Always use a deep pan large enough to cover the hotplate.
- Never** fill the pan more than one third full with oil or fat. On no account mix oil and fat.
- Do not** overload the pan by trying to fry too much. The pan containing oil and food should not be more than two thirds full.
- Always dry food thoroughly before frying and lower it slowly into the oil.
- Do not** use a lid on the pan.
- Always keep the outside of the pan clean and free from fat and oil.
- Do not** allow excessive splashing of oil onto the hob.

In the event of fire follow these steps:

- If a saucepan or chip pan catches fire **TURN OFF THE HEAT IF SAFE TO DO SO**, using the control on the front of the cooker. **DO NOT** attempt to move the pan, this may cause the fire to spread to other areas.
- Smother flames with a **DAMP CLOTH** or **FIRE BLANKET** if it is safe to do so. When smothering the flames **DO ENSURE** that your **FACE AND ARMS** are **WELL PROTECTED** from the flames to save you from becoming hurt.
- After the fire has been extinguished **DO NOT MOVE OR TOUCH** the pan for at least 30 minutes.
- If you **FAIL** to put the fire out call the fire brigade immediately.

Top Oven – Grilling

GRILLING MUST BE DONE WITH THE TOP OVEN DOOR OPEN. CONTROL KNOBS MAY BECOME HOT DURING GRILLING.

CAUTION: ACCESSIBLE PARTS WILL BECOME HOT WHEN THE GRILL IS USED — CHILDREN SHOULD BE KEPT AWAY.

The operation of the grill controls is covered on page 6. Remember that the grill will not operate until the Top Oven control is in the 'O' off position.

- Open the Grill/Top Oven door.
- When toasting or grilling, the rod shelf should be placed in either the first or second runner from the bottom.
- Preheat the grill on setting HI for approximately 5 minutes, using either the half or full width setting depending upon the amount of food to be cooked (see page 6).

Fixing the grill pan handle.

Ensure that the handle is secure before use (see Figs. 1, 2 and 3 below). The food to be cooked should be placed on the grill pan/grill pan grid. Place the grill pan on the shelf and push back until the grill pan is correctly positioned beneath the grill element.

Fixing the Grill Pan Handle

The grill pan handle is detachable from the pan, to facilitate cleaning and storage. Fix the grill pan handle securely in position before use. The handle fits onto the grill pan edge with the small recess; Fig. 1.

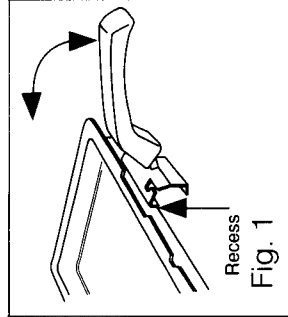

Fig. 1

Always fit screw prior to use.

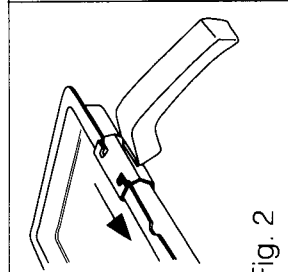

Fig. 2

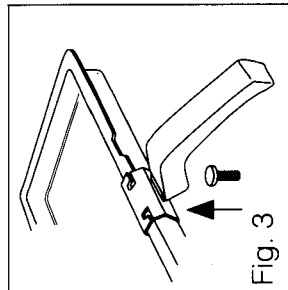
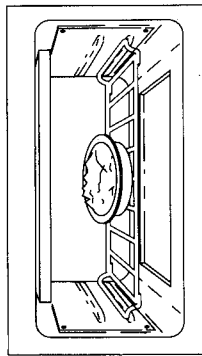
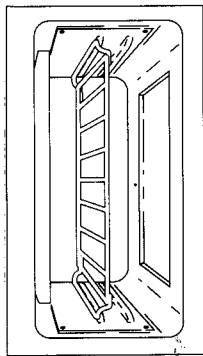

Fig. 3

Tilt the handle over the recess and slide it towards the centre, Fig. 2. Ensure the handle is fully located, Fig. 3. Insert the washer and fixing screw and tighten fully to ensure handle is secured, Fig. 3.

- Food which only requires browning should be placed directly on the shelf in the first runner from the bottom.
- Leave the control on setting HI for toast and for the sealing and fast cooking of foods. For thicker foods requiring longer cooking turn the control to a lower setting after the initial sealing, on both sides, on setting HI. The thicker the food the lower the control should be set.

Warning: Take care as oven/grill will be hot – always wear oven gloves. Always ensure that the grill pan is clean BEFORE use. Excess fat build up in the bottom of the pan could cause a fire hazard.



Top Oven – Conventional Cooking

The heat for conventional cooking in the Top Oven is provided by the grill element and the element under the floor of the oven. The operation of the controls is covered on page 6.

Detailed charts covering suggested temperatures and shelf positions for cooking are given on pages 14 and 15.

These charts are a guide only, giving approximate cooking temperatures and times. To suit personal taste and requirements, it may be necessary to increase or decrease temperatures by 10°C. **Most foods are cooked at a lower temperature in the smaller top oven than in a larger conventional main oven.**

The Top Oven can be used either independently to cook small quantities of food or in conjunction with the Main Oven to provide additional cooking space. To use the oven proceed as follows:

- There are two cooking positions – the shelf placed directly on the floor of the oven, or runner 1 from the floor of the oven. To correctly position the rod shelf the side rods with 'indents' must be uppermost and to the rear, this forms an arrest position in conjunction with the embossed side liners.
- Set the Top Oven control to the required temperature and wait for the thermostat light to go off indicating that the oven has reached the right temperature.
- **Do not place food or dishes on the floor of the oven.**

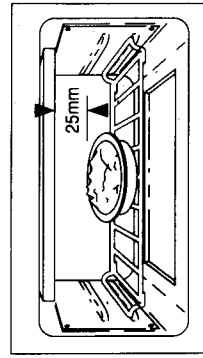
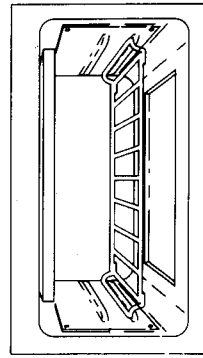

Cooking Meat/Poultry in the Top Oven
The Top Oven is most useful for the longer, slower cooking required for cheaper cuts of meat – casserole cooking, pot roasting, braising, etc.

Small joints of meat up to 1.5kg (3lb) or poultry up to 2.5kg (6lb) in weight can be roasted in a small meat pan in the Top Oven, but should preferably be 'slow roasted' or covered with a lid of aluminium foil (one or two incisions in the top of the foil will allow the meat or poultry to brown). Always ensure that there is at least 25mm (1in) between the top of the foil and the grill element. **Do not** use the meat pan supplied for the main oven or the grill pan for roasting in the Top Oven. Larger joints of meat, weighing more than 1.5kg (3lbs) or poultry weighing more than 2.5kg (6lbs) should be roasted in the main oven.

Platwarming in the Top Oven

Plates and dishes placed on the floor of the Top Oven will be heated when the Main Oven is in use. When the Main Oven is not in use (for instance when a meal is being cooked on the hob) place the plates and serving dishes on the shelf positioned on the lower runner, and turn the Top Oven control to approximately 100°C. A maximum time of 10-12 minutes is all that is required to heat the plates and dishes. **Do not** allow the dishes to come in direct contact with the grill element.

Do not operate the grill control when using the Top Oven for cooking or for warming plates and dishes.

Do take care when removing utensils from the top oven when the main oven is in use as they may become extremely hot.

WARNING: DO NOT PUT DELICATE CHINA OR ITEMS WHICH COULD BE AFFECTED BY HEAT INTO THE OVEN.

Free Manuals Download Website

<http://myh66.com>

<http://usermanuals.us>

<http://www.somanuals.com>

<http://www.4manuals.cc>

<http://www.manual-lib.com>

<http://www.404manual.com>

<http://www.luxmanual.com>

<http://aubethermostatmanual.com>

Golf course search by state

<http://golfingnear.com>

Email search by domain

<http://emailbydomain.com>

Auto manuals search

<http://auto.somanuals.com>

TV manuals search

<http://tv.somanuals.com>