

Hotpoint Service and Spares

FOR SERVICE: If you have a problem with your appliance ring our Nationalcall Service

0541 500 500

You will automatically be connected to your nearest local Service Office.

- 364 days a year service call booking • Same day/next day service
- Repairs fully guaranteed for 12 months
- Five year parts guarantee from purchase date

FOR GENERAL ENQUIRIES:- Each Service Office has a Help Desk to answer general or technical enquiries about your appliance. Simply ring the Nationalcall Number (above) and ask for the Help Desk.

FOR SPARES AND ACCESSORIES: Contact your Spares Centre for prices and availability. Telephone numbers for spares enquiries, for the various regions, are listed below.

Service Offices are open between 8.00am-8.00pm Monday to Friday, 8.00am-6.00pm on Saturdays and 10.00am-4.00pm Sundays.
Spares Centres and Help Desks are open between 8.00am-5.00pm Monday-Friday and 8.00am-12.30pm on Saturdays.

■ Service Office and Spares Centre
● Service Office only

LONDON

Unit 10, Crystal Way, Harrow, Middx. HA1 2HP
For Spares Enquiries (0181) 863 4113

MIDLANDS/NORTH WALES

Westgate, Alcester, W Midlands. WS0 8UX
For Spares Enquiries (01922) 743777
■ NOTTINGHAM:
Ashling Street, Nottingham. NG2 3JB
For Spares Enquiries (0115) 9860387

NORTH

Sandbeck Lane, Wetherby. LS2 4TW
For Spares Enquiries (01937) 581221
■ MANCHESTER:
44/46 Station Rd, Heston Maney, Stockport. SK4 3QT
For Spares Enquiries (0161) 432 0255

SCOTLAND

West Lodge Rd, Blythwood Est, Renfrew. PA4 9EN
For Spares Enquiries (0141) 886 5611

SOUTH

Larfield Trading Estate, New Hythe Lane,
Larfield. ME20 6SW
For Spares Enquiries (01622) 716631

■ SOUTHAMPTON

Unit B, Sth Hampshire Ind. Park, Salisbury Rd,
Totton. SO40 3SA
For Spares Enquiries (01703) 967633

■ SOUTH WALES/SOUTH WEST

18 Western Avenue, Bridgend Ind. Estate,
Bridgend. CF31 3SL
For Spares Enquiries (01656) 796111

EAST

● PETERBOROUGH: Celta Road, Peterborough. PE2 9JB
● CHELMSFORD: Industrial Buildings, Beehive Lane, Chelmsford. CM2 9TE
Note: Neither of the above two offices have Spares Counters. For spares enquiries please ring Central Spares Administration (01733) 556520 - Telephone sales only.

IRELAND

● NORTHERN: 256 Ormeau Road Belfast. BT7 2FZ. Tel: (01232) 647111
● EIRE: 49 Always Ind. Estate, Dublin17
For Spares (00 353 1 842 6088)
For spares (00 353 1 842 6836/6861)

In accordance with its policy of progressive product design, the Company reserves the right to alter specifications. Hotpoint Ltd, Peterborough, PE2 9JB, England

PRINTED BY SIMLEX - FOUR ASHES, WOLVERHAMPTON.

May 1996 Part No. 423300033

INSTALLATION INSTRUCTIONS AND OPERATING INSTRUCTIONS GAS HOB MODEL BG51 B/P

Hotpoint®

AGENTS	
CHANNEL ISLANDS. - Service provided by Agents. Normal Guarantees apply and certain Extended Warranty Schemes are available. Reg Mauger Services Ltd 19 Don Street, St Helier. Tel: (01534) 21625 Quick Fix Services L'esperze, Rue de la Croix St. Clements. Tel: (01534) 854808	GUERNSEY & SARK: Colin Tonole Ltd, Grande Rue, St. Martins, Guernsey. Tel: (01481) 39422 Lakura Appliances Service Ltd Barra Lane, Vale Tel: (01481) 51610 D.A. Walters, 32 High Street Tel: (01481) 822686
ALDERNEY:	
ISLE OF MAN. - Service provided by Agents. Normal Guarantees apply and certain Extended Warranty Schemes are available. From Partingtons 64 Duke St, Douglas Tel: (01624) 673233 R. Pascoe, Trossachs Works Cromwell Road, Village, Douglas Tel: (01624) 678366 Manx Electricity Authority PO Box 177 Victoria Rd St. Douglas Tel: (01624) 625811	
SHETLAND, ORKNEY AND WESTERN ISLES Service provided by Agents. Normal Guarantees apply, but Service Schemes are not available. SHETLAND: Robertson & Peterson Fort Road, Lerwick Tel: (01595) 692557 Orkneys: Hastings Ind. Estate, Kirkwall Tel: (01850) 875457 Western Isles: N B McLeod Church Street Stormoray, Isle of Lewis Tel: (01851) 705555 Which are covered by Hotpoint BUTE AND SKYE.	

Contents

Installation Instructions	4
General Requirements	4
Documents Related To Installation Work	4
Ventilation	4
Gas Supply Requirements	4
Electricity Supply Requirements For The Igniters	4
Installation	6
General	6
Dimensional Requirements	6
Procedure	7
Commissioning and testing the installation	8
Operating Instructions	9
Operation	9
To Light The Burner	9
Control Knobs	9
Cooking	10
Drop Down Glass Lid	11
Safety Recommendations	11
Cleaning & Caring For Your Hob	12
Enamelled Parts, The Control Panel and Lid	12
Gas Burners	12
General Care and Maintenance	13
If Your Hob Won't Work	13
Spare Parts	14
Hotpoint Service Cover	15
Hotpoint Service Offices & Spares Centre	Back Page

Hotpoint Service Cover

Satisfaction Guaranteed or Your Money Back

Hotpoint gives you a unique 'Satisfaction Guaranteed' promise – valid for ninety days after you have purchased your Hotpoint product. If there is a technical problem with your Hotpoint appliance, just call Hotpoint Service (see back page). If necessary we will arrange for an engineer to call. If the technical problem is not resolved under this Guarantee, Hotpoint will replace your appliance or, if you prefer, give you your money back. Your statutory rights are not affected, and the Guarantee is additional and subject to the terms of Hotpoint's Five Year Parts Guarantee.

Hotpoint's Free Five Year Guarantee

From the moment your appliance is delivered Hotpoint guarantees it for **FIVE YEARS**.

- In the Five Years all replacement parts are **FREE** provided that they are fitted by our own Service Engineer. During the first year our Engineer's time and labour is also free.
- Our guarantee covers loss of food in our refrigeration and freezer products up to £250 during the first year, subject to verification by one of our engineers.
- After the first year we will charge for our Engineer's time and labour. We do, however, operate a range of Service Plans (see opposite) which, for an annual payment, enables you to cover any repair costs which may be necessary.
- All our service repairs are guaranteed for twelve months in respect of our labour and any parts fitted.
- The appliance must be used in the United Kingdom, and must not be tampered with or taken apart by anyone other than our own Service Engineers.
- You may, however, buy parts which can be safely fitted without specialist knowledge or equipment. The correct fitting of such parts, provided they are genuine Hotpoint spares, will not affect your Guarantee. Parts are available from our Hotpoint Spares Centres (see back page).
- Our guarantee does not cover the cost of any repair, or loss of food in refrigeration products, due to power failure, accidents or misuse. Nor does it cover the cost of any visits to advise you on the use of your appliance. Please read thoroughly the instruction book supplied with this appliance.
- If at any time during the Guarantee period we are unable to repair your appliance, we will refund any repair costs paid to us in the previous twelve months. We will also offer you a new appliance at a reduced charge instead of a repair.
- Our Guarantee is in addition to and does not affect your legal rights.
- Should you need independent advice on your consumer rights, help is available from your Consumer Advice Centre, Law Centre, Trading Standards Department and Citizens Advice Bureau.
- All Hotpoint servicing is carried out by our own Service Organisation located throughout the United Kingdom and Eire. We will be happy to deal with any problems which you may have.

Hotpoint's Extended Warranties

Whether you have just one or a number of Hotpoint appliances in your kitchen, Hotpoint has a range of Service Plans to give you complete peace of mind. They enable you to extend your one year labour guarantee so that you can have repairs completed **FREE** during the membership period.

Service Cover

We offer a number of payment methods; cheque, credit card or you can spread the cost and pay by direct debit (full details can be obtained on Free phone 0800 710356). This covers you for all repairs during the period of cover, which can be from 1 to 4 years. Service Cover also includes loss of food, up to the value of £250, in refrigeration appliances. There is also an option of Service Cover with Maintenance at an additional cost. This includes an annual Electrical and Safety check and replacement of any parts as necessary.

Kitchen Cover

An annual payment covers you for all repairs for all your Hotpoint appliances which are less than ten years old. It also covers the cost of loss of food up to £250 in our refrigeration and freezer products. There is also the option of Kitchen Cover with Maintenance at an additional cost. Any additional Hotpoint appliances purchased after you have joined Hotpoint Kitchen Cover will automatically be included during the annual period of cover without further charge.

Appliance Registration

To ensure that you have the opportunity to benefit from any of the above Service Schemes and other offers you should complete and return immediately the Appliance Registration Form/Questionnaire supplied with this appliance. Full details and costs of our Service Schemes, together with an application form, will be sent to you at the end of the first year of the guarantee.

Annual Safety/Maintenance Checks

Hotpoint strongly recommends that all its appliances are regularly checked for electrical and mechanical safety, whether or not they are covered by a Service Plan. Worn door gaskets or hoses may cause a leak on an appliance, which could become dangerous if neglected.

Proof of Purchase

For future reference please attach your purchase receipt to this booklet and keep it in a safe place.

Spares and Accessories

Spares and accessories can be ordered from your local Hotpoint Spares Centre (see back page), using the order form enclosed.

NOTE: Our Engineers will use every effort to avoid damage to floor coverings and adjacent units when carrying out repairs/service work, but in locations where the Engineer advises you that it will be impossible to move appliances without risk of damage, he will only proceed with your approval that no liability is accepted.

Spare Parts

Please remember your new appliance is a complex piece of equipment. 'DIY' repairs or unqualified and untrained service people may put you in danger, could damage the appliance and might mean you lose cover under Hotpoint's Parts Guarantee.

If you do experience a problem with the appliance don't take risks; call in Hotpoint's own Service Engineer. The address and telephone number of your nearest Hotpoint Service Office is in your local telephone directory. Our spare parts are designed exclusively to fit only Hotpoint appliances. Do not use them for any other purpose as you may create a safety hazard.



This appliance conforms to the following EEC Directives:

Gas Appliances
90/396/EEC
93/68/EEC

Low Voltage Equipment
73/23/EEC
93/68/EEC

Electromagnetic Compatibility
89/336/EEC
92/31/EEC
93/68/EEC

THIS APPLIANCE MUST BE INSTALLED IN ACCORDANCE WITH THE RULES IN FORCE, AND USED ONLY IN A SUFFICIENTLY VENTILATED SPACE. CONSULT INSTRUCTIONS BEFORE INSTALLATION AND USE OF THIS APPLIANCE.

Your new appliance

Model BG51B
Model BG51P

This handbook gives full instructions for installing and operating your new Hotpoint Hob.

Please read these instructions carefully **before** using the hob for the first time.

Make sure that any electrical wiring is carried out by a qualified electrician and any gas connections are made by an authorised gas fitter.

This appliance has been adjusted for use with natural gas and cannot be used on any other gas.

WARNING: CHILDREN SHOULD NOT BE ALLOWED TO PLAY WITH THE APPLIANCE OR TAMPER WITH THE CONTROLS.

Please read right through these instructions **before** commencing any installation work.

On opening the package the contents should be:

- One Mink Brown (Model BG51B) or Polar White (Model BG51P) Hob, complete with matching toughened glass lid.
- One basebox.
- Four burner caps.
- Fitting screws.
- Sealing compound.

Retention of this Instruction Book

This Instruction Book must be kept handy for reference as it contains important details on the safe and proper use of the appliance. If you sell or pass the appliance to someone else, or move house and leave it behind, make sure this Book is also provided so the new owner can become familiar with the appliance and safety warnings.

If the Book is lost or damaged a copy may be obtained from Hotpoint Ltd, Celta Road, Peterborough, PE2 9JB.

General requirements

Documents related to installation work

This handbook gives details for installing the Hotpoint BG51B and BG51P gas hobs. Due reference must be made to the following:

1. These appliances must be installed and serviced by competent persons in accordance with the Gas Safety Installations and Users Regulations 1984 and relevant Codes of Practice. Failure to comply with these or any other regulations in force could lead to prosecution.
2. When installing these appliances due account must be taken of relevant British Standards and Codes of Practice; BS6172: 1990, BS5440: Part 2: 1989, BS6891: 1988, Building Regulations, Building Standards (Scotland) (Consolidation) Regulations, Appropriate IEE and Electricity Company Regulations

Incorrect installation could affect the safety of the appliance

Ventilation

The appliance should not be fitted in a room of less than 6m³ volume. All rooms require an opening window while some rooms require a permanent vent in addition. The hob should not be fitted in a bed-sitting room of less than 21m³ volume. Rooms of 6m³ to 9m³ must have a vent of 65cm² free area. Rooms of 9m³ to 11m³ require a vent of 35cm² free area and rooms exceeding 11m³ in volume do not need to have a vent. If a room has a door which opens directly to the outside air, not vent is required.

It is essential that no water or detergent is allowed to remain in the Flame Ports. Also make sure that cleaning materials, water or dirt do not enter the burner body when the burner cap is removed.

The enamelled disc is removable for easy cleaning. Use a fine steel wool soap pad to remove stubborn stains. When refitting put the cap centrally onto the body and turn it until it drops into position.

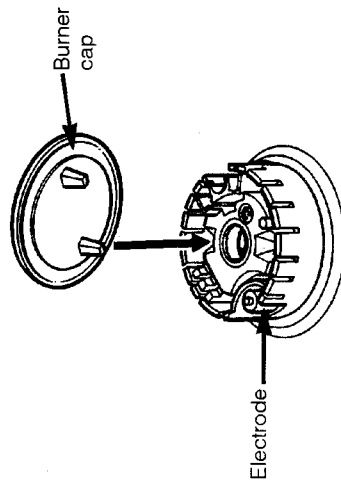

If your hob won't work . . . don't panic

Just run through these quick checks before calling your local Hotpoint Service Office.

1. Have you replaced the lid after cleaning? – see page 7.
 2. If the ignition system does not work check that the mains gas and electricity supply are switched on.
 3. If the flame is irregular check that the burner cap is correctly positioned – see Fig. 4 – and that the flame ports are clear. See notes about cleaning on page 7.
- If, after following these instructions, you are still having problems, contact your nearest Hotpoint Service Office. The telephone number is shown on the back page.

When you contact us we need to know:

1. Your name, address and post code.
 2. Your telephone number.
 3. Clear and concise details of the fault.
 4. The Model number (BG51B or BG51P)
 5. When it was purchased.
- Please put the purchase date here
-

General care and maintenance
If any leakage is seen between hob and worktop a service engineer should be called.

It is essential to keep all burners clean from cooking overspill. If you are not satisfied that your hob is working correctly, do not tamper with the controls but contact your local Hotpoint Service Office for expert assistance. (See back page for the nearest.)

Make sure you have all these details before you call and meanwhile switch off the appliance and leave it alone until the engineer calls.

Energy Saving Hints

Save it tips

In order to get the best value out of your gas hob, the following **ECONOMY TIPS** are recommended. Choose the correct flame for the size of pan. Place pans centrally over the burner. Always use saucepans with lids. Turn down the gas as soon as the contents of the pan have boiled. Only fill kettles or pans with the minimum amount of liquid needed. **Do not** light the burner until the pan is in position and turn off the burner before removing the pan. Cut vegetables into smaller pieces as they cook faster. Cook more than one vegetable in the same pan e.g. carrots and potatoes. Descale kettles regularly. Consider using a pressure cooker.

Cleaning/Caring for your Hob

IMPORTANT: Switch off electrical supply to the hob and ensure it is cold before cleaning.

Enamelled parts, the Control Panel and Lid

The Lid, Control Knobs, Control Panel and Pan Supports can all be removed for easy cleaning.

The Lid:

Simply lift clear of the hinges and clean using a soapy cloth over the sink. **Do not** immerse in the water. Replace so that the hinges on both sides fit into the slots at the back.

The Control Knobs and Panel: The Knobs (including the ignition button) can be removed by simply pulling them off. This then allows the Control Panel to be lifted clear. The Knobs and Control Panel can be immersed in hot soapy water to clean.

The Pan Supports:

Lift off and clean in hot soapy water. They can also be washed in a dishwasher. Use a fine steel wool soap pad to remove stubborn stains. When replacing the pan supports position them with the short fingers in the centre (see Fig. 3). These extra fingers allow the easy movement of pans between burners.

Gas Burners

It is important that the Flame Ports, and Gas Hole are kept clean.

If a Flame Port becomes blocked, clean as follows:

A pin or cocktail stick can be used to remove stubborn blockages from Flame Ports and the Air and Gas Holes in the burner body.

General requirements (cont)

Any permanent electrical installation should be carried out in compliance with the appropriate IEE and local Electricity Company regulations by a qualified electrician e.g. your local Electricity Company or a contractor who is on the roll of the National Inspection Council for Electrical Installation (NICEIC).

WARNING INCORRECT INSTALLATION COULD AFFECT THE SAFETY OF THE APPLIANCE.

If the hob is permanently wired in, this must be via a suitable double pole isolating switch placed in a readily accessible position adjacent to the hob.

WARNING: THIS APPLIANCE MUST BE EARTHED.

IMPORTANT: Fitting a different plug:

The wires in this mains lead are coloured in accordance with the following code:

Green and Yellow – Earth
Blue – Neutral
Brown – Live

If you fit your own plug, the colours of these wires may not correspond with the identifying marks on the plug terminals. This is what you have to do:

1. Connect the green and yellow (Earth) wire to the terminal in the plug marked 'E' or with the symbol , or coloured green or green and yellow.
2. Connect the blue (Neutral) wire to the terminal in the plug marked 'N' or coloured black.
3. Connect the brown (Live) wire to the terminal marked 'L' or coloured red.

With alternative plugs a 5A fuse must be fitted either in the plug or adaptor or in the main fuse box. In the event of replacing a fuse in the plug supplied, a 3A ASTA approved fuse to BS1362 must be fitted. If the plug is the moulded on type the fuse cover must be refitted when changing the fuse. In the event of losing the fuse cover, the plug must **NOT** be used until a replacement fuse cover has been obtained and fitted. A new fuse cover can be obtained from your nearest Hotpoint Service Office or local Electricity Company. The colour of the correct replacement fuse cover is that of the coloured marks or insert in the base of the plug.

Installation

General

WARNING

Before connecting or installing the hob, the electricity and gas supplies must be turned OFF.

WHEN INSTALLING THE APPLIANCE TAKE CARE TO AVOID ANY SHARP EDGES.

Weight of the hob: 12.6kg.

The edge of the hob must be a minimum of 30mm away from a tall unit or wall, and we recommend that you do not put it at the very end of the work surface as this could cause difficulty in fixing down the work surface. If a shelf, cupboard or hood is fitted above the hob the minimum distance must be 785mm. A drawer can be installed below providing there is a minimum depth of 75mm below the worktop cutout (see Fig. 2 page 6).

Dimensional requirements

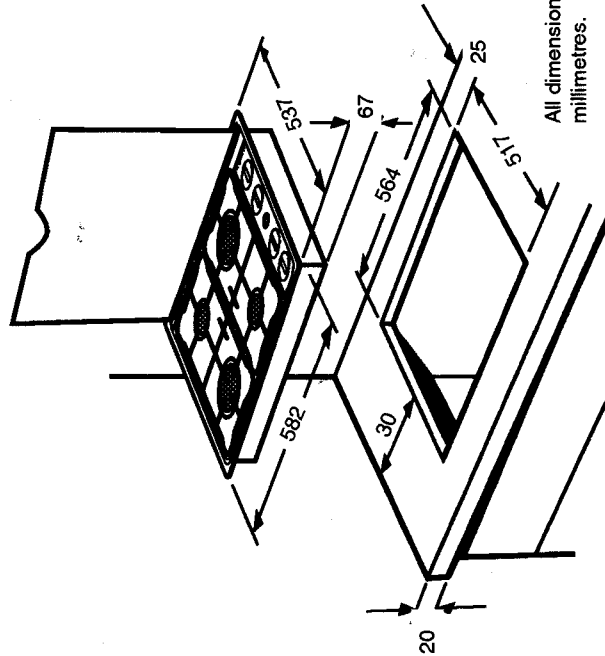

Fig. 1

NOTE: Installation above an oven
If installed above a built-under oven then the oven will need to be lowered from its normal position as follows:

- With 30mm worktop lower the oven by 25mm
- With 40mm worktop lower the oven by 15mm

IMPORTANT
The hob and unit in which it is installed must be both stable and level

DON'T:- Use the gas hob to heat the kitchen.

DON'T:- Use the glass surface for chopping and cutting as this will damage the smooth surface.

If you should smell gas, turn off all gas appliances, open windows for good ventilation and telephone your local gas supplier or gas board for assistance. **DO NOT USE A NAKED LIGHT.**

Safety Recommendations for Deep Fat Frying

The following recommendations should be followed:

- Never leave the pan unattended on the heat, e.g. to answer the telephone.
- Use a deep pan large enough to cover the cooking zone.
- Never fill the pan more than one third full with oil or fat. On no account mix oil and fat.
- Do not overload the pan by trying to fry too much. The pan containing oil and food should not be more than two thirds full.
- Dry food thoroughly before frying and lower it slowly into the oil.
- Do not use a lid on the pan.
- Keep the outside of the pan clean and free from fat and oil.
- Do not allow excessive splashing of oil onto the hob.

Drop down glass lid

The drop down lid on your hob is made from toughened glass and gives a useful extra worktop when folded down. It can be removed for easy cleaning but the hob will not operate until it is replaced.

To prevent damage to the lid and to ensure safety in use please follow these simple rules:-

- Do not use the lid for chopping or slicing of foods.
 - Make sure that the lid is fully raised before turning on the gas.
 - Make sure that pans are not in contact with the lid when they are being heated.
 - Do not place hot objects, such as pots and pans, on the lid.
 - The lid is designed with a special cut-out to prevent it being lowered on a lighted burner.
- However you must turn the gas off when the lid is raised as the burner will not re-ignite.**

Utensils

Any type of flat based kettle or pan from 100mm (4in) to 230mm (9in) base diameter may be used. Do not use pans which are unstable when placed on a flat worktop. The use of split pans, i.e. those comprising two or more pans designed to fit together over a single burner, is not recommended as these can be unstable on the hotplate. Heat resistant mats should not be used on the pan supports because they may impede burner performance or damage the pan support.

Operating Instructions (cont)

Cooking

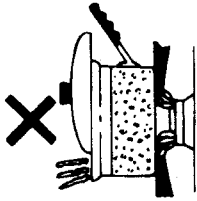
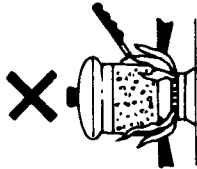
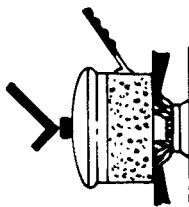

How to use the Gas Hob

DO bring items to the boil on the large flame setting, then turn to the small flame setting for simmering. For maximum efficiency the flame should always remain underneath the pan and in order to save time and money always try to cook in a pan with a lid on.

DON'T use an asbestos mat or anything else between the pan and the gas burner to spread the heat as this will damage the burners. **DON'T** use pans that are unstable on a flat work top.

NEVER use split pans, i.e. those comprising two or more pans designed to fit together and placed/used over a single burner – as they can be unstable.

Safety

Some **DO's** and **DON'T's** for safety's sake

DO:- Keep the outside of pans free from fat and oil.

DO:- Dry all food prior to frying and lower slowly into hot fat or oil to avoid spitting and frothing.

DO:- Use lids on saucepans whenever possible.

DO:- Turn down the gas as soon as the pan contents boil.

DO:- Turn off the gas before removing a pan.

DO:- Use a food thermometer and ensure fat or oil does not exceed 190°C.

DON'T:- Fill a pan more than one third full of fat or oil.

DON'T:- Leave a pan of fat or oil unattended on a lighted burner.

DON'T:- Light gas until a pan is in position.

DON'T:- Allow burner flames to overspill the base of the pan.

DON'T:- Use a pan which is not completely stable on the pan support.

DON'T:- Overfill pans or kettles.

DON'T:- Leave pan handles in a position where they can be reached by children, easily knocked or burnt by another burner.

DON'T:- Use pans which have damaged handles.

DON'T:- Allow larger size pans to overhang pan supports.

DON'T:- Press the ignition button when any of the burner caps are removed as this may reduce the life of the spark generator.

Installation (cont)

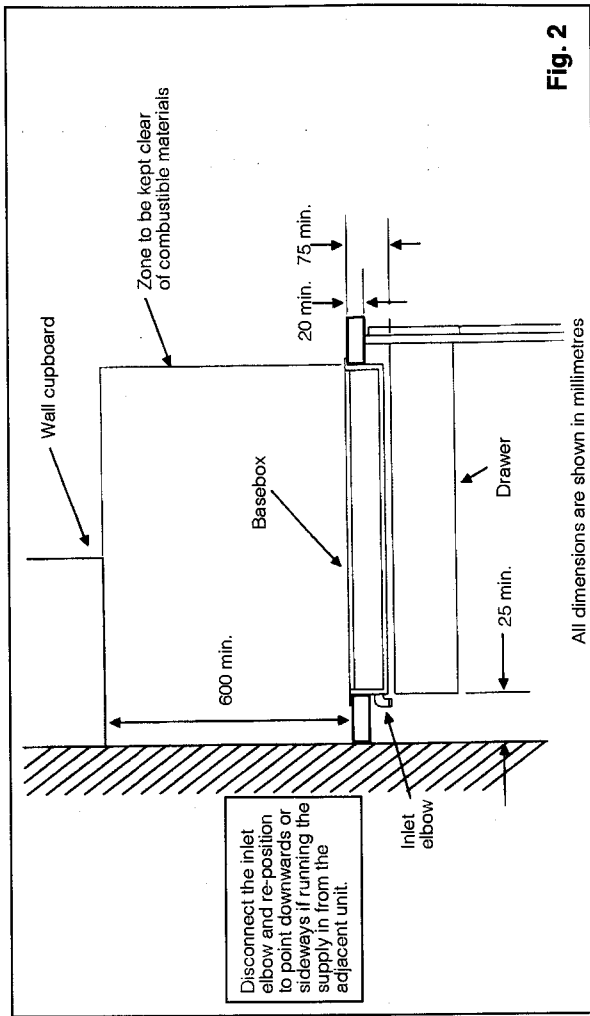

Fig. 2

TO FIT BASEBOX TO WORKTOP

After unpacking, raise the glass lid and lift clear from supports. Remove burner caps and pan supports. Pull off the control knobs, ignition button and fascia panel and then undo the two fixing screws revealed. Also remove the screw at the centre of the underside of the basebox.

Raise hob units right hand side and slide it to the right and away from the basebox.

Disconnect the inlet elbow and re-position to point downwards (see Fig. 2), or sideways if running the gas supply in from the adjacent unit.

Fit sealing tape around the worktop cutout. Lower basebox in with the gas connection to the rear and ensuring that the mains lead is not trapped. Press down around the edges to seal. Secure basebox to the worktop with the four screws provided.

TO CONNECT TO THE GAS SUPPLY

The gas inlet must conform to BS21. The hob may be connected by means of a flexible connection to BS669. The temperature rise on the appliance likely to come into contact with the hose do not exceed 70°.

When fitting above a Built in Oven, a rigid or semi rigid connection must be used. The burner aeration is pre-set and requires no further adjustment. Check for gas soundness.

Test the gas pressure at any injector using the pressure test adaptor provided in place of one of the injectors. Once the pressure has been tested re-fit the original injector.

Note: During this test the cut-off valve will have to be manually operated by pulling the valve operating lever forward.

TO FIT THE HOB ASSEMBLY

Lower the left hand side of the hob into the basebox and slide to the left, so engaging the hob onto the bracket on the basebox. Lower the hob into the basebox and refit the three fixing screws.

Replace the fascia panel, control knobs, ignition button, burner caps and pan supports.

Refit the glass lid into the supports at the rear.

Commissioning and testing the installation

Notes

- The burners will not light unless the electricity supply is switched on.
 - The glass lid must be fully closed and then re-opened to engage the gas operating lever and open the gas valve.
- Purge all air from the pipework before igniting. **ALWAYS** carry out leak test on installation after completion using leak detection fluid.
- To light the gas, press in and turn the control knob anti-clockwise to the full on position shown by the large flame symbol . Then press the ignition button to produce a stream of sparks. The burner should light within three seconds.

Flow rate check

Check the total hourly flow rate with all burners full on using the meter dial and stop watch in the usual way. Check the rate of each burner separately. Ensure that all other gas appliances are switched off during the test.

Total flow rate	8.80kW	(30,000 Btu/hr)
Rapid burners (RHR & LHF)	2.75kW each	(9,400 Btu/hr)
Semi-Rapid burners (LHR & RHF)	1.65kW	(5,800 Btu/hr)

What to do in the event of problems

If you have any difficulty with the installation of this appliance please contact the nearest Hotpoint Service Office (see back page) which will be able to give you advice.

When the appliance is installed

Make sure that the Hotpoint appliance user instructions on the correct use and care of the appliance are available. If the appliance is fitted by someone who is not the user, then ensure that the user retains these and the user instructions and understands how to operate the appliance.

Operating Instructions

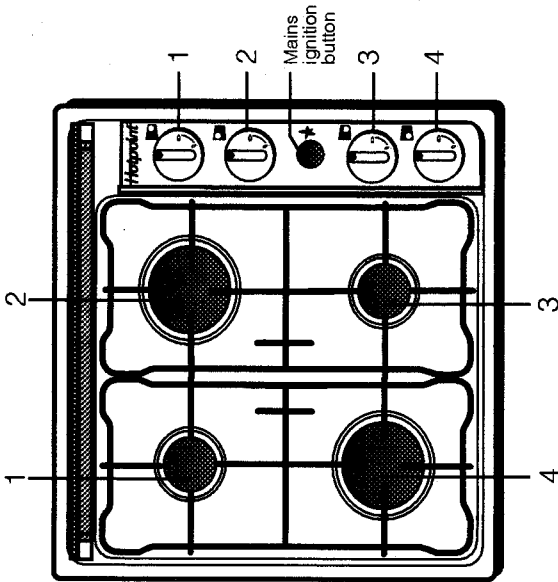

- Heating areas:
- 1.65kW 5600 Btu/h
 - 2.75kW 9400 Btu/h
 - 1.65kW 5600 Btu/h
 - 2.75kW 9400 Btu/h

Electronic mains ignition 240V ac.



To light the burner

First ensure that the gas and electricity supplies are switched on. (The ignition spark will not operate unless the electric supply is on.) Press in and turn the appropriate burner control anti-clockwise to the full on position, denoted by the large flame symbol  see Fig. 4.

Then press the ignition button  to produce a stream of sparks at each burner which lights the gas. If the burner does not light within three seconds then turn the control knob to the off position, denoted by the  symbol – see Fig. 4 – and repeat the process.

WARNING: The hob top assembly can become hot during use. The base will also get quite hot, so care should be taken when using any drawer over which it is fitted.

Control knobs





The control knobs are marked with three symbols, i.e. Off = , Full on = , Minimum = .

Fig. 4

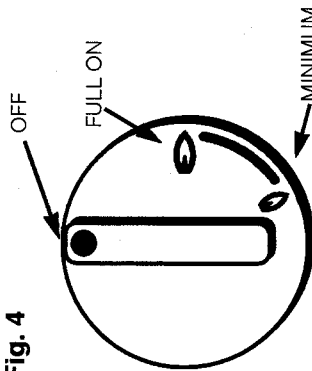

To select any of these turn the knob until the symbol lines up with the line on the control panel.

The flame setting is fully variable between the Full  and Minimum  settings to give control from a fast boil to a gentle simmer.

The front left and rear right burners have a large and extra powerful 2.75kW rating and the other burners are rated at 1.65kW.

Free Manuals Download Website

<http://myh66.com>

<http://usermanuals.us>

<http://www.somanuals.com>

<http://www.4manuals.cc>

<http://www.manual-lib.com>

<http://www.404manual.com>

<http://www.luxmanual.com>

<http://aubethermostatmanual.com>

Golf course search by state

<http://golfingnear.com>

Email search by domain

<http://emailbydomain.com>

Auto manuals search

<http://auto.somanuals.com>

TV manuals search

<http://tv.somanuals.com>