

Instructions for Installation and Use

50cm Free Standing Gas Cooker

CH50GCIK
CH50GCIW
CH50GCIS

To the Installer

Before installation fill in the product details on the back cover this book.
The information can be found on the rating plate.

To the User

You must read the instructions prior to installing and using the appliance and
then retain them for future reference.



Please phone us on
08448 24 24 24
to activate your
guarantee

PLEASE PHONE US TO REGISTER YOUR APPLIANCE AND ACTIVATE YOUR PARTS GUARANTEE ON 08448 24 24 24

Contents

Introduction	3
Installation	4
Electrical connection	6
Burner and Nozzle Specifications	7
Safety Information	8
Features	10
Control Panel	11
Use of hotplates	12
Use of Grill	13
Use of Main Oven	14
Oven cooking charts	15
Using the Main Oven for Other Functions	16
Care and Cleaning	17
Cooking Results Not Satisfactory?	18
Something Wrong With Your Cooker?	19
Technical Characteristics	20
Electronic timer	21
Key Contacts	Back Cover

You must read these instructions prior to using your appliance and retain them for future use.

Introduction

Your new appliance is guaranteed* and will give lasting service. This guarantee is only applicable if the appliance has been installed in accordance with the installation instructions detailed in this booklet.

To help make best use of your cooking equipment, please read this booklet carefully.

The cooker is designed specifically for domestic use and responsibility will not be accepted for use in any other installation.

When the cooker is first used an odour may be emitted, this will cease after a period of use.

When first using the cooker ensure that the room is well ventilated (e.g. open a window or use an extractor fan) and that persons who may be sensitive to the odour avoid any fumes. It is suggested that any pets be removed from the room until the smell has ceased. This odour is due to temporary finish on oven liners and elements and also any moisture absorbed by the insulation.

*** The guarantee is subject to the provisions that the appliance:**

- (a) Has been used solely in accordance with the Users Instruction Book.**
- (b) Has been properly connected to a suitable supply voltage as stated on the rating plate attached to this equipment.**
- (c) Has not been subjected to misuse or accident or been modified or repaired by any person other than the authorised employee or agent.**
- (d) Has been correctly installed.**

- 1 This appliance is intended for nonprofessional use within the home.
- 2 These instructions are only for those countries whose symbols appear in the booklet and on the serial no. plate of the appliance.
- 3 **This owner's manual is for a class 1 appliance (insulated) or class 2, subclass 1 appliances (installed between two cabinets).**

Keep the appliance clean, as a build up of grease or fat from cooking can cause a fire.

Installation

The appliance must only be installed by a competent person. In the UK, Gas Safe registered installers undertake to work to safe and satisfactory standards.

Before moving your cooker check that it is cool, and switch off at the cooker control unit. Movement of your cooker is most easily achieved by lifting the front as follows:

Open the grill door sufficiently to allow a comfortable grip on the underside front edge of the oven roof, avoiding any grill elements.

Note: Take care in moving the cooker as it is heavy. Take care to ensure that any floor covering is not damaged. (FIG. C)

Splashplate optional, apply to Parts Department (see Back Cover for contact number.)

The following instructions should be read by a qualified technician to ensure that the appliance is installed, regulated and technically serviced correctly in compliance with current regulations.

Important: remember to unplug the appliance from the mains before regulating the appliance or carrying out any maintenance work.

Positioning

Important: this unit may be installed and used only in permanently ventilated rooms according to the British Standards Codes Of Practice: B.S. 6172/B.S. 5440, Par. 2 and B.S. 6891 Current Editions. The following requirements must be observed:

- The cooker should not be installed in a bed sitting room with a volume of less than 20m³. If it is installed in a room of volume less than 5m³ an air vent of effective area of 110cm² is required, if it is installed in a room of volume between 5m³ and 10m³ a supplementary airvent area of 50cm² is required, if the volume exceeds 11m³ no airvent is required. However, if the room has a door or a window which opens directly to the outside no air vent is required even when the volume is between 5m³ and 11m³.
- During prolonged use of the appliance you may consider it necessary to open a window to the outside to improve ventilation.
- If there are other fuel burning appliances in the same room, B.S.5440 Part 2 Current Edition, should, be consulted to determine the requisite air vent requirements.

Installation of the cooker

For a correct installation of the cooker the following precautions must be followed:

The height of the cooker can be adjusted by means of adjustable feet in the plinth (900mm - 930mm). Adjust the feet by tilting the cooker from the side. Then install the product into position.

NOTE: This appliance must not be fitted on a platform.

The cooker is designed to fit between kitchen cabinets spaced 500mm apart. The space either side need only be sufficient to allow withdrawal of the cooker for servicing. It can be used with cabinets one side or both as well as in a corner setting. It can also be used free-standing.

Adjacent side walls which project above hob level, must not be nearer to the cooker than 150mm or 65mm (Fig. A) and should be protected by heat resistant material. Any overhanging surface or cooker hood should not be nearer than 750mm. (Fig.A)

- The cooker may be located in a kitchen, a kitchen/diner or bed sitting room, but not in a bathroom or shower room.
- The hoods must be installed according to the requirements in the hood handbook.
- The wall in contact with the back of the cooker must be of flameproof material.
- The cooker is fitted with a safety chain that must be attached to a hook, secured to the wall behind the appliance.

Note: some models can have their gas connection inverted. It is important to make sure the safety chain is always situated on the side which corresponds to the hose holder (Fig. B).

Tall cupboard on the right hand side of 50cm gas cooker

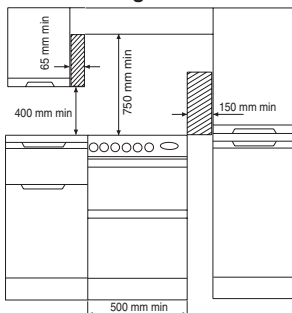

Fig. A

Tall cupboard on the left hand side of 50cm gas cooker

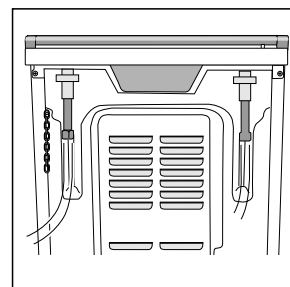
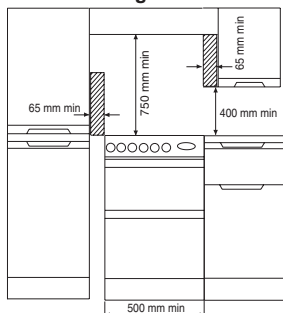

Fig. B

Moving the Cooker

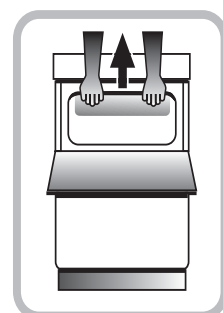
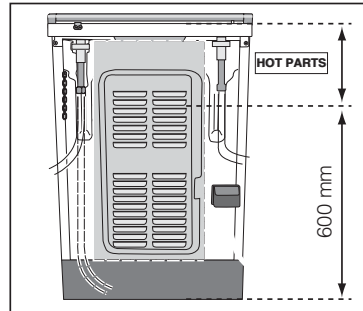

Fig. C

PLEASE PHONE US TO REGISTER YOUR APPLIANCE AND ACTIVATE YOUR PARTS GUARANTEE ON 08448 24 24 24

Gas connection

The cooker should be connected to the gas-supply by a Gas Safe registered installer. During installation of this product it is essential to fit an approved gas tap to isolate the supply from the appliance for the convenience of any subsequent removal or servicing. Connection of the appliance to the gas mains must be carried out according to the prescribed regulation in force, and only after it is ascertained that it is adaptable to the type of gas to be used. On some models the gas supply can be connected on the left or on the right, as necessary; to change the connection, reverse the position of the hose holder with that of the cap and replace the gasket (supplied with the appliance). In the case of connection to liquid gas, by tank, use pressure regulators that conform to the regulation in force. The gas supply must be connected to the left of the appliance. Be sure that the hose does not pass through the rear of the cooker touching hot parts.



Important: make sure the supply pressure conforms with the values shown in the table entitled “Characteristics of the burners and nozzles”. **When the cooker is installed between cabinets (recessed), the gas connection must be effected by an approved flexible hose with bayonet fitting (BS 669 Current Edition). The gas inlet for the cookers is a threaded G 1/2 gas female fitting.**

Connecting the gas supply

To make the connection, a flexible hose should be used corresponding to the current gas regulations which are:

- the hose must never be at any point in its length in contact with the “hot” parts of the cooker;
- the hose must never be longer than 1,5 metre;
- the hose must not be subject to any tension or torsional stress and it must not have any excessively narrow curves or bottlenecks;
- the hose must be easy to inspect along its entire length to check its condition;
- the hose must always be in good condition, never attempt to repair.

Important: the installation must comply with gas safety (installation and use) regulations 1984. In all cases for the above, by law, a qualified, Gas Safe approved engineer must be called for installation.

Disposing of the appliance

When disposing of the appliance please remove the plug by cutting the mains cable as close as possible to the plug body and dispose of it as described above.

- turn the tap to minimum;
- remove the knob and adjust the regulation screw, which is positioned in or next to the tap pin, until the flame is small but steady.
N.B.: in the case of liquid gas, the regulation screw must be screwed in to the bottom.
- check that the flame does not turn off when you turn the tap quickly from high to low.

Electrical connection

Power supply voltage and frequency: 220-240V a.c. 50 Hz.

Note: the supply cable must be positioned so that it never reaches at any point a temperature 50°C higher than the room temperature. The cable must be routed away from the rear vents. Should you require it, you may use a longer cable, however, you must ensure that the cable supplied with the appliance is replaced by one of the same specifications in accordance with current standards and legislation.

Your appliance is supplied with a 13 amp fused plug that can be plugged into a 13 amp socket for immediate use. Before using the appliance please read the instructions below.

WARNING - THIS APPLIANCE MUST BE EARTHED.

THE FOLLOWING OPERATIONS SHOULD BE CARRIED OUT BY A QUALIFIED ELECTRICIAN.

Replacing the fuse:

When replacing a faulty fuse, a 13 amp ASTA approved fuse to BS 1362 should always be used, and the fuse cover re-fitted. If the fuse cover is lost, the plug must not be used until a replacement is obtained.

Replacement fuse covers:

If a replacement fuse cover is fitted, it must be of the correct colour as indicated by the coloured marking or the colour that is embossed in words on the base of the plug. Replacements can be obtained directly from your nearest Service Depot.

Removing the plug:

If your appliance has a non-rewireable moulded plug and you should wish to remove it to add a cable extension or to re-route the mains cable through partitions, units etc., please ensure that either:

- the plug is replaced by a fused 13 amp re-wireable plug bearing the BSI mark of approval.
- or:
- the mains cable is wired directly into a 13 amp cable outlet, controlled by a switch, (in compliance with BS 5733) which is accessible without moving the appliance.

Please note: for appliances with a rating greater than 13 amp (eg: electric hob, double ovens and freestanding electric cookers etc.) the mains cable must be wired into a cooker output point with a rating of 45 amp. In this case the cable is not supplied.

Disposing of the plug:

Ensure that before disposing of the plug itself, you make the pins unusable so that it cannot be accidentally inserted into a socket. Instructions for connecting cable to an alternative plug:

Important: the wires in the mains lead are coloured in accordance with the following code:

Green & Yellow	- Earth
Blue	- Neutral
Brown	- Live

If the colours of the wires in the mains lead do not correspond with the coloured markings identifying the terminals in your plug, proceed as follows:

Connect Green & Yellow wire to terminal marked "E" or  or coloured Green or Green & Yellow.

Connect Brown wire to terminal marked "L" or coloured Red.

Connect Blue wire to terminal marked "N" or coloured Black.

If a 13 amp plug (BS 1363) is used it must be fitted with a 13 amp fuse. A 15 amp plug must be protected by a 15 amp fuse, either in the plug or adaptor or at the distribution board. If you are in any doubt about the electrical supply to your machine, consult a qualified electrician before use.

How to connect an alternative plug:

The wires in this mains lead are coloured in accordance with the following code:

BLUE	"NEUTRAL" ("N")
BROWN	"LIVE" ("L")
GREEN AND YELLOW	"EARTH" ("E")

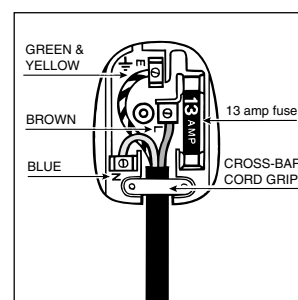

PLEASE PHONE US TO REGISTER YOUR APPLIANCE AND ACTIVATE YOUR PARTS GUARANTEE ON 08448 24 24 24

Burner and Nozzle Specifications

Burner	Diameter (mm)		Thermal Power kW (p.c.s.*) Nominal	Liquid Gas					Natural Gas		
				Thermal Power kW (p.c.s.*) Reduced	By-Pass 1/100 (mm)	Nozzle 1/100 (mm)	Flow* g/h		Thermal Power kW (p.c.s.*) Reduced	Nozzle 1/100 (mm)	Flow* l/h
							***	**			
Fast (Large)(R)	100	94	2,60	0,70	41	80	189	186	0,70	118	248
Semi Fast (Medium)(S)	75	69	1,90	0,40	30	70	138	136	0,40	104	181
Auxiliary (Small)(A)	51	46	1,00	0,40	30	52	73	71	0,40	76	95
Oven	-		2,60	0,60	36	71	189	186	0,60	115	248
Grill	-		2,50	1,30	63	80	182	179	1,30	122	238
Supply Pressures	Nominal (mbar) Minimum (mbar) Maximum (mbar)						28-30 20 35	37 25 45	20 17 25		

- * At 15°C and 1013 mbar- dry gas
- ** Propane P.C.S. = 50,37 MJ/Kg
- *** Butane P.C.S. = 49,47 MJ/Kg
- Natural P.C.S. = 37,78 MJ/m³

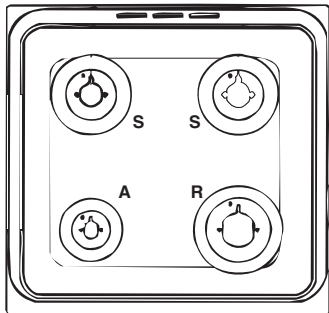

CH50GCIK
CH50GCIW
CH50GCIS

Safety Information

When used properly your appliance is completely safe but as with any electrical product there are certain precautions that must be observed.

PLEASE READ THE PRECAUTIONS BELOW BEFORE USING YOUR APPLIANCE.

Always

- Remove all packing from inside the oven and grill compartments before switching on for the first time.
- Understand the controls prior to using the appliance.
- Keep children away from the appliance when grilling as the surfaces will get extremely hot during and after use.
- Turn controls **off** when you have finished cooking and when not in use.
- Stand back when opening an oven door to allow any build up of steam or heat to disperse.
- Use dry good quality oven gloves when removing items from the oven/grill.
- Place pans centrally over the hotplate making sure handles are kept away from the edge of the hob and cannot become heated by other hotplate/pans.
- Take care to avoid heat/steam burns when operating the controls.
- Turn off the electricity supply at the wall switch before cleaning and allow the appliance to cool.
- Make sure the shelves are in the correct position before switching on the oven.
- Keep the oven and grill doors closed when the appliance is not in use.
- Take care when removing items from the grill when the lower oven is on as the contents will be hot.
- **Keep the appliance clean, as a build up of grease or fat from cooking can cause a fire.**
- Follow the basic principles of food handling and hygiene to prevent the possibility of bacterial growth.
- Keep ventilation slots clear of obstructions.
- Refer servicing to a qualified appliance service engineer.
- Take care to avoid touching heating elements inside the oven, as during use the oven becomes hot.

- The appliance should not be operated by people (including children) with reduced physical, sensory or mental capacities, by inexperienced individuals or by anyone who is not familiar with the product. These individuals should, at the very least, be supervised by someone who assumes responsibility for their safety or receive preliminary instructions relating to the operation of the appliance.
- **The appliance must be used by adults only for the preparation of food, in accordance with the instructions outlined in this booklet. Any other use of the appliance (e.g. for heating the room) constitutes improper use and is dangerous. The manufacturer may not be held liable for any damage resulting from improper, incorrect and unreasonable use of the appliance.**

Safety Information

Never

- Never line the interior of the oven with foil as this may cause the appliance to overheat.
- Never leave children unsupervised where a cooking appliance is installed as all surfaces will be hot during and after its use.
- Do not allow children or persons who are not familiar with the appliance to use it, without supervision.
- Never allow anyone to sit or stand on any part of the appliance.
- Never store items above the appliance that children may attempt to reach.
- Never leave anything on the hob surface when unattended and not in use.
- Never remove the oven shelves whilst the oven is hot.
- Never heat up unopened food containers as pressure can build up causing the container to burst.
- Never store chemicals/food stuffs, pressurised container in or on the appliance, or in cabinets immediately above or next to the appliance.
- Never place flammable or plastic items on or near the hob.
- Never fill a deep fat frying pan more than 1/3 full of oil, or use a lid.
DO NOT LEAVE UNATTENDED WHILE COOKING.
- Never operate the grill with the grill door closed as this will cause the appliance to overheat.
- Never use the appliance as a room heater.
- Never use the grill to warm plates.
- Never dry any items on either the hob or oven doors.
- Never install the appliance next to curtains or other soft furnishings.
- Never use steam cleaners.

SAFETY ADVICE IN CASE OF A CHIP-PAN FIRE

In the event of a chip pan fire or any other pan fire.

1. TURN OFF THE COOKER APPLIANCE AT THE WALL SWITCH.
2. COVER THE PAN WITH A FIRE BLANKET OR DAMP CLOTH, this will smother the flames and extinguish the fire.
3. LEAVE THE PAN TO COOL FOR AT LEAST 60 MINUTES BEFORE MOVING IT. Injuries are often caused by picking up a hot pan and rushing outside with it.

NEVER USE A FIRE EXTINGUISHER TO PUT OUT A PAN FIRE as the force of the extinguisher is likely to tip the pan over.
Never use water to extinguish oil or fat fires.

Features

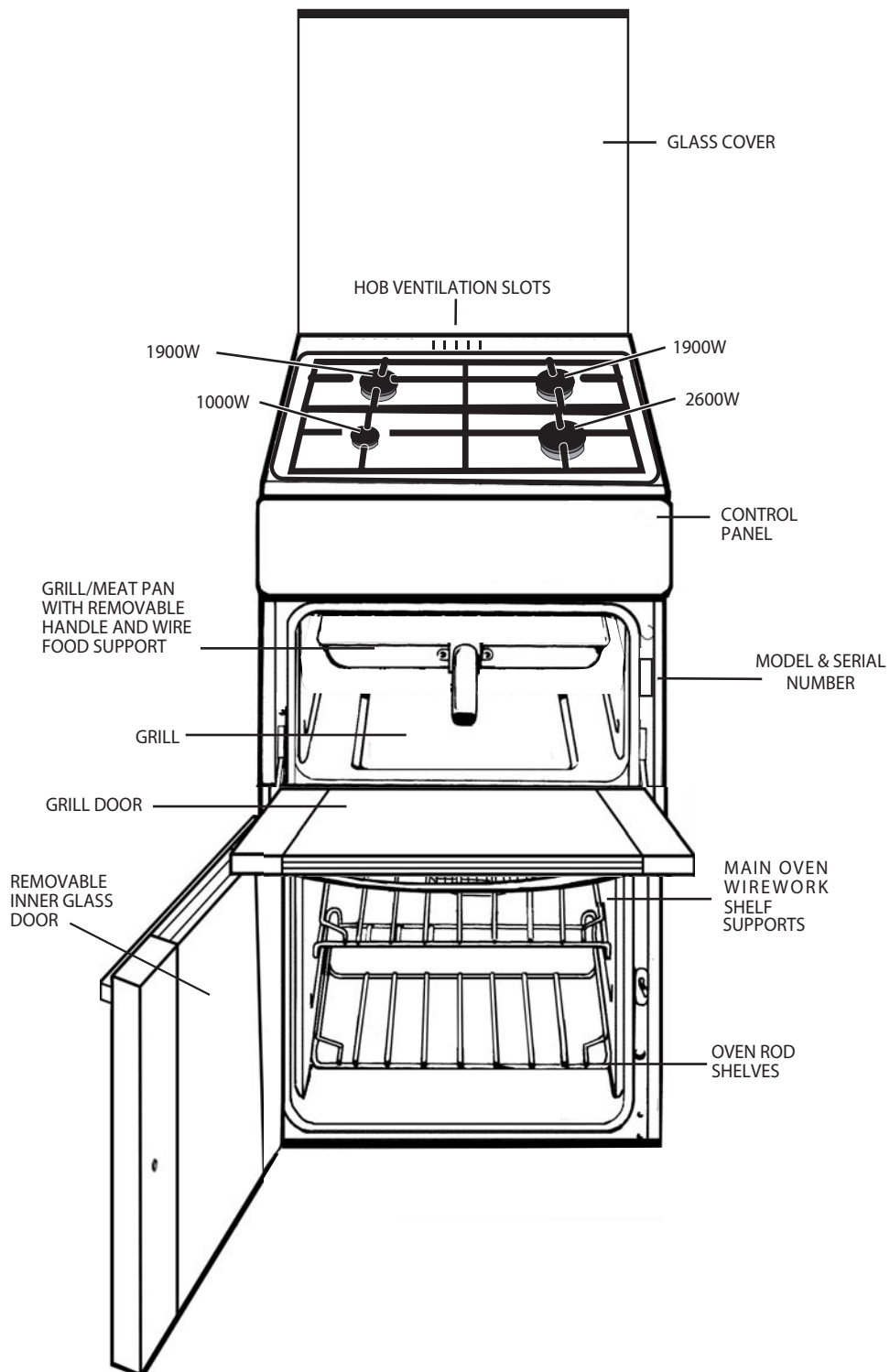

PLEASE PHONE US TO REGISTER YOUR APPLIANCE AND ACTIVATE YOUR PARTS GUARANTEE ON 08448 24 24 24

Control Panel

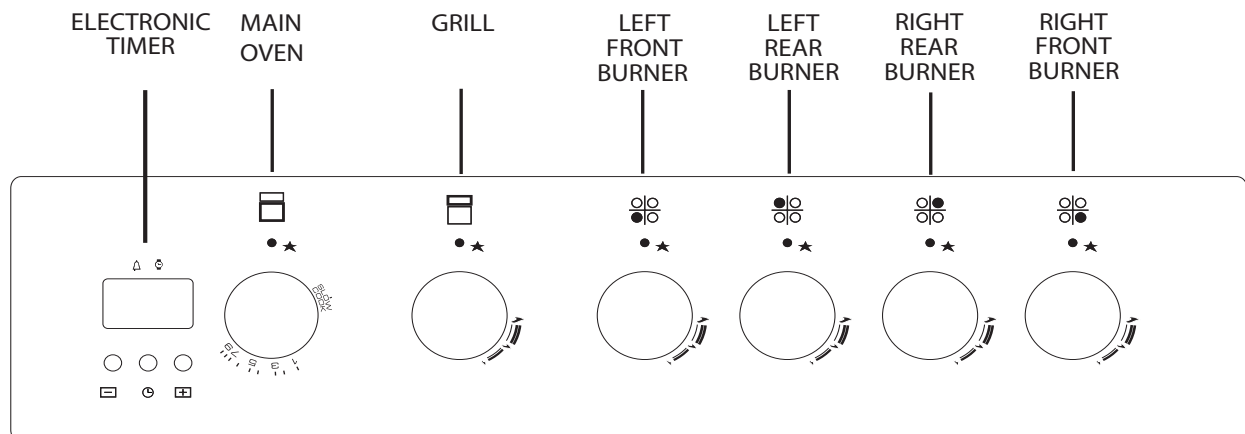

Electronic Ignition for the Gas Hob*

To light a specific burner push the corresponding knob all the way in and turn it counter-clockwise to **maximum** keeping it pressed down until the burner lights.
Important: Should the burner flames accidentally go out, turn off the control knob and wait at least 1 minute before trying to relight.

Control Knobs for the gas burners

The position of the gas burner controlled by each one of the knobs is shown by a solid ring . To light one of the burners press down and turn the corresponding knob counter clockwise to the **maximum** setting. Each burner can be operated at its maximum, minimum or intermediate power. Shown on the knob are the different symbols for off (the knob is on this setting when the symbol corresponds with the reference mark on the control panel), for **maximum** and **minimum** . To obtain these settings, turn the knob counter clockwise with respect to the off position. To turn off the burner, turn the knob clockwise until it stops (corresponding again with the symbol).

Models with Hob Gas Burner Safety Devices to Prevent Leaks *

These models can be identified by the presence of the device itself.
Important: Since the hob burners are equipped with a safety device, you must hold the control knob in for about 3-7 seconds after the burner has been lighted to allow the gas to pass until the safety thermocouple has heated.

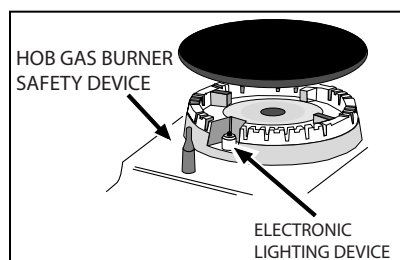

Slow cooking 'SLOWCOOK'

The main oven has a '**SLOWCOOK**' setting specially designed to reduce energy usage. Full details of this can be found in the Slow cooking section of this book.

Electronic timer*

The electronic timer displays the time and the timer function with countdown.

* (only available on certain models)

Use of Hotplates

Practical Advice on Using the Burners

To use the burners as efficiently as possible, some basic guidelines should be followed:

- Use cookware that is the right size for each burner (see table) in order to prevent the flame from spreading beyond the bottom of the cookware.
- Only use cookware with flat bottoms.
- As soon as the boiling point is reached, turn the knob to the lowest setting.
- Always use lids with pots and pans.

Burner	∅ Cookware diameter (cm)
Fast (R)	20 - 22
Semi Fast (S)	16 - 20
Auxiliary (A)	10 - 14

N.B.: On models equipped with a reduction grid, the grid should only be used with the auxiliary burner when cookware with a diameter of less than 12 cm is used.

1. To light a specific burner push the corresponding knob all the way in and turn it counter-clockwise to **maximum**  keeping it pressed down until the burner lights.
2. Turn the control knob anti-clockwise to the desired setting. Only turn the control knob between the large flame symbol and the small flame symbol for adjusting the setting.
3. To turn off, turn the control knob fully clockwise to the symbol **O**.

DO NOT use the hotplate unless all pan supports are in position.

DO NOT use mis-shapen pans which may be unstable.

DO NOT use round base woks directly on the pan supports.

DO NOT use the glass lid (if fitted) as a working surface.

Each burner is fitted with a spark ignitor for lighting the gas. To ensure rapid lighting of the burners every time they are used, the ignitors must be kept **clean and dry**. Remove any food spillage or cleaning materials from the electrode using a small nylon brush such as a tooth brush. Access to the electrode can be achieved by lifting off the loose burner parts carefully when the burners are cool.

When the hotplate burner bodies and caps are removed for cleaning, be careful not to drop any food particles or cleaning materials into the burner bases, to avoid the possibility of blocking the gas jets.

If aluminium based pans are used, a silvery deposit may appear on the top edge of the pan support fingers. See 'Care and Cleaning' section for cleaning information.

SAFETY REQUIREMENTS FOR DEEP FAT FRYING

1. Never fill chip pans more than one third full with oil or fat.
2. Never leave oil or fat unattended during the heating or cooling period.
3. Never heat fat or fry with a lid on the pan.
4. Always dry food thoroughly before frying, and lower it slowly into the hot oil or fat. Frozen foods in particular will cause frothing and spitting if added too quickly.
5. Always keep the outside of the pan clean and free from streaks of oil or fat.

HOW TO DEAL WITH A FAT FIRE

1. Do not move the pan.
2. Turn off the hotplate burners.
3. Smother the flames with a fire blanket or damp cloth to extinguish the fire. Do not use water or a fire extinguisher as the force of it may spread the burning fat or oil over the edge of the pan.
4. Leave the pan for at least 60 minutes before moving it.

N.B.: After prolonged use of the gas hob there may be some small amount of discolouration in the area around the large burners. This is normal and can be easily removed using proprietary stainless steel cleaning agents. We have included a sample of our own recommended stainless steel cleaner which will help maintain your new cooker in pristine condition.

PLEASE PHONE US TO REGISTER YOUR APPLIANCE AND ACTIVATE YOUR PARTS GUARANTEE ON 08448 24 24 24

Use of Grill

**GRILLING MUST BE DONE WITH THE GRILL DOOR OPEN.
CONTROL KNOBS MAY BECOME HOT DURING GRILLING.
CAUTION: ACCESSIBLE PARTS WILL BECOME HOT WHEN THE GRILL
IS USED - CHILDREN SHOULD BE KEPT AWAY.**

To operate the grill proceed as follows:

- Open the grill door and remove the grill pan.
- Push in and turn the control knob clockwise to the large flame symbol. Continue to push in the control knob for at least a further 5 seconds after the gas has lit, to allow time for the safety device to operate. If the burner extinguishes when the control knob is released, repeat the procedure ensuring the control knob is fully depressed and allowing more time for the safety device to operate.

Grill Pan Handle

- Turn the control knob anti-clockwise to the desired setting. There is a delay of about six seconds whilst the safety device operates before the burner comes on full. Only turn the control knob between the large flame symbol and the small flame symbol when adjusting the setting.

Slide the grill pan along the runner towards the rear of the grill compartment until it stops. An odour may be noticed when first using the grill - this should cease after a short period of use. **Grill can be started from cold but for the best result preheat for approximately five minutes.** Most cooking is done with the heat on full, but it may be necessary after sealing the food to reduce the heat as required.

For au gratin dishes eg. Macaroni Cheese and meringue toppings eg. Baked Alaska place the dish on the floor of the grill compartment. The base of the grill pan can be used for warming fruit garnishes on the reduced setting.

DO NOT cover the grill pan or grid with aluminium foil as this can hold fat, intensify the heat and create a fire hazard.

Relighting the burner

In the event of the burner flames being accidentally extinguished, turn off the burner control and do not attempt to re-ignite the burner for at least one minute.

Fixing the Grill Pan Handle

The grill pan handle is detachable from the pan to facilitate cleaning and storage. Fix the pan handle securely before use:

1. Fit the handle to the grill pan so that the external 'hooks' embrace the edge of the pan (fig. 1)
2. Make sure that the middle part of the handle fits exactly the protruding support of the pan (fig 2) and holds the pan from the bottom.

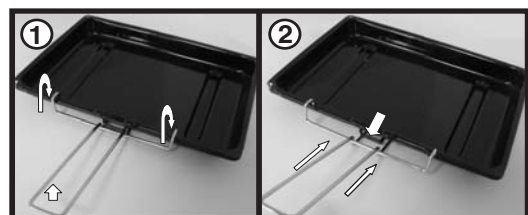

The food must be placed on the rack in the grill pan.

Position the grill pan on top of the oven rack. The best results are achieved by placing the oven rack on the uppermost shelves. Pouring a little water into the grill pan will make the collection of grease particles more efficient and prevent the formation of smoke.

1 panel (see figure) in order to prevent the knobs from overheating

Use of Main Oven

The oven has different heat zones - the thermostat settings refer to the temperature on the middle shelf; above this shelf it is to food. Shelves are removed from the oven by pulling them out to the stop and then lifting them at the front to withdraw. The grill pan without the handle can be used in the oven. The maximum size of baking tray that should be used is 300mm x 330mm (12"x13").

- TO USE THE OVEN
- Place oven shelves in the chosen positions (refer to cooking charts).
 - Push in and turn the control knob fully anti-clockwise. Continue to push in the control knob for at least a further 5 seconds after the gas has lit to allow time for the safety device to operate. If the burner extinguishes when the control knob is released, repeat the procedure ensuring the control knob is fully depressed and allowing more time for the safety device to operate.
 - Turn the control knob clockwise to the required setting (refer to cooking chart). There is a delay of about six seconds whilst the safety device operates before the burner comes on full.
 - To turn off, turn the control knob fully clockwise to the symbol 0.
- Never place dishes on the oven base over the burner.
An odour may be noticed when first using the oven - this should cease after a short period of use.
- The oven temperature control markings are gas marked 0 to 9.
- The equivalent degrees Celsius (sometimes called Centigrade) and degrees Fahrenheit are shown below as a guide.

Gas Mark	MAIN OVEN (Centre Oven Temperature)	
	Celsius °C	Fahrenheit °F
S	110	229
1	145	290
2	160	320
3	180	355
□	195	385

Gas Mark	MAIN OVEN (Centre Oven Temperature)	
	Celsius °C	Fahrenheit °F
5	210	410
□	220	430
7	230	445
□	240	465
9	245	475

COLD START COOKING

Anything requiring long slow cooking such as casseroles and rich fruit cakes can be put into a cold oven. Satisfactory results can also be obtained with creamed mixture, rich pastries or yeast mixtures, but for perfection we recommend preheating the oven for about 15 minutes.

ROASTING OF LARGE POULTRY

The maximum weight of poultry that can be accommodated is 8kg (18 lbs) of suitable shape. It is important to check that the bird DOES NOT overhang the burner at the back of the oven.

STORAGE AND RE-HEATING OF FOOD

It is vitally important to strictly adhere to the basic principles of food handling and hygiene to prevent the possibility of bacterial growth.

- If food is to be frozen or not served immediately, cool it in a clean container as quickly as possible.
- Completely thaw frozen food in the refrigerator before reheating.
- Re-heat food thoroughly and quickly either on the hotplate or in a hot oven, Mk. 6, and then serve immediately.
- Only re-heat food once.

'COOK CHILL' DISHES

These should always be placed in a pre-heated oven ideally on the first or second shelf position. Follow the packet instructions for cooking time.

ALUMINIUM FOIL

If using Aluminium Foil:

- Remember that it is important to increase the cooking time by one third.
- Never allow the foil to touch the sides of the oven.
- Never cover the oven interior with foil.
- Never cover the oven shelves with foil.

* Available only for certain models

PLEASE PHONE US TO REGISTER YOUR APPLIANCE AND ACTIVATE YOUR PARTS GUARANTEE ON 08448 24 24 24

Oven Cooking Chart

The following times and setting are for guidance only. You may wish to alter the setting to give a result more to your satisfaction. When a different setting to that shown below is given in a recipe, the recipe instructions should be followed. Allow 15 minutes preheat for best results. Always turn the thermostat knob to Mark 9 before selecting the appropriate gas Mark. Shelf position 1 is the highest.

Food	Gas Mark	Shelf Position	Approx. Cooking Time and Comments
Fish			
Oily and white fish	3 or 4	4	25-60 mins. depending on recipe
Meat and Poultry			
Beef	4 or 5	4	25-30 mins per 450g (1 lb) + 25 mins. extra
Ham	5	4	40 mins per 450g (1 lb) covered in foil plus 40 mins. extra
Lamb	5	4	30 mins per 450g (1 lb) + 30 mins extra
Pork	5	4	40 mins per 450g (1 lb) + 40 mins extra
Chicken	5	4	25 mins per 450g (1 lb) + 25 mins extra
Duckling & Goose	5	4	25 mins per 450g (1 lb) + 25 mins extra
Turkey	4 or 5	4 or 5	15-20 mins per 450g (1 lb) + 20 mins
Casseroles	3	3or4	2-6 hrs. depending on cut of meat
Vegetables			
Baked jacket potatoes	4 or 5	3	1½ - 3 hrs. until soft, depending on size
Puddings			
Milk Puddings (500ml/1 pt)	3	4	1¼-2½ stand dish on baking tray and started with warm milk
Baked Custard (500ml/1 pt)	3	4	45-60 mins. bain-marie
Baked Sponge Puddings	4	3	40-50 mins
Baked Apples	3	3	30-45 mins depending on type and size of apples
Meringue Topped Puddings	1	3or4	15 mins or until "tinged" with brown
Apple Tart (1 x205mm/8")	6	2	45-60 mins
Fruit Crumble	5	2	35 -45 mins
Cakes, Pastries & Biscuits			
Small Cakes 2 trays	5	2 and 4	15-25 mins.
1 tray	5	2	15-22mins.
Victoria sandwich (2 x 7")	4	2 and 4	20-30 mins
Swiss Roll (3 egg quantity)	5	2	15-20 mins.
Meringues	1	3	2-3 hrs
Christmas cake (1 x 205mm / 8")	2	3	Time depending on recipe
Madeira cake (1 x 180mm / 7")	4	4	1¼-1½ hrs.
Rich Fruit cake (1 x 180mm / 7")	2	4	Time depending on recipe
Scones	7	1 and 3	10-20 mins.
Shortbread (1 x 180mm / 7")	2	3	55 -65 mins.
Biscuits	4	1 and 3	10-20 mins.
Shortcrust Pastry	6	2	15 - 60 mins depending on use.
Rich Short Crust	5	1 and 3	20-30 mins.
Flaky/Puff Pastry	7	2	10-30 mins.
Choux Pastry	6	2	20-30mins.
Yeast Mixtures			
Bread - rolls	7	2 and 4	20-30 mins.
Miscellaneous			
Yorkshire Pudding:- large	7	1	30-40 mins
individual	7	2	20-30mins

When baking with two trays or tins on two levels, the top tray is removed first and the lower tray moved up to the top position for a few minutes longer.

Soft Margarine -

Use the oven settings recommended by the margarine manufacturer and **not** those indicated on the cooking chart.
PLEASE PHONE US TO REGISTER YOUR APPLIANCE AND ACTIVATE YOUR PARTS GUARANTEE ON 08448 24 24 24

Using the Main Oven for Other Functions

'SLOWCOOK'

SLOW Setting

This is used for slow cooking, keeping food warm and warming plates for short periods. Extra care should be taken when warming bone china, as it may be damaged in a hot oven.

DO NOT place food or plates directly on the oven floor as this could damage both the oven lining and the plates which are being warmed.

Advantages of "SLOW" cooking are:

The oven stays cleaner because there is less splashing.
Timing of food is not as critical, so there is less fear of overcooking.
Inexpensive joints of meat are tenderised.
Fully loading the oven can be economical.
Cooking times can be extended in some cases by up to 2 hours.

Operation:

1. Place the prepared food in the main oven and ensure the door is fully closed.
2. Select 'SLOWCOOK' (Slow Cooking Temperature) by turning the Main Oven Control clockwise ensuring the oven door is fully closed.

Storage and re-heating of food:

1. If food is to be frozen or not used immediately, place it in a clean container and cool as soon as possible.
2. Always thaw frozen food completely in the refrigerator before re-heating.
3. Always reheat food thoroughly and ensure it is piping hot before serving.
4. Only re-heat food once.

Points to consider when preparing food for "SLOW" cooking:

1. Make sure that the dishes to be used will fit into the oven ensuring enough room for air to circulate.
2. All dishes cooked on the slow setting will require a minimum of 6 hours, however, **if** they are cooked for 1 -2 hours longer then deterioration in their appearance may be noticed.
3. Never cook joints of meat over 2.7kg (6 lb) or poultry over 2.0kg (4lb 8oz).
We do not recommend that joints of meat or poultry are stuffed before cooking on the slow setting.
4. To seal in the meat juices, always cook meat or poultry at 170°C for 30 minutes before wrapping in foil and placing on a rack over a tin (to allow good air circulation) before turning the control to the slow setting and cooking immediately.
5. Always ensure that joints of pork and poultry are thoroughly cooked by checking with a meat thermometer before serving.
6. Always thaw frozen foods completely before cooking. We do not recommend placing frozen food in the oven to cook.
7. Always bring soups, liquids and casseroles to the boil before placing in the oven.
8. Ensure that casserole dishes have a good seal (not airtight) and cover to the top with foil to prevent loss of moisture.
9. Ensure that fruit and vegetables are cut into even sized small pieces to cook properly.
- 10.** Always adjust seasoning before serving.
11. If using dried red kidney beans it is important that the beans are soaked and then boiled for a minimum of 10 minutes before using in any dish to destroy any toxins.
12. When cooking fish or egg dishes it may be necessary to check during cooking to avoid overcooking.

Care and Cleaning

- Grill** Remove the grill pan and the wire grid food support, it is best to wash these items immediately after use to prevent stains from being burnt on when used again. Wipe out the Grill compartment, use a fine steel wool soap pad to remove stubborn stains from the grill runners and the floor of the compartment. Wipe over the control panel with a damp cloth and polish with a dry cloth.
- Control Panel** **Do not use** cream cleaners, oven cleaners or aerosols, scouring pads or abrasive powder for cleaning the plastic knobs as damage will occur.
- Decorative Trims** It is advisable to clean the decorative trims regularly to prevent any build up of soiling. The recommended method of cleaning is to wipe over the trims with a soft cloth wrung out in warm water or mild non-abrasive cleaner. (If in doubt try the cleaner on a small area of trim which is not noticeable in normal use). Then, after wiping with a cloth wrung out in clear water, dry with a soft clean cloth.
- Doors** Wipe over the outer door glass panels with a cloth wrung out in warm soapy water, then after wiping with a cloth wrung out in clear water, dry with a soft clean cloth. **Ensure that glass doors are not subjected to any sharp mechanical blows.**
Glass Inner Door Panel (where fitted) – open the door fully and carefully slide the inner glass towards you, taking care not to allow the glass to fall. The glass panel may now be washed at the sink. Stubborn stains can be removed by using a fine steel wool soap pad. **Ensure the glass panel is not subjected to any sharp mechanical blows.** Take particular care not to damage the inner surface which is coated with a heat reflective layer. After cleaning, rinse and dry with a soft cloth. For slight soiling the inner glass panel may be cleaned, while still warm, without removing it from the door.
 Warning: Oven must not be operated with inner door glass removed.
Take care during cleaning not to damage or distort the door seals. Do not lift the door seal from the oven chassis, if necessary remove the seal by carefully unhooking the corner clips.
Take care that the rating label edges are not lifted during cleaning, and furthermore that the lettering is not blurred or removed.
- Ovens** Remove the rod shelves and grill pan. Use a fine steel wool soap pad to remove stubborn stains from the rod shelves, grill pan and the floor of the oven. Clean the glass part of the oven door using a sponge and a non-abrasive cleaning product, then dry thoroughly with a soft cloth. Do not use rough abrasive material or sharp metal scrapers as these could scratch the surface and cause the glass to crack.
- Oven Shelf Supports** The shelf supports are removable and dishwasher safe.
To remove hold the support at the front and pull away from the oven side, this can then be cleaned in a sink or a dishwasher. When removed it allows access to the oven side, which can be cleaned with warm soapy water.
To refit the support, insert the longer leg into the rear fixing hole and push in the front leg.
- Oven Lamp Replacement** Open the oven door and remove the rod shelves. Using a suitable cloth to protect the fingers grip the light glass dome, unscrew anti-clockwise and lift. Reach into the aperture with fingers, and unscrew the lamp anticlockwise. Fit replacement lamp (25W 300°C rated SES), refit dome.
- WARNING: To avoid electric shocks - please ensure that the electricity supply to the appliance is switched off and the appliance is fully cold, before removing the lamp lens.**
- 'Stay Clean' Pannel*** 'Stay Clean' panels are covered with a special enamel which absorbs cooking soils. At higher temperatures the soiling is slowly destroyed. In most cases normal cooking at higher temperatures will permit this cleaning to take place automatically. However, if higher cooking temperatures are not used regularly then it may be necessary, in order to prevent heavy soiling, to run the oven at maximum temperature for at least two hours, from time to time. The 'Stay Clean' panel can be washed in warm soapy water followed by rinsing in clear water. Dry well with a soft cloth.
 NOTE: Do not use enzyme washing powder, harsh abrasives or chemical oven cleaners of any kind.
***In the models: C50GL; C50 LC/1 and C50GC/1 Stay Clean' Pannel is present only in the Main Oven.**
- Oven Fittings** The oven shelves can be cleaned either in a dishwasher or by using a fine steel wool soap pad. The grill and meat pans can be cleaned in warm soapy water using a fine steel wool soap pad to remove stubborn stains or in a dishwasher. They should be cleaned after each use.
- Oven Interiors** To clean the oven interiors remove all the oven fittings and where applicable the 'Stay Clean' liners. All types of oven cleaners can be used, but **do not** allow abrasive cleaners or oven spray to come into contact with the 'Stay Clean' liners. Use a fine steel wool soap pad to remove stubborn stains.

Cooking Results Not Satisfactory?

Problem	Check
Grilling Uneven cooking front to back	Ensure that the grill pan is positioned centrally below the grill element.
Fat splattering	Ensure that the grill is not set to too high a temperature.
Oven Baking Uneven rising of cake	Ensure that the oven shelves are level by using a spirit level on the rod shelf and adjusting, using suitable packing e.g. wood, under the feet of the appliance. This should be checked both left to right and front to back. Ensure that the food is positioned centrally in the oven.
Sinking of cakes	The following may cause cakes to sink: 1. Cooking at too high a temperature. 2. Using normal creaming method with soft margarine.
Over/Under cooking Fast/Slow cooking	Refer to the cooking times and temperatures given in the oven temperature charts, however, it may be necessary to increase or decrease temperatures by 10°C to suit personal taste. Do not use utensils greater than 2¼ ins in height.

Something Wrong with your Cooker?

Before contacting your nearest Service Centre/Installer, check the problem guide below; there may be nothing wrong with your cooker.

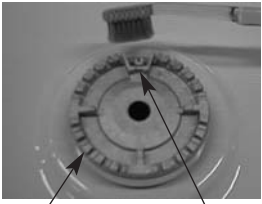
PROBLEM	CHECK
<p>Burner will not light:</p> <p style="text-align: center;"><i>Hotplate burner:</i></p>  <p style="text-align: center;">Burner ports Ignitor</p>	<p><u>If all burners fail to ignite:</u> Check that sparks appear at the burners; a clicking noise should be heard. If not;</p> <p>Check that the electricity supply is turned on. If the electricity supply has failed, all burners can be lit by a match.</p> <p><u>If only one burner fails to ignite:</u> Check that the burner is dry and that spillage of food or cleaning fluid remains are not affecting the ignitor or burner ports. Clean away any debris with a dry nylon brush such as an old toothbrush. If a wire wool pad has been used for cleaning around the burner ensure the ignitor is free from any stray strands. Any water on the burner should be dried with a cloth or kitchen towel.</p> <p>Make sure that all the burners parts are correctly seated.</p>

Technical Characteristics

Oven

Dimensions (HxWxD): 34x37,5x34 cm

Volume: 43 Litres

Voltage and Frequency

220-240V~ 50Hz

Burners:

Adaptable for use with all the types of gas indicated on the data plate.



This appliance conforms with the following European Economic Community directives:

- 2006/95/EC of 12/12/06 (Low Voltage) and subsequent modifications;
- 2004/108/EC of 15/12/04 (Electromagnetic Compatibility) and subsequent modifications;
- 90/396/EEC of 29/06/90 (Gas) and subsequent modifications (only for models which use gas);
- 93/68/EEC of 22/07/93 and subsequent modifications.
- 2002/96/EC

The European Directive 2002/96/EC on Waste Electrical and Electronic Equipment (WEEE), requires that old household electrical appliances must not be disposed of in the normal unsorted municipal waste stream. Old appliances must be collected separately in order to optimise the recovery and recycling of the materials they contain and reduce the impact on human health and the environment. The crossed out "wheeled bin" symbol on the product reminds you of your obligation, that when you dispose of the appliance it must be separately collected.

Consumers should contact their local authority or retailer for information concerning the correct disposal of their old appliance.

Mains frequency and voltage of the electric section and characteristics of the gas section

Model	Gas section	
	Class	Rated power kW (1)
CH50GCIK CH50GCIW CH50GCIS	112H3+	12,50 (909 g/h - G30) (893 g/h - G31)

(1) The values in g/h refer to the capacities with liquid gas (Butane, Propane).





PLEASE PHONE US TO REGISTER YOUR APPLIANCE AND ACTIVATE YOUR PARTS GUARANTEE ON 08448 24 24 24

Electronic timer

The electronic timer displays the time and the timer function with countdown.

To set the clock





Note: This may be set while the oven is switched off or while it is switched on.

1. Press the  button several times until the  icon and the first two numerical digits on the display start to flash.
2. Use the "+" and "-" buttons to adjust the hour value.
3. Press the  button again so that the other two numerical digits on the DISPLAY begin to flash.
4. Use the "+" and "-" buttons to adjust the minute value.
5. Press the  button again to confirm.

Note: If none of the buttons are pressed, the settings will be confirmed automatically after 10 seconds have passed.

To set the minute minder

Note: This function does not interrupt cooking and does not affect the oven; it is simply used to activate the buzzer when the set amount of time has elapsed.

1. Press the  button several times until the  icon and the first two numerical digits on the display start to flash.
2. Use the "+" and "-" buttons to adjust the hour value.
3. Press the  button again so that the other two numerical digits on the DISPLAY begin to flash.
4. Use the "+" and "-" buttons to adjust the minute value.
5. Press the  button again to confirm.

The countdown will then be displayed; at the end of this period of time the buzzer will sound (this may be stopped by pressing any of the buttons, or it will stop of its own accord after one minute).

To cancel a previous setting

Press button "-" up until 0 • 00.

Hotpoint Guarantee

12 months Parts and Labour Guarantee

Your appliance has the benefit of our manufacturer's guarantee, which covers the cost of breakdown repairs for twelve months from the date of purchase.

This gives you the reassurance that if, within that time, your appliance is proven to be defective because of either workmanship or materials, we will, at our discretion, either repair or replace the appliance at no cost to you.

The guarantee is subject to the following conditions:

- The appliance has been installed and operated correctly and in accordance with our operating and maintenance instructions.
- The appliance is only used on the electricity or gas supply printed on the rating plate.
- The appliance has been used for normal domestic purposes only.
- The appliance has not been altered, serviced, maintained, dismantled or otherwise interfered with by any person not authorised by us.
- Any repair work must be undertaken by us or our appointed agent.
- Any parts removed during repair work or any appliance that is replaced become our property.
- The appliance is used in the United Kingdom or Republic of Ireland.

The guarantee does not cover:

- Damage resulting from transportation, improper use, neglect or interference or as a result of improper installation.
- Replacement of any consumable item or accessory. These include but are not limited to: plugs, cables, batteries, light bulbs, fluorescent tubes and starters, covers and filters.
- Replacement of any removable parts made of glass or plastic.

THE GUARANTEE WILL NOT APPLY IF THE APPLIANCE HAS BEEN USED IN COMMERCIAL OR NON-DOMESTIC PREMISES.

5 Year Parts Guarantee

Hotpoint also offers you a FREE 5 year parts guarantee. This additional guarantee is conditional on you registering your appliance with us and the parts being fitted by one of our authorised engineers. There will be a charge for our engineer's time. To activate the extra parts warranty on your appliance, simply call our registration line on **08448 24 24 24 (ROI 01 230 0800)**

Extended Guarantees

We offer a selection of protection plans that enable you to fully cover yourself against the expense of repair bills for the life of your policy. To find the ideal plan for you please call our advice line on **08448 226 226 (ROI 01 230 0233)**

Free Helpdesk Service

We have a dedicated team who can provide free advice and assistance with your appliance if you experience any technical difficulties within the first 90 days of ownership.

Simply call our Hotpoint Service Hotline on **08448 224 224 (ROI 0818 313 413)** for telephone assistance, or, where necessary, to arrange for an engineer to call.

PLEASE PHONE US TO REGISTER YOUR APPLIANCE AND ACTIVATE YOUR PARTS GUARANTEE ON 08448 24 24 24
22



After Sales Service

No one is better placed to care for your Hotpoint appliance during the course of its working life than us - the manufacturer.

Essential Contact Information

Hotpoint Service

We are the largest service team in the country offering you access to 400 skilled telephone advisors and 1100 fully qualified engineers on call to ensure you receive fast, reliable, local service.

UK: 08448 224 224

Republic of Ireland: 0818 313 413

www.hotpoint.co.uk

Please note: Our advisors will require the following information:

Model number

Serial number

Parts & Accessories

We supply a full range of genuine replacement parts as well as accessory products that protect and hygienically clean your appliance to keep it looking good and functioning efficiently throughout its life.

UK: 08448 225 225

Republic of Ireland: 0818 313 413

www.hotpointservice.co.uk

Appliance Registration

We want to give you additional benefits of Hotpoint ownership. To activate your FREE 5 year parts guarantee you must register your appliance with us.

UK 08448 24 24 24

Republic of Ireland: 01 230 0800

www.hotpointservice.co.uk

As part of Hotpoint's continued commitment to helping the environment, Hotpoint reserves the right to use quality, recycled components to keep down customer costs and minimise material wastage.

Indesit Company UK Limited, Morley Way, Peterborough, PE2 9JB

Indesit Company, Unit 49 Airways Industrial Estate, Dublin 17

10/2011- 195088175.00
XEROX FABRIANO

PLEASE PHONE US TO REGISTER YOUR APPLIANCE AND ACTIVATE YOUR PARTS GUARANTEE ON 08448 24 24 24
24

Free Manuals Download Website

<http://myh66.com>

<http://usermanuals.us>

<http://www.somanuals.com>

<http://www.4manuals.cc>

<http://www.manual-lib.com>

<http://www.404manual.com>

<http://www.luxmanual.com>

<http://aubethermostatmanual.com>

Golf course search by state

<http://golfingnear.com>

Email search by domain

<http://emailbydomain.com>

Auto manuals search

<http://auto.somanuals.com>

TV manuals search

<http://tv.somanuals.com>