

GB

English, 1

CIC 642 C
CIA 641 C S

Contents

Warnings, 2

Installation, 3-4

Positioning
Electrical connection

Description of the appliance, 5

Control panel

Start-up and use, 6-9

Switching on the hob
Switching on the cooking zones
Booster function
Switching off the cooking zones
Programming the cooking duration
Timer
Control panel lock
Switching off the hob
"Demo" mode
Practical advice on using the appliance
Safety devices
Practical cooking advice

Precautions and tips, 10

General safety
Disposal

Care and maintenance, 11

Switching the appliance off
Cleaning the appliance
Disassembling the hob

Technical description of the models, 11

After Sales Service, 12

Guarantee, 13

- **WARNING:** The appliance and its accessible parts become hot during use.
- Care should be taken to avoid touching heating elements.
- Children less than 8 years of age shall be kept away unless continuously supervised.
- This appliance can be used by children aged from 8 years and above and persons with reduced physical, sensory or mental capabilities or lack of experience and knowledge if they have been given supervision or instruction concerning use of the appliance in a safe way and understand the hazards involved. Children shall not play with the appliance. Cleaning and user maintenance shall not be made by children without supervision.
- **WARNING:** Unattended cooking on a hob with fat or oil can be dangerous and may result in fire.
- **NEVER** try to extinguish a fire with water, but switch off the appliance and then cover flame e.g. with a lid or a fire blanket.
- **WARNING:** Danger of fire: do not store items on the cooking surfaces.
- **WARNING:** If the surface in glass-ceramic is cracked, switch off the appliance to avoid the possibility of electric shock.
- Never use steam cleaners or pressure cleaners on the appliance.
- The appliance is not intended to be operated by means of an external timer or separate remote control system.
- Do not place metal objects (knives, spoons, pan lids, etc.) on the hob as they may become hot.
- After use, switch off the hob element by its control and do not rely on the pan detector.

Installation

GB

! Before operating your new appliance please read this instruction booklet carefully. It contains important information concerning the safe operation, installation and maintenance of the appliance.

! Please keep these operating instructions for future reference. Pass them on to any new owners of the appliance.

Positioning

! Keep all packaging material out of the reach of children. It may present a choking or suffocation hazard (see *Precautions and tips*).

! The appliance must be installed by a qualified professional in accordance with the instructions provided. Incorrect installation may cause harm to people and animals or may damage property.

Built-in appliance

Use a suitable cabinet to ensure that the appliance functions properly.

- The supporting surface must be heat-resistant up to a temperature of approximately 100°C.
- If the appliance is to be installed above an oven, the oven must be equipped with a forced ventilation cooling system.
- Avoid installing the hob above a dishwasher: if this cannot be avoided, place a waterproof separation device between the two appliances.
- Depending on the hob you want to install, the cabinet must have the following dimensions (see figure):

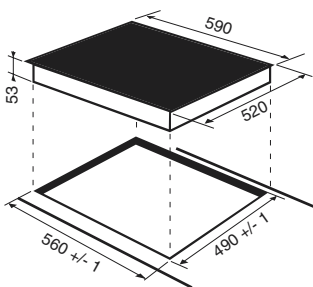

Ventilation

To allow adequate ventilation and to avoid overheating of the surrounding surfaces the hob should be positioned as follows:

- At a minimum distance of 40 mm from the back panel or any other vertical surfaces.
- So that a minimum distance of 20 mm is maintained between the installation cavity and the cabinet underneath.
- Kitchen cabinets adjacent to the appliance and taller than the top of the hob must be at least 600 mm from the edge of the hob.

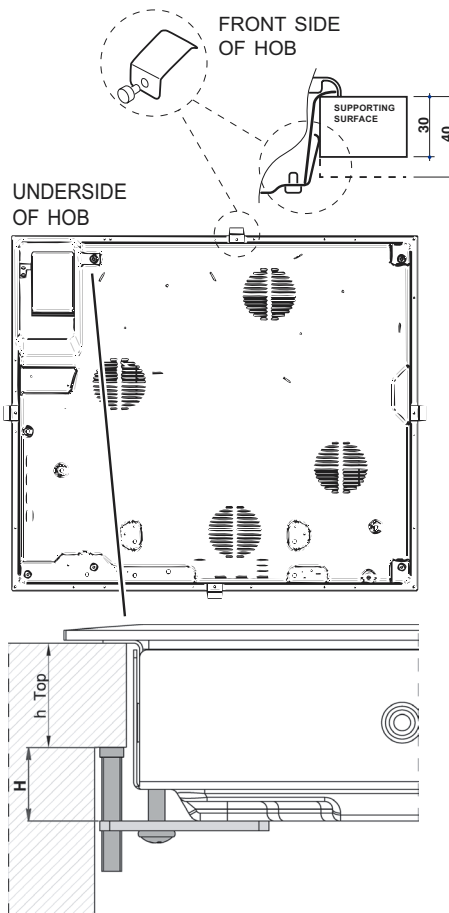
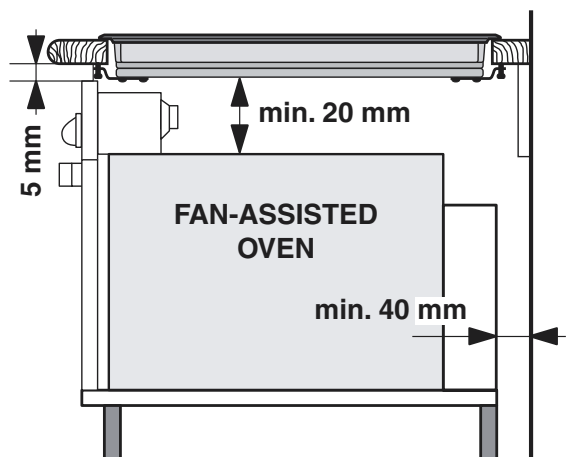
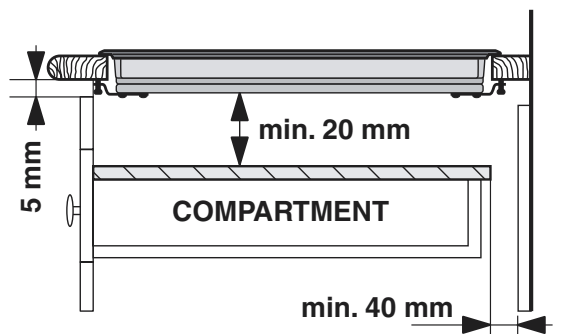

Fixing

The appliance must be installed on a perfectly level supporting surface.

Any deformities caused by improper fixing could affect the features and operation of the hob.

The thickness of the supporting surface should be taken into account when choosing the length of the screws for the fixing hooks:

- 30 mm thick: 23 mm screws
- 40 mm thick: 13 mm screws

Fix the hob as follows:

1. Use short flat-bottomed screws to fix the 4 alignment springs in the holes provided at the central point of each side of the hob.
2. Place the hob in the cavity, make sure it is in a central position and push down on the whole perimeter until the hob is stuck to the supporting surface.
3. For hobs with raised sides: After inserting the hob into its cavity, insert the 4 fixing hooks (each has its own pin) into the lower edges of the hob, using the long pointed screws to fix them in place, until the glass is stuck to the supporting surface.

! The screws for the alignment springs must remain accessible.

! In order to adhere to safety standards, the appliance must not come into contact with electrical parts once it has been installed.

! All parts which ensure the safe operation of the appliance must not be removable without the aid of a tool.

Electrical connection

! The electrical connection for the hob and for any built-in oven must be carried out separately, both for safety purposes and to make extracting the oven easier.

Single-phase connection

The hob is equipped with a pre-connected electricity supply cable, which is designed for single-phase connection. Connect the wires in accordance with the instructions given in the following table and diagrams:

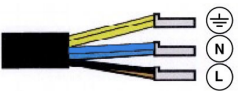
Voltage and mains frequency	Electrical cable	Wire connection
220-240V 1+N ~ 50 Hz		⊕ : yellow/green N : the two blue wires together L : brown and black together

Other types of connection

If the mains supply corresponds with one of the following:

Voltage and mains frequency

- 400V - 2+N ~ 50 Hz
- 220-240V 3 ~ 50 Hz

- 400V 3 - N ~ 50 Hz
- 400V - 2+2N ~ 50 Hz

Separate the wires and connect them in accordance with the instructions given in the following table and diagrams:

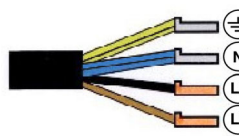
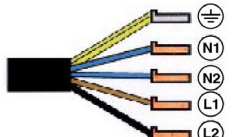
Voltage and mains frequency	Electrical cable	Wire connection
400V - 2+N ~ 50 Hz 220-240V 3 ~ 50 Hz 400V 3-N ~ 50 Hz		⊕ : yellow/green; N : the two blue wires together L1 : black L2 : brown
400V - 2+2N ~ 50 Hz		⊕ : yellow/green; N1 : blue N2 : blue L1 : black L2 : brown

Connecting the electricity supply cable to the mains

If the appliance is being connected directly to the electricity mains an omnipolar switch must be installed with a minimum opening of 3 mm between contacts.

! The installer must ensure that the correct electrical connection has been made and that it is fully compliant with safety regulations.

Before connecting the appliance to the power supply, make sure that:

- The appliance is earthed and the plug is compliant with the law.
- The socket can withstand the maximum power of the appliance, which is indicated on the data plate located on the appliance itself.
- The voltage falls within the range of values indicated on the data plate.
- The socket is compatible with the plug of the appliance. If the socket is incompatible with the plug, ask an authorised technician to replace it. Do not use extension cords or multiple sockets.

! Once the appliance has been installed, the power supply cable and the electrical socket must be easily accessible.

! The cable must not be bent or compressed.

! The cable must be checked regularly and replaced by authorised technicians only.

! The manufacturer declines any liability should these safety measures not be observed.

! Do not remove or replace the power supply cable for any reason. Its removal or replacement will void the warranty and the CE marking. INDESIT does not assume liability for accidents or damage arising from replacement/removal of the original power supply cable. Replacement can only be accepted when carried out by personnel authorised by INDESIT and using an original spare part.

Description of the appliance

GB

Control panel

The control panel described in this manual is only a representative example: it may not exactly match the panel on your appliance.

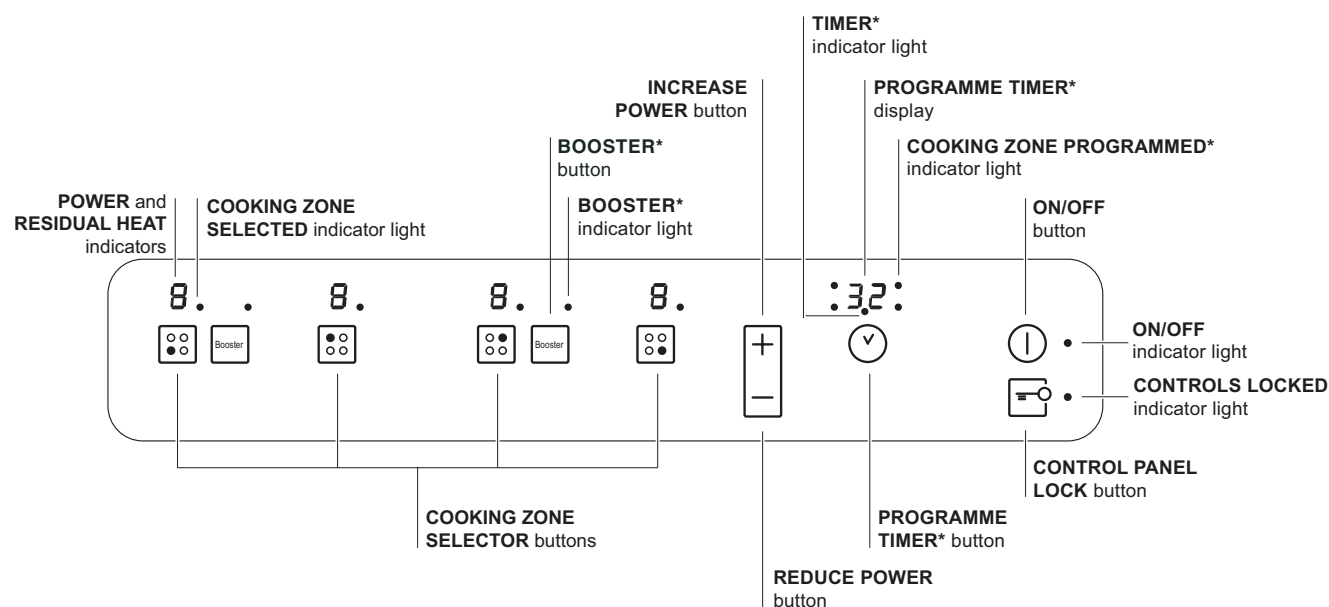

- **INCREASE POWER** button switches on the hotplate and controls the power (see *Start-up and use*).
 - **REDUCE POWER** button controls the power and switches off the hotplate (see *Start-up and use*).
 - **COOKING ZONE SELECTOR** button shows a particular cooking zone has been selected and therefore various adjustments are possible.
 - **COOKING ZONE SELECTOR** button is used to select the desired cooking zone.
 - **POWER** indicator provides a visual display for the current heat level.
 - **ON/OFF** button switches the appliance on and off.
 - **ON/OFF** indicator light shows whether the appliance is on or off.
 - **PROGRAMME TIMER*** button controls the cooking programme times (see *Start-up and use*).
 - **PROGRAMME TIMER*** display shows which programme has been selected (see *Start-up and use*).
 - **COOKING ZONE PROGRAMMED*** indicator lights show which cooking zones are being used during a cooking programme (see *Start-up and use*).
 - **CONTROL PANEL LOCK** button prevents accidental changes to the hob settings (see *Start-up and use*).
 - **CONTROL PANEL LOCK** indicator light shows the control panel has been locked (see *Start-up and use*).
 - **BOOSTER** button* activates the booster function - 3000 W - of the cooking zone (see *Start-up and use*).
 - **BOOSTER** indicator light* shows that the booster function has been activated.
 - **TIMER*** indicator light shows that the timer has been activated
- ! This product complies with the requirements of the latest European Directive on the limitation of power consumption of the standby mode. If no operations are carried out for a period of 2 minutes, after the residual heat indicator lights turn off and the fan stops (if present), the appliance automatically switches to the "off mode". The appliance resumes the operating mode once the ON/OFF button is pressed.

* Only available in certain models.

! The glue applied on the gaskets leaves traces of grease on the glass. Before using the appliance, we recommend you remove these with a special non-abrasive cleaning product. During the first few hours of use there may be a smell of rubber which will disappear very quickly.

! A few seconds after the hob is connected to the electricity supply, a buzzer will sound. The hob may now be switched on.

Types of noise during normal hob operation:

- **Buzz:** due to the vibration of the metallic parts that make up the induction element and the pot; it is generated by the electromagnetic field required for heating and increases as the power of the induction element increases.
- **Soft whistle:** heard when the pot placed on the heating zone is empty; the noise disappears once food or water is placed into the pot.
- **Crackle:** produced by the vibration of materials on the bottom of the pot due to the flow of parasitic currents caused by electromagnetic fields (induction); can be more or less intense depending on the material making up the bottom of the pot, and decreases as the pot dimensions increase.
- **Loud whistle:** heard when two induction elements of the same group function simultaneously at maximum power and/or when the booster function is set on the larger element while the other is auto-adjusted. Noise is reduced by decreasing the power level of the auto-adjusted induction element; pot bottom layers made of different kinds of materials are among the main causes of this noise.
- **Fan noise:** a fan is necessary to ensure the hob functions correctly and to safeguard the electronic unit from possible overheating. The fan functions at maximum power when the large induction element is at maximum power or when the booster function is on; in all other cases, it works at average power depending on the temperature detected. Furthermore, the fan may continue to work even after switching the hob off, if the temperature detected is high.

The types of noise listed above are due to induction technology and are not necessarily operational faults.

! If the **-** or **+** button is pressed for an extended period of time, the display scrolls quickly through the power levels and timer minutes.

* Only available in certain models.

Switching on the hob

To switch the hob on, press and hold the  button for approximately one second.

Switching on the cooking zones

Each cooking zone is controlled using a selector button  and a power adjustment device

consisting of a double **-** and **+** button.

- To begin operating a cooking zone, press the corresponding control button and set the desired power level (between 0 and 9) using the buttons **-** and **+**.

Booster function*

The booster function for some of the cooking zones may be used to shorten heating-up times. It may be activated by pressing the  button. The indicator light directly above the button will illuminate. This function boosts the power to 2000 W or 3000 W, depending on the size of the relevant cooking zone. The booster stops automatically after 4 minutes. While the booster for one of the cooking zones is active, the corresponding front or rear cooking zone will operate at a reduced power level (e.g. if the booster for the rear left-hand hotplate has been activated, the power level of the front left-hand hotplate will be reduced). For further information, please refer to the *Technical description of the models*.

Switching off the cooking zones

To switch off a cooking zone, select it using the corresponding selector button  and:

- Press the **-** button: the power of the cooking zone will progressively decrease until it is switched off.

Programming the cooking duration

! All the cooking zones may be programmed simultaneously, for a duration between 1 and 99 minutes.

1. Select the cooking zone using the corresponding selector button.
2. Adjust the power level of the cooking zone.
3. Press the  button. The indicator light corresponding to the selected zone will start flashing.

4. Set the cooking duration using the **-** and **+** buttons.

5. Confirm by pressing the  button or automatic selection occurs after 10 seconds.



The timer begins counting down immediately. A buzzer sounds for approximately 1 minute and the cooking zone switches off when the set programme has finished. Repeat the above procedure for each hotplate you wish to programme.

Using multiple programmes and the display

If one or more hotplates are programmed, the display will show the data for the hotplate with the least time remaining, and the light corresponding to the position of the hotplate will flash. The lights corresponding to the other hotplates programmed will be switched on. To visualise the time remaining for the other programmed hotplates, press the  button repeatedly: the time remaining for each hotplate will be shown sequentially in a clockwise order, starting from the front left hotplate.



Changing the programme

1. Press the  button repeatedly until the duration you wish to change is shown.
2. Use the  buttons to set the new duration.
3. Confirm by pressing the  button.

To cancel a programme, follow the above instructions.

At step 2, press the **-** button: the duration decreases progressively until it reaches 0 and switches off. The programme resets and the display exits programming mode.

Timer

The hob must be switched on. The timer can be used to set a duration up to 99 minutes.

1. Press the  programming button until the timer

indicator light is illuminated .

2. Set the desired duration using the **-** and **+** buttons.

3. Confirm by pressing the  button.

The timer begins counting down immediately. When the time has elapsed, a buzzer will sound (for one minute).

Control panel lock

When the hob is switched on, it is possible to lock the oven controls in order to avoid accidental changes being made to the settings (by children, during cleaning, etc.). Press the  button to lock the control panel: the indicator light above the button will switch on.

To use any of the controls (e.g. to stop cooking), you must switch off this function. Press the  button for a few moments, the indicator light will switch off and the lock function will be removed.

Switching off the hob

Press the button  to switch off the appliance - do not rely solely on the pan sensor.

If the control panel lock has been activated, the controls will continue to be locked even after the hob is switched on again. In order to switch the hob on again, you must first remove the lock function.

“Demo” mode

It is possible to set the hob to a demonstration mode where all the controls work normally but the heating elements do not switch on. To activate the “demo” mode the hob must be switched on, with all the hotplates switched off.

- Press and hold the **+** and **-** buttons simultaneously for 6 seconds. When the 6 seconds have elapsed, the ON/OFF and CONTROLS LOCKED indicator lights will flash for one second.

Release the **+** and **-** buttons and press the  button;

- The display will show the text DE and MO and the hob will be switched off.
- When the hob is switched on again it will be set to the “demo” mode.

To exit this mode, follow the procedure described above. The display will show the text DE and OF and the hob will be switched off. When it is next switched on, the hob will function normally.

Practical advice on using the appliance

! Use cookware made from materials which are compatible with the induction principle (ferromagnetic material). We especially recommend pans made from: cast iron, coated steel or special stainless steel adapted for induction. Use a magnet to test the compatibility of the cookware.

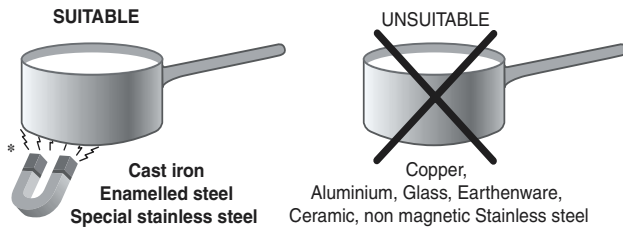

In addition, to obtain the best results from your hob:

- Use pans with a thick, flat base in order to fully utilise the cooking zone.

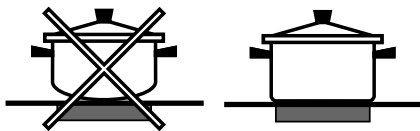

- Always use pans with a diameter which is large enough to cover the hotplate fully, in order to use all the available heat.



- Make sure that the base of the cookware is always clean and dry, in order to fully utilise and extend the life of both the cooking zones and the cookware.
- Avoid using the same cookware which has been used on gas burners: the heat concentration on gas burners may distort the base of the pan, causing it not to adhere correctly.

Safety devices

Pan sensor

Each cooking zone is equipped with a pan sensor device. The hotplate only emits heat when a pan with suitable measurements for the cooking zone is placed on it. If the indicator light is flashing, it may indicate:

- An incompatible pan
- A pan whose diameter is too small
- The pan has been removed from the hotplate.

Overheating protection

If the electronic elements overheat, the hob switches off automatically and **F** appears on the display, followed by a flashing number. When the temperature has reached a suitable level, this message disappears and the hob may be used again.

Safety switch

The appliance has a safety switch which automatically switches the cooking zones off after they have been in operation for a certain amount of time at a particular power level. When the safety switch has been triggered, the display shows "0".

For example: the right rear hotplate is set to 5 and will switch off after 5 hours of continuous operation, while the front left hotplate is set to 2 and will switch off after 8 hours.







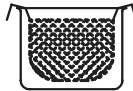

Power level	Maximum operating time in hours
1	9
2	8
3	7
4	6
5	5
6	4
7	3
8	2
9	1

Buzzer

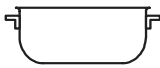
This can also indicate several irregularities:

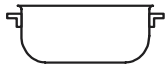
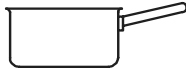
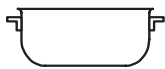
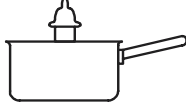
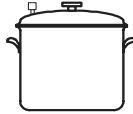
- An object (a pan, cutlery, etc.) has been placed on the control panel for more than 10 seconds.
- Something has been spilt on the control panel.
- A button has been pressed for too long. All of the above situations may cause the buzzer to sound. Remove the cause of the malfunction to stop the buzzer. If the cause of the problem is not removed, the buzzer will keep sounding and the hob will switch off.

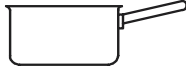
Practical cooking advice

Very high-flame cooking	9	 Pressure cooking Pressure cooker	 Frying
	8	 Grilling	 Boiling
High-flame cooking	7	 Crêpes	 Cooking on a high flame and browning (roasts, steaks, escalopes, fish fillets, fried eggs)
Medium-flame cooking	6	 Fast thickening (liquid juices) Boiling water (pasta, rice, vegetables) Milk	
	5	 Slow thickening (dense juices)	
	4	 Bain-marie cooking	 Pressure cooking after whistle
Low-flame cooking	3	 Low-flame cooking (stews)	 Reheating dishes
Very low-flame cooking	2	 Chocolate sauce	 Keeping food hot

! This appliance has been designed and manufactured in compliance with international safety standards. The following warnings are provided for safety reasons and must be read carefully.

 This appliance conforms to the following European Economic Community directives:

- 2006/95/EEC dated 12/12/06 (Low Voltage) and subsequent amendments;
- 2004/108/EEC dated 15/12/04 (Electromagnetic Compatibility) and subsequent amendments;
- 93/68/EEC dated 22/07/93 and subsequent amendments.
- 1275/2008 stand-by/off mode.

General safety

! Make sure that the air inlet behind the fan grille is never obstructed. The built-in hob should, in fact, be provided with suitable ventilation for the cooling of the electronic components used in the appliance.

! We advise against the installation of an induction hob above an under-the-counter refrigerator (heat) or above a washing machine (vibrations). In fact, there would be insufficient space for the ventilation of electronic components.

- The appliance was designed for domestic use inside the home and is not intended for commercial or industrial use.
- The appliance must not be installed outdoors, even in covered areas. It is extremely dangerous to leave the appliance exposed to rain and storms.
- Do not touch the appliance when barefoot or with wet or damp hands and feet.
- **The appliance must be used by adults only for the preparation of food, in accordance with the instructions outlined in this booklet. Any other use of the appliance (e.g. for heating the room) constitutes improper use and is dangerous. The manufacturer may not be held liable for any damage resulting from improper, incorrect and unreasonable use of the appliance.**
- The glass ceramic hob is resistant to mechanical shocks, but it may crack (or even break) if hit with a sharp object such as a tool. If this happens, disconnect the appliance from the electricity mains immediately and contact a Service Centre.
- Ensure that power supply cables of other electrical appliances do not come into contact with the hot parts of the hob.
- Remember that the cooking zones remain relatively hot for at least thirty minutes after they have been switched off. An indicator light provides a warning when residual heat is present (*see Start-up and use*).
- Keep any object which could melt away from the hob, for example plastic and aluminium objects, or products with a high sugar content. Be especially careful when using plastic film and aluminium foil or packaging: if placed on surfaces which are still hot, they may cause serious damage to the hob.

- Always make sure that pan handles are turned towards the centre of the hob in order to avoid accidental burns.
- When unplugging the appliance, always pull the plug from the mains socket; do not pull on the cable.
- Never perform any cleaning or maintenance work without having disconnected the appliance from the electricity mains.
- The appliance should not be operated by people (including children) with reduced physical, sensory or mental capacities, by inexperienced individuals or by anyone who is not familiar with the product. These individuals should, at the very least, be supervised by someone who assumes responsibility for their safety or receive preliminary instructions relating to the operation of the appliance.

- **For the attention of wearers of pacemakers or other active implants:**

The hob complies with all current standards on electromagnetic interference.

Your induction hob is therefore perfectly in keeping with legal requirements (89/336/CEE directives). It is designed not to create interference on any other electrical apparatus being used on condition that the apparatus in question also complies with this legislation.

Your induction hob generates short-range magnetic fields. To avoid any interference between your induction hob and a pacemaker, the latter must be designed to comply with relevant regulations. In this respect, we can only guarantee our own product conformity. Please consult the pacemaker manufacturer or your doctor concerning its conformity or any possible incompatibility.

- Do not let children play with the appliance.
- Do not place metal objects (knives, spoons, pan lids, etc.) on the hob as they may become hot.
- **The appliance is not intended to be operated by means of an external timer or separate remote-control system.**

Disposal



- When disposing of packaging material: observe local legislation so that the packaging may be reused.
 - The European Directive 2002/96/EC relating to Waste Electrical and Electronic Equipment (WEEE) states that household appliances should not be disposed of using the normal solid urban waste cycle. Exhausted appliances should be collected separately in order to optimise the cost of re-using and recycling the materials inside the machine, while preventing potential damage to the atmosphere and to public health. The crossed-out dustbin is marked on all products to remind the owner of their obligations regarding separated waste collection.
- For further information relating to the correct disposal of exhausted household appliances, owners may contact the public service provided or their local dealer.

Care and maintenance

GB

Switching the appliance off

Disconnect your appliance from the electricity supply before carrying out any work on it.

Cleaning the appliance

! Do not use abrasive or corrosive detergents (for example, products in spray cans for cleaning barbecues and ovens), stain removers, anti-rust products, powder detergents or sponges with abrasive surfaces: these may scratch the surface beyond repair.

! Never use steam cleaners or pressure cleaners on the appliance.

- It is usually sufficient simply to wash the hob using a damp sponge and dry it with absorbent kitchen towel.
- If the hob is particularly dirty, rub it with a special glass ceramic cleaning product, then rinse well and dry thoroughly.
- To remove more stubborn dirt, use a suitable scraper. Remove spills as soon as possible, without waiting for the appliance to cool, to avoid residues forming crusty deposits. You can achieve excellent results by using a rust-proof steel wire sponge - specifically designed for glass ceramic surfaces - soaked in soapy water.
- If any plastic or sugary substances are accidentally melted on the hob, remove them immediately with the scraper, while the surface is still hot.

- Once it is clean, the hob may be treated with a special protective maintenance product: the invisible film left by this product protects the surface from drips during cooking. This maintenance task should be carried out while the appliance is warm (not hot) or cold.
- Always remember to rinse the appliance well with clean water and dry it thoroughly: residues can become encrusted during subsequent cooking processes.

Stainless steel frame (only in models with outer frame)

Stainless steel can be marked by hard water which has been left on the surface for a long time, or by cleaning products containing phosphorus. After cleaning, it is advisable to rinse the surface well and dry it thoroughly. If water is spilt on the surface, dry it quickly and thoroughly.

! Some hobs have an aluminium frame which is similar to stainless steel. Do not use any cleaning or degreasing products which are not suitable for use with aluminium.

Disassembling the hob

If it is necessary to disassemble the hob:

1. Loosen the screws fixing the alignment springs on each side.
2. Loosen the screws holding the fixing hooks in each corner.
3. Take the hob out of its installation cavity.

! Do not attempt to repair the appliance yourself. If the appliance breaks down, contact a Service Centre.

Technical description of the models

The induction system is the quickest existing way of cooking. Unlike traditional hotplates where the cooking zone heats up, with the induction system heat is generated directly inside pans which have ferromagnetic bases.

Hobs	CIC 642 C	CIA 641 C S
Cooking zone	Power (W)	Power (W)
Back Left	I 1400 - 600 if front left*	I 1400
Back Right	I 2200 - B 3000*	I 2200 - B 3000*
Front Left	I 2200 - B 3000*	I 2200
Front Right	I 1400 - 600 if back right*	I 1400 - 600 if back right*
Total power	7200	7200

Key:

I = single induction cooking zone

B = booster: the power level of the cooking zone may be boosted to 3000 W

* = the maximum power level is limited while the booster is activated for the relevant rear cooking zone (see *Start-up and use*).



Guarantee

12 months Parts and Labour Guarantee

Your appliance has the benefit of our manufacturer's guarantee, which covers the cost of breakdown repairs for twelve months from the date of purchase.

This gives you the reassurance that if, within that time, your appliance is proven to be defective because of either workmanship or materials, we will, at our discretion, either repair or replace the appliance at no cost to you.

This guarantee is subject to the following conditions:

- The appliance has been installed and operated correctly and in accordance with our operating and maintenance instructions.
- The appliance is used only on the electricity or gas supply printed on the rating plate.
- The appliance has been used for normal domestic purposes only.
- The appliance has not been altered, serviced, maintained, dismantled, or otherwise interfered with by any person not authorised by us.
- Any repair work must be undertaken by us or our appointed agent.
- Any parts removed during repair work or any appliance that is replaced become our property.
- The appliance is used in the United Kingdom or Republic of Ireland.

The guarantee does not cover:

- Damage resulting from transportation, improper use, neglect or interference or as a result of improper installation.
- Replacement of any consumable item or accessory. These included but not limited to: plugs, cables, batteries, light bulbs, fluorescent tubes and starters, covers and filters.
- Replacement of any removable parts made of glass or plastic.

THIS GUARANTEE WILL NOT APPLY IF THE APPLIANCE HAS BEEN USED IN COMMERCIAL OR NON-DOMESTIC PREMISES.

5 Year Parts Guarantee

Hotpoint also offers you a free 5 year parts guarantee. This additional guarantee is conditional on you registering your appliance with us and the parts being fitted by one of our authorised engineers. There will be a charge for our engineer's time. To activate the extra parts warranty on your appliance, simply call our registration line on **08448 24 24 24 (Republic of Ireland 01 230 0800)**

Extended Guarantees

We offer a selection of protection plans that enable you to fully cover yourself against the expense of repair bills for the life of your policy. To find the ideal plan for you please call our advice line on **08448 226 226 (Republic of Ireland 01 230 0233)**.

Free Helpdesk Service

We have a dedicated team who can provide free advice and assistance with your appliance if you experience any technical difficulties within the first 90 days of ownership. Simply call our Hotpoint Service Hotline on **08448 224 224 (Republic of Ireland 0818 313 413)** for telephone assistance, or, where necessary, to arrange for an engineer to call.



After Sales Service

No one is better placed to care for your Hotpoint appliance during the course of its working life than us – the manufacturer.

Essential Contact Information

Hotpoint Service

We are the largest service team in the country offering you access to 400 skilled telephone advisors and 1000 fully qualified engineers on call to ensure you receive fast, reliable, local service.

UK: 08448 224 224
Republic of Ireland: 0818 313 413
www.hotpointservice.co.uk

Please note: Our advisors will require the following information:

Model number:

Serial number:

Parts and Accessories

We supply a full range of genuine replacement parts as well as accessory products that protect and hygienically clean your appliance to keep it looking good and functioning efficiently throughout its life.

UK: 08448 225 225
Republic of Ireland: 0818 313 413
www.hotpointservice.co.uk

Appliance Registration

We want to give you additional benefits of Hotpoint ownership. To activate your free 5 year parts guarantee you must register your appliance with us.

UK: 08448 24 24 24
Republic of Ireland: 01 230 0800
www.hotpointservice.co.uk

Indesit Company UK Ltd. Morley Way, Peterborough, PE2 9JB
Indesit Company Unit 49 Airways Industrial Estate, Dublin 17

Recycling and Disposal Information

As part of Hotpoint's continued commitment to helping the environment, Hotpoint reserves the right to use quality, recycled components to keep down customer costs and minimise material wastage.

Please dispose of packaging and old appliances carefully. To minimise the risk of injury to children, remove the door, plug, and cut the mains cable off flush with the appliance. Dispose of these parts separately to ensure that the appliance can no longer be plugged into mains socket, and the door cannot be locked shut.

Free Manuals Download Website

<http://myh66.com>

<http://usermanuals.us>

<http://www.somanuals.com>

<http://www.4manuals.cc>

<http://www.manual-lib.com>

<http://www.404manual.com>

<http://www.luxmanual.com>

<http://aubethermostatmanual.com>

Golf course search by state

<http://golfingnear.com>

Email search by domain

<http://emailbydomain.com>

Auto manuals search

<http://auto.somanuals.com>

TV manuals search

<http://tv.somanuals.com>