

GB

English,1

CRA 641 D C

Contents

GB

Installation, 2-4

Positioning
Electrical connection

Description of the appliance, 5-6

Control panel
Extendable cooking zones

Start-up and use, 7-9

Switching on the hob
Switching on the cooking zones
Switching off the cooking zones
Power function
Heating elements
Control panel lock
Switching off the hob
Practical advice on using the appliance
Safety devices
Practical cooking advice

Precautions and tips, 10

General safety
Disposal

Care and maintenance, 11

Switching the appliance off
Cleaning the appliance
Disassembling the hob

Technical description of the models, 12

After Sales Service, 14

Guarantee, 15

Key Contacts, 16

Installation

GB

! Before operating your new appliance please read this instruction booklet carefully. It contains important information concerning the safe operation, installation and maintenance of the appliance.
! Please keep these operating instructions for future reference. Pass them on to any new owners of the appliance.

Positioning

! Keep all packaging material out of the reach of children. It may present a choking or suffocation hazard (see *Precautions and tips*).
! The appliance must be installed by a qualified professional in accordance with the instructions provided. Incorrect installation may cause harm to people and animals or may damage property.

Built-in appliance

Use a suitable cabinet to ensure that the appliance functions properly.

- The supporting surface must be heat-resistant up to a temperature of approximately 100°C.
- If the appliance is to be installed above an oven, the oven must be equipped with a forced ventilation cooling system.
- Avoid installing the hob above a dishwasher: if this cannot be avoided, place a waterproof separation device between the two appliances.
- Depending on the hob you want to install, the cabinet must have the following dimensions (see figure):

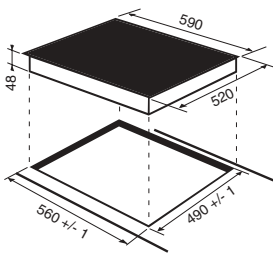

Ventilation

To allow adequate ventilation and to avoid overheating of the surrounding surfaces the hob should be positioned as follows:

- At a minimum distance of 40 mm from the back panel.
- So that a minimum distance of 20 mm is maintained between the installation cavity and the cabinet underneath.
- Kitchen cabinets adjacent to the appliance and taller than the top of the hob must be at least 600 mm from the edge of the hob.

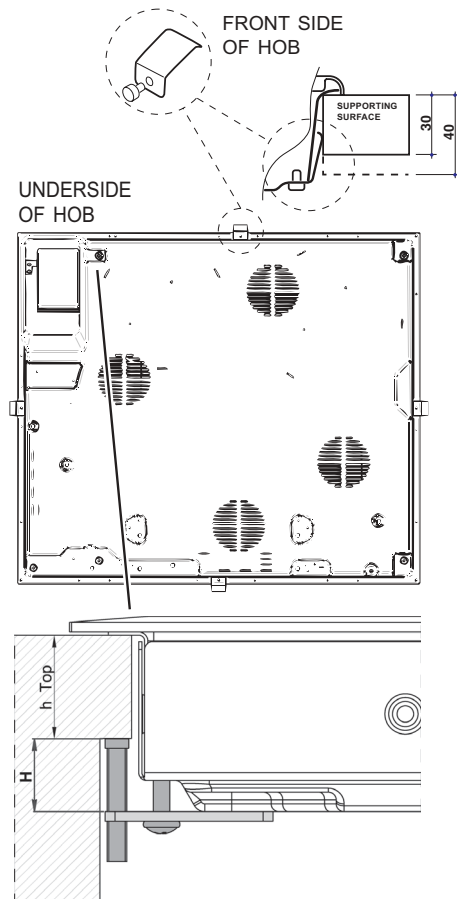
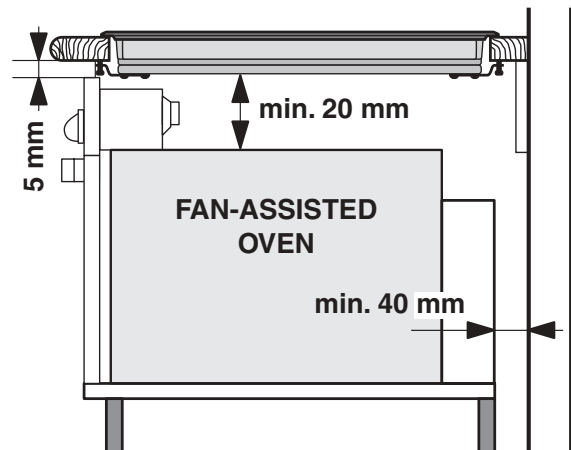
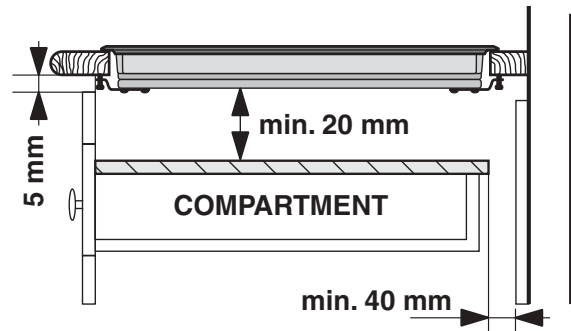

Fixing

The appliance must be installed on a perfectly level supporting surface.

Any deformities caused by improper fixing could affect the features and operation of the hob.

The thickness of the supporting surface should be taken into account when choosing the length of the screws for the fixing hooks:

- 30 mm thick: 17.5 mm screws
- 40 mm thick: 7.5 mm screws

Fix the hob as follows:

1. Use short flat-bottomed screws to fix the 4 alignment springs in the holes provided at the central point of each side of the hob.
2. Place the hob in the cavity, make sure it is in a central position and push down on the whole perimeter until the hob is stuck to the supporting surface.
3. For hobs with raised sides: After inserting the hob into its cavity, insert the 4 fixing hooks (each has its own pin) into the lower edges of the hob, using the long pointed screws to fix them in place, until the glass is stuck to the supporting surface.

! The screws for the alignment springs must remain accessible.

! In order to adhere to safety standards, the appliance must not come into contact with electrical parts once it has been installed.

! All parts which ensure the safe operation of the appliance must not be removable without the aid of a tool.

Electrical connection

! The electrical connection for the hob and for any built-in oven must be carried out separately, both for safety purposes and to make extracting the oven easier.

Terminal board

UNDERSIDE OF HOB

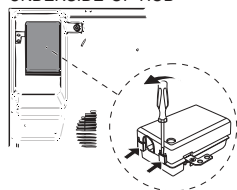

On the lower part of the appliance there is a connection box for the different types of electricity supply (the picture is only an indication and is not an exact representation of the purchased model).

Single-phase connection

The hob is equipped with a pre-connected electricity supply cable, which is designed for single-phase connection. Connect the wires in accordance with the instructions given in the following table and diagrams:

| Voltage and mains frequency | Electrical cable | Wire connection |
|--|------------------|---|
| 230-240V 1+N ~ 220-240V 1+N ~ 50/60 Hz | | ⏏: yellow/green; N: the two blue wires together L: brown and black together |

Other types of connection

If the mains supply corresponds with one of the following:

Voltage and mains frequency

- 400V - 2+N ~ 50/60 Hz
- 220-240V 3 ~ 50/60 Hz
- 230-240V 3 ~ 50/60 Hz
- 400V - 2+2N ~ 50/60 Hz

Separate the wires and connect them in accordance with the instructions given in the following table and diagrams:

| Voltage and mains frequency | Electrical cable | Wire connection |
|---|------------------|--|
| 400V - 2+N ~ 50/60 Hz | | ⏏: yellow/green; N: the two blue wires together L1: black L2: brown |
| 230-240V 3 ~ 220-240V 3 ~ 50/60Hz | | ⏏: yellow/green; N1: blue N2: blue L1: black L2: brown |

If the mains supply corresponds with one of the following:

Voltage and mains frequency

- 400V 3 - N ~ 50/60 Hz

proceed as follows:

! The cable provided is not suitable for the following types of installation.

1. Use a suitable supply cable, H05RR-F or higher, with the right dimensions (cable cross section: 25 mm).
2. To open the terminal board, use a screwdriver as a lever under the side tabs of the cover (*see Terminal board picture*).
3. Loosen the cable clamp screw and the terminal board screws in accordance with the type of

connection required and position the connection supports as shown in the following table and diagrams.

4. Position the wires in accordance with the information given in the following table and diagrams and connect the appliance by tightening all the screws for the springs as much as possible.

| Voltage and mains frequency | Electrical connections | Terminal board |
|-----------------------------|------------------------|-----------------|
| 400V 3-N ~ 50/60 Hz | | Three-phase 400 |

5. Secure the power supply cable by fastening the cable clamp screw, then put the cover back on.

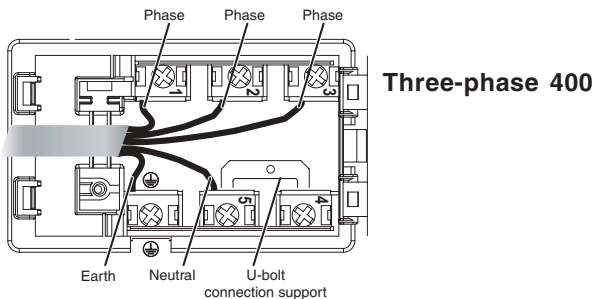

Connecting the electricity supply cable to the mains

If the appliance is being connected directly to the electricity mains an omnipolar switch must be installed with a minimum opening of 3 mm between contacts.

! The installer must ensure that the correct electrical connection has been made and that it is fully compliant with safety regulations.

Before connecting the appliance to the power supply, make sure that:

- The appliance is earthed and the plug is compliant with the law.
- The socket can withstand the maximum power of the appliance, which is indicated on the data plate located on the appliance itself.
- The voltage falls within the range of values indicated on the data plate.
- The socket is compatible with the plug of the appliance. If the socket is incompatible with the plug, ask an authorised technician to replace it. Do not use extension cords or multiple sockets.

! Once the appliance has been installed, the power supply cable and the electrical socket must be easily accessible.

! The cable must not be bent or compressed.

! The cable must be checked regularly and replaced by authorised technicians only.

! The manufacturer declines any liability should these safety measures not be observed.

! Do not remove or replace the power supply cable for any reason. Its removal or replacement will void the warranty and the CE marking. INDESIT does not assume liability for accidents or damage arising from replacement/removal of the original power supply cable. Replacement can only be accepted when carried out by personnel authorised by INDESIT and using an original spare part.

Description of the appliance

Control panel

The control panel described in this manual is only a representative example: it may not exactly match the panel on your appliance.

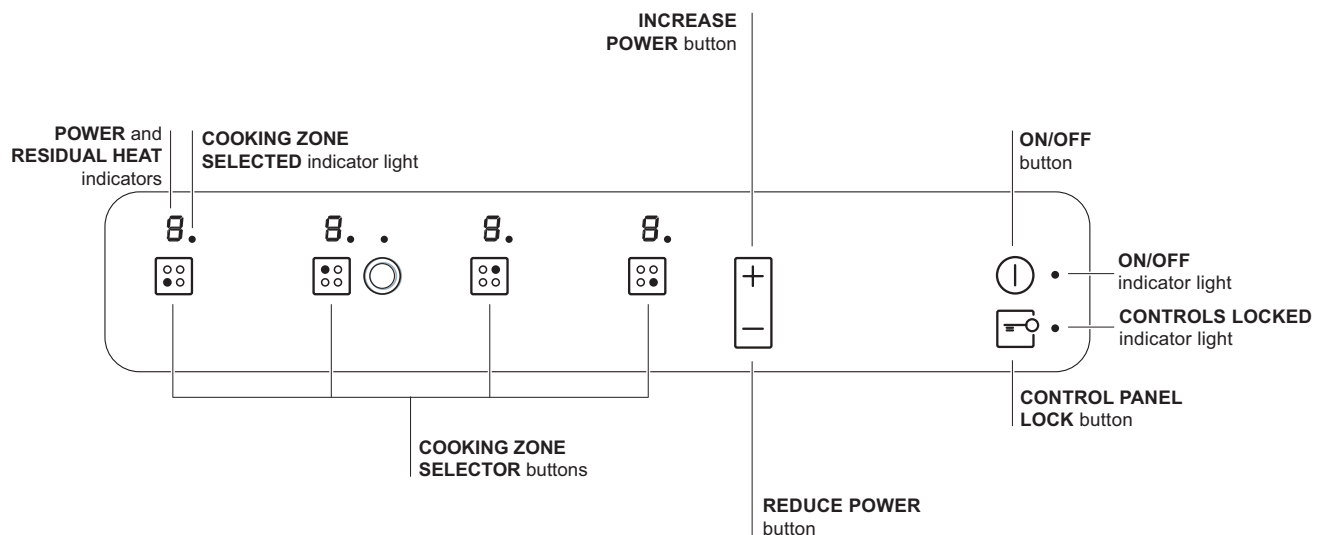

- **INCREASE POWER** button switches on the hotplate and controls the power (*see Start-up and use*).
- **REDUCE POWER** button controls the power and switches off the hotplate (*see Start-up and use*).
- **COOKING ZONE SELECTOR** button shows a particular cooking zone has been selected and therefore various adjustments are possible.
- **COOKING ZONE SELECTOR** button is used to select the desired cooking zone.
- **POWER** indicator provides a visual display for the current heat level.
- **ON/OFF** button switches the appliance on and off.
- **ON/OFF** indicator light shows whether the appliance is on or off.
- **CONTROL PANEL LOCK** button prevents accidental changes to the hob settings (*see Start-up and use*).
- **CONTROL PANEL LOCK** indicator light shows the control panel has been locked (*see Start-up and use*).

Extendable cooking zones

Certain models are fitted with extendable cooking zones. These may be circular or oval and may vary in their extensibility (they may be double or triple hotplates). A list of controls is given below (these controls are only present in models with the extendable cooking zone option).

Circular extendable hotplate

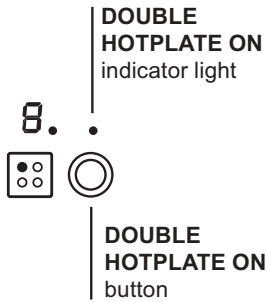

- **DOUBLE HOTPLATE ON** button switches on the double hotplate (*see Start-up and use*).
- **DOUBLE HOTPLATE ON** indicator light shows the double hotplate has been switched on.

! The glue applied on the gaskets leaves traces of grease on the glass. Before using the appliance, we recommend you remove these with a special non-abrasive cleaning product. During the first few hours of use there may be a smell of rubber which will disappear very quickly.

! A few seconds after the hob is connected to the electricity supply, a buzzer will sound. The hob may now be switched on.

! If the **-** or **+** button is pressed for an extended period of time, the display scrolls quickly through the power levels and timer minutes.

Switching on the hob

To switch the hob on, press and hold the  button for approximately one second.



Switching on the cooking zones

Each cooking zone is controlled using a selector button  and a power adjustment device

consisting of a double **-** and **+** button.

- To begin operating a cooking zone, press the corresponding control button and set the desired power level (between 0 and 9) using the buttons **-** and **+**.

Power function

The power function for the cooking zones may be used to shorten heating-up times. Activate and set the power level for the desired cooking zone  as described in the previous paragraph. Press and hold the selector button corresponding to the desired cooking zone  for at least 2 seconds. The display, the power level indicator, will alternately show the letter "P" and the power level set previously until the desired power level has been reached. Once this level has been reached, the display will revert to showing the set power level. To deactivate this function, press and hold **-** for at least 2 seconds - the selector button corresponding to the cooking zone on which the  function has been activated; alternatively, select a different power level using the buttons **-** and **+**.

Switching off the cooking zones

To switch off a cooking zone, select it using the corresponding selector button  and:

- Press the **-** button: the power of the cooking zone will progressively decrease until it is switched off.

Heating elements

Two types of heating element may be installed, depending on the appliance model: halogen and radiant elements.

Halogen elements emit heat via radiation from the halogen lamps they contain.

They have similar properties to gas burners: they are easy to control and reach set temperatures quickly, allowing you to see the power level instantly.

Radiant elements consist of a series of coils which allow heat to be distributed evenly at the base of the cookware, so that all slow-flame cooking may be performed successfully, for example stews, sauces or reheated dishes.

Control panel lock

When the hob is switched on, it is possible to lock the oven controls in order to avoid accidental changes being made to the settings (by children, during cleaning, etc.). Press the  button to lock the control panel: the indicator light above the button will switch on.

To use any of the controls (e.g. to stop cooking), you must switch off this function. Press the  button for a few moments, the indicator light will switch off and the lock function will be removed.

Switching off the hob

Press the  button to switch the appliance off. If the control panel lock has been activated, the controls will continue to be locked even after the hob is switched on again. In order to switch the hob on again, you must first remove the lock function.

Practical advice on using the appliance

To obtain the best results from your hob:

- Use pans with a thick, flat base in order to fully utilise the cooking zone.

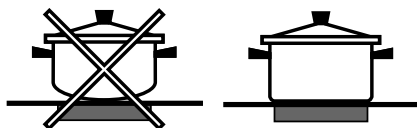

- Always use pans with a diameter which is large enough to cover the hotplate fully, in order to use all the available heat.



- Make sure that the base of the cookware is always clean and dry, in order to fully utilise and extend the life of both the cooking zones and the cookware.
- Avoid using the same cookware which has been used on gas burners: the heat concentration on gas burners may distort the base of the pan, causing it not to adhere correctly.

Safety devices

Pan sensor

Each cooking zone is equipped with a pan sensor device. The hotplate only emits heat when a pan with suitable measurements for the cooking zone is placed on it. If the indicator light is flashing, it may indicate:

- An incompatible pan
- A pan whose diameter is too small
- The pan has been removed from the hotplate.

Residual heat indicators

Each cooking zone is equipped with a residual heat indicator. This indicator signals which cooking zones are still at a high temperature. If the power display

shows **H**, the cooking zone is still hot. It is possible, for example, to keep a dish warm or melt butter or chocolate. As the cooking zone cools, the power display will show **h**. The display switches off when the cooking zone has cooled sufficiently.

Overheating protection

If the electronic elements overheat, the hob switches off automatically and **F** appears on the display, followed by a flashing number. When the temperature has reached a suitable level, this message disappears and the hob may be used again.

Safety switch

The appliance has a safety switch which automatically switches the cooking zones off after they have been in operation for a certain amount of time at a particular power level. When the safety switch has been triggered, the display shows "0". For example: the right rear hotplate is set to 5 and will switch off after 5 hours of continuous operation, while the front left hotplate is set to 2 and will switch off after 8 hours.

| Power level | Maximum operating time in hours |
|-------------|---------------------------------|
| 1 | 9 |
| 2 | 8 |
| 3 | 7 |
| 4 | 6 |
| 5 | 5 |
| 6 | 4 |
| 7 | 3 |
| 8 | 2 |
| 9 | 1 |











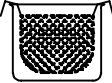

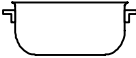
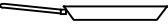
Buzzer

This can also indicate several irregularities:

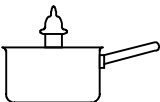
- An object (a pan, cutlery, etc.) has been placed on the control panel for more than 10 seconds.
- Something has been spilt on the control panel.
- A button has been pressed for too long. All of the above situations may cause the buzzer to sound. Remove the cause of the malfunction to stop the buzzer. If the cause of the problem is not removed, the buzzer will keep sounding and the hob will switch off.

Practical cooking advice

GB

| | | | |
|-------------------------|---|---|---|
| Very high-flame cooking | 9 |  Pressure cooking Pressure cooker |  Frying |
| | 8 |  Grilling |  Boiling |
| High-flame cooking | 7 |  Crêpes |  Cooking on a high flame and browning (roasts, steaks, escalopes, fish fillets, fried eggs) |
| Medium-flame cooking | 6 |  Fast thickening (liquid juices) Boiling water (pasta, rice, vegetables) Milk |  |
| | 5 |  Slow thickening (dense juices) |  |
| | 4 |  Bain-marie cooking |  Pressure cooking after whistle |
| Low-flame cooking | 3 |  Low-flame cooking (stews) |  Reheating dishes |
| Very low-flame cooking | 2 |  Chocolate sauce |  Keeping food hot |

Precautions and tips

GB

! This appliance has been designed and manufactured in compliance with international safety standards. The following warnings are provided for safety reasons and must be read carefully.

CE This appliance conforms to the following European Economic Community directives:
- 2006/95/EEC dated 12/12/06 (Low Voltage) and subsequent amendments;
- 89/336/EEC dated 03/05/89 (Electromagnetic Compatibility) and subsequent amendments;
- 93/68/EEC dated 22/07/93 and subsequent amendments.

General safety

! Make sure that the air inlet behind the fan grille is never obstructed. The built-in hob should, in fact, be provided with suitable ventilation for the cooling of the electronic components used in the appliance.

- The appliance was designed for domestic use inside the home and is not intended for commercial or industrial use.
- The appliance must not be installed outdoors, even in covered areas. It is extremely dangerous to leave the appliance exposed to rain and storms.
- Do not touch the appliance when barefoot or with wet or damp hands and feet.
- The appliance must be used by adults only for the preparation of food, in accordance with the instructions provided in this booklet. Do not use the hob as a worktop or chopping board.
- The glass ceramic hob is resistant to mechanical shocks, but it may crack (or even break) if hit with a sharp object such as a tool. If this happens, disconnect the appliance from the electricity mains immediately and contact a Service Centre.
- Ensure that power supply cables of other electrical appliances do not come into contact with the hot parts of the hob.
- Remember that the cooking zones remain relatively hot for at least thirty minutes after they have been switched off. An indicator light provides a warning when residual heat is present (*see Start-up and use*).
- Keep any object which could melt away from the hob, for example plastic and aluminium objects, or products with a high sugar content. Be especially careful when using plastic film and aluminium foil or packaging: if placed on surfaces which are still hot, they may cause serious damage to the hob.

- Always make sure that pan handles are turned towards the centre of the hob in order to avoid accidental burns.
- When unplugging the appliance, always pull the plug from the mains socket; do not pull on the cable.
- Never perform any cleaning or maintenance work without having disconnected the appliance from the electricity mains.
- The appliance should not be operated by people (including children) with reduced physical, sensory or mental capacities, by inexperienced individuals or by anyone who is not familiar with the product. These individuals should, at the very least, be supervised by someone who assumes responsibility for their safety or receive preliminary instructions relating to the operation of the appliance.
- Do not look at the halogen lamps in the cooking zones for long if they are present.
- Do not let children play with the appliance.

Disposal



- When disposing of packaging material: observe local legislation so that the packaging may be reused.
- The European Directive 2002/96/EC relating to Waste Electrical and Electronic Equipment (WEEE) states that household appliances should not be disposed of using the normal solid urban waste cycle. Exhausted appliances should be collected separately in order to optimise the cost of re-using and recycling the materials inside the machine, while preventing potential damage to the atmosphere and to public health. The crossed-out dustbin is marked on all products to remind the owner of their obligations regarding separated waste collection. For further information relating to the correct disposal of exhausted household appliances, owners may contact the public service provided or their local dealer.

Switching the appliance off

Disconnect your appliance from the electricity supply before carrying out any work on it.

Cleaning the appliance

! Do not use abrasive or corrosive detergents (for example, products in spray cans for cleaning barbecues and ovens), stain removers, anti-rust products, powder detergents or sponges with abrasive surfaces: these may scratch the surface beyond repair.

! Never use steam cleaners or pressure cleaners on the appliance.

- It is usually sufficient simply to wash the hob using a damp sponge and dry it with absorbent kitchen towel.
- If the hob is particularly dirty, rub it with a special glass ceramic cleaning product, then rinse well and dry thoroughly.
- To remove more stubborn dirt, use a suitable scraper. Remove spills as soon as possible, without waiting for the appliance to cool, to avoid residues forming crusty deposits. You can achieve excellent results by using a rust-proof steel wire sponge - specifically designed for glass ceramic surfaces - soaked in soapy water.
- If any plastic or sugary substances are accidentally melted on the hob, remove them immediately with the scraper, while the surface is still hot.
- Once it is clean, the hob may be treated with a special protective maintenance product: the invisible film left by this product protects the surface from drips during cooking. This maintenance task should be carried out while the appliance is warm (not hot) or cold.
- Always remember to rinse the appliance well with clean water and dry it thoroughly: residues can become encrusted during subsequent cooking processes.

Stainless steel frame (only in models with outer frame)

Stainless steel can be marked by hard water which has been left on the surface for a long time, or by cleaning products containing phosphorus. After cleaning, it is advisable to rinse the surface well and dry it thoroughly. If water is spilt on the surface, dry it quickly and thoroughly.

! Some hobs have an aluminium frame which is similar to stainless steel. Do not use any cleaning or degreasing products which are not suitable for use with aluminium.

Disassembling the hob

If it is necessary to disassemble the hob:

1. Loosen the screws fixing the alignment springs on each side.
2. Loosen the screws holding the fixing hooks in each corner.
3. Take the hob out of its installation cavity.

! Do not attempt to repair the appliance yourself. If the appliance breaks down, contact a Service Centre.

Technical description of the models

GB

This table provides a model-by-model list of the energy absorption values, type of heating elements and diameters of each cooking zone.

| Hobs | CRA 641 D C | |
|---------------------|--------------------|----------------------|
| Cooking zone | Power (W) | Diameter (mm) |
| Back Left | DH 2200/1000 | 210/140 |
| Back Right | H 1400 | 160 |
| Front Left | H 1200 | 145 |
| Front Right | H 1800 | 180 |
| Total power | 6600 | |

Key:

H = single hilight

DH = double hilight

After Sales Service

"No company is better positioned to offer an after sales service on a Hotpoint appliance than us - the manufacturer"

As part of our commitment to you, all Hotpoint appliances have the added benefit of a fully inclusive parts and labour guarantee for the first 12 months. In addition to this you also have the advantage of free replacement parts for the first 5 years when fitted by a Hotpoint engineer. When the 12 months parts and labour guarantee expires we offer the following after sales service options:

Repair Service and Information Help Desk

UK: 08709 066066

www.theservicecentre.co.uk

Republic of Ireland: 1850 302 200

Note: Our operators will require the Model number and the Serial number of your appliance

Available 364 days a year with a fast, effective and value for money service. We have the largest white goods repair service in the UK with over 1200 of our own fully trained engineers. All repairs include a parts and labour guarantee for 12 months from the date of the repair.

If you require any information or have any questions about your appliance, our operators are on hand with help and advice.

All this ensures that you will receive the best available after sales service possible.

Extended Warranties

UK: 08709 088 088

www.theservicecentre.co.uk

Republic of Ireland: 1850 502 200

Whether you have just one or a number of Hotpoint appliances in your kitchen, we offer two service cover plans to give you total peace of mind.

- Repair Protection Plan - FREE service repairs for a single Hotpoint appliance during the period of cover.
- Kitchen Cover - FREE service repairs for all your Hotpoint appliances less than 8 years old.

Genuine Parts and Accessories UK: 08709 077 077

www.theservicecentre.co.uk

Republic of Ireland: (01) 842 6836

A wide range of genuine parts and accessories are available from our hotline or through our web site.

Genuine parts and accessories, extended warranties and service repairs are all available on our web-site at:



www.theservicecentre.co.uk

Guarantee

"Satisfaction guaranteed or your money back"

We give you a unique 'satisfaction guaranteed' promise - valid for 90 days - after you have purchased your Hotpoint appliance. If there is a technical problem simply call Hotpoint Repair service or visit our web-site at www.theservicecentre.co.uk and where necessary, we will arrange for an engineer to call. If the technical problem is not resolved under this guarantee, we will replace your machine or, if you prefer, give you your money back.

All Hotpoint appliances carry a fully inclusive 12 month parts and labour guarantee as well as free replacement parts for the first 5 years (except microwaves, selected integrated appliances and cooker hoods, which have a one year guarantee) provided that they are fitted by a Hotpoint engineer.

Guarantee terms and conditions

Your guarantee is only applicable in the United Kingdom or Republic of Ireland and is subject to the following provisions that your appliance:

- Has been installed and used correctly in accordance with this instruction booklet.
- Has been used solely for domestic purposes and is located on domestic premises (ie. not for commercial or trade use).
- Has been properly connected to a suitable electrical supply voltage as stated on the appliance rating plate.
- Has not been subject to misuse, accident, modified or repaired by anyone other than one of our own service engineers.



For pre purchase information on any other Hotpoint product call: 08701 50 60 70
or visit: www.hotpoint.co.uk



Recycling & Disposal Information

As part of Hotpoint's continued commitment to helping the environment, Hotpoint reserves the right to use quality recycled components to keep down customer costs and minimise material wastage.

Please dispose of packaging and old appliances carefully.

To minimise risk of injury to children, remove the door, plug and cut mains cable off flush with the appliance. Dispose of these parts separately to ensure that the appliance can no longer be plugged into a mains socket, and the door cannot be locked shut.

Key Contacts

After Sales Service

Over 1200 trained specialists, directly employed by us, ensure that you can have complete confidence in both the appliances and services we offer.



Repair Service and Information Desk

UK: 08709 066 066

(Open 8 to 8 Mon - Fri, 8 to 6 Sat, 10 to 4 Sun & Bank Holidays)

www.theservicecentre.co.uk

Republic of Ireland: 1850 302 200

Note: Our operators will require the following information:

Model number:

Serial number:

Extended Warranties

UK: 08709 088 088

(Open 8 to 8 Mon - Sun)

www.theservicecentre.co.uk

Republic of Ireland: 1850 502 200

Genuine Parts and Accessories

UK: 08709 077 077

(Open 8-30 to 5-30 Mon - Fri & 9 to 12 Sat)

www.theservicecentre.co.uk

Republic of Ireland: (01) 842 6836

Indesit Company UK Ltd. Morley Way, Peterborough, PE2 9JB.

Free Manuals Download Website

<http://myh66.com>

<http://usermanuals.us>

<http://www.somanuals.com>

<http://www.4manuals.cc>

<http://www.manual-lib.com>

<http://www.404manual.com>

<http://www.luxmanual.com>

<http://aubethermostatmanual.com>

Golf course search by state

<http://golfingnear.com>

Email search by domain

<http://emailbydomain.com>

Auto manuals search

<http://auto.somanuals.com>

TV manuals search

<http://tv.somanuals.com>