



Instructions for Installation and Use

Electric Hob
Models: E7134-E6005

To the Installer

Before installation fill in the product details on the back cover of this book.
The information can be found on the rating plate.

To the User

You must read the instructions prior to installing and using the appliance and
then retain them for future reference.

CONTENTS

| | |
|----------------------------|------------|
| Introduction | 3 |
| Advice and recommendations | 4 |
| Installation and fastening | 5 |
| Electrical Connection | 6 |
| Cooking zone description | 7 |
| The controls | 8 |
| Operation | 9 |
| The safety devices | 10 |
| Maintenance and care | 11 |
| After Sales Service | 12 |
| Hotpoint Guarantee | 13 |
| Key Contacts | Back Cover |

Retention of this Instruction Book

This Instruction Book must be kept handy for reference as it contains important details on the safe and proper use of the appliance.

If you sell or pass the appliance to someone else, or move house and leave it behind, make sure this Book is also provided so the new owner can become familiar with the appliance and safety warnings.

If the Book is lost or damaged a copy may be obtained from:
Merloni Elettrodomestici LTD, Morley Way, Peterborough, PE2 9JB

Introduction

Your new hob is guaranteed* and will give lasting service. This guarantee is only applicable if the appliance has been installed in accordance with the installation instructions detailed in this booklet.

To help make best use of your cooking equipment, please read this booklet carefully.

The hob is designed specifically for domestic use and responsibility will not be accepted for use in any other installation.

*** The guarantee is subject to the provisions that the appliance:**

- (a) Has been used solely in accordance with this booklet.**
- (b) Has been properly connected to a suitable supply voltage as stated on the rating plate, attached to the appliance.**
- (c) Has not been subjected to misuse or accident or been modified or repaired by any person other than the manufacturers authorised employee or agent.**
- (d) Has been correctly installed.**



This appliance conforms with the following European Economic Community directives:

- 73/23/EEC of 19/02/73 (Low Voltage) and subsequent modifications;
- 89/336/EEC of 03/05/89 (Electromagnetic Compatibility) and subsequent modifications;
- 90/396/EEC of 29/06/90 (Gas) and subsequent modifications;
- 93/68/EEC of 22/07/93 and subsequent modifications.

Advice and recommendations

- **This appliance was designed for non-professional, household use.**
- Before using the appliance, read the instructions in the owner's manual carefully since it contains all the instructions you require to ensure safe installation, use and maintenance. Keep this owner's manual in a safe place for future reference.
- When you have removed the packing, check whether the appliance is intact. If you have any doubts, contact a qualified professional before using the appliance.
- *Never leave the packing components (plastic bags, polystyrene foam, nails, etc.) within the reach of children since these are a source of potential danger.*
- The appliance must be installed by a qualified technician in compliance with the instructions provided by the manufacturer.
- *The latter denies all responsibility for improper installation which may harm persons and animals and damage property.*
- The electrical safety of this appliance can only be guaranteed if the latter is correctly and efficiently earthed, in compliance with regulations on electrical safety. Always ensure that this vital safety measure has been taken. If you have any doubts, call in a qualified technician to check the electrical system thoroughly.
- *The manufacturer denies all responsibility for damage resulting from a system which has not been earthed correctly.*
- Before powering the appliance, check whether the technical characteristics featured on the appliance data plate correspond with those of the mains electrical system.
- Check that the current load of the mains supply and of the power sockets is suitable for the maximum power of the appliance, indicated on the appliance data plate. If in doubt, contact a qualified professional.
- This appliance must only be used for the purpose for which it was expressly designed. Any other use (such as heating a room for example) is considered to be improper and consequently dangerous.
- *The manufacturer denies all responsibility for damage resulting from improper or incorrect use of the appliance.*
- Certain fundamental rules must be followed when using electrical appliances. The following are of particular importance:
 - do not touch the appliance with wet or damp hands,
 - never use the appliance when barefoot,
 - never use extensions,
 - never pull on the power supply cable or the appliance itself to unplug it from the mains socket,
 - never leave the appliance exposed to atmospheric agents (rain, sun, etc.),
 - do not allow children or persons who are not familiar with the appliance to use it without supervision.
- Always unplug the appliance from the mains or switch off the main switch before cleaning or performing any cleaning or maintenance operations.
- **If the surface of the glass cracks, unplug the appliance immediately.** For any repairs, contact only an authorised after-sales service centre and demand original spare parts. Failure to comply with the above may compromise the safety of the appliance.
- Cut the power supply cable after disconnecting it from the power mains when you decide not to use the appliance any longer. Also make all potentially dangerous parts of the appliance safe, above all for children who could play with the appliance.
- **The glass ceramic hob is resistant to thermal and mechanical shocks. However, it may break due to a shock caused by a sharp object, such as a tool for example. In this case, unplug the appliance immediately and contact an authorised after-sales service centre to have it repaired.**
- Remember that the heating area stays hot for at least half an hour after being turned off; please refrain from placing any cookware or other items on the cooking zone while still hot.
- Do not turn on the heating zones if aluminium foil or plastic items have been placed on the hob surface.
- Do not go near the heating zones when these are still hot.
- If you use small electric appliances near the hob, make sure their power supply cable does not come into contact with the hot parts of the hob.
- Make sure all pan handles are always pointing inwards towards the centre of the hob to prevent any accidental spills.

First use: the glue used on the hob seals may leave greasy traces on the glass surface. We recommend you wipe these off before using the appliance, with the aid of a non abrasive cleaner. During the first few hours of use, you may detect a smell of rubber, which will disappear quickly.

Installation and fastening

The following instructions are intended for a qualified fitter to guide him/her along the installation, adjustment and technical maintenance procedures as correctly as possible and in full compliance with the applicable norms in force. **Important**: unplug the hob before all operations.

Installation

- This hob can be built into a worktop simply by cutting out the corresponding slot.
- The worktop must be made with a material designed to withstand a temperature of approximately 100°C.
- The hob should be positioned at least 40 mm away from the back wall or any other vertical surface in order to allow for correct ventilation and to prevent the surfaces around the appliance from overheating.
- If you wish to install the hob on top of an oven, the latter must be fitted with a cooling fan.
- Try to avoid installing the hob on top of a dishwasher; if this is unavoidable, place a watertight separating element between the two appliances.

Fastening

Very important: It is vital that you ensure the glass ceramic hob is built into a perfectly flat supporting surface. *Deformations due to improper fastening could alter the characteristics of the hob and compromise its performance.*

The fastening springs are fastened by screws (see diagram).

It is vital that these screws be kept accessible at all times.

Insert the hob into the cut-out slot, applying pressure all along the perimeter of the hob frame so that the latter adheres fully to the worktop.

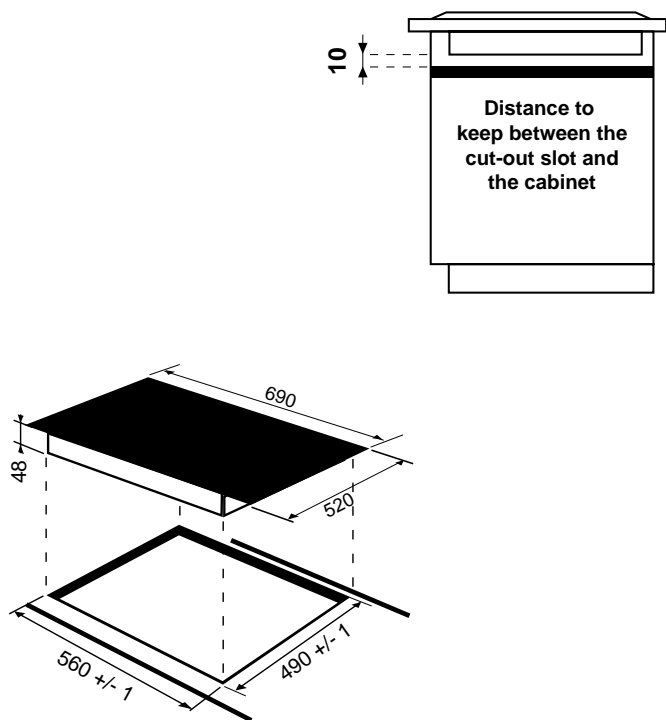

REAR SPRING ASSEMBLY

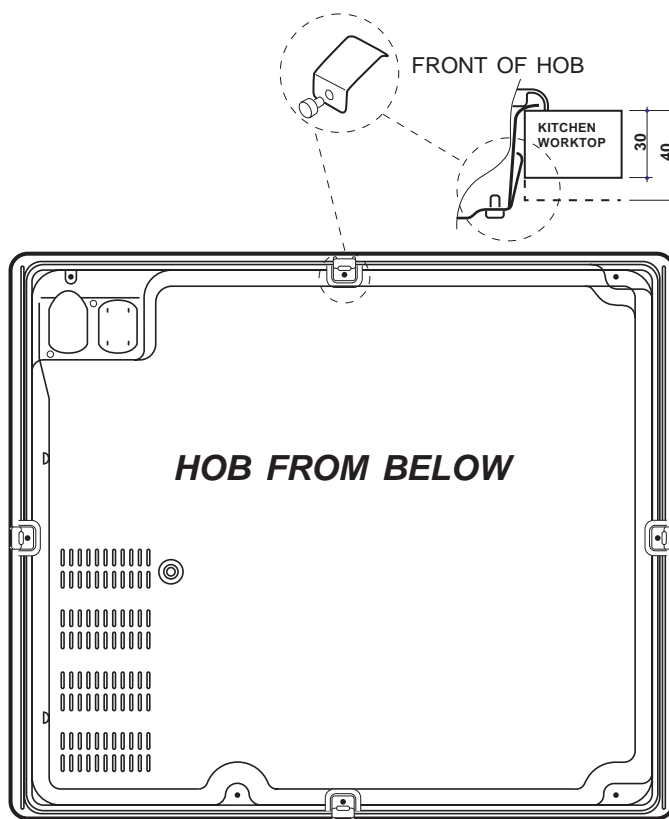

Technical characteristics

Electrical connection

- The electrical safety of this appliance can only be guaranteed if the latter is correctly and efficiently earthed, in compliance with regulations on electrical safety. Always ensure that this vital safety measure has been taken. If you have any doubts, call in a qualified technician to check the electrical system thoroughly.
- *The manufacturer denies all responsibility for damage resulting from a system which has not been earthed correctly.*
- Before powering the appliance, check whether the technical characteristics featured on the appliance data plate correspond with those of the mains electrical system.
- Check that the current load of the mains supply and of the power sockets is suitable for the maximum power of the appliance, indicated on the appliance data plate. If in doubt, contact a qualified professional.

Disconnect the appliance from the electricity supply before all operations.

Connect your hob to the electrical system by means of a **junction box**: if the appliance is connected permanently to the mains, an **omnipolar circuit breaker**, accessible if necessary, with a minimum contact opening of 3 mm should be installed.

Valid only for models with a power supply cable for three-phase connections

Some models are supplied with a three-phase power supply cable, and should consequently only be connected to the three-phase mains. Observe the wire colours, as indicated in the diagram attached.

Some models are not fitted with a power supply cable, as the cable should be sized according to the type of electrical connection in use (see connection table below). To connect the cable, proceed as follows:

- Using a screwdriver, prise on the side tabs of the terminal board cover;
- Pull open the cover of the terminal board.

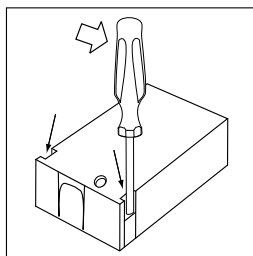

To install the cable, proceed as follows:

- unscrew the wire clamp screw and the contact screws.
- to make the desired electrical connection (see table), use the jumpers housed inside the box. Position the power supply cable wires according to the indications in the table.
- once the connections have been made, tighten all the terminal screws fully.
- Fasten the supply cable in place with the clamp and close the cover of the terminal board.

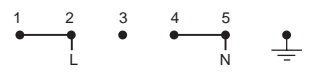
| Electrical connections | Voltage, Frequency | Fuses, Sections |
|--|--------------------|------------------------------|
|  | 230V-1+N~50 Hz | 25 A* 2,5 mm ² |
| <i>* Application of the simultaneity coefficient in accordance with cei 60335-2-6 norm</i> | | |



This appliance conforms with the following European Community Directives:

- 73/23/EEC of 19/02/73 (Low Voltage) and subsequent amendments;
- 89/336/EEC of 03/05/89 (Electromagnetic compatibility) and subsequent amendments;
- 93/68/EEC of 22/07/93 and subsequent amendments;

Warning: If the hob is fitted above a built-in oven, the hob and the oven must be connected to the mains separately for safety reasons and to simplify operations when it is necessary to pull the oven out for some reason.

Cooking zone description

Radiant zones

This type of burner consists of several coils that guarantee the even distribution of heat over the bottom of the pan and ensure the success of all cooking on low heat: simmering, sauces or reheating.

| HOBS | ET7134 | | ET6004 | |
|---------------|---|------------------|------------------|------------------|
| Cooking zones | Power (in W) | Diameter (in mm) | Diameter (in mm) | Diameter (in mm) |
| Back left | RD 1000/2300 | 230 | 2300 | 210 |
| Front left | R 1400 | 160 | 1200 | 140 |
| Back right | RO 1100/2000 | 210 | 1400 | 160 |
| Front right | R 600 | 100 | 1800 | 180 |
| Overall power | 6300 | | 6700 | |
| | H = halogen, R = simple radiant, RO = oval radiant, RD = dual radiant, | | | |

The table below features information on how to use the zones to their full potential.

| Power | Type of dish |
|-------|-------------------------------------|
| 1 | Melted butter or chocolate |
| 2 | Reheating liquids |
| 3 | |
| 4 | Preparation of creams and sauces |
| 5 | Cooking stews, blanquette, desserts |
| 6 | Cooking pasta and rice |
| 7 | Sealing meat, fish, omelettes |
| 8 | |
| 9 | Fried food |

Each zone is controlled:

- by a selector key whose silk screen printing reproduces the cooking zone drawing,
- and by a power adjustment set comprising two parts (+,-).

A specific key controls the extension of the zones (concentric or oval).

As long as the temperature of the cooking zones remains above 60°C, even after use, **the residual heat indicators stay on** (the power indicator displays H) to prevent the risk of burns.

The controls

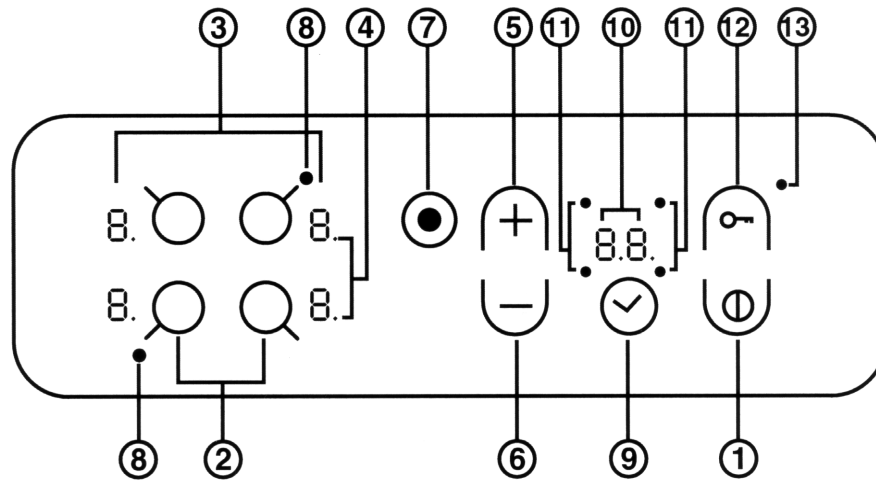

1. ON/OFF key
2. Cooking zone selector keys
3. Power (from 0 to 9) and residual heat indicators (H)
4. Zone selection indicator:
 - on: the corresponding zone is selected and can be modified,
 - off: the corresponding zone is not selected, no modification can be made.
5. Power increase key
6. Power decrease key
7. Extendable cooking zone(s) (concentric or oval) extension key: featured by hobs fitted with 1 or 2 extendable zones
8. The maximum zone on indicator light for the extendable zones (concentric or oval): fitted beside each extendable cooking zone
9. Timer control key for cooking time programming (only on hobs fitted with a timer)
10. Programmed cooking time indicator
11. Indicator light corresponding to the programmed cooking zone
12. Controls lock key
13. Lock indicator light

Note

- The extendable zone(s) extension key (7) and the relative indicator lights (8) are only fitted on hobs featuring extendable cooking zones (concentric or oval).
- The timer control key (9), the cooking time indicator (10) and zone indicator lights (11) are only fitted on hobs featuring a timer.

Operation

When you connect the hob to the power supply, a beep will sound after a few seconds: you can now turn the hob on.

Turning on the hob

Press key  for 3 seconds to turn the hob on.

Cooking zone control

Each cooking zone is operated by a control key and by a power adjustment set (+ and -).

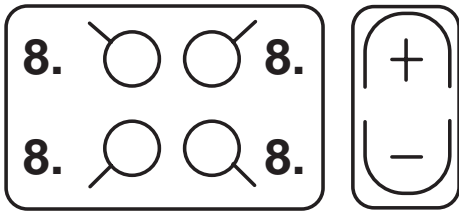

Turning on a cooking zone

- To turn a cooking zone on, press the corresponding control key and set the desired heating power (from 0 to 9) using the “+” and “-” keys.
- To set the maximum power directly (9), press key “-” briefly.
- To speed up the rise in temperature on a particular cooking zone, proceed as follows:
 1. set the cooking zone power to the maximum setting (9),
 2. then press the “+” key: the power display will indicate “A”,
 3. now set the power you wish to cook with (for example 5).

When this temperature is reached, the rapid rise in temperature stops automatically and your cooking continues normally at power setting 5.

Extendable cooking zone operation

(if your hob is fitted with extendable zones, see previous page)

1. Press the control key corresponding to the cooking zone,
2. Set the desired heating power (from 0 to 9) using the “+” and “-” keys,
3. Press the  key to set the zone to the maximum power setting.

To go back to the smaller zone, just press the extension key again.

The indicator light situated beside the extendable zone is on when the large cooking zone is in use.

Turning off a cooking zone

To turn off a cooking zone, press the corresponding control key and:

- press both “+” and “-” simultaneously: the cooking zone power drops immediately to zero and the zone is turned off.
- or press the “-” key: the heating power drops progressively until the zone eventually turns off.

Turning off the hob

Press the  key; the appliance has been turned off.

If you have locked the hob controls (see paragraph below), the same will still be locked when you turn the hob back on. Unlock the controls in order to operate the cooking zones.

Controls lock

When the hob is in use, you can lock the controls to avoid any accidental changes to the settings (by children or when cleaning, for example).



Just press the  key, the indicator light next to the key lights up and **the controls are locked**.

To change the power level setting or stop cooking, the controls have to be unlocked: press the  key, the indicator light turns off and **the controls are unlocked**.

To access the setting of a cooking zone again, select the zone by pressing the corresponding control key.

Cooking time programming

A cooking zone can be programmed to cook from 1 minute to a maximum of 99 minutes. Proceed as follows:

- select the cooking zone by pressing the corresponding control key,
- set the desired heating power using the “+” and “-” keys,
- press the programming key ,
- set the desired cooking time using the “+” and “-” keys,
- confirm the programming by pressing the  key again.

The countdown begins immediately.

The end of programmed cooking is signalled by a beep (one minute long) and the cooking zone is turned off.

The safety devices

Acoustic signal

Anomalies such as:

- an object (such as a saucepan or a lid, etc.) placed for more than 10 seconds on the control zone,
- boiled-over liquids or food spilled on the control zone,
- prolonged pressure on a key,...

could cause a beep to sound and the hob to turn off.

To stop the beep from sounding, remove the cause of the malfunction.

To use the hob, turn it back on and re-select the cooking zone(s) you wish to use. Set the desired heating power.

Safety cut out

Your appliance is fitted with a safety cut out which intervenes after a certain amount of time (see table) depending on the power setting. When the safety cut out has intervened, the power display indicates "0".

for example: the back right cooking zone is set to 5 and the front left zone is set to 2. The back right zone will turn off after 4 hours of operation and the front left zone will turn off after 6 hours of operation.

To unlock the controls, turn the hob off by pressing the

ⓘ key.

| Power level | Maximum operating time in hours |
|-------------|---------------------------------|
| 1-2 | 6 |
| 3-4 | 5 |
| 5 | 4 |
| 6-7-8 | 1,5 |
| 9 | 1,5 |

Overheating

Prolonged use of the hob could cause the electronic components to overheat.

A thermal protection device momentarily sets a reduced power (setting 3) on the front cooking zones until the temperature has dropped back down to a suitable level.

Advice on using your appliance

To get the best from your hob, it is vital that you follow a few fundamental rules during cooking and when preparing food.

- Use pans with a flat bottom so they adhere fully to the heating zone.

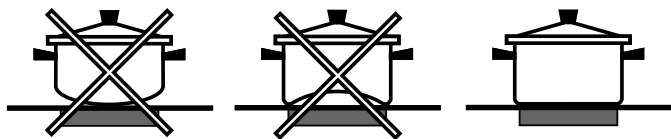

- Always use pans whose diameter covers the cooking zone fully so that all the available heat can be used.



- Make sure the pan base is always clean and dry, to guarantee good contact and long life for the cooking zones and pans alike.
- Avoid using pans used normally on gas burners. The concentration of heat on gas burners can warp the bottom of the pan, consequently you would never obtain the desired result when using the pan on the glass ceramic hob.
- Never leave a cooking zone on without a pan on it as the maximum heat level would be reached very quickly, which could damage the heating elements.
- The glass ceramic hob is resistant to thermal and mechanical shocks. However, it may break due to a shock caused by a sharp object. In this case, **unplug the appliance immediately** and contact an authorised after-sales service centre to have it repaired.

Always keep your hob clean. Before proceeding with maintenance operations, check that all the cooking zones are turned off and have cooled down completely.

Stainless steel frame (only on some models)

Stainless steel can stain as an effect of enduring contact with limescale in water or as an effect of highly aggressive detergents (containing phosphorus). We recommend you rinse and dry it thoroughly after maintenance. It is preferable to remove any water spills immediately.

Hob care

The vitroceramic glass used for the heating surface is smooth and poreless and it is also resistant to thermal shocks and to mechanical shocks under normal conditions of use. In order to preserve these properties, we recommend you care for your hob as follows:

- for ordinary maintenance, just wipe it with a damp sponge and dry it thoroughly using paper towels.
- If the hob is dirty, rub clean using a special cleaner suitable for vitroceramic glass, rinse off and dry thoroughly.
- food residue and dirt can be removed using a special scraper. Do this as soon as possible, do not wait for the hob to cool down in order to avoid incrustations. For excellent results, use a special stainless steel wool pad for vitroceramic glass cleaning soaked in soapy water.
- When the hob is clean, you can apply a special product for the care and protection of the same: this type of product leaves an invisible film on the surface of the hob to protect the same against any spills and boiled-over food. It is best if you do this when the hob is lukewarm or cold.
- Make sure you always rinse the hob with clean water and dry it thoroughly: otherwise the cleaning products could become encrusted onto the hob during subsequent cooking.

Recommendations

- **Never use abrasive or corrosive substances, such as** aerosol cleaners for grills and ovens, stain removers or rust removers, scouring powders and abrasive sponges: even the delicate ones could scratch the hob surface irreversibly.
- We recommend you **keep** all items which could melt **away from the hob**, such as **plastic utensils, sugar or products with a high sugar content**. Should liquid boil over onto the hob surface, **remove** it immediately (while the hob is still hot) using a razor blade scraper, in order to avoid damaging the surface.
- **Use this hob exclusively for cooking.** Do not place items on the hob when the same is not in use. Do not use the hob as a work surface (by placing lids, saucepans or dishcloths on it, for example), nor as a chopping board.
- Never leave aluminium wrappers, aluminium foil and plastic cookware on the hob when hot or still warm.
- Do not use steam cleaners or high pressure cleaners to clean your appliance.



After Sales Service

"No company is better positioned to offer an after sales service on a Hotpoint appliance than us - the manufacturer"

As part of our commitment to you, all Hotpoint appliances have the added benefit of a fully inclusive parts and labour guarantee for the first 12 months. In addition to this you also have the advantage of **free replacement parts for the first 5 years** when fitted by a Hotpoint engineer. When the 12 months parts and labour guarantee expires we offer the following after sales service options:

Repair Service and Information Help Desk

UK: 08709 066066

www.hotpointservice.co.uk

Republic of Ireland: 1850 302 200

Note: Our operators will require the Model number and the Serial number of your appliance

Available 364 days a year with a fast, effective and value for money service. We have the largest white goods repair service in the UK with over 1000 of our own fully trained engineers. All repairs include a parts and labour guarantee for 12 months from the date of the repair.

If you require any information or have any questions about your appliance, our operators are on hand with help and advice.

All this ensures that you will receive the best available after sales service possible.

Extended Warranties

UK: 08709 088 088

www.hotpointservice.co.uk

Republic of Ireland: 1850 502 200

Whether you have just one or a number of Hotpoint appliances in your kitchen, we offer two service cover plans to give you total peace of mind.

- Repair Protection Plan - FREE service repairs for a single Hotpoint appliance during the period of cover.
- Kitchen Cover - FREE service repairs for all your Hotpoint appliances less than 8 years old.

Genuine Parts and Accessories UK: 08709 077 077

www.hotpointservice.co.uk

Republic of Ireland: (01) 842 6836

A wide range of genuine parts and accessories are available from our hotline or through our web site.

Genuine parts and accessories, extended warranties and service repairs are all available on our web-site at:

www.hotpointservice.co.uk





Guarantee

"Satisfaction guaranteed or your money back"

We give you a unique 'satisfaction guaranteed' promise - **valid for 90 days** - after you have purchased your Hotpoint appliance. If there is a technical problem simply call Hotpoint Repair service or visit our web-site at www.hotpointservice.co.uk and where necessary, we will arrange for an engineer to call. If the technical problem is not resolved under this guarantee, **we will replace your machine or, if you prefer, give you your money back.**

All Hotpoint appliances carry a fully inclusive 12 month parts and labour guarantee as well as free replacement parts for the first 5 years provided that they are fitted by a Hotpoint engineer.

Guarantee terms and conditions

Your guarantee is only applicable in the United Kingdom or Republic of Ireland and is subject to the following provisions that your appliance:

- Has been installed and used correctly in accordance with this instruction booklet.
- Has been used solely for domestic purposes and is located on domestic premises (ie. not for commercial or trade use).
- Has been properly connected to a suitable electrical supply voltage as stated on the appliance rating plate.
- Has not been subject to misuse, accident, modified or repaired by anyone other than one of our own service engineers.

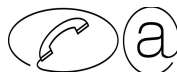

For pre purchase information on any other Hotpoint product call: 08701 50 60 70
or visit: www.hotpoint.co.uk

Recycling & Disposal Information

As part of Hotpoint's continued commitment to helping the environment, Hotpoint reserves the right to use quality recycled components to keep down customer costs and minimise material wastage.

Please dispose of packaging and old appliances carefully.

To minimise risk of injury to children, remove the door, plug and cut mains cable off flush with the appliance. Dispose of these parts separately to ensure that the appliance can no longer be plugged into a mains socket, and the door cannot be locked shut.



Key Contacts

After Sales Service

Over 1200 trained specialists, directly employed by us, ensure that you can have complete confidence in both the appliances and services we offer.

Repair Service and Information Desk

UK: 08709 066 066

(Open 8 to 8 Mon - Fri, 8:30 to 5:30 Sat, 10 to 4 Sun & Bank Holidays)

www.hotpointservice.co.uk

Republic of Ireland: 1850 302 200

Note: Our operators will require the following information:

Model number:

Serial number:

Extended Warranties

UK: 08709 088 088

(Open 8 to 8 Mon - Sun)

www.theservicecentre.co.uk

Republic of Ireland: 1850 502 200

Genuine Parts and Accessories

UK: 08709 077 077

(Open 8-30 to 5-30 Mon - Fri & 9 to 12 Sat)

www.theservicecentre.co.uk

Republic of Ireland: (01) 842 6836

Merloni Elettrodomestici UK Ltd, Morley Way, Peterborough, PE2 9JB.

Free Manuals Download Website

<http://myh66.com>

<http://usermanuals.us>

<http://www.somanuals.com>

<http://www.4manuals.cc>

<http://www.manual-lib.com>

<http://www.404manual.com>

<http://www.luxmanual.com>

<http://aubethermostatmanual.com>

Golf course search by state

<http://golfingnear.com>

Email search by domain

<http://emailbydomain.com>

Auto manuals search

<http://auto.somanuals.com>

TV manuals search

<http://tv.somanuals.com>