

 **Hotpoint**

Creda

collection

kitchen think

Instructions for Installation and Use

**Electric Hobs
Models EC6005**

The Recipe Book

Hotpoint has come up with a small recipe book - which is practical, full of helpful tips and easy to use - to help you rediscover the delights of cooking.

It contains a wide variety of handy tips to keep in mind to try out new dishes effortlessly.

It also has 15 recipes preprogrammed into the oven, so thanks to the interactive display, once you have done the preparation all you have to do is make one simple selection.

To the Installer

Before installation fill in the product details on the back cover this book.

The information can be found on the rating plate.

To the User

You must read the instructions prior to installing and using the appliance and then retain them for future reference.

CONTENTS

Introduction	3
Advice and recommendations	4
Installation and fastening	5
Electrical connection	6
Description of the cooktop and cooking zone	7
The controls	8
The different function of the hob	9
Safetz devices	10
Maintenance and care	11
After Sales Service	14
Hotpoint Guarantee	15
Key Contacts	Back Cover

Retention of this Instruction Book

This Instruction Book must be kept handy for reference as it contains important details on the safe and proper use of the appliance.

If you sell or pass the appliance to someone else, or move house and leave it behind, make sure this Book is also provided so the new owner can become familiar with the appliance and safety warnings.

If the Book is lost or damaged a copy may be obtained from:
Merloni Elettrodomestici LTD, Morley Way, Peterborough, PE2 9JB

Introduction

Your new hob is guaranteed* and will give lasting service. This guarantee is only applicable if the appliance has been installed in accordance with the installation instructions detailed in this booklet.

To help make best use of your cooking equipment, please read this booklet carefully.

The hob is designed specifically for domestic use and responsibility will not be accepted for use in any other installation.

*** The guarantee is subject to the provisions that the appliance:**

- (a) Has been used solely in accordance with this booklet.**
- (b) Has been properly connected to a suitable supply voltage as stated on the rating plate, attached to the appliance.**
- (c) Has not been subjected to misuse or accident or been modified or repaired by any person other than the manufacturers authorised employee or agent.**
- (d) Has been correctly installed.**



This appliance conforms with the following European Economic Community directives:

- 73/23/EEC of 19/02/73 (Low Voltage) and subsequent modifications;
- 89/336/EEC of 03/05/89 (Electromagnetic Compatibility) and subsequent modifications;
- 90/396/EEC of 29/06/90 (Gas) and subsequent modifications;
- 93/68/EEC of 22/07/93 and subsequent modifications.

Advice and recommendations

- **This appliance was designed for non-professional, household use.**
- Before using the appliance, read the instructions in the owner's manual carefully since it contains all the instructions you require to ensure safe installation, use and maintenance. Keep this owner's manual in a safe place for future reference.
- When you have removed the packing, check whether the appliance is intact. If you have any doubts, contact a qualified professional before using the appliance.
- *Never leave the packing components (plastic bags, polystyrene foam, nails, etc.) within the reach of children since these are a source of potential danger.*
- The appliance must be installed by a qualified technician in compliance with the instructions provided by the manufacturer.
- *The latter denies all responsibility for improper installation which may harm persons and animals and damage property.*
- The electrical safety of this appliance can only be guaranteed if the latter is correctly and efficiently earthed, in compliance with regulations on electrical safety. Always ensure that this vital safety measure has been taken. If you have any doubts, call in a qualified technician to check the electrical system thoroughly.
- *The manufacturer denies all responsibility for damage resulting from a system which has not been earthed correctly.*
- Before powering the appliance, check whether the technical characteristics featured on the appliance data plate correspond with those of the mains electrical system.
- Check that the current load of the mains supply and of the power sockets is suitable for the maximum power of the appliance, indicated on the appliance data plate. If in doubt, contact a qualified professional.
- This appliance must only be used for the purpose for which it was expressly designed. Any other use (such as heating a room for example) is considered to be improper and consequently dangerous.
- *The manufacturer denies all responsibility for damage resulting from improper or incorrect use of the appliance.*
- Certain fundamental rules must be followed when using electrical appliances. The following are of particular importance:
 - do not touch the appliance with wet or damp hands,
 - never use the appliance when barefoot,
 - never use extensions,
 - never pull on the power supply cable or the appliance itself to unplug it from the mains socket,
 - never leave the appliance exposed to atmospheric agents (rain, sun, etc.),
 - do not allow children or persons who are not familiar with the appliance to use it without supervision.
- Always unplug the appliance from the mains or switch off the main switch before cleaning or performing any cleaning or maintenance operations.
- **If the surface of the glass cracks, unplug the appliance immediately.** For any repairs, contact only an authorised after-sales service centre and demand original spare parts. Failure to comply with the above may compromise the safety of the appliance.
- Cut the power supply cable after disconnecting it from the power mains when you decide not to use the appliance any longer. Also make all potentially dangerous parts of the appliance safe, above all for children who could play with the appliance.
- The glass ceramic hob is resistant to thermal and mechanical shocks. **However, it may break due to a shock caused by a sharp object, such as a tool for example. In this case, unplug the appliance immediately and contact an authorised after-sales service centre to have it repaired.**
- Remember that the heating area stays hot for at least half an hour after being turned off; please refrain from placing any cookware or other items on the cooking zone while still hot.
- Do not turn on the heating zones if aluminium foil or plastic items have been placed on the hob surface.
- Do not go near the heating zones when these are still hot.
- If you use small electric appliances near the hob, make sure their power supply cable does not come into contact with the hot parts of the hob.
- Make sure all pan handles are always pointing inwards towards the centre of the hob to prevent any accidental spills.

First use: the glue used on the hob seals may leave greasy traces on the glass surface. We recommend you wipe these off before using the appliance, with the aid of a non abrasive cleaner. During the first few hours of use, you may detect a smell of rubber, which will disappear quickly.

Installation and fastening

The following instructions are provided for qualified installers so that they may accomplish installation, adjustment and technical maintenance operations correctly and in compliance with current regulations and standards.

Important: before any operation, disconnect the hob from the electrical supply.

Installation

- The hob should be installed on a piece of kitchen furniture simply by removing the corresponding space.
- The material used for the working surface must be able to resist a temperature of approximately 100°C
- The hob must be positioned at a minimum distance of 40mm from the back wall or from any other vertical surface, to allow for adequate aeration and to prevent the surfaces surrounding the appliance from overheating.
- If you want to install the hob on top of an oven, the latter must come with a forced ventilation cooling system.
- Try to avoid installing the hob on a dishwasher; if you have to do this, place a waterproof separating element between the two appliances.

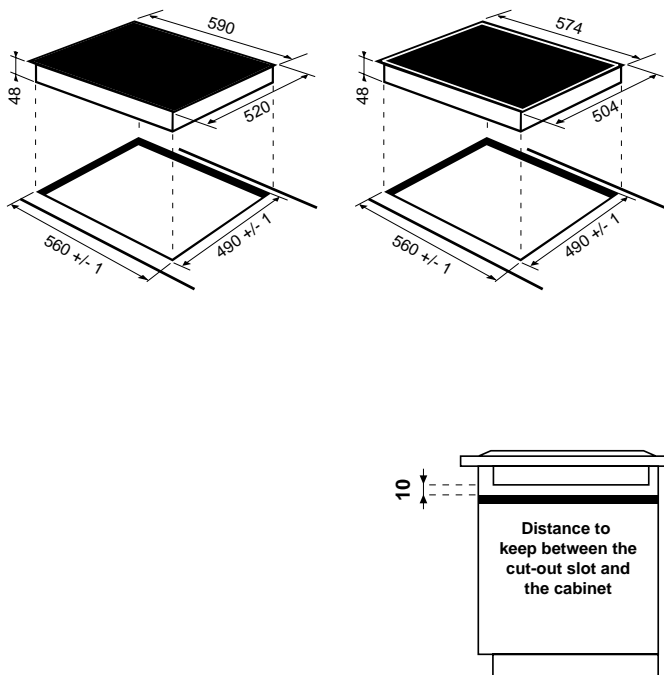

Fastening

Very important: The installation of a glass ceramic hob must be carried out on a perfectly-level supporting surface. *Any deformations caused by incorrect fastening could alter the characteristics and performance of the hob.*

The fastening springs are screwed on with screws (see diagram).

It is essential that these screws are always accessible.

Insert the hob in the space provided in furniture unit, exercising suitable pressure on the entire perimeter so that the hob sticks perfectly to the top.

REAR SPRING ASSEMBLY

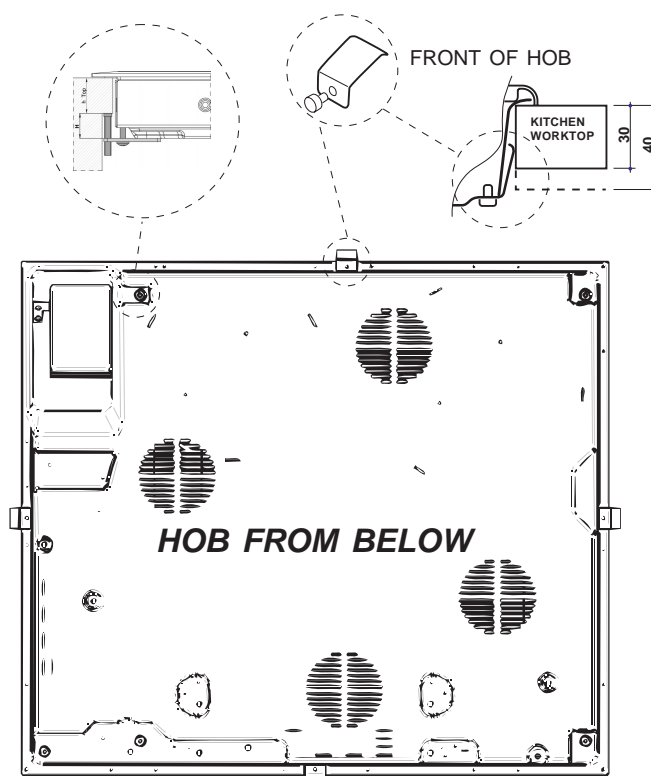

The length of the adjusting screw of the fastening hooks must be set before they are assembled, in accordance to the thickness of the top and to the following table:

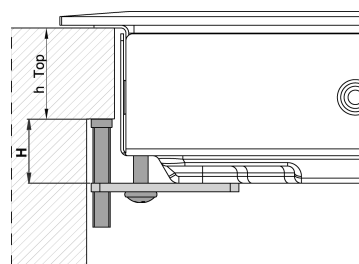

H	
h Top = 30mm	h Top = 40mm
17,5 mm	7,5 mm

Electrical connection

- The electrical safety of this appliance can only be guaranteed if the latter is correctly and efficiently earthed, in compliance with regulations on electrical safety. Always ensure that this vital safety measure has been taken. If you have any doubts, call in a qualified technician to check the electrical system thoroughly.
- The manufacturer denies all responsibility for damage resulting from a system which has not been earthed correctly.*
- Before powering the appliance, check whether the technical characteristics featured on the appliance data plate correspond with those of the mains electrical system.
- Check that the current load of the mains supply and of the power sockets is suitable for the maximum power of the appliance, indicated on the appliance data plate. If in doubt, contact a qualified professional.

Disconnect the appliance from the electricity supply before all operations.

You may connect your hob to the electrical system in two different ways:

- by means of a **junction box**: if the appliance is connected permanently to the mains, an **omnipolar circuit breaker**, accessible if necessary, with a minimum contact opening of 3 mm should be installed.
- by means of a socket conforming to the regulations in force in the country where the appliance is fitted. It should be accessible whenever necessary; do not use adaptors, multiple plugs or extensions.

Important

After connecting the appliance to the flexible cable, tighten all the screws on the terminal board. Make sure jumpers are installed according to the type of mains system as indicated in the table.

For example: line 1 in the table

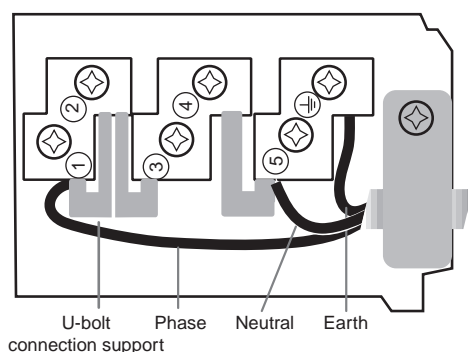

Electrical connections	Voltage Frequency	Fuses Sections
	230V-1+N~50 Hz	25 A* 2.5 mm ²
* Application of the simultaneity coefficient in accordance with IEC 60335-2-6 norm		

In the event of an incorrect connection:

- if your appliance does not work,
- check the position of the wires in the terminal board,
- check that all screws are tight,
- check the positioning of the jumpers.



This appliance conforms with the following European Community Directives:

- 73/23/EEC of 19/02/73 (Low Voltage) and subsequent amendments;
- 89/336/EEC of 03/05/89 (Electromagnetic compatibility) and subsequent amendments;
- 93/68/EEC of 22/07/93 and subsequent amendments;

Warning: If the hob is fitted above a built-in oven, the hob and the oven must be connected to the mains separately for safety reasons and to simplify operations when it is necessary to pull the oven out for some reason.

Description of cooking zones

Halogen elements

This type of element transmits heat through the radiation of the halogen lamp which it contains. It is held in high regard because of its properties which are similar to the typical characteristics of gas: rapid response to commands, instant display of power.

The radiant elements

This type of element is made up of many coils which guarantee the uniform distribution of heat on the bottom of the pot, to ensure perfect cooking on low heat: stews, sauces or dishes that require reheating.

HOBS	EC 6005	
Cooking zones	Power (W)	Diameter (mm)
Back Right	R 1400	180
Front Right	R 1800	200
Back Left	R 1100/2500	250
Front Left	R 600	120
Centre		
Right		
Total power	6300	
	R = radiant	

The following table provides useful indications on how to use the various cooking zones in the best way possible.

Power	Type of cooking
1	Melted butter or chocolate
2-3	Heating liquids
4	Preparation of creams and sauces
5	Boiling meats, cooking blanquettes, desserts
6	Cooking pasta and rice
7-8-9	Cooking meats, fish, omelettes
10-11	Frying

Each cooking zone is activated by a power adjustment device which is made up of a double key (+,-).

The extension of the cooking zones (concentric or oval) is activated by means of key provided.

As long as the temperature of the cooking zones remains above 60°C, even after they have been switched off, **the residual heat indicators, which are located near the relative cooking zone, remain on** to prevent you from getting burnt.

The controls

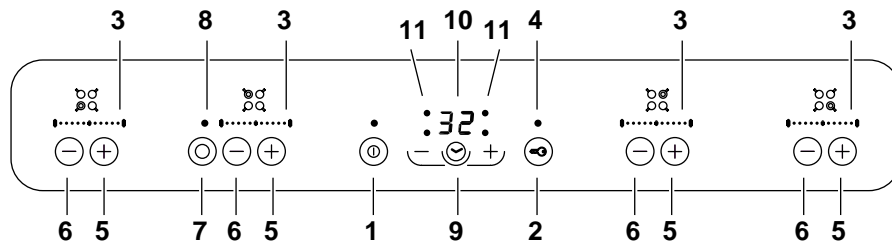

1. On/ off key
2. Control lock key
3. Power indicators
4. Lock indicator light
5. Power increase key
6. Power decrease key
7. Extension key for the extendable cooking zone/s (concentric or oval): found on hobs where there are 1 or 2 extendable cooking zones
8. Surface operation indicator light for the extendable cooking zone/s (concentric or oval): found beside each extendable cooking zone
9. Timer- adjustment key to programme the cooking time
10. Programmed duration indicator
11. Programmed cooking zone indicator light

Note

- The extension key for the extendable cooking zone/s (7) and the relative indicator lights (8) are only found on models that have extendable cooking zones (concentric or oval).

The different function of the hob

When the hob is plugged in, all the indicator lights on the control panel light up for a few moments and there will be a short acoustic signal. Subsequently, the control panel switches off and, at this point, it will be possible to switch the hob on.

Switching the hob on

To switch on the hob, hold the  button down for approximately 1 second.

Cooking zone operation

Each cooking zone is activated by means of a power adjustment device which is made up of a double key (+,-).

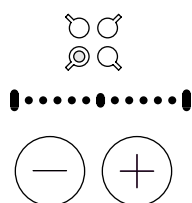

Switching on a cooking zone

- To switch on a cooking zone, set the desired power using the “+” and “-” keys.
- To set the maximum temperature directly, briefly press the “-” key.

Extendable cooking zone operation

(if the hob comes with extendable cooking zones, see previous page)

Double plate;

- a. set the desired power using the “+” and “-” keys (the innermost cooking zone is activated).
- b. press  to enable/disable the outermost cooking area

Switching off a cooking zone

To switch off a cooking zone:

- press the keys “+” and “-” simultaneously: the power immediately returns to 0 and the cooking zone switches off;
- or press the “-” key: the cooking zone’s power decreases progressively until it switches off.

Switching off the hob

Press ; the appliance switches off.

If the hob’s controls have been locked (see previous paragraph), they will continue to be locked even after the hob has been switched back on. To switch the hob back on, it is necessary to unlock the controls.

Locking the controls





When the hob is operating, it is possible to block the controls to prevent the settings from being accidentally modified (children, cleaning operations, etc.).

All you have to do is press ; the indicator light above the key lights up and **the controls are locked**.

To modify the heating power or to interrupt the cooking process, it is necessary to unlock the controls: press  for a few moments; the indicator light goes off and **the controls unlock**.

Programming the cooking time

It is possible to programme all the cooking zones for a duration of between 1 and 99 minutes. Proceed as follows:

- set the desired power on the plate/s using the “+” and “-” keys;
- press the programming key  until the indicator light in the position corresponding to the plate that you intend to programme lights up;
- set the desired cooking time using the “+” and “-” keys    ;
- to confirm the programme
 - a. press  again
 - b. wait approximately 10 seconds without pressing any other keys.

The cooking time countdown begins immediately.

The end of the programmed cooking time is indicated by means of an acoustic signal (this lasts for 10 seconds) and the cooking zone switches off.

Repeat the above-mentioned procedure for each plate that you intend to programme.

Programmed time display

If one or more plates have been programmed, the display shows the time remaining for the plate which is closest to the end of the programmed time, indicating its position by means of the corresponding indicator light, which will be on. The indicator lights that correspond to the other programmed plates will flash.

To show the time remaining for the other programmed plates, press  repeatedly; the times of all the programmed plates will be shown in sequence, in an anti-clockwise direction, beginning from the front left one (only the corresponding indicator light will be on and the display flashes)



Modification of programmed times

Proceed as per the paragraph “Programmed time display” until the time of the plate you intend to modify is shown.

Press the keys “+” and “-”    to set the new time.

Confirm by pressing  or wait 10 seconds without pressing any keys.

Cancelling a programme

Display the time of the plate concerned (as in the paragraph “Programmed time display”) and press the keys “+” and “-”    simultaneously; the programme is re-set and you exit the programming mode.

Safety devices

Acoustic signal

Some anomalies, such as:

- an object (pot, utensil, etc.) placed on the control area for more than 10 seconds,
- a spillage on the control panel,
- sustained pressure on one of the keys, etc.

may cause the acoustic signal to go off.

Remove the cause of the malfunction to stop the acoustic signal. The hob remains locked; all you have to do is unlock it to continue using it (the settings are saved). If the cause of the malfunction is not eliminated, the acoustic signal will carry on, while the hob will switch off for safety reasons.

Safety switch

The appliance comes with an automatic safety switch which goes off after a certain time interval (see table) in accordance with the selected power. During the safety interruption, the letters "Ti" and "ME" alternate on the display.

for example: the right rear cooking zone is set on 5 and the front left cooking zone is set on 2. The right rear zone will switch off after 5 hours of operation, while the left front zone will switch off after 6 hours of operation.

Power level	Operating time limit in hours
1	10
2	6
3-4-5	5
6	4
7-8	3
9-10	2
11	1

Inactivity

If the plate is switched on but is not used for approximately 2 minutes, the control lock function will be enabled. If the same status remains for approximately another 4 minutes, the plate will switch off automatically.

Overheating

Prolonged use of the hob may cause the electrical components to overheat.

A thermal protection device temporarily induces reduced power (3) on the front cooking zones until the temperature has come down to an acceptable level.

Advice on using your appliance

To get the best from your hob, it is vital that you follow a few fundamental rules during cooking and when preparing food.

- Use pans with a flat bottom so they adhere fully to the heating zone.

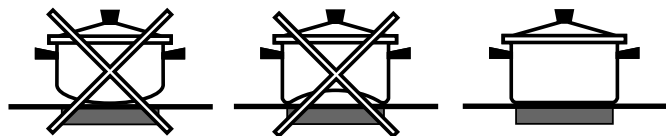

- Always use pans whose diameter covers the cooking zone fully so that all the available heat can be used.



- Make sure the pan base is always clean and dry, to guarantee good contact and long life for the cooking zones and pans alike.
- Avoid using pans used normally on gas burners. The concentration of heat on gas burners can warp the bottom of the pan, consequently you would never obtain the desired result when using the pan on the glass ceramic hob.
- Never leave a cooking zone on without a pan on it as the maximum heat level would be reached very quickly, which could damage the heating elements.
- The glass ceramic hob is resistant to thermal and mechanical shocks. However, it may break due to a shock caused by a sharp object. In this case, **unplug the appliance immediately** and contact an authorised after-sales service centre to have it repaired.

Always keep your hob clean. Before proceeding with maintenance operations, check that all the cooking zones are turned off and have cooled down completely.

Stainless steel frame (only on some models)

Stainless steel can stain as an effect of enduring contact with limescale in water or as an effect of highly aggressive detergents (containing phosphorus). We recommend you rinse and dry it thoroughly after maintenance. It is preferable to remove any water spills immediately.

Hob care

The vitroceramic glass used for the heating surface is smooth and poreless and it is also resistant to thermal shocks and to mechanical shocks under normal conditions of use. In order to preserve these properties, we recommend you care for your hob as follows:

- for ordinary maintenance, just wipe it with a damp sponge and dry it thoroughly using paper towels.
- If the hob is dirty, rub clean using a special cleaner suitable for vitroceramic glass, rinse off and dry thoroughly.
- food residue and dirt can be removed using a special scraper. Do this as soon as possible, do not wait for the hob to cool down in order to avoid incrustations. For excellent results, use a special stainless steel wool pad for vitroceramic glass cleaning soaked in soapy water.
- When the hob is clean, you can apply a special product for the care and protection of the same: this type of product leaves an invisible film on the surface of the hob to protect the same against any spills and boiled-over food. It is best if you do this when the hob is lukewarm or cold.
- Make sure you always rinse the hob with clean water and dry it thoroughly: otherwise the cleaning products could become encrusted onto the hob during subsequent cooking.

Recommendations

- **Never use abrasive or corrosive substances, such as** aerosol cleaners for grills and ovens, stain removers or rust removers, scouring powders and abrasive sponges: even the delicate ones could scratch the hob surface irreversibly.
- We recommend you **keep** all items which could melt **away from the hob**, such as **plastic utensils, sugar or products with a high sugar content**. Should liquid boil over onto the hob surface, **remove** it immediately (while the hob is still hot) using a razor blade scraper, in order to avoid damaging the surface.
- **Use this hob exclusively for cooking**. Do not place items on the hob when the same is not in use. Do not use the hob as a work surface (by placing lids, saucepans or dishcloths on it, for example), nor as a chopping board.
- Never leave aluminium wrappers, aluminium foil and plastic cookware on the hob when hot or still warm.
- Do not use steam cleaners or high pressure cleaners to clean your appliance.
- Do not place metal items on the hob (such as knives, spoons, lids, etc.).
- Never heat up unopened tins: they could burst.

The guarantee does not cover damage to the hob caused by incorrect use.



After Sales Service

"No company is better positioned to offer an after sales service on a Hotpoint appliance than us - the manufacturer"

As part of our commitment to you, all Hotpoint appliances have the added benefit of a fully inclusive parts and labour guarantee for the first 12 months. In addition to this you also have the advantage of **free replacement parts for the first 5 years** when fitted by a Hotpoint engineer. When the 12 months parts and labour guarantee expires we offer the following after sales service options:

Repair Service and Information Help Desk

UK: 08709 066066

www.theservicecentre.co.uk

Republic of Ireland: 1850 302 200

Note: Our operators will require the Model number and the Serial number of your appliance

Available 364 days a year with a fast, effective and value for money service. We have the largest white goods repair service in the UK with over 1200 of our own fully trained engineers. All repairs include a parts and labour guarantee for 12 months from the date of the repair. If you require any information or have any questions about your appliance, our operators are on hand with help and advice.

All this ensures that you will receive the best available after sales service possible.

Extended Warranties

UK: 08709 088 088

www.theservicecentre.co.uk

Republic of Ireland: 1850 502 200

Whether you have just one or a number of Hotpoint appliances in your kitchen, we offer two service cover plans to give you total peace of mind.

- Repair Protection Plan - FREE service repairs for a single Hotpoint appliance during the period of cover.
- Kitchen Cover - FREE service repairs for all your Hotpoint appliances less than 8 years old.

Genuine Parts and Accessories UK: 08709 077 077

www.theservicecentre.co.uk

Republic of Ireland: (01) 842 6836

A wide range of genuine parts and accessories are available from our hotline or through our web site.

Genuine parts and accessories, extended warranties and service repairs are all available on our web-site at:



www.theservicecentre.co.uk





Guarantee

"Satisfaction guaranteed or your money back"

We give you a unique 'satisfaction guaranteed' promise - **valid for 90 days** - after you have purchased your Hotpoint appliance. If there is a technical problem simply call Hotpoint Repair service or visit our web-site at www.theservicecentre.co.uk and where necessary, we will arrange for an engineer to call. If the technical problem is not resolved under this guarantee, **we will replace your machine or, if you prefer, give you your money back.**

All Hotpoint appliances carry a fully inclusive 12 month parts and labour guarantee as well as free replacement parts for the first 5 years (except microwaves, selected integrated appliances and cooker hoods, which have a one year guarantee) provided that they are fitted by a Hotpoint engineer.

Guarantee terms and conditions

Your guarantee is only applicable in the United Kingdom or Republic of Ireland and is subject to the following provisions that your appliance:

- Has been installed and used correctly in accordance with this instruction booklet.
- Has been used solely for domestic purposes and is located on domestic premises (ie. not for commercial or trade use).
- Has been properly connected to a suitable electrical supply voltage as stated on the appliance rating plate.
- Has not been subject to misuse, accident, modified or repaired by anyone other than one of our own service engineers.

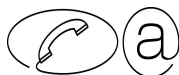

For pre purchase information on any other Hotpoint product call: 08701 50 60 70
or visit: www.hotpoint.co.uk



Recycling & Disposal Information

As part of Hotpoint's continued commitment to helping the environment, Hotpoint reserves the right to use quality recycled components to keep down customer costs and minimise material wastage.

Please dispose of packaging and old appliances carefully.

To minimise risk of injury to children, remove the door, plug and cut mains cable off flush with the appliance. Dispose of these parts separately to ensure that the appliance can no longer be plugged into a mains socket, and the door cannot be locked shut.



Key Contacts

After Sales Service

Over 1200 trained specialists, directly employed by us, ensure that you can have complete confidence in both the appliances and services we offer.



Repair Service and Information Desk

UK: 08709 066 066

(Open 8 to 8 Mon - Fri, 8 to 6 Sat, 10 to 4 Sun & Bank Holidays)

www.theservicecentre.co.uk

Republic of Ireland: 1850 302 200

Note: Our operators will require the following information:

Model number:

Serial number:

Extended Warranties

UK: 08709 088 088

(Open 8 to 8 Mon - Sun)

www.theservicecentre.co.uk

Republic of Ireland: 1850 502 200

Genuine Parts and Accessories

UK: 08709 077 077

(Open 8-30 to 5-30 Mon - Fri & 9 to 12 Sat)

www.theservicecentre.co.uk

Republic of Ireland: (01) 842 6836

Merloni Elettrodomestici UK Ltd, Morley Way, Peterborough, PE2 9JB.

Free Manuals Download Website

<http://myh66.com>

<http://usermanuals.us>

<http://www.somanuals.com>

<http://www.4manuals.cc>

<http://www.manual-lib.com>

<http://www.404manual.com>

<http://www.luxmanual.com>

<http://aubethermostatmanual.com>

Golf course search by state

<http://golfingnear.com>

Email search by domain

<http://emailbydomain.com>

Auto manuals search

<http://auto.somanuals.com>

TV manuals search

<http://tv.somanuals.com>