

EN

English, 1

BFI 670

### Contents

#### **Installation, 2-5**

Positioning and levelling  
Technical data  
Electrical connection  
Connecting the water supply

#### **Description of the appliance, 6**

Overall view  
Control panel

#### **Loading the racks, 7**

Lower rack  
Cutlery basket  
Upper rack

#### **Start-up and use, 8**

Starting the dishwasher  
Loading the detergent  
Washing options

#### **Wash cycles, 9**

Wash cycle table

#### **Rinse aid and refined salt, 10**

Loading the rinse aid  
Loading the refined salt

#### **Care and maintenance, 11**

Shutting off the water and electricity supplies  
Cleaning the dishwasher  
Preventing unpleasant odours  
Cleaning the sprayer arms  
Cleaning the filters  
Leaving the machine unused for extended periods

#### **Precautions and advice, 12-13**

General safety  
Disposal  
Saving energy and respecting the environment

#### **Troubleshooting, 14**

#### **Information for Test Labs, 15**

#### **After Sales Service, 16**

After Sales Service  
Essential Contact Information  
Parts and Accessories  
Appliance Registration

#### **Hotpoint Guarantee, 17**

# Installation

EN

! Keep this instruction manual in a safe place for future reference. If the appliance is sold, given away or moved, please ensure the manual is kept with the machine, so that the new owner may benefit from the advice contained within it.

! Please read this instruction manual carefully: it contains important information regarding the safe installation, use and maintenance of the appliance.

! If the appliance must be moved at any time, keep it in an upright position; if absolutely necessary, it may be tilted onto its back.

## Positioning and levelling

1. Remove the appliance from all packaging and check that it has not been damaged during transportation.

If it has been damaged, contact the retailer and do not proceed any further with the installation process.

2. Check the dishwasher by placing it so that its sides or back panel are in contact with the adjacent cabinets or even with the wall. This appliance can also be recessed under a single worktop\* (*see the Assembly instruction sheet*).

3. Position the dishwasher on a level and sturdy floor. If the floor is uneven, the front feet of the appliance may be adjusted until it reaches a horizontal position (the angle of inclination must not exceed 2 degrees). If the appliance is levelled correctly, it will be more stable and much less likely to move or cause vibrations and noise while it is operating.

4. Adjust the height of the rear feet from the front of the appliance\*: use a screwdriver to tighten or loosen the screws on the lower part of the dishwasher.



### Anti-condensation strip\*

After installing the dishwasher, open the door and stick the adhesive transparent strip under the wooden shelf in order to protect it from any condensation that may form.

## Advice regarding the first wash cycle

After the appliance has been installed, immediately before running the first wash cycle, completely fill the salt dispenser with water and add approximately 2 kg of salt (*see Rinse aid and refined salt*). The water may overflow: this is normal and is not a cause for concern. It is also normal that the LOW SALT\* indicator light continues to flash for a few cycles after the salt has been loaded.

## Technical data

<b>Dimensions</b>	width 59.5 cm height 82 cm depth 57 cm
<b>Capacity</b>	12 standard place-settings
<b>Water supply pressure</b>	30 Kpa ÷ 1Mpa (0.3 ÷ 10 bar) 4.3 psi – 145 psi
<b>Power supply voltage</b>	See appliance data plate
<b>Total absorbed power</b>	See appliance data plate
<b>Fuse</b>	See appliance data plate
 	This dishwasher conforms to the following European Community Directives: -73/23/EEC dated 19/02/73 (Low Voltage) and subsequent modifications -89/336/EEC dated 03/05/89 (Electromagnetic Compatibility) and subsequent modifications -97/17/EC (Labelling) -2002/96/ CE Waste Electrical and Electronic Equipment (WEEE)

\* Only available in selected models.

! The dishwasher meets the requirements set out by the regulations in force concerning safety and electrical equipment.

! Any technical checks should be conducted exclusively by a trained and authorised technician: Repairs carried out by unauthorised persons will invalidate the guarantee, as well as posing a potential hazard to the user.

! The manufacturer declines all responsibility for damage to persons or property resulting from failure to observe the above precautions, from tampering with even a single component or from the use of non-original spare parts.

## Electrical Connection

Before inserting the plug into the electrical socket, make sure that:

- the socket is earthed and complies with current regulations;
- the socket can withstand the maximum load of the appliance, which is indicated on the data plate located on the inside of the door (*see Description of the appliance*);
- the power supply voltage falls within the values indicated on the data plate on the inside of the door;
- the socket is compatible with the plug of the appliance. If this is not the case, ask an authorised technician to replace the plug (*see Assistance*); do not use extension cables or multiple sockets.

! Once the appliance has been installed, the power supply cable and the electrical socket should be easily accessible.

! The cable should not be bent or compressed.

! The cable should be checked regularly and replaced by authorised technicians only (*see Assistance*).

### This appliance must be earthed.

Fuses: your appliance comes fitted with a plug and a 13A fuse. If you need to replace the fuse, only those rated at 13A and ASTA approved to BS1362 should be used. If you lose the fuse cover, a replacement may be obtained from your local authorised Service Centre or Electrical company. Correct replacement is identified by colour coding or the marking on base of plug.

! DO NOT use the plug unless the fuse cover is fitted.

### Changing the Plug

Cut off and dispose of the supplied plug if it does not fit your socket.

! To avoid a shock hazard DO NOT insert the discarded plug into a socket anywhere else.

! Wires in the mains lead are coloured accordance with the following code:

Green/Yellow	-	Earth
Blue	-	Neutral
Brown	-	Live

If you change the plug, the colour of the wires in the mains lead may not correspond with the terminal markings in the plug, which if not coloured, could be:

EARTH	'E'	or
NEUTRAL	'N'	
LIVE	'L'	

### Changing the Mains Lead

A lead can be ordered from Hotpoint Service  
 UK: 08709 066 066 or  
 Republic of Ireland: 1850 302 220

- If you have damaged the existing lead or require a longer one a charge will be made. It is strongly advised that this work is carried out by a qualified electrician.

- If the domestic wiring includes a residual current-operated circuit breaker, ensure that it conforms to the latest regulations.

! The dishwasher must not be connected to the electricity supply while installation is being carried out.

- This appliance should only be connected to a 230/240V AC source, via a properly installed earthed socket.

- Use the dishwasher solely in a domestic environment.

- DO NOT stand or place heavy objects on the door when it is open, this could damage the door or cause the appliance to tip forward.

## Connecting the water supplies

! Connection to the water and electricity supplies should only be performed by a qualified technician.

! The dishwasher should not stand on top of the water hoses or the electricity supply cable.

### Connecting the water inlet hose

The water inlet (A) and outlet (B) hoses and the electricity supply cable may be positioned towards the right or the left in order to achieve the best possible installation (see figure).

- To a suitable cold water connection point: before

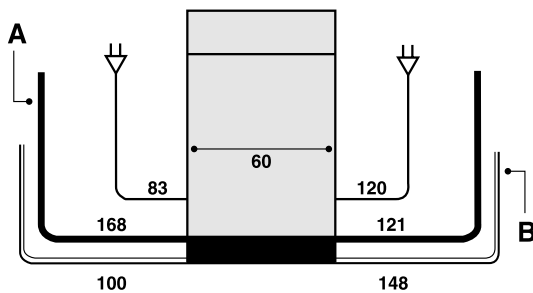

attaching the hose, run the water until it is perfectly clear so that any impurities that may be present in the water do not clog the appliance; after performing this operation, screw the inlet hose tightly onto a tap with a  $\frac{3}{4}$  gas threaded connection.

- To a suitable hot water connection point: your dishwasher may be provided with hot water from the mains supply (if you have a central heating system with radiators) provided that it does not exceed a temperature of 60°C. Screw the hose to the tap as described for connection to a cold water supply.

! If the inlet hose is not long enough, contact a specialist store or an authorised technician (see Assistance).

! The water pressure must be within the values indicated in the Technical data table (see Installation).

! The hose should not be bent or compressed.

! Ensure that the new hose supplied is connected and the old hose is disposed of safely.

! Ensure the fill hose is only fitted to the cold water supply. DO NOT overtighten the hose connector, hand tight is sufficient.

! Ensure the fill hose is not kinked.

! Tap connections\*: A range of adaptors are available to suit your tap.

! DO NOT connect the dishwasher to a single outlet instantaneous water heater or an electric heater.

### Standpipe

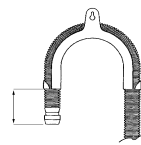

Ensure that the hose is not pushed too far down the standpipe.

If the end of your drain hose is fitted with 'retaining flaps\*', ensure they are inserted fully into the standpipe. This will prevent the pipe from jumping out during installation and use.

! DO NOT position the standpipe near an electrical outlet.

! ENSURE that the drain hose is not kinked and it is routed as shown in the diagram.

The standpipe should have a bore of at least 38mm (1 1/2"). It should be installed as shown, have a trap fitted and must discharge into the same drain system as your household sink.

! It MUST NOT be connected to a surface water drain.

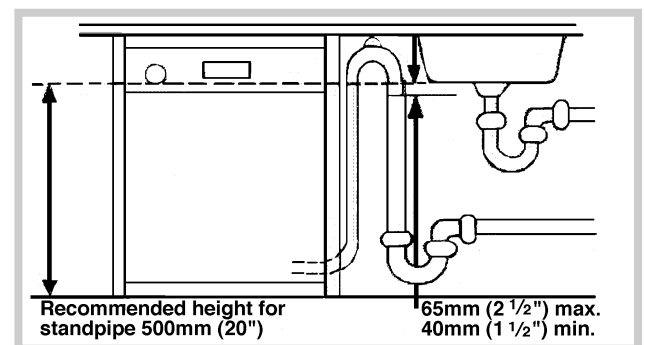

\* Only available in selected models.

## Sink Waste System

### For under sink drainage:

- before connecting the drain hose, remove any internal restrictions; this will prevent a build up of debris which could cause a blockage
- remove any restrictions from the waste spigot and ensure that the sealing bung is removed
- the hose should be routed, such that it is raised to a minimum height of 800mm (31½").

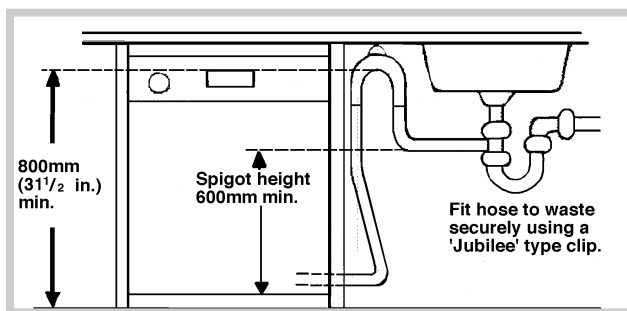

! Ensure the sink outlet pipe has a minimum diameter of 32mm.

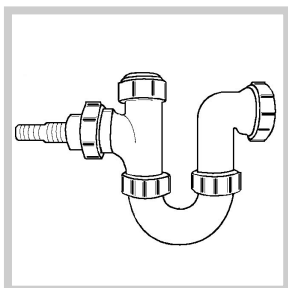

- Untie the end of the GREY drainage hose from the rear of the appliance.
- Reposition the 'Hooked End Support' as required along the GREY drainage hose.

- If fitting an under sink waste disposal unit, cut out the membrane, bung or blanking plug.

! Ensure the drain hose is securely attached, to prevent it coming away while the machine is in use and causing a flood.

## Anti-flooding protection\*

To ensure floods do not occur, the dishwasher:

- is provided with a special system which blocks the water supply in the event of anomalies or leaks from inside the appliance.
- is provided with a *Water Stop\** safety device, in other words it has a water inlet hose that consists of a transparent hose on the outside and a red hose on the inside: both the hoses can withstand extremely high pressure. If the internal hose breaks, the external hose becomes a bright red colour and carries the water instead, thus avoiding any leakage.

! It is very important to check the external hose regularly: if it is a bright red colour, it must be replaced by an authorised technician as soon as possible (see *Assistance*).

\* Only available in selected models.

# Description of the appliance

EN

## Overall view

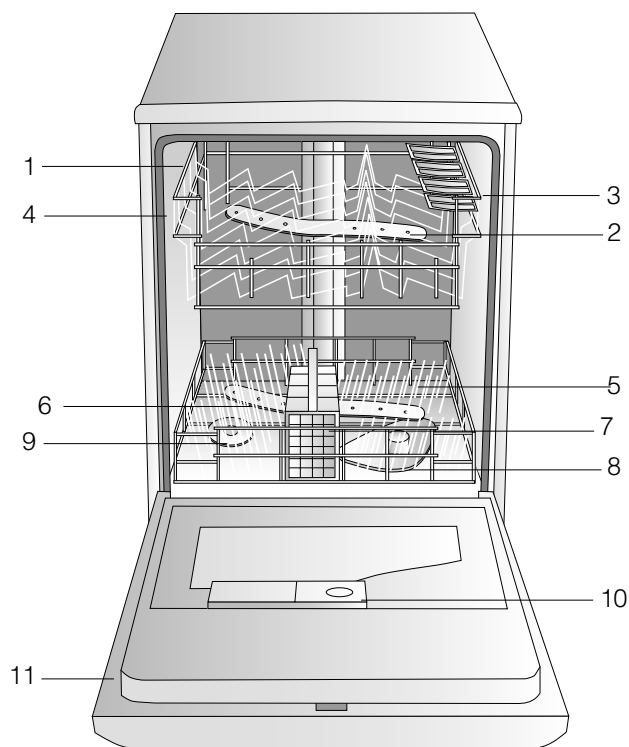

1. Upper rack
2. Upper sprayer arm
3. Tip-up compartments
4. Rack height adjuster
5. Lower rack
6. Lower sprayer arm
7. Cutlery basket
8. Washing filter
9. Salt dispenser
10. Detergent and rinse aid dispensers
11. Data plate

## Control panel

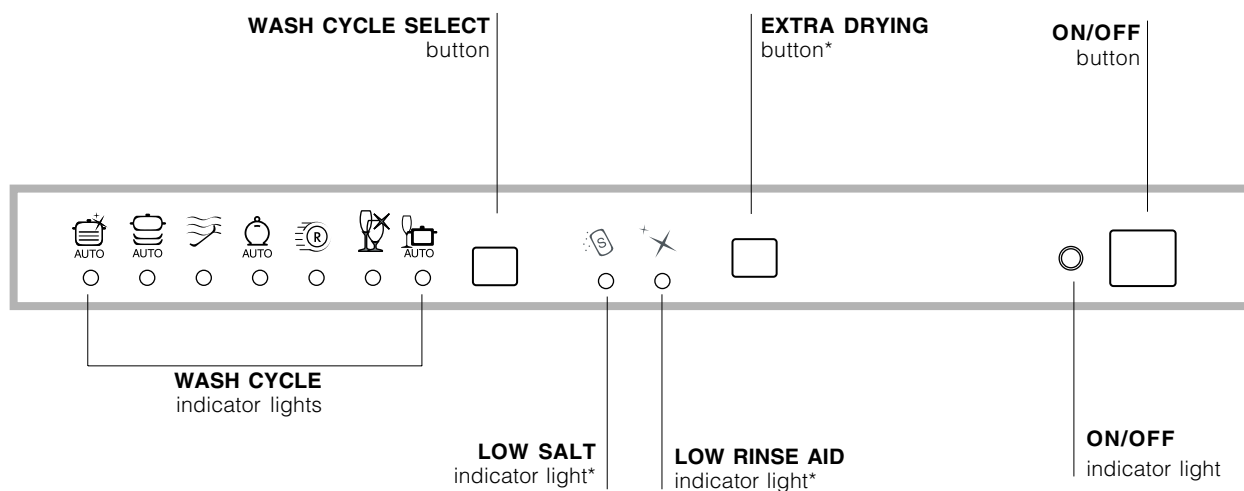

\* Only available in selected models.

# Loading the racks

! Before loading the rack, remove all food residue from the crockery, leave saucepans and frying pans with burnt-on residue to soak in water only and empty all remaining liquid from cups and glasses. After loading the appliance, check that the sprayer arms can rotate freely.

## Lower rack

Arrange the more difficult items to wash using the *Loading examples* as a guide and use the collapsible supports\* where needed.

- Serving dishes and lids: place these at the sides of the rack.
- Saucepans and salad bowls: always turn these upside down.
- Very deep dishes: position these at an angle.

In order to guarantee the best washing and drying performance, the surface of the lower rack is more uneven than that of the upper rack.

## Cutlery basket

The type of cutlery basket may vary according to the dishwasher model.

! Knives and other sharp utensils should be placed in the cutlery basket with the point facing downwards.

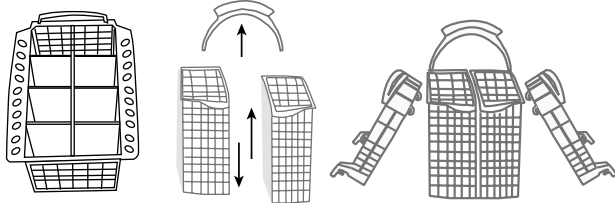

To divide the central basket\* into two separate pieces: pull out the handle. The two detachable side compartments\* may be hooked onto the upper or lower rack.

The two grids\* may be positioned in the basket to separate the cutlery: place the pieces of cutlery into the appropriate compartments with the handles at the bottom.

## Upper rack

Load this rack with delicate and lightweight crockery: glasses, tea and coffee cups, saucers, small salad bowls, saucepans and small saucepans that are not too soiled, using the *Loading examples* as a guide.

- Lightweight crockery: position these dishes so that they will not be moved by the jets of water.
- Mugs and cups: place these on the tip-up compartments\*\*.
- Long sharp knives and serving utensils: place these on the tip-up compartments\*\*.

## Adjusting the height of the upper rack

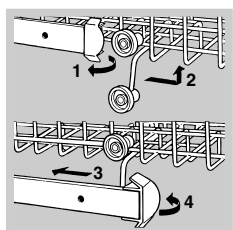

In order to make it easier to arrange the crockery, the upper rack may be moved to a higher or lower level. Open the left and right guide rail stops and pull out the rack; position it higher or lower as required, slide it along the guide rails until the front wheels are in place and close the stops (see figure).

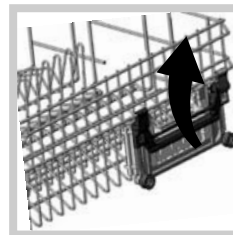

If the rack is equipped with the click clack handles\* (see figure), pull them upwards or downwards to adjust the height.

## Loading examples for the upper rack

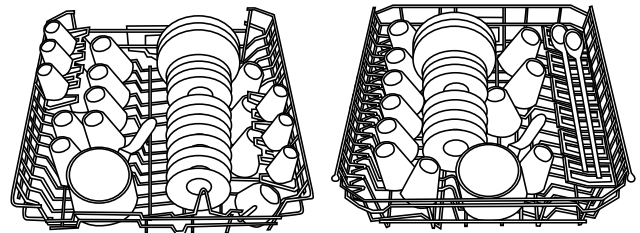

## Loading examples for the lower rack

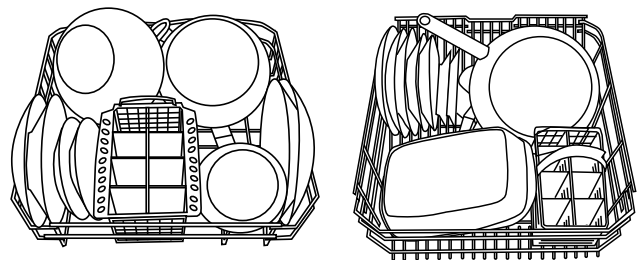

## Baby Tip-up compartments\*\*

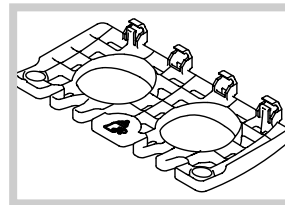

For dishwasher models with a Baby Cycle, tip-up compartments which are suitable for washing bottles, rings and teats are provided (and have their own instruction sheet).

## Items that should not be washed in the dishwasher

- Wooden items, objects with wooden or horn handles or glued-on parts.
- Items made from aluminium, copper, brass, pewter or tin.
- Items made from plastic that is not heat-resistant.
- Antique or hand-painted porcelain.
- Antique silver. Silver that is not antique may, however, be washed in the dishwasher using a delicate wash cycle, provided that it does not come into contact with other metals.

! When buying crockery and cutlery we recommend that you check whether it can be washed using the dishwasher.

## Washing the handles\*

To wash the upper and lower rack handles: remove the two fastening plugs, lift out the handles and rinse them under running water, then fasten them to the rack using the same plugs.

\* Only available in selected models.

\*\* The number and position may vary.

# Start-up and use

EN

## Starting the dishwasher

1. Turn the water tap on.
2. Open the door and press the ON/OFF button: the indicator light will illuminate.
3. Measure out the detergent (see below).
4. Load the racks (see Loading the racks).
5. Select the programme by pressing the WASH CYCLE SELECT button; the corresponding indicator light will illuminate.
6. Select the wash options (see below).
7. Start the wash cycle by shutting the door: the machine will emit a confirmation beep.
8. At the end of the cycle two short beeps will sound and the WASH CYCLE indicator light will flash. Open the door, switch off the appliance by pressing the ON/OFF button, shut off the water tap and unplug the appliance from the electricity socket.
9. Wait for a few minutes before removing the crockery, in order to avoid burns. Unload the racks, beginning with the lower level.

### Modifying a wash cycle in progress

If a mistake was made during the wash cycle selection process it is possible to change the cycle, provided that it has only just begun: open the door, taking care to avoid the escaping steam, and press the WASH CYCLE SELECT button, holding it for 4 seconds. After one long beep and three short beeps, the WASH CYCLE indicator light will switch off: select the new wash cycle and start the programme by shutting the door.

### Adding extra crockery

Open the door, taking care to avoid the escaping steam, and place the crockery inside the dishwasher. Close the door: the cycle starts from the point at which it was interrupted.

### Accidental interruptions

If the door is opened during the wash cycle, or if there is a power cut, the cycle stops. It starts again from the point at which it was interrupted once the door has been shut or the electricity supply is restored.

## Loading the detergent

A successful wash also depends on the correct amount of detergent being used, as recommended by the manufacturer. Exceeding the recommended amount does not result in a more effective wash and pollutes the environment.

! To obtain the best results from each washing and drying cycle, powder detergent, rinse aid liquid and salt should be used.

**compartment A:** Washing detergent

**compartment B:** Pre-wash detergent

1. Open cover C by pressing button D.
2. Pour in the detergent after consulting the *Wash cycle table*:

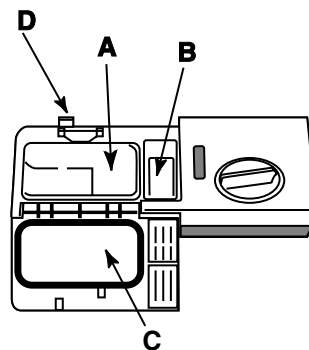

- for powder detergent use compartments A and B
- for tablets, use compartment A and the bottom of the appliance,

i.e. when the cycle requires 1 tablet, place it in compartment A and close the cover; when it requires 2, place the second tablet at the bottom of the appliance.

3. Remove detergent residues from the edges of the compartment and close the cover until it clicks.

## Washing options

### Extra drying\*

To make sure that the crockery is completely dry at the end of the cycle, press the EXTRA DRYING button before selecting the wash cycle. A prolonged beep will sound to indicate that this option has been selected and a short beep will sound to indicate when it has been deselected.

! This option is incompatible with the soak cycle.

! If the Extra drying option is selected, the wash cycles will last longer.

\* Only available in selected models.









# Wash cycles

## Wash cycle table

! Ariston dishwashers are fitted with an automatic filter cleaning system that may increase the cycle duration.

! AUTO WASH CYCLES: This model of dishwasher is equipped with a special sensor which can be used to assess the level of soiling and automatically select the most efficient and economic wash cycle accordingly. The duration of the auto wash cycles may vary due to the operation of the sensor.

! If the crockery is only lightly soiled or if it has been rinsed with water before being placed in the dishwasher, reduce the amount of detergent used accordingly.

Wash cycle Selection instructions	Wash cycle	Detergent (A) = compartment A (B) = compartment B			Pre-wash	Drying	Wash cycle duration (tolerance ±10%)
		Powder	Liquid	Tablets			
Extremely soiled dishes and pans (not to be used for delicate items).	 AUTO Super Wash	30 g (A) 5 g (B)	30 ml (A) 5 ml (B)	1 (A) 1 (bottom of the appliance)	•	•	2:05'
Normally soiled pans and dishes. Standard daily wash cycle.	 AUTO Normal	30 g (A)	30 ml (A)	1 (A)	•	•	1:45'
Preliminary wash cycle for dishes while the load is awaiting completion with the dishes from the next meal.	 Soak						12'
Environmentally-friendly wash cycle with low energy consumption levels, suitable for pans and dishes.	 AUTO Eco	25 g (A) 5 g (B)	25 ml (A) 5 ml (B)	1 (A)	•	•	2.25'
Economic and fast wash cycle to be used for lightly soiled dishes. (Run cycle immediately after use.)	 Rapid	25 g (A)	25 ml (A)				30'
Economic and fast wash cycle to be used for more delicate items which are sensitive to high temperatures. (Run cycle immediately after use.)	 Glassware	25 g (A)	25 ml (A)	1 (A)		•	1:38'
Wash differentiated on the two racks delicate for glassware and glasses on the upper rack and heavy duty for the pans on the lower rack.	 AUTO Duo Wash	25 g (A) 5 g (B)	25 ml (A) 5 ml (B)	1 (A)	•	•	1:48'

### Note

To make it easier to measure out the detergent, it is worth remembering that:

1 tablespoon = 15 grams of powder = approximately 15 ml of liquid

1 teaspoon = 5 grams of powder = approximately 5 ml of liquid

# Rinse aid and refined salt

EN

! Only use products that have been specifically designed for dishwashers.

Do not use table salt or industrial salt.

! If using a multi-functional product (2-in-1, 3-in-1, 4-in-1, etc.) it is not necessary to add rinse aid; however, we recommend that you add salt, especially if you live in an area where the water is hard or very hard. If you do not add salt or rinse aid, the LOW SALT\* and LOW RINSE AID\* indicator lights will flash continuously.

## Loading the rinse aid

Rinse aid makes it easier for the crockery to dry, as water runs off surfaces more readily and therefore does not leave streaks or marks.

The rinse aid dispenser should be filled:

- whenever the indicator light (H) signals that it is empty. Illuminated light: add rinse aid; unlit light: there is no shortage of rinse aid in the dispenser.
- when the LOW RINSE AID\* indicator light on the panel flashes;

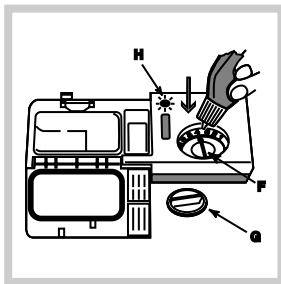

1. Open the dispenser by turning the lid (G) in an anticlockwise direction.
2. Pour in the rinse aid, making sure it does not overflow from the dispenser. If this happens, clean the spill immediately with a sponge.
3. Screw the lid back on. NEVER pour the rinse aid directly into the appliance tub.

## Adjusting the amount of rinse aid

If you are not completely satisfied with the washing or drying results, you may adjust the quantity of rinse aid used. Use a screwdriver to turn the dosage adjuster to one of the 6 pre-set positions (the default position is set to 4):

- if there are bluish streaks on the crockery, set the adjuster to a lower number (1-3).
- if drops of water remain on the crockery or there are limescale marks present after the cycle has finished, set the adjuster to a higher number (4-6).

! If you are using multi-functional tablets (2-in-1, 3-in-1, 4-in-1, etc.) and you wish to further improve the drying performance of the appliance, fill the dispenser and set the dosage adjuster to 2.

## Loading the refined salt

In order to obtain the best possible results from a wash cycle, make sure that the dispenser is never empty. Refined salt removes limescale from the water, thus avoiding the formation of deposits on crockery. The salt dispenser is located in the lower part of the dishwasher (see *Description*) and should be filled:

- when the green float\* cannot be seen by simply looking at the cap of the salt dispenser;
- when the LOW SALT\* indicator light on the panel flashes;
- if your machine is not equipped with an indicator light or a green float: approximately every 30 wash cycles;

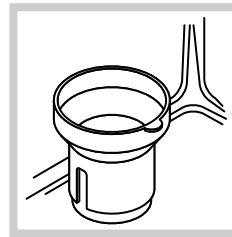

1. Remove the lower rack and unscrew the cap of the dispenser (in an anti-clockwise direction).
2. For the first wash cycle only: fill the dispenser up to the edges with water.
3. Position the funnel provided correctly (see figure) and fill the salt

dispenser up to the edges (approximately 2 kg); it is normal for a little water to leak out.

4. Remove the funnel, wipe away any salt residue from the thread and screw the cap on tightly, so that detergent does not leak into the dispenser during the wash cycle (this could damage the water softening system beyond repair).

! When salt has been added, run a wash cycle immediately, without crockery, in order to remove any salt solution that has leaked out and to avoid corrosion.

## Adjusting the amount of salt\*

It is possible to adjust the amount of salt used according to the hardness of the water in your area (this information is available from your local water board).

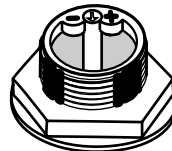

1. Unscrew the dispenser cap.
2. Turn the arrow on the neck of the dispenser (see figure) towards the + or - symbols, using the table below as a guide.

Hardness of the water			Selector knob position	Salt consumption (grams/cycle)	Autonomy (cycle/2 kg)
°dH	°fH	°mmol/l			
0-10	0-17	0-1,7	/	0	/
10-25	18-44	1,8-4,4	—	20	60
25-50	45-89	4,5-8,9	MED	40	40
> 50	> 89	> 8,9	+	60	25

The default setting of the water softening system is +.

If using multi-functional tablets (2-in-1, 3-in-1, 4-in-1, etc.) fill the salt dispenser and set the adjuster to -; if the hardness of the water is greater than 60°fH, set it to +.

\* Only available in selected models.

## Shutting off the water and electricity supplies

- Turn off the water tap after every wash cycle to avoid leaks.
- Remove the plug from the socket when cleaning the machine and when carrying out maintenance work.

## Cleaning the dishwasher

- The external surfaces of the machine and the control panel may be cleaned using a non-abrasive cloth which has been dampened with water. Do not use solvents or abrasive products.
- Any marks on the appliance interior may be removed using a cloth dampened with water and a little vinegar.

## Preventing unpleasant odours

- Always keep the door of the appliance ajar in order to avoid moisture from forming and being trapped inside the machine.
- Clean the seals around the door and detergent dispensers regularly using a damp sponge. This will avoid food becoming trapped in the seals, which is the main cause of the formation of unpleasant odours.

## Cleaning the sprayer arms



Food residue may become encrusted onto the sprayer arms and block the holes used to spray the water. It is therefore recommended that the arms are checked from time to time and cleaned with a small non-metallic brush.

## Cleaning the filters

The filters remove food residue from the water used in the wash cycle: to obtain the best results from each wash, they should be cleaned.

! Clean the filters regularly.

! After cleaning check that the filter assembly has been replaced correctly.

! The dishwasher should not be used without filters, or when the filter is loose.

1. Remove the filters by pulling the handle upwards.

2. Clean the filters:

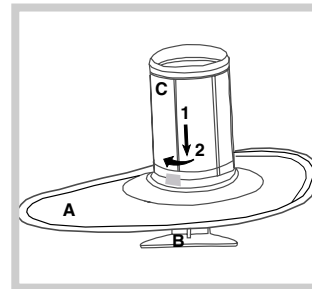

- after every wash cycle, remove the largest pieces of residue from semicircular plate A and glass B (these may be removed by pulling the handle) by rinsing them under running water.

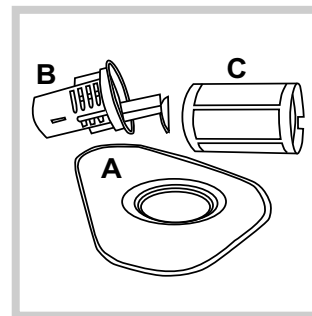

- The entire filter assembly should be cleaned thoroughly once a month: this includes the semicircular plate A, the glass B and the cylinder C (this may be removed by turning it in an anti-clockwise direction).

Use a small non-metallic brush to clean these parts.

3. Reconstruct the filter assembly and replace it in the correct position, following movements 1 and 2 as shown in the figure, until it clicks into place.

## Leaving the machine unused for extended periods

- Run a wash cycle when the dishwasher is empty.
- Unplug the appliance and disconnect the water supply.
- Leave the door of the appliance ajar.

# Precautions and advice

EN

! The appliance was designed and manufactured in compliance with current international safety standards. The following information has been provided for safety reasons and should therefore be read carefully.

## General safety

- The appliance was designed for domestic use inside the home and is not intended for commercial or industrial use.
- The appliance must be used by adults only, to wash domestic crockery according to the instructions in this manual.
- The appliance must not be installed outdoors, even in covered areas. It is extremely dangerous to leave the machine exposed to rain and storms.
- Do not touch the appliance when barefoot.
- When unplugging the appliance always pull the plug from the mains socket, do not pull on the cable.
- The water supply tap must be shut off and the plug should be removed from the electrical socket before cleaning the appliance or carrying out any maintenance work.
- If the appliance breaks down, do not under any circumstances touch the internal parts in an attempt to carry out the repair work yourself.
- Never touch the heating element.
- Do not lean or sit on the open door of the appliance: this may cause the appliance to overturn.
- The packaging material should not be used as a toy: it can become a choking or suffocation hazard.

### If your family includes children:

- DO NOT allow children to play with the appliance or tamper with its controls.
- Keep detergents and rinse aids away from children.
- Keep children away from the open door of a dishwasher, there could still be some detergent left inside.

## Disposal of old electrical appliances

The European Directive 2002/96/EC on Waste Electrical and Electronic Equipment (WEEE), requires that old household electrical appliances must not be disposed of in the normal unsorted municipal waste stream. Old appliances must be collected separately in order to optimise the recovery and recycling of the materials they contain and reduce the impact on human health and the environment. The crossed out "wheeled bin" symbol on the product reminds you of your obligation, that when you dispose of the appliance it must be separately collected.

Consumers should contact their local authority or retailer for information concerning the correct disposal of their old appliance.

## Saving energy and respecting the environment

### Saving water and energy

- Only start a wash cycle when the dishwasher is full. While waiting for the dishwasher to be filled, prevent unpleasant odours with the Soak cycle (*see Wash Cycles*).
- Select a wash cycle that is suited to the type of crockery and to the soil level of the crockery using the *Wash cycle table*:
  - for dishes with a normal soil level, use the Eco wash cycle, which guarantees low energy and water consumption levels.
  - if the load is smaller than usual activate the Half load option (*see Start-up and use*).
- If your electricity supply contract gives details of electricity saving time bands, run wash cycles during the periods when a lower tariff is applied. The Delayed start\* button (*see Start-up and use*) helps you organise the wash cycles accordingly.

### **Phosphate-free and chlorine-free detergents containing enzymes**

- We strongly recommend that you use detergents that do not contain phosphates or chlorine, as these products are harmful to the environment.
- Enzymes provide a particularly effective action at temperatures around 50°C, and as a result detergents containing enzymes can be used in conjunction with low-temperature wash cycles in order to achieve the same results as a normal 65°C wash cycle.
- To avoid wasting detergent, use the product in appropriate quantities based on the manufacturer's recommendations, the hardness of the water and the soil level and quantity of the crockery. Even if they are biodegradable, detergents contain substances that may alter the balance of nature.



### **Recycling & Disposal Information**

As part of Hotpoint's continued commitment to helping the environment, Hotpoint reserves the right to use quality recycled components to keep down customer costs and minimise material wastage.

Please dispose of packaging and old appliances carefully.

To minimise risk of injury to children, remove the door, plug and cut mains cable off flush with the appliance.

Dispose of these parts separately to ensure that the appliance can no longer be plugged into a mains socket and the door cannot be locked shut.

\* Only available in selected models.

# Troubleshooting

EN

Whenever the appliance fails to work, check for a solution from the following list before calling for Assistance (see Assistance).

<b>Malfunction:</b>	<b>Possible causes / Solutions:</b>
<b>The dishwasher does not start.</b>	<ul style="list-style-type: none"> <li>• The plug has not been inserted into the electrical socket properly, or there is no power in the house.</li> <li>• The dishwasher door has not been shut properly.</li> <li>• A delayed start has been programmed (see <i>Start-up and use</i>).</li> </ul>
<b>No water enters the dishwasher.</b>	<ul style="list-style-type: none"> <li>• There is no water in the mains supply.</li> <li>• The water inlet hose is bent (see <i>Installation</i>).</li> </ul>
<b>No water drains out from the dishwasher.</b>	<ul style="list-style-type: none"> <li>• The dishwasher cycle has not yet finished.</li> <li>• The water outlet hose is bent (see <i>Installation</i>).</li> <li>• The drain duct is blocked.</li> <li>• The filter is clogged up with food residues.</li> </ul>
<b>The dishwasher makes excessive noise.</b>	<ul style="list-style-type: none"> <li>• The dishes are rattling against each other or against the sprayer arms.</li> </ul>
<b>The dishes and glasses are covered in a white film or limescale deposits.</b>	<ul style="list-style-type: none"> <li>• The level of the refined salt is low or the dosage setting is not suited to the hardness of the water (see <i>Rinse aid and salt</i>).</li> <li>• The lid on the salt dispenser is not closed properly.</li> <li>• The rinse aid has been used up or the dosage is too low.</li> <li>• The crockery is made from non-stick material.</li> </ul>
<b>The dishes and glasses are streaked or have a bluish tinge.</b>	<ul style="list-style-type: none"> <li>• The rinse aid dosage is too high.</li> </ul>
<b>The crockery has not been dried properly.</b>	<ul style="list-style-type: none"> <li>• The rinse aid has been used up or the dosage is too low (see <i>Rinse aid and salt</i>).</li> <li>• The rinse aid dispenser setting is not high enough.</li> <li>• A wash cycle without a drying programme has been selected.</li> </ul>
<b>The dishes are not clean.</b>	<ul style="list-style-type: none"> <li>• The racks are overloaded (see <i>Loading the racks</i>).</li> <li>• The crockery has not been arranged well.</li> <li>• The sprayer arms cannot move freely.</li> <li>• The wash cycle is too gentle (see <i>Wash cycles</i>).</li> <li>• The detergent has not been measured out correctly or it is not suited to the type of wash cycle (see <i>Start-up and use</i>).</li> <li>• The filter is dirty or blocked (see <i>Care and maintenance</i>).</li> <li>• The refined salt level is low (see <i>Rinse aid and salt</i>).</li> </ul>
<b>Tap shut-off alarm.</b> <b>(several short beeps are emitted)</b>  (the second and third WASH CYCLE indicator lights flash, beginning from the right).	<ul style="list-style-type: none"> <li>• Turn on the tap and the appliance will start after a few minutes.</li> <li>• The appliance lock has been activated because no action was taken when the beeps sounded. Switch off the machine using the ON/OFF button, turn on the tap and switch the machine back on after 20 seconds by pressing the same button. Re-programme the machine and restart the wash cycle.</li> </ul>
<b>Clogged filter alarm</b> (the second and fourth WASH CYCLE indicator lights flash, beginning from the right).	<ul style="list-style-type: none"> <li>• Switch off the machine by pressing the ON/OFF button and clean the filters (see <i>Maintenance</i>), then switch the dishwasher back on by pressing the same button. Re-programme the machine and restart the wash cycle.</li> </ul>
<b>Water loading solenoid valve malfunction alarm</b> (the third WASH CYCLE indicator light flashes, beginning from the right).	<ul style="list-style-type: none"> <li>• Switch off the appliance by pressing the ON/OFF button and switch it back on after a minute. If the alarm continues, shut off the water tap to eliminate the risk of flooding, remove the plug from the electrical socket and call Assistance.</li> </ul>

## Load for 12 Standard Settings tests (upper rack at top position)

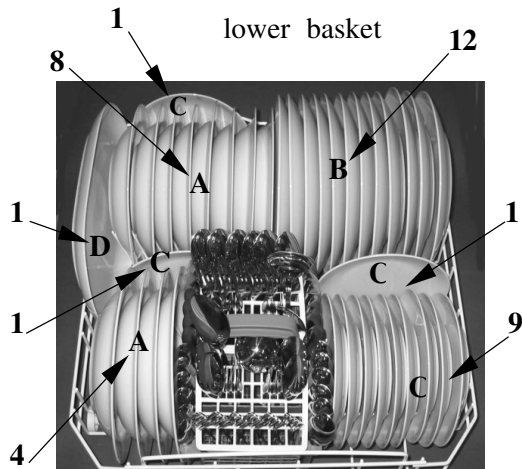

Lower basket			Upper basket		
Type	Item	Diameter Volum (approximately)	Type	Item	Diameter/Volum (approximately)
A	soupe plate	23 cm.	e	cup	0,20 l.
B	dinner plate	26 cm.	f	serving bowl	19 cm.
C	dessert plate	19 cm.	g	glass	250 ml.
D	oval platter	32 cm.	h	saucer	14 cm.
			k	serving bowl	13 cm.
			i	serving bowl	16 cm.

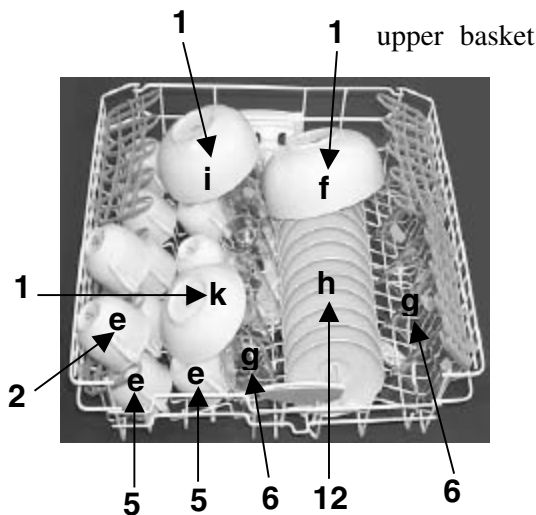

### Loading the detergent

The cleaning detergent should be introduced into the two containers "Comp.2" and "Comp.3" (see table at the end of the page).

### Loading the Rinse Aid

The amount of rinse aid used for each cycle can be regulated by turning the dose adjuster 'F' which you will find under lid 'C'. There are 6 different settings; the normal dosage is setting 5.

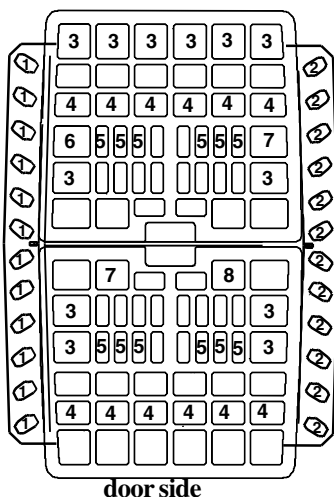
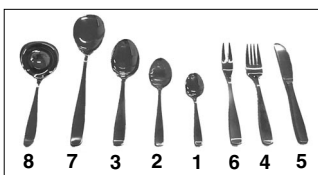
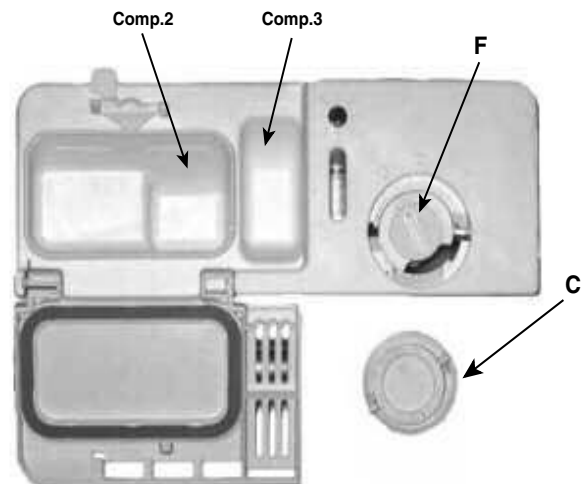

This basket is equipped with two removable grids; insert the cutlery one by one into the slots, with the handles at the bottom. Position them so that they don't touch.

	Cycle	Total detergent	Comp.2	Comp.3
<b>EN 50242</b>	Eco	30 gr.	25	5
<b>IEC/DIN</b>	Eco+extra dry*	30 gr.	30	

\* Press the "extra dry" button, if existing.

# After Sales Service

EN

## After Sales Service

**No one is better placed to care for your Hotpoint appliance during the course of its working life than us - the manufacturer.**

## Essential Contact Information

### Hotpoint Service

We are the largest service team in Europe offering you access to 400 skilled telephone advisors and 1100 fully qualified engineers on call to ensure you receive fast, reliable, local service.

UK: 08709 066 066  
Republic of Ireland: 0818 313 413  
[www.hotpointservice.co.uk](http://www.hotpointservice.co.uk)

Please note: Our advisors will require the following information:

**Model number:**

**Serial number:**

## Parts and Accessories

We supply a full range of genuine replacement parts as well as accessory products that protect and hygienically clean your appliance to keep it looking good and functioning efficiently throughout its life.

UK: 08709 077 077  
Republic of Ireland: 0818 313 413  
[www.hotpointservice.co.uk](http://www.hotpointservice.co.uk)

## Appliance Registration

We want to give you additional benefits of Hotpoint ownership. To activate your free 5 year parts guarantee you must register your appliance with us.

UK: 0870 6092094  
Republic of Ireland: 01 230 0800  
[www.hotpointservice.co.uk](http://www.hotpointservice.co.uk)

Indesit Company UK Ltd. Morley Way,  
Peterborough, PE2 9JB

Indesit Company Unit 49 Airways Industrial  
Estate, Dublin 17



## 12 Months Parts and Labour Guarantee

Your appliance has the benefit of our manufacturer's guarantee, which covers the cost of breakdown repairs for twelve months from the date of purchase.

This gives you the reassurance that if, within that time, your appliance is proven to be defective because of either workmanship or materials, we will, at our discretion, either repair or replace the appliance at no cost to you.

## Guarantee terms and conditions

This guarantee is subject to the following conditions:

- The appliance has been installed and operated correctly and in accordance with our operating and maintenance instructions.
- The appliance is used only on the electricity or gas supply printed on the rating plate.
- The appliance has been used for normal domestic purposes only.
- The appliance has not been altered, serviced, maintained, dismantled, or otherwise interfered with by any person not authorised by us.

### The guarantee does not cover:

- Damage resulting from transportation, improper use, neglect or interference or as a result of improper installation.
- Replacement of any consumable item or accessory. These include but are not limited to: plugs, cables, batteries, light bulbs, fluorescent tubes and starters, covers and filters.
- Replacement of any removable parts made of glass or plastic.

**THIS GUARANTEE WILL NOT APPLY IF THE APPLIANCE HAS BEEN USED IN COMMERCIAL OR NON-DOMESTIC PREMISES.**

## 5 Year Parts Guarantee

Hotpoint also offers you a free 5 year parts guarantee. This additional guarantee is conditional on you registering your appliance with us and the parts being fitted by one of our authorised engineers. There will be a charge for our engineer's time. To activate the extra parts warranty on your appliance, simply call our registration line on 0870 6092094 (ROI 01 230 0800).

## Extended Guarantees

We offer a selection of repair protection plans that enable you to fully cover yourself against the expense of repair bills for the life of your policy. To find the ideal plan for you please call our advice line on 08709 088 088 (ROI 01 230 0233).

## Free Helpdesk Service

We have a dedicated team who can provide free advice and assistance with your appliance if you experience any technical difficulties within the first 90 days of ownership. Simply call our Hotpoint Service Hotline on 08709 066 066 (ROI 0818 313 413) for telephone assistance, or, where necessary, to arrange for an engineer to call. If we cannot resolve the technical problem we will replace your machine or, if you prefer, give you your money back.

# Notes

---

EN



### **Retention of this Instruction Book**

This Instruction Book must be kept handy for reference as it contains important details on the safe and proper use of the appliance.

If you sell or pass the appliance to someone else, or move house and leave it behind, make sure this Book is also provided so the new owner can become familiar with the appliance and safety warnings.

If the Book is lost or damaged a copy may be obtained from:  
Indesit Company UK Ltd. Morley Way, Peterborough, PE2 9JB  
[www.hotpointservice.co.uk](http://www.hotpointservice.co.uk)

## Free Manuals Download Website

<http://myh66.com>

<http://usermanuals.us>

<http://www.somanuals.com>

<http://www.4manuals.cc>

<http://www.manual-lib.com>

<http://www.404manual.com>

<http://www.luxmanual.com>

<http://aubethermostatmanual.com>

Golf course search by state

<http://golfingnear.com>

Email search by domain

<http://emailbydomain.com>

Auto manuals search

<http://auto.somanuals.com>

TV manuals search

<http://tv.somanuals.com>