

How to get the best from **Your Dishwasher**

Contents

Air Gap	21
Appliance Registration	2
Care and Cleaning	21
China, Crystal, Sterling	17
Cycle Features	11
Detergent, Detergent Guide	12, 13
Dispenser Cups	13
Energy-Saving Tips	2
Front Panel Color Change	22
Loading	14-16
Lock Controls Feature	6
Model and Serial Numbers	2
Operating Instructions	4-6
Cycle Selection	4
Dishwashing Shortcut	6
Drying Options	5
Soil Level	4
Pots & Pans	4, 13
Problem Solver	18-20
Repair Service	23
Rinse Agent	12
Safety Instructions	3
Systems Monitor	7-10
User Maintenance Instructions	21
Warranty	Back Cover
Water Temperature	12
Winter Storage	21

Use and Care of
built-in model
HDA2600K

GE Answer Center®
800.626.2000

HOTPOINT

Help us help you...

Before using your dishwasher, read this book carefully.

It is intended to help you operate and maintain your new dishwasher properly.

Keep it handy for answers to your questions.

If you don't understand something or need more help, write (include your phone number):

Consumer Affairs
Hotpoint
Appliance Park
Louisville, KY 40225

Write down the model and serial numbers,

You'll find them on a label just inside the dishwasher door.

These numbers are also on the Consumer Product Ownership Registration Card that came with your dishwasher. Before sending in this card, please write these numbers here:

Model Number

Serial Number

Use these numbers in any correspondence or service calls concerning your dishwasher.

Convenience features

This dishwasher has many convenient features. Among them are:

- Controls are arranged left to right as you use them.
- Automatic "beep" responses to instructions and a lighted display let you know the desired function has been selected.
- Lets you adjust your washing cycle to the amount of soil on your dishes.

If you received a damaged dishwasher . . .

Immediately contact the dealer (or builder) that sold you the dishwasher.

Save time and money. Before you call for service . . .

Check the Problem Solver (pages 18-20). It lists causes of minor operating problems that you can correct yourself.

Energy-saving tips

The power consumption of your dishwasher can be minimized if you follow these suggestions:

- **Operate the dishwasher only when it's full.** Let the dishes accumulate in the dishwasher. When you put in only a partial load, use the RINSE & HOLD Cycle to rinse off heavy soils. Be sure to latch the door when waiting for a full load. This helps to keep soils moist, easier to remove.

- **Always select the cycle that uses the least amount of water that will remove the soil from the load.** See page 11.

- Select the SOIL LEVEL that will remove soil from load.

- If you don't need your dishes right away, **use your ENERGY SAVER** drying that turns the drying heater off automatically. Dishes dry naturally over a longer period such as overnight.

- Watch the SYSTEMS MONITOR for more ideas. See page 7.

- Lets you **select** fast, heated drying or energy-saving, no-heat drying.
- A SYSTEMS MONITOR that tells you what's happening in the dishwasher and if certain things are wrong.
- Lets you **LOCK** the controls to prevent accidental tampering.
- Remembers your last cycle so you don't have to reprogram each time. See **SHORTCUT** on page 6.

IMPORTANT SAFETY INSTRUCTIONS

Read all instructions before using this appliance.

WARNING—When using this appliance, always exercise **basic** safety precautions, including the following:

• Use this appliance only for its intended purpose, as you will find **described** in this Use and Care **Book**.

• This dishwasher must be properly **installed and located in accordance with the Installation Instructions before it is used**. If you did not receive an Installation Instructions sheet with your dishwasher, **you** can obtain one by contacting the service location nearest you,

–This appliance must be connected to a grounded **metal**, permanent wiring system; or an equipment-grounding conductor must be run with the circuit conductors and connected to the equipment-grounding terminal or lead of the appliance.

–Connect to a properly rated, protected and sized power-supply circuit to avoid **electrical** overload.

• Use only powder or liquid detergents or wetting agents recommended for use in a dishwasher.

• Do not wash plastic items **unless marked** “dishwasher safe” or the **equivalent**. For plastic items not so marked, check the **manufacturer’s** recommendations.

• Load light plastic items so they will not become **dislodged** and drop to the bottom of the dishwasher—they might come into contact with the heating unit and be damaged.

To minimize the possibility of injury.

• **When** loading items to be washed:

A. Locate sharp items so that they are not likely to damage **the** door seal, and

B. Load sharp knives with the handles up to reduce the risk of cut-type injuries.

• Do not touch the heating **element** during or immediately **after** use.

• Do not operate your dishwasher unless all enclosure panels are properly in place.

• Do not tamper with controls.

• Do not abuse, sit on, or stand on the door or dish rack of the dishwasher.

• Close supervision is necessary if this appliance is **used** by or near children. Do not allow children to play inside, on or with this appliance or any discarded appliance. Dispose of discarded appliances and shipping or packing material properly. Before discarding a dishwasher, remove the door of the washing compartment.

• Keep **all** washing detergents and wetting agents out of the reach of children, preferably in a locked cabinet. Observe all warnings on container labels to avoid personal injury.

• **HYDROGEN GAS** is produced by the chemical action within your water heater. It can accumulate in the water heater and/or water pipes if hot water has not been used for a period of **two weeks** or longer. **HYDROGEN GAS IS EXPLOSIVE**. To prevent the possibility of damage or injury, if you have not used hot water for two weeks or more, or move into a residence in which the hot water system may not have been used for some time, turn on all hot water faucets and allow them to run for several minutes before using any electrical appliance which is connected to the hot water system. This will allow any hydrogen gas to escape. Also, since the gas is flammable, do not smoke or use an open flame or appliance during this process.

SAVE THESE INSTRUCTIONS

How to operate the dishwasher

STEP 1

Load your dishwasher with dishes, silverware, pots, pans, bowls, etc. according to instructions on pages 14 through 16.

STEP 2

Add detergent to the detergent dispenser.

Use rinse aid agent to help prevent spotting. (See page 12.)

Close and latch dishwasher door.

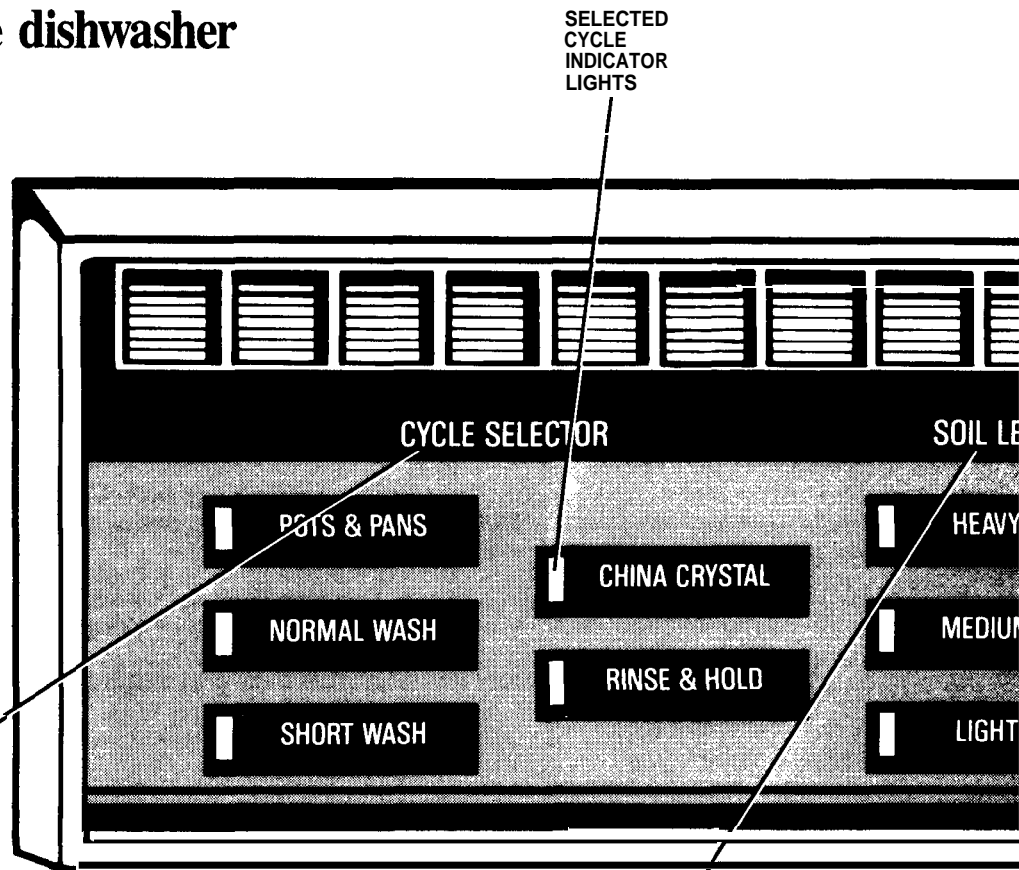

STEP 3

Select desired wash cycle

Touch the center of the pad.

- **POTS & PANS** is for items such as pots, pans and casseroles. Everyday dishes may be included.
- **NORMAL WASH** is for loads of everyday dishes with medium soils. Designed to yield high performance on normal loads.
- **SHORT WASH** is for most loads of everyday dishes with light soils or soils that have not dried on. It saves hot water over the higher performance cycles, thus saving energy. *Pre-rinse dishware before loading.*

- **CHINA-CRYSTAL** is for lightly soiled china and crystal. The wash action is **softened** by pumping air along with the water to protect your delicate items. *Pre-rinse dishware before loading.* Follow loading instructions on pages 14 through 16.
- **RINSE & HOLD** is for rinsing partial loads which will be washed later. *Do not use detergent.* Do not use **DELAY START** with this cycle.

To **change a setting**, just touch desired pad.

Your dishwasher is now automatically programmed including a Soil Level Selection. Cycle Indicator Lights tell you the complete program. And a number in the **SYSTEMS MONITOR** (at right) will tell you how long the cycle will take. If you're satisfied, just touch the **START** pad.

STEP 4

Select a soil level

If you wish to make program changes, start with the soil level. You should select a change within 30 seconds, otherwise all panel lights will go out. To relight, touch any pad or open and **re-close** door.

- **MEDIUM SOIL** is automatically programmed when a cycle is selected. You may want to change the selection depending on the soil on your dishes.
- **HEAVY SOIL** should be selected when dishes are extra soiled or extra greasy. This gives dishes an extra rinse in every cycle except **RINSE & HOLD**. This lengthens cycle.
- **LIGHT SOIL** will save time and money if you pre-rinse your dishes. This shortens all cycles except **RINSE & HOLD**.

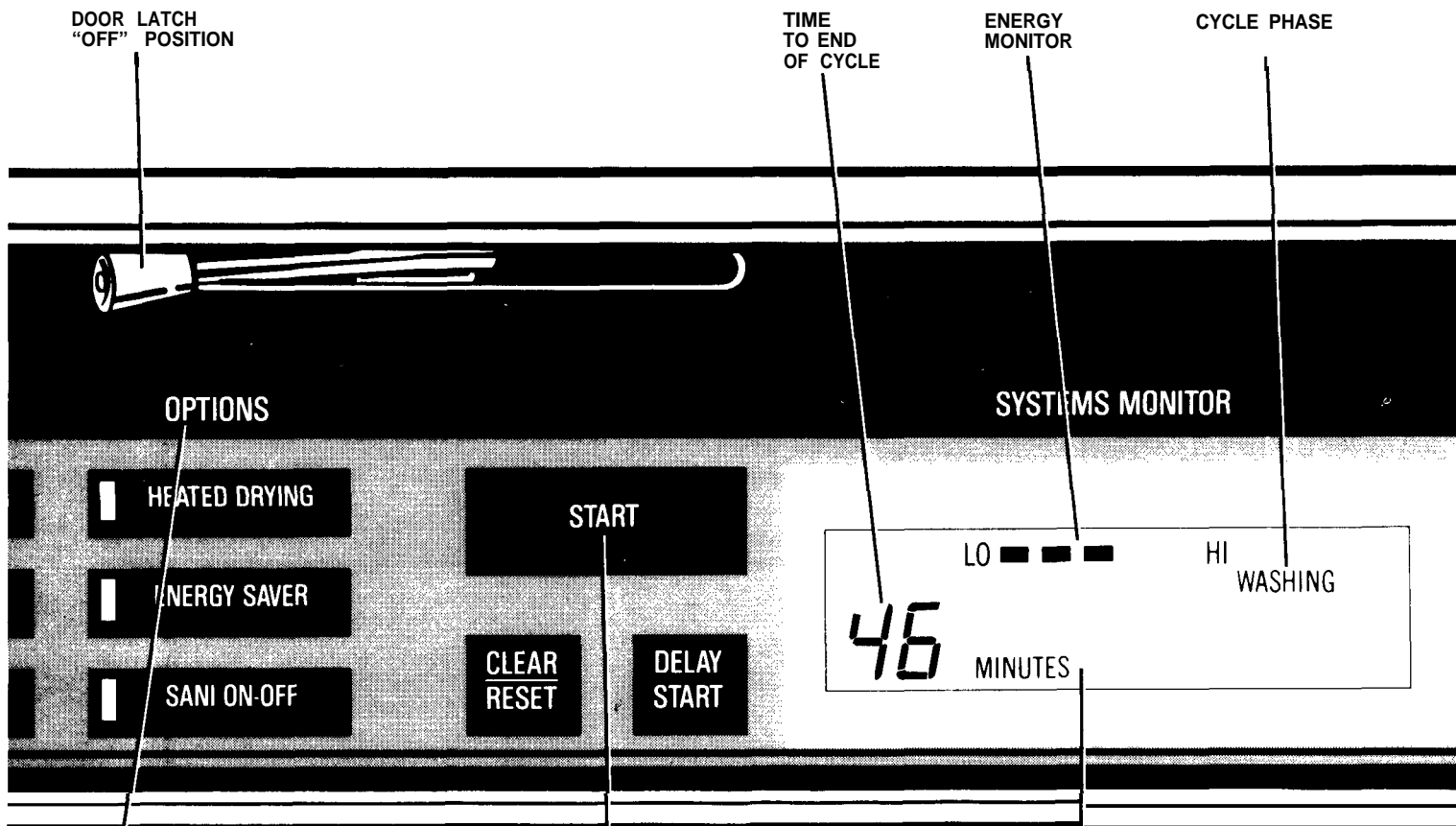

STEP 5

Select an option

- **HEATED DRYING** provides faster drying. Can be changed while cycle is running.
- **ENERGY SAVER** shuts off drying heater. Dishes air-dry naturally. It takes longer, but saves energy. You can prop door open about 3 inches after motor stops to speed drying. Excellent for overnight drying.
- **SANI ON-OFF**. Select with either POTS & PANS or NORMAL WASH. Heats water in final rinse to 140 °145°F. Touch pad once for ON, once more for OFF. This option may be changed at any time before or after start of cycle.

STEP 6

Start the dishwasher.

- When you're ready to wash dishes, touch the **START** pad. Dishwasher will proceed through your entire program and turn off automatically.
- To delay the start**, touch **DELAY START** pad. The **SYSTEMS MONITOR** will read "1 hrs delay." Touch pad once again for each hour desired up to 9 hours. The machine will count down and start automatically at the correct time. Note: Don't forget to put detergent in cup and close cup. Do not use **DELAY START** with the **RINSE & HOLD** cycle.
- To change a cycle after washing starts**, touch the **CLEAR/RESET** pad to cancel cycle. After water is pumped out and motor stops, you can reprogram and restart the dishwasher.

Systems Monitor

This panel tells you what is happening in the dishwasher and can alert you to some possible problems.

Information displayed:

- Selected wash cycle
- Selected dry option
- Minutes to end of cycle
- Cycle phase, such as **WASHING**, **RINSING** or **DRYING**
- Diagnostic codes to alert you to possible problems
- Relative energy used by each cycle. Lets you choose the cycle you need that uses the least energy.

See pages 7-10 for explanation of displays and codes.

Dishwashing shortcut

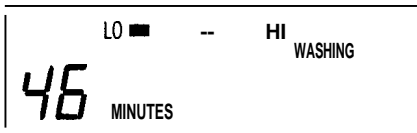

The dishwasher remembers your last cycle so you don't have to reprogram each time.

When the dishwasher is loaded and the door latch is moved to the ON position, the control panel will display the last settings you selected.

If you don't want to change any of the settings, simply touch START.

Note: If there has been a power failure, NORMAL WASH, MEDIUM SOIL and HEATED DRYING will automatically be programmed. Make any new selections as desired and touch START.

How to lock dishwasher controls to prevent use by children

Your dishwasher has a "hidden" control pad. When this pad is touched twice within 3 seconds, all pads become inoperative and no new selections can be made until the lock is released. The word LOCKED appears in the SYSTEMS

MONITOR. Children cannot accidentally start dishwasher by touching pads. The only control unaffected is the DELAY START. If this selection has been made, dishwasher will start automatically after whatever delay you have selected.

Touch here twice within 3 seconds to lock or unlock the control panel.

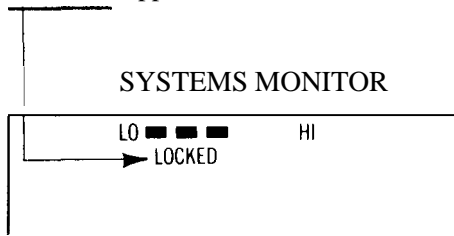

If cycle is interrupted dishwasher reminds you to relatch door





You may want to stop the dishwasher to add an extra dish. . .or for some other reason. If you do and you forget to relatch door the dishwasher will "beep" three minutes later to remind you that the door is not latched. The "beep" will repeat at three-minute intervals until the door is relatched. Dishwasher will not complete cycle until door is properly closed.

The SYSTEMS MONITOR tells you what's happening

DISPLAY	WHAT IT MEANS
NUMERALS FROM 1 to 99 MINUTES	Number of minutes left in the cycle.
NUMERALS FROM 1 to 9 HRS. DELAY	Number of hours delay until start of cycle.
ENERGY MONITOR LO - - - - -HI	Shows relative amount of energy used from LO (one bar lighted) to HI (all five bars lighted).
ENERGY SAVER	Indicates energy-efficient selection made such as SHORT WASH, LIGHT SOIL or ENERGY SAVER (UNHEATED) drying.
WASHING	Displayed during Pre-wash, Pre-rinse and Main Wash periods.
RINSE	Displayed during Rinse periods following the Main Wash.
DRYING	Indicates HEATED DRYING has been selected.
RINSED ONLY	Indicates completion of RINSE& HOLD cycle. Remains on until door is unlatched.
HEATING	Indicates water is being heated—in wash or rinse period—to temperature necessary for good washability. The minutes countdown is on hold for up to a maximum of 20 minutes when HEATING is displayed.
PLUS HEATING	Indicates SANI ON option was selected prior to start of cycle. Cycle time maybe increased (up to a maximum of 20 minutes) to heat final rinse water to 145°F.
CLEAN	Indicates completed cycle (except RINSE & HOLD). Remains on until door is unlatched.
LOCKED	Indicates controls are locked to prevent unauthorized use. See page 6.

The SYSTEMS MONITOR tells you if certain things are wrong

DISPLAY	WHAT IT MEANS	WHAT TO DO
	Electrical power has been interrupted to the dishwasher but is now back on.	<p>IF DISHWASHER WAS IN USE WHEN THE POWER FAILURE OCCURRED:</p> <ol style="list-style-type: none"> 1. Unlatch the door. If the detergent cup is open, add detergent and close the cup. 2. Relatch the door and touch “START” then immediately touch “CLEAR/RESET?” (This will pump any remaining water out of the machine.) 3. Select the desired cycle and rerun the load. <p>IF DISHWASHER WAS <i>NOT</i> IN USE:</p> <ol style="list-style-type: none"> 1. Latch door. 2. Select desired cycle. 3. Run cycle when desired.
CUP OPEN	The detergent cup was open at the start of a cycle.	<ol style="list-style-type: none"> 1. Unlatch the door and add detergent if spilled. 2. Close cup. 3. Latch door and select cycle. 4. Touch “START” <p>NOTE: If cup is latched properly and “CUP OPEN” repeats you may start wash cycle by pressing START pad a second time.</p>
BLOCKED WASH ARM	An obstruction is preventing the lower wash arm from turning. This is usually caused by a utensil sticking through the bottom of the silverware basket or a pot handle through the lower rack.	<ol style="list-style-type: none"> 1. Unlatch door. 2. Check the lower rack for any item that could block the wash arm and reposition it. 3. Relatch door. <p>NOTE: If the wash arm is not blocked and “BLOCKED WASH ARM” display still appears, you may start wash cycle by pressing START pad a second time.</p>
BLOCKED DRAIN	The dishwasher is taking longer than normal to drain the water out. This is usually caused by a blockage in the drain air gap (see page 21), a kink in the drain hose, or a stopped up drain pipe.	<p>This dishwasher is designed to automatically compensate for longer than normal drain times, but cycle time will be extended. If this code continues to appear frequently then:</p> <ol style="list-style-type: none"> 1. Clean the air gap (see page 21). 2. Check for a kink in the drain hose. 3. Check plumbing for slow or stopped up drains. (NOTE: Warranty service does not cover household drain problems.)

DISPLAY	WHAT IT MEANS	WHAT TO DO
<p>BLOCKED DRAIN and </p>	<p>Similar to blocked drain as explained on page 8, but the C2 indicates that the drain is so clogged that the dishwasher cannot continue to operate in a satisfactory manner. Dishwasher will stop.</p>	<p>Locate and remove the blockage in the drain system as explained on page 8. To pump any remaining water out of the machine:</p> <ol style="list-style-type: none"> 1. Latch door. 2. Select any cycle. 3. Touch "START" and then immediately touch "CLEAR/RESET." (NOTE: Warranty service does not cover household drain problems.)
<p></p>	<p>Dishwasher will not go into a drain out period. Dishwasher will stop.</p>	<p>Restart the cycle. If C3 repeats, call for service.</p>
<p></p>	<p>There is too much water in the dishwasher. If C4 appears after a power failure, this is normal and the dishwasher will correct itself.</p>	<p>The dishwasher is designed to automatically pump out extra water as long as the door is latched. When you hear the motor stop running:</p> <ol style="list-style-type: none"> 1. Unlatch the door and see if all the water is gone. (It is normal for a small amount of water to remain in the bottom of tub to keep the water seal lubricated.) 2. If you see water entering the dishwasher, close and latch the door. Shut off the water supply to the dishwasher. 3. If water is gone and no water is entering the dishwasher, restart cycle. 4. If C4 repeats, shut off the water supply to the dishwasher. Call for service.
<p></p>	<p>This can be caused by either of these reasons: Not enough water is entering the dishwasher.</p> <p style="text-align: center;">or</p>	<p>Unlatch the door. If there is no water in the bottom of the dishwasher, check the water supply to the dishwasher.</p> <ul style="list-style-type: none"> ● Is the dishwasher water supply turned on? (Valve usually located under the sink.) ● Is the household water supply turned on? ● If you use well or cistern water, is the supply adequate? <p>If the water supply is adequate, try the cycle again. If C5 repeats, call for service.</p>
	<p>The drain pump could be temporarily blocked (usually caused by food particles such as cereal).</p>	<p>Unlatch the door. If there is standing water in the bottom of the dishwasher, relatch the door. Touch "START," then immediately touch "CLEAR/RESET" to start the pump. If C5 continues to appear, you may need to do this several times to break up the blockage.</p>

(continued on next page)

The SYSTEMS MONITOR (continued)

DISPLAY	WHAT IT MEANS	WHAT TO DO
C6	The water temperature in the dishwasher did not reach the proper wash temperature. This is usually caused by lack of hot water coming from the household water heater.	Avoid showers or laundry just prior to running the dishwasher. (Use the "DELAY START" feature to start dishwasher when the water heater is up to normal temperature.) Adjust household water heater thermostat to 120°F. minimum. If C6 appears nearly every cycle and you know the water from the household water heater is hot (120°F. or more), call for service.
E7	The temperature sensor in the dishwasher is not functioning properly. Dishwasher may continue to be used, but it will not heat water automatically.	The temperature sensor needs to be replaced. Call for service. NOTE: You may continue to use your dishwasher. For best results, adjust your household water heater thermostat to 140°F.
E8	The detergent cup did not open. This is usually caused by a utensil or dish.	<ol style="list-style-type: none"> 1. Unlatch and open the dishwasher door. 2. Check for utensils and dishes that could have blocked the detergent cup from opening. Rearrange if necessary. 3. Close and relatch the door. Wait for 30 seconds. This will allow time for the cup to open by itself. 4. If the detergent cup is still closed, open it by hand and remove the old detergent. See page 13.

Before you call for service

- Try the cycle again to see if the Code reappears. The dishwasher may correct itself.
- Electronic controls can be affected by outside interference.
 - . Sometimes shutting off the power to the dishwasher (at the fuse or circuit breaker) will correct the problem.
- Restore power after about five seconds and try the cycle again.
- Check the guide on pages 8-10 for things you can do to correct the problem.

What happens in each cycle

. You'll hear occasional clicking sounds:

-Soft food disposer shredding action.

-Drain valve opening to pump water out.

-Detergent cup opening.

. The motor stops during drying.

. Water vapor comes through the vent by the door latch during drying and when water is being pumped out.

Wash Cycles	Water Use (Approx.) Gallons			Cycle Sequence						Wash Cycle Time (Approx.) Minutes		
	Heavy Soil	Med. Soil	Light Soil	Pre-Wash/Pre-Rinse	Pre-Rinse	Pre-Rinse	Main Wash	Rinse	Rinse	Heavy Soil	Med. Soil	Light Soil
POTS & PANS	11	10.3	8.9	Pre-Wash/Pre-Rinse	Pre-Rinse	Pre-Rinse	Main Wash	Rinse	Rinse	6'	6'	6'
NORMAL WASH	11	10.3	8.9	Pre-Wash/Pre-Rinse	Pre-Rinse	Pre-Rinse	Main Wash	Rinse	Rinse	6'	46'	4'
SHORT WASH	10.2	8.9	7.2	Pre-Rinse	Pre-Rinse	Main Wash	Rinse	Rinse	Rinse	38	33	28
CHINA CRYSTAL	7.7	4	5.1	Pre-Rinse	Pre-Rinse	Main Wash	Rinse	Rinse		4	40	3
RINSE & HOLD		3.4		Pre-Rinse	Pre-Rinse							12

*Unextended times. These cycle times may be increased up to 20 minutes if necessary for your dishwasher to heat the water to proper temperature for good washability. If SANI OPTION is selected time maybe further extended until water temperature reaches 140° to 145°F. in final rinse.

Drying Cycle Options:

HEATED DRYING. Available on all wash cycles except RINSE& HOLD. Add 34 minutes to wash cycle time.

ENERGY SAVER drying. Drying heater is turned off. Dishes dry naturally.

Temperature Sensor System

To get dishes clean and dry you need hot water. To help you get water of the proper temperature, your dishwasher has a water heating feature that automatically senses the temperature of the water in the wash cycle and heats it, if necessary, to the proper temperature. This water heating feature may allow you to turn down your household water heater and save energy if you're willing to let the dishwasher run a little longer while it heats water to the proper temperature. For good washing and drying, the entering water must be at least 120°F. To prevent dish damage, inlet water should not exceed 150°F.

How to test water temperature:

Check your water temperature inside your dishwasher with a candy or meat thermometer.

Let the dishwasher run through one fill and pump out cycle, then let the dishwasher fill with water the second time.

When you hear the water stop filling, unlatch the door and slowly open it.

Measure the temperature of the water in the bottom of the tub this way:

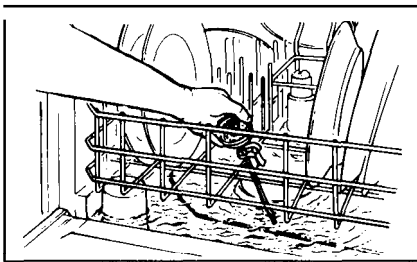

Remove the silverware basket and place a candy or meat thermometer in the water towards the middle of the tub. If the temperature is less than 120°F, you will not get good washing results. Higher water temperature is needed to dissolve grease and activate powder detergents.

Helpful hints: If outside temperatures are unusually low, or if your water travels a long distance from water heater to dishwasher, you may need to set your water heater's thermostat up. If you have not used hot water for some time, the water in the pipes will be cold. Turn on the hot water faucet at the sink and allow it to run until the water is hot. Then start the dishwasher. If you've recently done laundry or run hot water for showers, give your water heater time to recover before operating the dishwasher.

To improve washability if the water is less than 120°F and you cannot adjust your water heater: Select a longer cycle and fill both detergent cups at least half-full with detergent.

How to use a rinse agent.

A rinse agent makes water flow off dishes quicker than usual. This lessens water spotting and makes drying faster, too.

For best dishwashing performance, use of a rinse agent such as JET-DRY brand is recommended.

Rinse agents come in either liquid or solid form. Your dishwasher's dispenser uses the liquid form.

How to fill the rinse agent dispenser. Unscrew the cap. Add the liquid rinse agent until it just reaches the bottom of the lip inside the dispenser opening. Replace the cap. The dispenser automatically releases the rinse agent into the final rinse water.

If you accidentally spill: Wipe up the rinse agent with a damp cloth. Don't leave the spill in the dishwasher. It can keep your detergent from working.

If you can't find any rinse agent, write:

BENCKISER CONSUMER PRODUCTS, INC.
("JET DRY")

411 W. Putnam Ave.
Greenwich, CT 06830

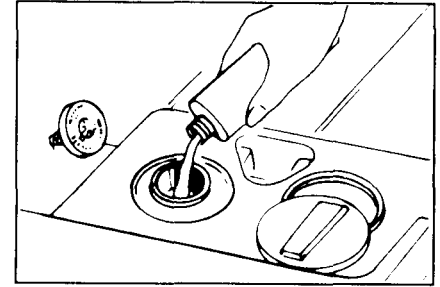

Your dishwasher's rinse agent container holds 4½ ounces. This should last about 3 months. Fill as needed. Do not overfill.

How to choose and use detergent.

First, use only powder or liquid detergents specifically made for use in dishwashers. Other types will cause oversudsing.

Second, check the phosphate content. Phosphate helps prevent hard-water materials from forming spots or film on your dishes. If your water is hard (7 grains or more), your detergent has to work harder. Detergents with a higher phosphate level will probably work better. If the phosphate content is low (8.7% or less), you'll have to use extra detergent with hard water.

Your water department can tell you how hard your water is. So can your county extension agent. Or your area's water softener company. Just call and ask them how many "grains of hardness" there are in your water.

How much detergent should you use? That depends. Is your water "hard" or "soft"? With hard water, you need extra detergent to get dishes clean. With soft water, you need less detergent.

Too much detergent with soft water not only wastes money, it can be harmful. It can cause a permanent cloudiness of glassware, called "etching." An outside layer of glass is etched away! Of course, this takes some time. But why take a chance when it's easy to find out the hardness of your water.

Keep your detergent fresh and dry. Under the sink isn't a good place to store detergent. Too much moisture. Don't put powder detergent into the dispenser until you're ready to wash dishes, either. (It won't be fresh OR dry.)

If your powder detergent gets old or lumpy, throw it away. It won't wash well. Old detergent often won't dissolve.

If you use a liquid dishwasher detergent, these precautions are not necessary because liquid detergents don't "lump" as they age or come in contact with water.

You'll find two detergent dispensers on the inside door of your dishwasher. Two, because some cycles use two washes.

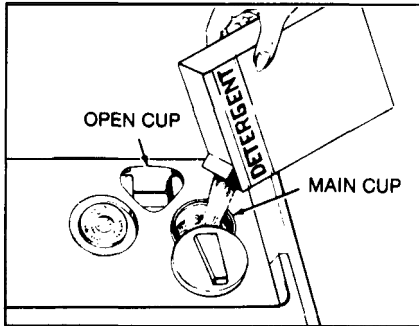

See "Detergent Usage Guide" below.

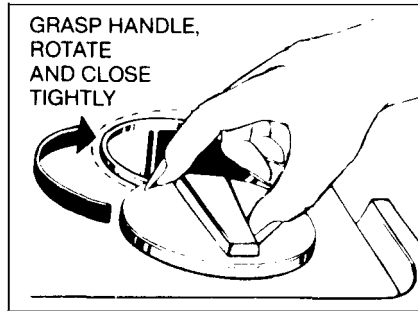

Always close the main cup tightly. When it is firmly latched you will hear a clicking sound. It is not necessary to overtighten.

NOTE: Detergent cup maybe opened manually with no harm. Turn handle counterclockwise until it releases. A snapping sound is normal when it opens.

How to prepare the dishes for washing

If this is your first dishwasher, or if you're replacing a much older model, you may wonder how much pre-preparation your dishes need. Actually very little. Pre-rinsing of normal food soils is not necessary. With common sense and a little practice you'll soon know what foods to remove. Here are some guidelines:

1. Scrape off bones, seeds, skins, toothpicks and other hard solids. It is also best to remove hard shelled vegetables, meat trimmings, leafy vegetables and crusts. Remove excessive quantities of oil or grease.

2. Remove large quantities of any food. Your dishwasher has a built-in soft food disposer that pulverizes soft food bits and flushes them away. It can handle *small* amounts of soft foods, but large amounts will be difficult to handle.

3. Try to remove food scraps and place dishes in dishwasher before soil has a chance to dry and become hard. Dishes with dried-on soil are more difficult to wash and may not come clean in the NORMAL WASH cycle. Remember to use your RINSE & HOLD cycle for small "holding" loads.

Note: The foods mentioned above are for examples only. Other foods not mentioned may also need to be removed from your dishes. You may also want to consider removing foods such as mustard, mayonnaise, vinegar, lemon juice and other foods that can cause discoloration of stainless steel if allowed to remain on dishes for a long period of time.

When using the POTS & PANS cycle, less preparation is required before loading. The POTS & PANS cycle can wash heavily-soiled dishes and remove dried-on and baked-on soils from pots, pans and casseroles. Items with burned-on soils may not come clean. And the dishwasher cannot remove burn marks or restore fading caused by overheating during cooking.

Detergent Usage Guide (powder or liquid)

CYCLES	SOFT WATER (0-3 grains hardness)		MEDIUM WATER (3-7 grains)		HARD WATER (7-12 grains*)	
	Main Cup	Open Cup	Main Cup	Open Cup	Main Cup‡	Open Cup‡
POTS & PANS and NORMAL WASH cycles	1 Tablespoon minimum	+ 1 Tablespoon minimum	Half Full	+ Half Full	Completely Full	+ Completely Full
CHINA-CRYSTAL and SHORT WASH cycles	1 Tablespoon minimum	None	Half Full	None	Completely Full	None
RINSE & HOLD cycle	Use no detergent		Use no detergent		Use no detergent	

*12 grains and up is extremely hard water. A water softener is recommended. Without it, lime can build up in the water valve. The water valve may stick while open and cause flooding.

‡Filled Main Cup holds 3 tablespoons; Filled Open Cup holds 2 tablespoons.

How to load your dishwasher

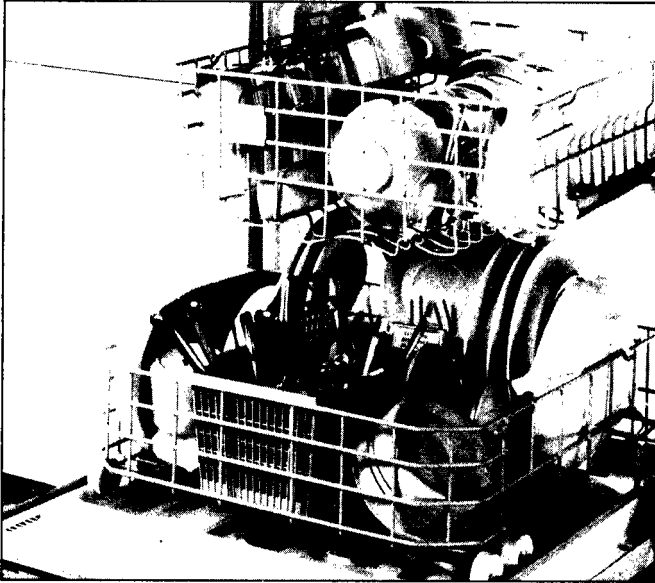

This is a random mixed load, the most common type you will have.

Make sure dishes are properly loaded to insure that water can reach the soiled surfaces. The wash arm in the bottom sprays water up. The tower that rises in the center sends water out over the dishes to wash the items in the upper rack. On some models, a spray arm in the top washes down also. Make sure to place tall items to the outside so the upper wash arm is not blocked.

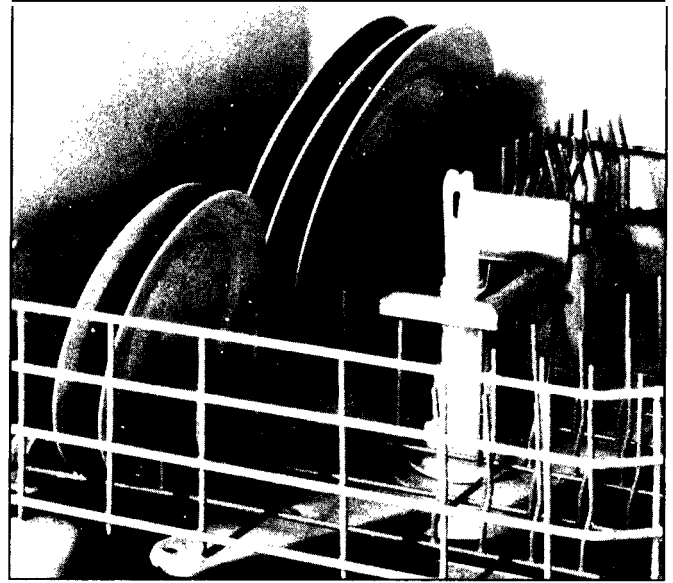

WATCH OUT FOR THIS.

The washer tower rises through the center of the bottom rack during the wash and rinse portions of the cycle. Don't block it or load tall things next to it. Also, be careful not to let a portion of an item such as a pot or dish handle extend through the bottom rack. This could block the wash arm and cause poor washing results.

How to load the TOP RACK

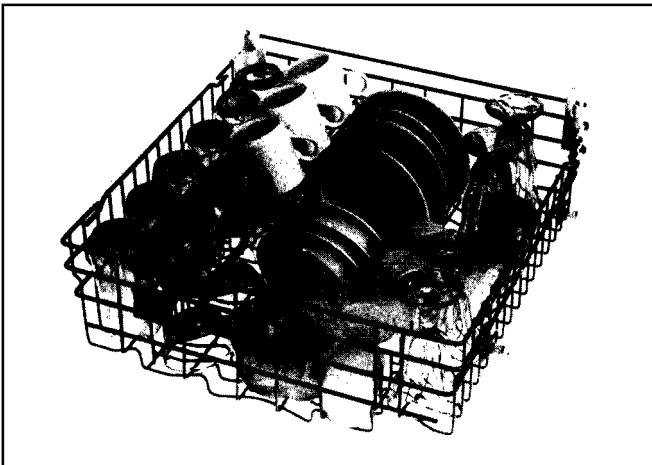

The top rack is best for glasses, cups and saucers. Two rows of cups can be washed when using the folding shelf. Load the bottom row first, then fold down the shelf and load the top row. Cups and glasses fit best along the sides. This is the place for dishwasher-safe plastics, too. Make sure small plastic items are lodged in tightly so they can't fall onto the Calrod® heating unit. Arrange stemware so that it cannot move easily. Don't let the glasses touch each other.

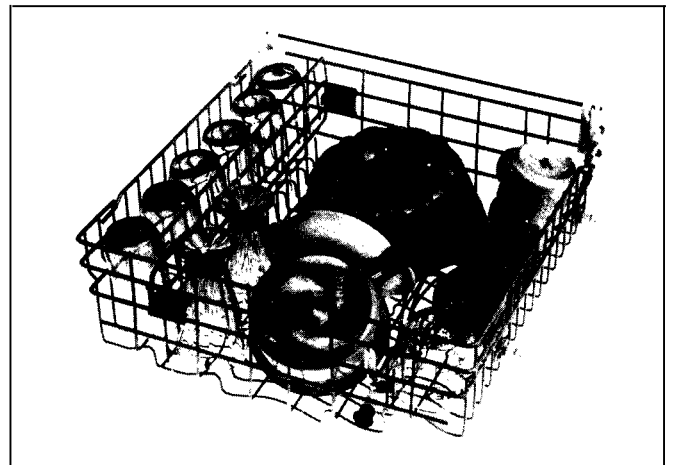

Sauce pans, mixing bowls and other small items may be placed—face down—in this top rack. The top rack is handy for all kinds of odd shapes.

How to load the TOP RACK (continued)



Shelf Up

Fold the folding shelf up for glasses and tall things. Place tall items to the outside so the upper wash arm is not blocked.

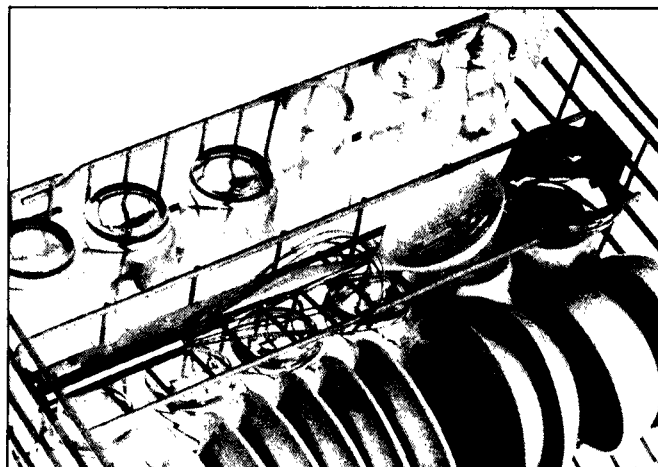

Shelf Down

The folding shelf gives you extra space for cups and long utensils on two levels. Load the lower level first, then fold the shelf down.

How to load the BOTTOM RACK

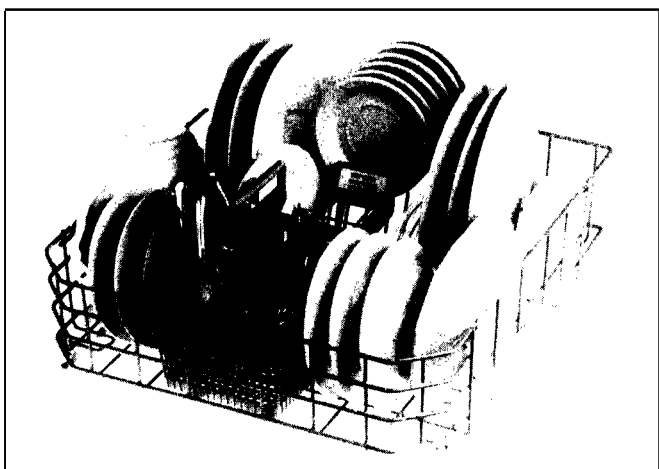

Fit plates and saucers between the pins. Load platters, pots and bowls along the sides, in corners or in the back.

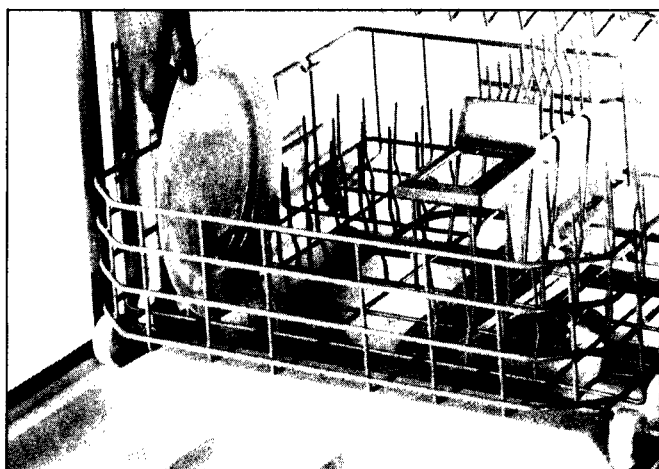

As shown here this plate is being placed with the soiled side facing the center of the rack so water and detergent from wash arm can reach soiled surfaces.

(continued next page)

How to load the BOTTOMRACK (continued)

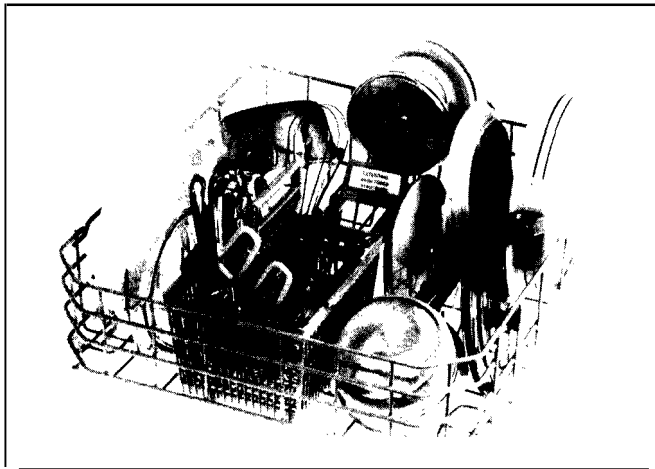

Pots, pans, casseroles, salad bowls, mixing bowls and lids *must* be loaded in the bottom rack, facing down.

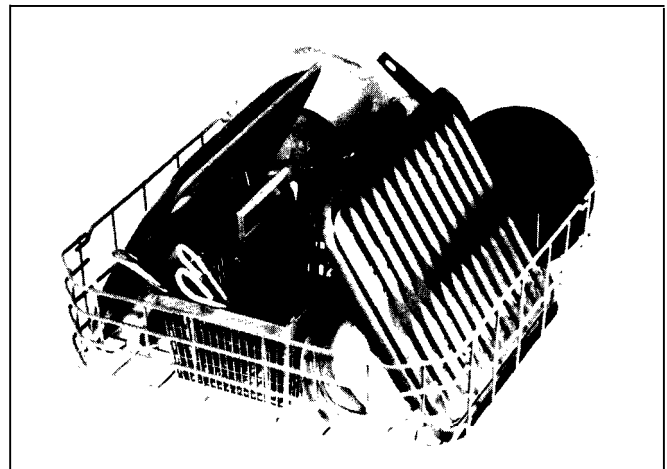

Heavily soiled pots, pans and casseroles **MUST** be loaded in the bottom rack, facing down. Prop broiler pans and racks along the edge. Shallow items may be angled provided the lower side does not shield the soiled surface inside from the water.

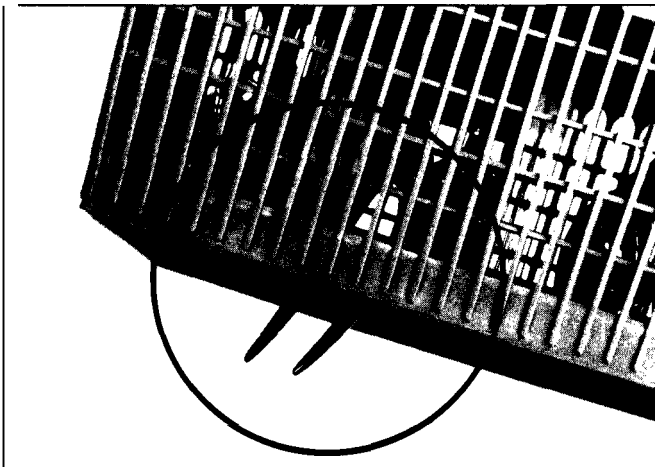

Precaution!

Take out anything that may fall or extend through the bottom of the basket.

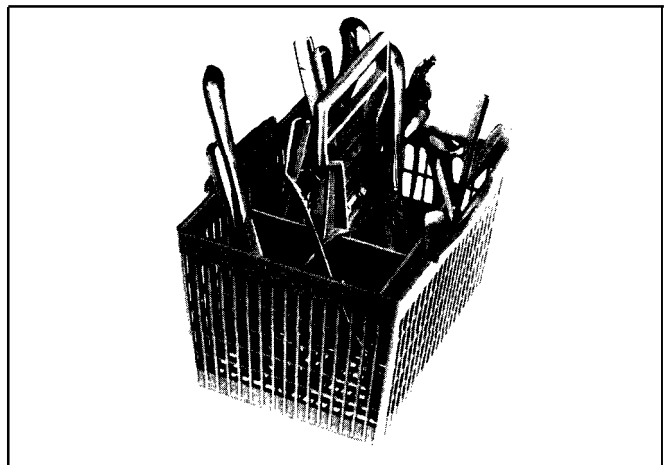

Put flatware in the removable basket with handles up to protect your hands. Mix knives, forks and spoons so they don't nest together. Distribute evenly.

The security cell cover, hinged in the handle, can be lowered to either side to secure light-weight items from the effects of the vigorous wash action. When it is not needed, this cover can remain upright.

What you can usually wash safely in your dishwasher. And what you can't.

Material	Usually Safe	Exceptions (not safe)	Special Instructions
Aluminum	YES	Some colored anodized aluminum can fade.	Some darkening or spotting possible. Remove by scouring with soap-filled steel wool pads.
China/ Stoneware	YES	Antique, metal-trimmed, hand-painted or over-the-glaze patterns fade. Gold leaf will discolor.	If in doubt, check with the manufacturer. Or test wash one piece daily for at least a month. Compare with the rest of the set.
Crystal	YES	Antique, metal-trimmed or hand-painted patterns fade. Gold leaf will discolor.	Load securely to prevent movement. Select CHINA-CRYSTAL cycle. Check your manufacturer's instructions for your crystal.
Non-dishware items—such as electronic air cleaner filters, furnace filters, paint brushes, etc.	NO		Do not wash in dishwasher. Damage to dishwasher and discoloration or staining of dishwasher may result.
Glass	YES	Milk Glass may yellow.	
Iron	NO	Iron will rust.	
Pewter	NO	Pewter tarnishes.	
Plastics	YES		If it doesn't say DISHWASHER SAFE, test one piece in the top rack before dishwashing an entire set.
Stainless steel	YES		Rinse if not washing immediately. Salty or acid foods can stain if left on.
Sterling Silver and Silver plate	YES	Don't put in same silverware basket with stainless steel. Contact between metals can damage silver. Don't wash copper utensils in the same load. Silver may get a brown film. Adhesive used to attach some hollow-handle knives can loosen.	Rinse if not washing immediately. Salty or acid foods can stain if left on. Dry detergent can cause difficult-to-remove black spots. Place in back section of silverware basket to avoid exposure to detergent from the detergent cup.
Non-stick coatings	YES		After washing, wipe the non-stick coating area with vegetable oil to keep it from losing its non-stick quality.
Tin	NO	Tin can rust.	
Wood	NO	Wood can warp, crack or lose its finish with any type washing.	

Forget a dish? Here's when you can add it.

Add dishes any time during the RINSE & HOLD cycle. With other wash cycles, you can add dishes at any time BEFORE the WASHING signal light goes off.

However, opening the door during any cycle lessens cleaning power. So try to load everything at the beginning.

Here's how to add a forgotten dish:

1. Push the door latch to the left. Washing will stop.

2. Wait a few seconds until the water calms. Then open the door.
3. Add dishes you've forgotten.
4. Close the door and push the latch to the far right. When the door is locked, washing will continue.



Questions? Use This Problem Solver

PROBLEM	POSSIBLE CAUSE AND REMEDY
CONTROL PANEL LIGHTS GO OFF WHEN YOU'RE SETTING CONTROLS	Time too long between touching of selected pads. Each pad must be touched within 30 seconds of the others. To relight, touch any pad again. Or unlock and relatch door.
DISHWASHER WON'T RUN	A fuse in your home maybe blown, or the circuit breaker tripped. Replace fuse or reset circuit breaker, Remove any other appliances from the circuit.
UNUSUAL NOISE	Utensils may not be secure on rack pins, or something small may have dropped from the rack. Water is causing utensils to rattle. Make sure everything is securely placed in dishwasher. Water draining out of tub immediately after you touch CLEAR/RESET pad. The sounds you hear are normal ones.
DISHES DON'T DRY	Make sure inlet water temperature is correct. (See page 12.) Unload the bottom rack first. Water from dishes in the top rack maybe spilling into the bottom rack . Check for improper loading. Dishes shouldn't nest together. Avoid overloading. Check the rinse agent dispenser to see that it's not empty.
UNCLEAN DISHES AND FLATWARE	Check inlet water temperature. It should be at least 120°F . (To test, see page 12.) Water pressure may be temporarily low. Turn on a faucet. Is water coming out slower than usual? If so, wait until pressure is normal before using your dishwasher. Plugged air gap. (See page 21.) Improper rack loading. (See pages 14-16.)
BLACK OR GRAY MARKS ON DISHES	Aluminum deposits often leave marks when they rub against other things. Remove marks with a mild abrasive cleanser.
DETERGENT LEFT IN DISPENSER CUPS	Water may not be reaching the detergent cups. Move dishes that maybe blocking the detergent cup. The dispenser cover may not be opening or may be blocked by improperly loaded items. If you used a powder detergent, open the cup and remove any caked-on detergent. If the cup still doesn't open automatically, call for service. Detergent may be old. If the powder detergent is hard or caked in the box, throw it away. The detergent may not be working well. Try another brand.

PROBLEM	POSSIBLE CAUSE AND REMEDY
<p>SPOTS AND FILMING ON GLASSES AND FLATWARE</p>	<p>Spotting can be caused by all these things:</p> <ul style="list-style-type: none"> ● Extremely hard water. (See page 12.) ● Low inlet water temperature. (To test, see page 12.) ● Overloading the dishwasher. ● Improper loading. (See pages 14-16.) ● Old or damp powder detergent. ● Phosphate level in detergent too low. (See page 12.) ● Rinse agent dispenser empty. (See page 12.) ● Too little detergent. (See page 13.) <p>Due to varying local water conditions and personal preferences, try several brands of detergents to find one that gives the best results for you. A liquid dishwasher detergent may help reduce filming.</p> <p>To remove spots and film from glassware:</p> <ol style="list-style-type: none"> 1. Remove all metal utensils from the dishwasher. 2. DO NOT ADD DETERGENT. 3. Select POTS & PANS cycle, LIGHT SOIL and ENERGY SAVER drying. 4. Start the dishwasher and allow to run until “40” minutes to end of cycle is displayed. 5. Then open the door and pour 2 cups (500ml) of white vinegar into the bottom of the dishwasher. 6. Close the door and allow the dishwasher to complete the cycle. <p>If vinegar rinse doesn’t work: Repeat as above, except use 1/4 cup (60ml) of citric acid crystals instead of vinegar. (Most drugstores carry citric acid crystals. If yours doesn’t, call Hotpoint Factory Service.)</p> <p>Using a vinegar or citric acid crystal rinse more than twice a month? Consider a home water softener.</p>
<p>CLOUDINESS ON GLASSWARE</p>	<p>If vinegar or citric acid crystal rinse doesn’t work, the cloudiness is “etching.” The film cannot be removed.</p> <p>It can be prevented: Use less detergent if you have soft water. Wash glassware in the shortest cycle that will get them clean,</p> <p>Water temperature entering dishwasher exceeds 150°F.</p>
<p>YELLOW OR BROWN FILM</p>	<p>Tea or coffee can stain cups. Remove the stains by hand, using a solution of 1/2 cup bleach and 3 cups warm water.</p> <p>An overall yellow or brown film on dishes or glassware can be caused by iron deposits in water. A special filter in the water supply line is the only way to correct this problem. Your water softener company can tell you about the filter.</p> <p>Yellow film on sterling silver results when you wash copper utensils in the same load. Silver polish will usually remove this stain.</p>

(continued on next page)

The Problem Solver (continued)

PROBLEM	POSSIBLE CAUSE AND REMEDY
CHIPPING OF CHINA	<p>Rough handling can cause chipping. Load with care. Make sure glassware and china are secure and can't jar loose. (See pages 14 and 15 for correct way to load glassware.) Make sure tall glasses and stemware will clear the top of the tub when you push the rack into the dishwasher. Always use the top rack for delicate items.</p> <p>Use the CHINA-CRYSTAL cycle for fine china.</p>
SMALL AMOUNT OF WATER STANDING IN THE BOTTOM OF THE TUB	<p>Water around the outlet on the tub bottom at the back of the tub is normal. It is clean water. It's there to keep the water seal lubricated.</p>
WATER WON'T PUMP OUT OF THE TUB	<p>If the entire bottom of the tub has water, you may have a drain problem. Clean the air gap, if you have one. (See page 21.)</p> <p>Check the kitchen sink. Is it draining well? You may need a plumber.</p> <p>If dishwasher drains into a disposer, run the disposer to clear. Be sure the disposer is not clogged.</p> <p>See the SYSTEMS MONITOR (pages 8-10).</p>
SUDS IN THE TUB	<p>Sudsing detergents are not meant for dishwashers. USE ONLY AUTOMATIC DISHWASHER DETERGENTS TO AVOID SUDSING.</p> <p>To remove suds from the tub: Open the dishwasher. Let suds evaporate. Add 1 gallon of cold water to the tub. Close and latch the dishwasher. To pump out water, touch START two times, then immediately touch CLEAR-RESET.</p> <p>Repeat if necessary,</p>
DISHWASHER LEAKS	<p>Suds can cause unit to overflow. That's why it's so important to use a detergent that's designed for automatic dishwashers.</p> <p>Spilling the rinse agent can cause foam during washing. This can lead to overflowing. (Wipe up accidental spill of rinse agent with a damp cloth.)</p>
CONTROL PANEL DOESN'T RESPOND TO INPUTS	<p>Shut off power to dishwasher at fuse or circuit breaker. Wait 5 seconds and restore power to dishwasher. Try input panel again.</p>

If you need more help.. call, toll free:
GE Answer Center®
800.626.2000
consumer information service

Care and Cleaning

USER MAINTENANCE INSTRUCTIONS

Clean the control panel with a **lightly dampened cloth**. Dry thoroughly. Do not use abrasives or sharp objects on the panel. They can damage it.

Clean the outside with a good **appliance polish wax**. The outside cabinet finish is durable, but it can scratch. So use no scouring pads, or harsh or gritty cleaners.

Appliance **Polish Wax & Cleaner** (Cat. No. **WR97X216**) is available from **Hotpoint Appliance Parts Marts**.

The inside usually takes care of itself. If it should ever need cleaning, use a mild cleansing powder. Scouring pads and harsh cleaners can mar the finish.

Built-in dishwashers often use an air gap. Keep it clean

An air gap is a plumbing device. It protects your dishwasher against water backing up into it if a drain clogs. The air gap is not a part of the dishwasher. And you may not even have one. Not all plumbing codes require air gaps.

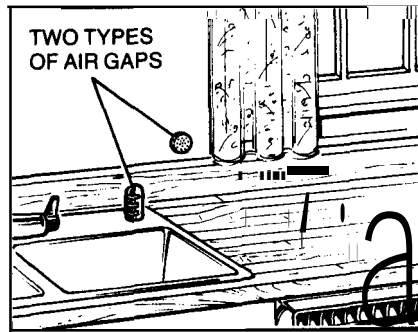

If you have an air gap, check it at least once a month. **IT IS NOT PART OF YOUR DISHWASHER. IT IS NOT COVERED IN YOUR WARRANTY.**

The air gap is easy to clean.

With most types, first turn off the dishwasher, then lift off the chrome cover. Then unscrew the plastic cap and check for any buildup of grit. A toothpick makes cleaning easy.

Check the air gap any time your dishwasher isn't draining well.

Not using your dishwasher in winter? Protect against freezing.

If your dishwasher is left in an unheated place during the winter, ask a service technician to:

- Cut off electric power to the dishwasher. Remove fuses or trip circuit breaker.
 - Turn off the water supply.
 - Disconnect the water inlet line from the water valve.
 - Drain water from the inlet line and water valve. (Use a pan to catch the water.)
 - Reconnect the water inlet line to the water valve.
- Remove the plug in the bottom of the rubber boot. Drain completely, then reinstall plug and clamp.
- Drain the collection chamber at rear of unit below filter by disconnecting hose to pump. Reconnect after draining.

How to change color panels

If you are redecorating, you can change your dishwasher's front panels to match or blend with your new colors.

The panels are held in place by the door trim and the trim on the panel below the door. Each side of each panel is a different color. Or you can paint a panel with the color of your own choice.

How to change door panel inserts:

1. Take out three trim screws on either side of the dishwasher door. Remove the side trim.
2. Slide out both insert panels together.
3. Put the color you want in front. (Careful—edges may be sharp.)
4. Replace insert panels, side trim and screws.

How to change lower panel inserts:

1. Remove four panel attachment screws. (Two above the panel, two below the panel.)
2. Remove the entire panel.
3. Take out three screws and remove the top trim.
4. Slide out both insert panels together.
5. Put the color you want in front.
6. Replace insert panels, top trim and screws.
7. Replace the entire panel and four attachment screws.

Color insert panels for both door and panel can be replaced by 1/4" thick wood inserts to match your kitchen cabinets. Get them from your nearest cabinet or lumber dealer.

Dimensions for 1/4" wood inserts:

Door Panel: 19¹/₈" H x 23⁹/₁₆" W.

Lower Panel: 3¹¹/₁₆" H x 23⁹/₁₆" W.

Note: Do not operate dishwasher while changing panels or when lower access panel is removed.

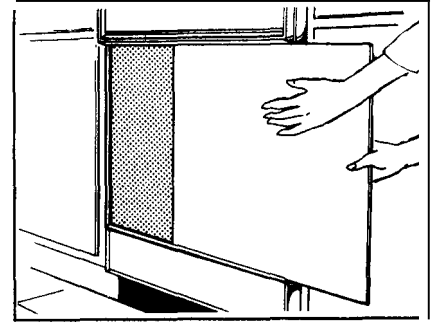

Change color in minutes. Just remove trim and change.

If You Need Service

To obtain service, see your warranty on the back page of this book.

We're proud of our service and want you to be pleased. If for some reason you are not happy with the service you receive, here are three steps to follow for further help.

FIRST, contact the people who serviced your appliance. Explain why you are not pleased. In most cases, this will solve the problem.

NEXT, if you are still not pleased, write all the details—including your phone number—to:

Manager, Consumer Relations
Hotpoint
Appliance Park
Louisville, Kentucky 40225

FINALLY, if your problem is still not resolved, write:

Major Appliance
Consumer Action Panel
20 North **Wacker** Drive
Chicago, Illinois 60606

YOUR HOTPOINT AUTOMATIC DISHWASHER WARRANTY

Save proof of original purchase date such as your sales slip or cancelled check to establish warranty period.

WHAT IS COVERED

FULL ONE-YEAR WARRANTY

For one year from date of original purchase, we will provide, free of charge, parts and service labor in your home to repair or replace **any part of the dishwasher** that fails because of a manufacturing defect.

FULL TEN-YEAR WARRANTY

For ten years from date of original purchase, we will provide, free of charge, parts and service labor in your home to repair or replace **the tub or door liner** if it fails to contain water because of a manufacturing defect such as cracking, chipping, peeling or rusting.

LIMITED SECOND-YEAR WARRANTY

For the second year from date of original purchase, we will provide, free of charge, replacement parts for **any part of the Water Distribution System** (as illustrated below) that fails because of a manufacturing defect. Associated inlet and drain plumbing parts are not covered by this warranty. You pay for the service trip to your home and service labor charges.

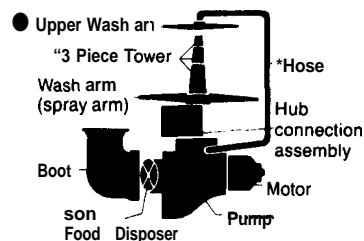

Water Distribution System

This warranty is extended to the original purchaser and any succeeding owner for products purchased for ordinary home use in the 48 mainland states, Hawaii and Washington, D.C. In Alaska the warranty is the same except that it is LIMITED because you must pay to ship the product to the service shop or for the service technician's travel costs to your home.

All warranty service will be provided by our Factory Service Centers or by our authorized Customer Care[®] servicers during normal working hours.

Look in the White or Yellow Pages of your telephone directory for HOTPOINT FACTORY SERVICE, GENERAL ELECTRIC-HOTPOINT FACTORY SERVICE or HOTPOINT CUSTOMER CARE[®] SERVICE.

WHAT IS NOT COVERED

• Service trips to your home to teach you how to use the product.

Read your Use and Care material.

If you then have any questions about operating the product, please contact your dealer or our Consumer Affairs office at the address below, or call, toll free:

GE Answer Center[®]
800.626.2000
consumer information service

• Improper installation.

If you have an installation problem, contact your dealer or installer. You are responsible for providing adequate electrical, plumbing and other connecting facilities.

• Replacement of house fuses or resetting of circuit breakers.

• Cleaning or servicing of air gap device in drain line.

• Failure of the product if it is used for other than its intended purpose or used commercially.

• Damage to product caused by accident, fire, floods or acts of God.

WARRANTOR IS NOT RESPONSIBLE FOR CONSEQUENTIAL DAMAGES.

Some states do not allow the exclusion or limitation of incidental or consequential damages, so the above limitation or exclusion may not apply to you. This warranty gives you specific legal rights, and you may also have other rights which vary from state to state. To know what your legal rights are in your state, consult your local or state consumer affairs office or your state's Attorney General.

Warrantor: General Electric Company

If further help is needed concerning this warranty, write:
Manager—Consumer Affairs, GE Appliances, Louisville, KY 40225

Part No. 165D3080P070
Pub No. 39-5189

HOTPOINT

HDA2600K

Free Manuals Download Website

<http://myh66.com>

<http://usermanuals.us>

<http://www.somanuals.com>

<http://www.4manuals.cc>

<http://www.manual-lib.com>

<http://www.404manual.com>

<http://www.luxmanual.com>

<http://aubethermostatmanual.com>

Golf course search by state

<http://golfingnear.com>

Email search by domain

<http://emailbydomain.com>

Auto manuals search

<http://auto.somanuals.com>

TV manuals search

<http://tv.somanuals.com>