

Studio Collection

 **Hotpoint**

Our ideas. Your home.



Sophisticated technology.  
Intelligent features. Stylish  
design. All this and more  
in our Studio Collection.  
Our ideas. Your home.

Inspired by you, we've developed an exclusive collection of appliances utilising the best technology to provide intelligent features all wrapped up in a stunning design. Intelligent Cooking programmes and self cleaning Pyrolytic options on our ovens, Double Face Elliptical burners on our gas hobs, Super Silent dishwashers and Eco Cycles on our integrated laundry products all complete this sophisticated range.





Ovens

Stylish ovens helping you achieve professional results every time.

10



Hobs

A choice of gas, induction or ceramic hobs to suit your cooking style.

16



Laundry

Save around 50-70% of the energy used with our A rated wash performance Eco Cycles.

26



Hoods

Choice of widths to suit your kitchen.

20



Dishwashers

All our dishwashers are energy efficient, using less water than washing up by hand.

22



Refrigeration

A wide selection of fridges and freezers to suit any kitchen.

30

Specifications

To help design your own stylish kitchen.

38



## Stylish Design

With a focus on smooth curves and meticulous detailing our cooking range aesthetic will complement any kitchen style.



# Intelligent Cooking System

Your ideal kitchen partner, Hotpoint's Intelligent Cooking System features pre-set programmes to help you achieve professional results – every time. Our ideas. Your home.

Ever wanted a top chef to give you their professional help and expertise? We've developed the next best thing... easy to use ovens that manage everything for you. From optimising oven elements, to recommending shelf position, temperatures and cooking time, you can be confident that even the most ambitious gourmet dish will turn out beautifully.



## Intelligent Cooking System

Imagine the aroma of freshly baked bread, the succulence of roasted meats or the lightest sponge cakes that more than rise to the occasion – all cooked to perfection using the Intelligent Cooking System.



## Cake Cycle

A fully automatic cycle sets the temperature and time for baking perfect sponge cakes. Plus, you can prepare tortes and choux pastry precisely, with no pre-heating time required.



## Bread Cycle

A function which sets the optimum temperature and time for proving and baking bread.



## Pizza

Cook a homemade pizza in just 30 minutes. Use the dough recipe supplied to create your own pizza.



## Roast Meat

Any meat can be cooked faultlessly. The oven takes care of the different cooking phases, raising the temperature at the start for browning and cooking the inside, then lowering the temperature and turning the fan on at the end to relax the meat and ensure it doesn't dry out. You can even adjust cooking levels to choose well done, medium or rare.



## Roast Chicken

Roast chicken and poultry to perfection, with the crispiest skin and the most tender meat.



## Fish

Gentle pulses of heat ensure every type of fish is cooked precisely.

# Single Ovens & Double Ovens



## Touch Control

The ultimate in sophisticated technology, our touch sensitive panels deliver precision cooking to your fingertips. The technology offers you total control with ovens that are easy to clean, efficient and a pleasure to use.



## Solarplus High Speed Grill

The Solarplus Grill gets to full temperature after only 15 seconds and it is 20% quicker than a conventional grill. The grill mesh is also practically self-cleaning saving you valuable time and inconvenience.



## Fast Clean – Pyrolytic Cycle

To keep your oven as clean and shiny as the rest of your kitchen, simply use the Fast Clean Pyrolytic Cycle. The triple glazed doors automatically lock, the oven heats to 500°C and burns off all the fat and waste leaving a small deposit of ash for you to simply wipe away. The process is completely safe and costs less than 50p each time!

KSO103P

Touch Control Multifunction Oven



Single Ovens



Take the guesswork out of cooking using our Intelligent Cooking Functions – for the perfect roast, bread, cakes and pizza.



### 10 Cooking Programmes:

4 Intelligent Programmes:

Roast, Bread, Cake, Pizza

6 Standard Programmes:

Circulaire Fan, Fan Grilling, Variable Grill, Low Temperatures 40°C, 65°C & 90°C

1 Standard Light

Fast Clean Pyrolytic Cycle

Total Electronic Control

24 Hour Electronic Programmable Timer with Time and Temperature Control

Triple Glazed Door

Finish: Stainless Steel (X)

KS089C  
Multifunction Single Oven



KS053C  
Multifunction Single Oven



KS033C  
Circulaire Fan Single Oven



 Experiment with confidence using 8 individual cooking programmes. Rustle up a succulent roast, perfect pizza or freshly baked bread.

Multi-Function <b>8</b>	Electronic control CONTROL	Electronic timer 0 1:52	Energy A
----------------------------	-------------------------------	----------------------------	-------------

- 8 Cooking Programmes:**  
Fast Cooking, Fan Grilling, Variable Grill, Circulaire Fan, Pizzas, Pastries, Proving, Conventional
- 24 Hour Electronic Programmable Timer with Time and Temperature Control  
Stay Clean Oven Finish (Catalytic liners)  
Air Flow Cooling Fan & Internal Chimney Venting  
Easy Clean Inner Door Glass  
Triple Glazed Doors

Finish: Stainless Steel (X)

 No need to plan your life around meals with a 24 hour programmable timer.

Multi-Function <b>5</b>	Electronic timer 0 1:52	Energy A
----------------------------	----------------------------	-------------

- 5 Cooking Programmes:**  
Conventional, Circulaire Fan, Fan Grilling, Top Heat Only, Variable Grill
- 24 Hour Electronic Programmable Timer with Time Control  
Stay Clean Oven Finish (Catalytic Liners)  
Air Flow Cooling Fan & Internal Chimney Venting  
Double Glazed Door  
Easy Clean Inner Door Glass

Finish: Stainless Steel (X)

 Hate cleaning? You'll love catalytic liners. Any grease is burned off when the oven reaches 200°C.

Electronic timer 0 1:52	Energy A
----------------------------	-------------

- 3 Cooking Programmes:**  
Circulaire Fan, Fan Grilling, Variable Grill
- 24 Hour Electronic Programmable Timer with Time Control  
Stay Clean Oven Finish (Catalytic Liners)  
Air Flow Cooling Fan & Internal Chimney Venting  
Double Glazed Door  
Easy Clean Inner Door Glass

Finish: Stainless Steel (X)

SHL532  
Side Opening Single Oven



KSD99C  
Multifunction Double Oven



UHS53  
Built-Under Double Oven



MWH121  
Microwave Oven with Defrost Function



Enjoy easier access to your cooking with our side opening oven door.



- 3 Cooking Programmes:**  
 Circulaire Fan, Grill, Defrost  
 24 Hour Programmable Timer with Time Control  
 2 Telescopic Shelves  
 1 Standard Light  
 Easy Clean Enamel Oven Finish  
 Air Flow Cooling Fan  
 Reversible Door  
 Double Glazed Door

Finish: Stainless Steel (X), White (W)

Take the guesswork out of cooking using our Intelligent Cooking Functions – for the perfect roast, bread, cakes and pizza.



- 10 Cooking Programmes:**  
**Main Oven:**  
 5 Intelligent Programmes:  
 Roast Meat, Roast Chicken, Fish, Cakes, Bread  
 3 Standard Programmes:  
 Circulaire Fan, Conventional, Proving  
**Top Oven:**  
 Conventional, Solarplus Twin Variable Grill  
 Electronic Timer with Time and Temperature Control  
 Stay Clean Oven Finish (Catalytic Liners)  
 Lights in Both Ovens  
 Air Flow Cooling Fan and Internal Chimney Venting  
 Triple Glazed Door with Easy Clean Inner Door Glass

Finish: Stainless Steel (X)

In a hurry? Circulaire fan ovens are 20% quicker than a conventional oven.



- Electric Circulaire Fan Oven with  
**5 Cooking Programmes:**  
**Main Oven:** Circulaire Fan, Defrost Setting, Slow Cook Setting (constant 90°C)  
**Top Oven:** Conventional Oven, Twin Variable Grilling  
 Easy Clean Enamel Oven Finish  
 24 Hour Electronic Programmable Timer with Time Control  
 Lights in Both Ovens  
 Air Flow Cooling Fan & Internal Chimney Venting  
 Double Glazed Doors

Finish: Stainless Steel (X)

Keep the sleek look of your kitchen and hide away your microwave in a cupboard with our purpose designed model.

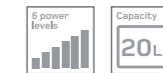

- Builds into a 60cm Wide, 32cm Deep Wall Cupboard  
 Fully Electronic Clock & Timer  
 6 Power Levels  
 4 Automatic Programmes  
 800W Cooking Power

Finish: Stainless Steel (X)



## Gas Hobs & Electric Hobs



### Double Face Burners

The versatile oval burners can be rotated 90 degrees depending on the usage. They can be used together, creating a more even heat distribution beneath large pans such as fish kettles or griddles, or the burners can be used independently as standard burners.



### Triple Ring Wok Burner

The art of stir frying is in the power and heat of the wok burner. This innovative triple ring optimises the power of gas and allows quick and uniform cooking delivering even heat under the pan.



### Benefits of Induction

Fast, energy efficient, clean, safe and controllable. Induction cooking instantly generates heat via a magnetic field only activated by the presence of a pan. Only the cooking zone becomes warm, making cleaning a breeze.

CI0744DO

70cm Touch Control Induction Hob



CI0644DD

60cm Touch Control Induction Hob



Enjoy greater flexibility with the oval dual zone suitable for standard pans or fish kettles.

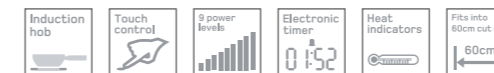

4 Cooking Zones:

- 2 x 1.4kW (with Booster up to 2kW)
- 1 x 2.2kW (Double Ring with Booster up to 3kW)
- 1 x 2.2kW (Oval with Booster up to 3kW)

Child Lock

4 Individual Timers – 1 for each Cooking Zone

Finish: Bevelled (B)



Time your cooking to perfection with 4 individual timers – one for each cooking zone.

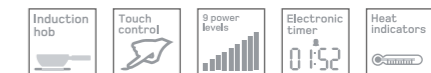

4 Cooking Zones:

- 2 x 1.4kW Zones (with Booster up to 2kW)
- 2 x 2.2kW Zones (with Booster up to 3kW)

Child Lock

4 Individual Timers – 1 for each Cooking Zone

Finish: Profile (Z)

**KSC640**  
60cm Touch Control Ceramic Hob



**GC760F**  
75cm Gas Hob



**GC751T**  
75cm Gas Hob



**KSG641**  
60cm Gas Hob



 Stop meddling hands from adjusting the temperature by using the child lock.



**4 Cooking Zones:**  
1 x 1.2kW Hilight Zone  
1 x 1.4kW Hilight Zone  
1 x 1.8kW Hilight Zone  
1 x 2.3kW Hilight Zone  
Child Lock  
  
Finish: Stainless Steel (X)

 For succulent poached fish use the versatile double face burners to provide even heat under the entire pan.



**6 Gas Burners:**  
2 Double Face, 1 Rapid, 1 Semi-Rapid,  
2 Standard  
Enamelled Pan Supports  
  
Finish: Stainless Steel (X)

 Maximise hob size by choosing a 75cm model which still fits into a standard 60cm cut out on your worktop.



**5 Gas Burners:**  
1 Triple Ring Wok Burner, 1 Rapid,  
2 Semi-Rapid, 1 Standard  
Cast Iron Pan Supports  
  
Finish: Stainless Steel (X)

 Cook like a pro with the triple ring wok burner – perfect for healthy stir fries.



**4 Gas Burners:**  
1 Triple Ring Wok Burner, 1 Rapid  
1 Semi-Rapid, 1 Standard  
Cast Iron Pan Supports  
  
Finish: Stainless Steel (X)

# Hoods

Hotpoint

## Extraction Methods

Hoods can be either Ducted (where the extracted air is directed outside the property via ducting) or Recirculation where the air recirculates back into the kitchen after passing through a filter to remove the odour.

HTC9T

90cm Chimney Hood with Curved Glass



Create a truly stylish focal point with a hood that matches your oven and hob.

Choice of width  
90cm

Extraction  
420 m<sup>3</sup>/hr

dB(A)  
61

Charcoal Filter

Push Button Controls  
2 x 20 Watt Halogen Lights  
1 Self Supporting Metal Filter  
Charcoal Filter included

Finish: Stainless Steel (X)  
Also available in: 60cm - HTC6T

# Dishwasher



## Flexipower

Our Flexipower motor drives our Intelligent Sensor System which assesses and modifies the temperature, duration, water pressure and number of rinses to ensure perfect cleaning results.



## Goodnight

This option quietyens everything down even further – perfect for running in the evening or overnight.



## Dual Space Upper Baskets

Adjust the height of the top basket in one quick movement, even when it is fully loaded, to give even more space in the lower basket.

# LFT3214/1HX

Fully Integrated Flexipower Dishwasher



A truly efficient dishwasher that uses just 10 litres of water to wash a full load of 14 place settings.



- 14 Place Settings
- 11 Programmes/6 Temperatures
- Electronic Water Softener Control
- Wash Programmes include:
  - Eco, Rapid 25, Goodnight, Shorttime, Half Load
- Dual Space Upper Baskets
- Fully Collapsible Lower Baskets
- Digital Display
- 3, 6, 9hr Delay Timer
- Waterstop & Overflow Protection
- Self Balancing Door
- Extra-Silent – just 42dB(A)

Finish: Cabinetry Door Required

# LFT04

Fully Integrated Dishwasher



For easy loading our self balancing doors won't drop down with a clatter, but stay at the right place for you to load the top basket comfortably.



- 12 Place Settings
- 4 Programmes
- 3 temperatures
- Adjustable Water Softener
- Natural Drying
- Wash Programmes include:
  - Eco, Intense, Normal
- LED Display
- Overflow Protection
- Self Balancing Door

Finish: Cabinetry Door Required



# Laundry



### Anti-Allergy

Carrying the Allergy UK Seal of Approval, our integrated washing machine features special patented technology to deliver a unique Anti-Allergy cycle designed to reduce major allergens without damaging the fibres of your clothes.



### Anti-Stain

A specially developed cycle to remove 20 of the most difficult stains including fruit, blood, chocolate, grass and felt-tip pen, without fading your colours thanks to its intelligent electronic water and temperature control.



### 5+5kg Wash and Dry Load

Our Hotpoint washer dryers have the capacity to wash and dry a 5kg load in a single uninterrupted cycle.



### Ready to Wear Cycle

This extra fast programme has been designed to wash and dry a small load of lightly soiled garments in just 45 or 60 minutes, making it perfect for refreshing an outfit the same day or night you need it...



### Woolmark Platinum Care

A special programme endorsed by Woolmark\*, the world's leading authority on all wool items. Extra gentle agitation and low spin speeds help to eliminate any friction between the fibres of wool garments, thereby ensuring a perfect wash.

\*In the UK and Eire the Woolmark is a Certification Trade Mark

## BHWMD742

Built-In Washing Machine



## BHWM149

Built-In Washing Machine



Take care of your delicates with our lingerie cycle – a specially designed gentle wash that still gives great wash performance.



Remove baby stains using the Baby Cycle designed to tackle the toughest baby food and grease marks giving better results than a standard 40°C cycle.



Spin Speed: 1400rpm  
 Number of Wash Programmes: 16  
 Wash Programmes include:  
 Woolmark Platinum Care Cycle  
 Anti-allergy Cycle – endorsed by Allergy UK  
 Delicates, Anti-stain, Eco  
 Variable Spin & Temperature  
 My Cycle Memory  
 Delay Timer  
 Digital Display

Finish: Cabinetry Door Required



Spin Speed: 1400rpm  
 Number of Wash Programmes: 16  
 Wash Programmes include:  
 Shirts, Lingerie, Baby Cycle, Delicates  
 3 Eco Cycles:  
 Cottons, Synthetics & Fast Wash  
 Variable Spin & Temperature  
 Unbalanced Load Detection System  
 Coin Trap Accessible from Front  
 LED Programme Progress Indicators

Finish: Cabinetry Door Required

## BHWDD74

Built-In Washer Dryer



## BHWD149/1

Built-In Washer Dryer



Choose the My Cycle option to select your favourite set of preferences at the touch of a button.



Spin Speed: 1400rpm  
 Number of Wash Programmes: 16  
 Wash Programmes include:  
 Woolmark Platinum Care Cycle, Delicates, Anti-stain, Ready to Wear 45, Eco  
 Number of Dry Programmes: 3  
 Drying Programmes:  
 Cottons, Synthetics & Wool  
 Variable Spin & Temperature  
 My Cycle Memory  
 Delay Timer  
 Digital Display

Finish: Cabinetry Door Required

Available: October 2012



Favourite top dirty and want to wear it tonight? Select Ready to Wear and it will be clean and dry in an hour.



Spin Speed: 1400rpm  
 Number of Wash Programmes: 16  
 Number of Dry Programmes: 3  
 Wash Programmes include:  
 Shirts, Ready to Wear 60, Baby Cycle, Delicates  
 3 Eco Cycles:  
 Cottons, Synthetics & Fast Wash  
 Drying Programmes:  
 Cottons, Synthetics & Wool  
 3 Level Set and Forget Sensor Drying  
 Variable Spin & Temperature  
 Unbalanced Load Detection System  
 LED Programme Progress Indicators

Finish: Cabinetry Door Required

### Eco Cycles

Save around 50%-70%\* of the energy used with our A rated wash performance Eco Cycles developed in partnership with Ariel.



### Cottons

For everyday cleaning needs for cotton or linen items.

### Synthetics

Designed to wash a variety of man made fibre mixtures.

### Fast Wash

A fast cycle for everyday mixed fabrics that need a freshen up or are only slightly dirty, in just 30 minutes.

\*Energy savings are up to 50% for Eco Cotton cycle, up to 68% for Eco Synthetic cycle and up to 70% for Eco Fast Wash cycle (all compared to equivalent 30°C cycle).

### Set and Forget Sensor drying



Our Set and Forget drying system uses sensors to monitor the moisture and temperature levels inside the drum of the machine, so that based on the choice of drying level you make (Iron, Hanger or Cupboard Dry), the machine senses when the load is dry. Not only convenient for you, sensor drying ensures maximum energy efficiency, by ensuring that the machine stops when the clothes reach the drying level selected.

### Iron Dry

This setting leaves a level of moisture within the clothes, helping to make ironing easier, particularly useful for shirts.

### Hanger Dry

A medium level ideal for garments which don't need ironing and can simply be placed on a hanger to finish drying.

### Cupboard Dry

The programme ends when the sensors detect very little moisture inside the drum, meaning the garments are almost completely dry and ready to put away.



Laundry

# Cooling



## Active Oxygen Technology

New Active Oxygen uses innovative technology to harness natural, pure air to help your food keep its 'first day freshness' for longer. With Active Oxygen food will look, smell and taste fresher for up to 9 days longer than in standard fridges.

Active Oxygen uses O<sub>3</sub> (trioxygen) molecules, well-known for their ability to inhibit and slow bacteria growth, to preserve food. By circulating these into the fridge, bacteria growth on food can be reduced by up to 90% which in turn reduces odours by up to 70%.\*

\*Bacteriological tests: Sereco Biotest



## Antibacterial Protection

Antibacterial Protection is built into our fridge liners giving protection for the life of the product. Working between normal cleanings it inhibits the growth of potentially harmful bacteria and reduces odours.



## Super Cool

A large number of new items in the fridge can cause the internal temperature to rise. Use Super Cool to quickly cool the temperature back to the optimum level.



## Fully Frost Free

Means exactly what it says; no more defrosting ever. Food stays fresher for longer due to the circulation of cold air in both the fridge and the freezer preventing the build up of ice.

## NCD1911 Fridge Drawers



This revolutionary award winning design gives easier access with a modern stylish look.



- 90cm Wide
- 2 Individual Drawers with Soft Close Mechanism
- Total Capacity: 190 Litres
- Wine Rack
- Adjustable Legs
- Easily Installed Under Work Surface
- 2 Salad Crispers
- 2 Fish/Meat Boxes
- Dairy Box
- Bottle Holder
- Interior Light

Finish: Cabinetry Door Required



# HM31AAE

Active Oxygen Fridge Freezer



## Active Oxygen

Enjoy fresher food for longer confident in the knowledge that Luce's Active Oxygen technology is working hard to protect your family, by reducing harmful bacteria by up to 90%, 24 hours a day.



If you eat lots of fresh food then our 70/30 split fridge freezers are ideal, where more space is given over to the fridge.



Hygiene

H+

Energy

A+

- Adjustable Thermostat
- 3 Safety Glass Shelves with Aluminium Profile
- 1 Transparent Salad Bin
- Chiller
- Meat Box
- Super Cool
- Super Freeze
- 2 Transparent Freezer Drawers
- 1 Transparent Freezer Flap
- Freezing Capacity: 6kg/24hrs
- Reversible Doors
- Fridge Gross Capacity: 200 Litres
- Freezer Gross Capacity: 75 Litres

Also available: HM31AAF Frost Free Model without Active Oxygen

# KHM325FF

Frost Free Fridge Freezer



Available: Autumn 2012



## Ice Care

With common sense and practical design in mind, we have set our ice trays neatly into the drawers of the freezer. This gives you easy access to ice cubes and more storage space for your food.



No more defrosting ever with fully frost free fridge freezers – how will you spend your time?



Hygiene

H+



Fully Frost Free

Energy

A+

- Adjustable Thermostat
- 2 Safety Glass Shelves
- 2 Transparent Salad Bins
- 1 Glass Meat Box
- 3 Transparent Freezer Drawers
- 1 Transparent Freezer Flap
- Ice Care – In Drawer Ice Trays
- Super Freeze
- Freezing Capacity: 4kg/24hrs
- Reversible Doors
- Fridge Gross Capacity: 155 Litres
- Freezer Gross Capacity: 85 Litres

Also available: HM325NI Fridge Freezer

KSF3022VL  
Larder Fridge



KSZ3022NF  
Freezer





HS2322L  
Larder Fridge





HZ2022  
Built-Under Freezer



 Keep food fresher for longer with our Pure Air circulation system that maintains a constant optimum temperature throughout the fridge.

 Find your ice cubes in an instant with our cleverly designed ice trays that sit neatly in the fronts of the freezer drawers.

 To rapidly cool your weekly shop, Super Cool reduces the fridge temperature further to prolong the freshness of your food.

 For a truly stylish kitchen, choose a matching fridge and freezer and install side by side at a height to suit you.

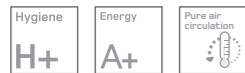

- LED Display
- 6 Safety Glass Shelves
- 3 Transparent Salad Bins
- Wine Area
- Super Cool
- Reversible Doors
- Adjustable Thermostat
- Fridge Gross Capacity: 309 Litres

Matches KSZ3022 Freezer

Available: Autumn 2012



- Adjustable Thermostat
- 2 Flap Compartments
- 5 Drawer Compartments
- Ice Care – In Drawer Ice Trays
- LED Display
- Fast Freeze Option
- Conservation Time: 14hrs
- Freezing Capacity: 10kg/24hrs
- Reversible Doors
- Freezer Gross Capacity: 202 Litres

Matches KSF3022VL Fridge

Available: Autumn 2012



- LED Display
- Super Cool
- 4 Safety Glass Shelves
- 1 Transparent Salad Bin
- Wine Area
- Reversible Doors
- Fridge Gross Capacity: 216 Litres

Matches HZ2022 Fridge



- Adjustable Thermostat
- 2 Flap Compartments
- 4 Drawer Compartments
- Fast Freeze Option
- Conservation Time: 14hrs
- Freezing Capacity: 10kg/24hrs
- Reversible Doors
- Freezer Gross Capacity: 155 Litres

Matches HS2322L Fridge

**KSF1622**  
Larder Fridge



**KSZ1422**  
Freezer



**HUL1622**  
Built-Under Larder Fridge



**HUZ1222**  
Built-Under Freezer



Enjoy protection for the lifetime of the product with Antibacterial Protection built in to the fridge liners.



- Adjustable Thermostat
- 3 Safety Glass Shelves
- 1 Transparent Salad Bin
- Reversible Doors
- Fridge Gross Capacity: 147 Litres

Matches KSZ1422 Freezer

Available: Autumn 2012



Keep food as fresh as the day you bought it with Super Freeze which rapidly lowers the temperature to freeze fresh food quickly.



- Adjustable Thermostat
- 1 Flap Compartment
- 3 Drawer Compartments
- Super Freeze
- Conservation Time: 14hrs
- Freezing Capacity: 9kg/24hrs
- Reversible Doors
- Freezer Gross Capacity: 102 Litres

Matches KSF1622 Fridge

Available: Autumn 2012



Enjoy protection for the lifetime of the product with Antibacterial Protection built in to the fridge liners.



- Adjustable Thermostat
- 2 Safety Glass Shelves
- 1 Salad Bin
- Reversible Doors
- Fridge Gross Capacity: 127 Litres







Make finding food easier with our transparent freezer fronts.





- Adjustable Thermostat
- 1 Transparent Freezer Drawer
- 2 Transparent Freezer Flaps
- Conservation Time: 21hrs
- Freezing Capacity: 8kg/24hrs
- Reversible Doors
- Freezer Gross Capacity: 86 Litres

# Oven Specifications

## Single Ovens

					
Model Number	KS0103P	KS089C	KS053C	KS033C	SHL532
Page Number	11	12	13	13	14
Colours X = Stainless Steel, W = White	X	X	X	X	X, W
Oven Type					
Electric	•	•	•	•	•
<b>COOKING FUNCTIONS</b>					
Cooking Functions	10	8	5	3	3
Circulaire Fan	•	•	•	•	•
Fast Cooking		•			
Variable Grill (Electric)		•			
Grill	•				
Fan Grilling	•	•	•	•	
Conventional		•	•		
Pizza (no preset temperature)	•	•			
Roast	•				
Bread	•				
Cake	•				
Proving		•			
Pastries		•			
Low Temperature 40°C	•				
Low Temperature 65°C	•				
Low Temperature 90°C	•				
Top Heat Only			•		
Defrost					•
<b>FEATURES</b>					
Electronic Thermostat Control	•	•			
24 Hour Electronic Timer with Time/Temp Control	•	•			
24 Hour Electronic Timer with Time Control			•	•	•
Child Lock	•				
Variable Grill	•	•	•	•	
Touch Controls	•				
Proud Controls		•	•	•	•
Variable Oven Thermostat	•				
Thermostat Light		•	•	•	•
Oven Light	Side	Side	Rear	Rear	Rear
Reversible Door					•
Glazing Level	Triple	Triple	Double	Double	Double
Air Flow Cooling Fan & Internal Venting	•	•	•	•	
Air Flow Cooling Fan					•
<b>CLEANING</b>					
Fast Clean/Pyrolytic with Grey Interior	•				
Stay Clean Oven Interior (Catalytic Liners)		•	•	•	
Easy Clean Oven Interior (Enamel)					•
Easy Clean Full Inner Door Glass		•	•	•	
<b>EQUIPMENT</b>					
Grill Grids	3	3	3	3	1
Tray	1	1	1	1	1
Tray Handle	1	1	1	1	
Telescopic Guides					2
<b>POWER</b>					
Total Power (W)	2800	2800	2400	2400	2400
Supply/Voltage (V/Hz)	230/50	230/50	230/50	230/50	230/40
<b>ENERGY</b>					
Energy Efficiency Class	A	A	A	A	A
<b>TOTAL CAPACITY (LITRES)</b>	59	62	62	62	61

## Built In/Under Double Ovens

		
Model Number	KSD99C	UHS53
Page Number	14	15
Colour		
X = Stainless Steel	X	X
Oven Type		
Electric Built-In	•	•
Electric Built-Under		
<b>TOP OVEN FUNCTIONS</b>		
Top Oven Functions	2	2
Conventional	•	•
Solarplus Twin Variable Grill	•	
Twin Variable Grill		•
Maximum Oven Temperature [°C]	220	220
<b>MAIN OVEN FUNCTIONS</b>		
Main Oven Functions	8	3
Circulaire Fan	•	•
Conventional	•	
Proving	•	
Roast Meat, Fish, Cakes, Bread and Chicken	•	
Defrost		•
Slow Cook [90°C]		•
Maximum Oven Temperature [°C]	230	230
<b>FEATURES</b>		
24 Hour Electronic Timer with Time/Temp control	Both Ovens	
24 Hour Electronic Timer with Time control		Both Ovens
Proud Controls	•	•
Thermostat Light	•	•
Oven Light	Both Ovens	Both Ovens
Glazing level	Triple	Double
Air Flow Cooling Fan/Internal Chimney Venting	•	•
<b>CLEANING</b>		
Stay Clean Oven Interior (Catalytic Liners)	•	
Easy Clean Enamel Oven Finish		•
Easy Clean Inner Door Glass	•	
<b>EQUIPMENT</b>		
Top Oven Shelves	1	1
Main Oven Shelves	2	2
Grill Pan Kit (with handle)	•	•
<b>POWER</b>		
Total Power (W)	4900	4800
Supply/Voltage (V/Hz)	230/50	230/50
<b>ENERGY</b>		
Top Oven Energy Efficiency Class	A	B
Main Oven Energy Efficiency Class	A	B
<b>TOTAL CAPACITY (LITRES)</b>		
Top Oven	39	37
Main Oven	74	59

## Microwave Ovens

	
Model Number	MWH121
Page Number	15
Colour X/I = Stainless Steel	X
Fingerprint Resistant	
<b>DIMENSIONS</b>	
Capacity (Litres)	20
Height x Width x Depth (cm)	39.0 x 59.5 x 32.0
<b>POWER</b>	
Microwave Total Power (W)	1200
Microwave Power Levels (W)	300-315-450-550-750-800
<b>COOKING COMBINATIONS</b>	
Functions	1
Microwave	•
Automatic Programmes	4
Control	Electronic
Side Opening Door	•
Digital Clock/Electronic Timer	•
<b>FEATURES</b>	
Turntable Diameter (cm)	25.5
Number of Power Levels	6
Number of Auto Programmes	4
Interior	Enamelled
Oven Light	1 x 15W
Timer (mins)	59
"Cooking End" Alarm	•
Grid Shelves	1

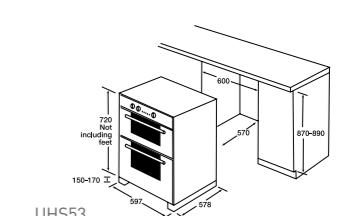
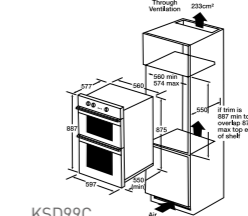
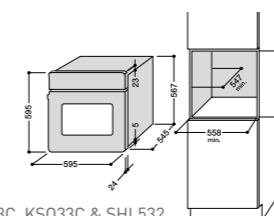
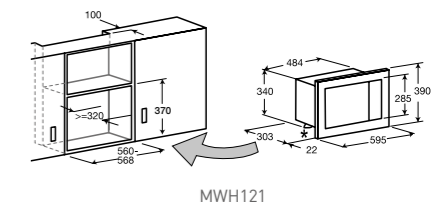

KS0103P, KS089C, KS053C, KS033C & SHL532

KSD99C

UHS53

# Hob Specifications

## Hobs

	CI0744DO	CI0644DD	KSC640	GC760F	GC751T	KSG641
Model Number	CI0744DO	CI0644DD	KSC640	GC760F	GC751T	KSG641
Page Number	17	17	18	18	19	19
Colour X = Stainless Steel			X	X	X	X
Finish B = Bevelled, Z = Steel Front Profile	B	Z				
<b>DIMENSIONS (CM)</b>						
Width	70	60	60	75	75	60
<b>TYPE</b>						
Induction	•	•				
Gas				•	•	•
Ceramic			•			
<b>FEATURES</b>						
Number of Heat Zones/Burners	4	4	4	6	5	4
Touch Control	•	•	•			
Power Levels	9	9	9			
Power Level Indicators	•	•	•			
Residual Heat Indicators			•			
Time Control Elements	4	4				
Audio Signal at End of Time	•	•				
Child Lock	•	•	•			
Pan/Small Tool Detection	•	•				
Control Dials				•	•	•
Front Controls				•	•	•
Automatic Ignition				•	•	•
Flame Supervision Device				•	•	•
Number of Pan Supports				3	3	3
Cast Iron Pan Supports					•	•
Enamelled Pan Supports				•		
<b>POWER</b>						
Total Power Output (kW)	7.2	7.2	6.6			
Induction Ring	2 x 1.4kW*	2 x 1.4kW*				
Double Induction Ring	1 x 2.2kW**	2 x 2.2kW**				
Oval Induction Ring	1 x 2.2kW**					
Triple Ring Wok Burner					1 x 3.6kW	1 x 3.25kW
Double Face Elliptical Burner				2 x 1.5kW		
Rapid Burner				1 x 2.6kW	1 x 2.6kW	1 x 2.6kW
Semi-Rapid Burner				1 x 1.65kW	2 x 1.65kW	1 x 1.65kW
Standard Burner				2 x 1.0kW	1 x 1.0kW	1 x 1.0kW
Hilight Zone			1 x 1.2kW, 1 x 1.4kW, 1 x 1.8kW, 1 x 2.3kW			
Possible to Install in 60cm Wide Cut-Out	•			•	•	
LPG Conversion Kit Included				•	•	•

\*Booster up to 2.0kW  
\*\*Booster up to 3.0kW

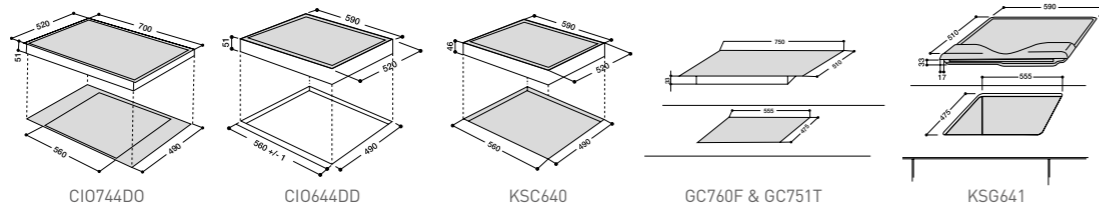

# Hood Specifications

## Hoods

	HTC9T	HTC6T
Model Number	HTC9T	HTC6T
Page Number	21	21
Hood Type	Chimney	Chimney
Colour X = Stainless Steel	X	X
<b>FEATURES</b>		
On/Off Switch	•	•
Push Button Controls	•	•
Light Switch	•	•
Halogen Lights (20W)	2	2
Metal Filters	•	•
Charcoal Filter(s) Supplied	•	•
Charcoal Filter Part No.	57772	57772
Ducting or Recirculating Option	•	•
Ducting Size (mm)	150	150
Output (m3/hr)	420	420
IEC Extraction Rate (m³/hr)	360	360
Noise Level at Max Power dB(A)	61	61
<b>DIMENSIONS (CM)</b>		
Width	90	60

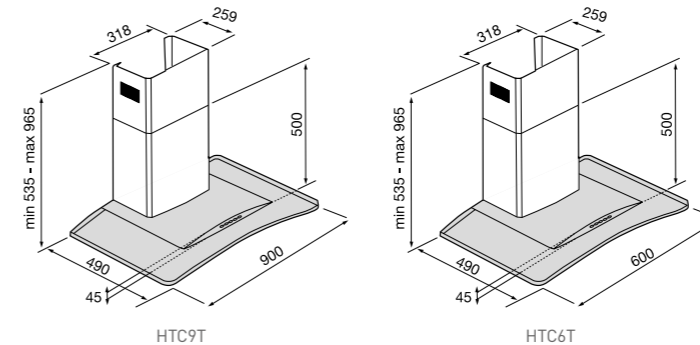

# Dishwashing Specifications

## Dishwashers



Model Number	LFT3214/1HX	LFT04
Page Number	23	24
Fully Integrated	•	•
<b>ENERGY</b>		
Energy Efficiency Class	A+	A
Wash Performance Class	A	A
Drying Performance Class	A	A
Annual Energy Consumption (kWh/Annum) – Standard Cleaning Cycle (280 Eco Wash & Cold Fill Cycles)	285	305
Water Consumption (Litres) – Standard Cleaning Cycle (Eco Wash & Cold Fill Cycles)	10	12
Annual Water Consumption (Litres/Annum) – Standard Cleaning Cycle (280 Eco Wash & Cold Fill Cycles)	2800	4480
<b>FEATURES</b>		
Electronic Control	•	•
Hidden Heating Element	•	•
Noise Emission (dB)	42	51
<b>LIGHTS</b>		
Salt	•	•
Rinse Aid	•	•
<b>PERFORMANCE</b>		
Programmes	11	4
Temperatures	6	3
Goodnight	•	•
Place Settings	14	12
Rapid (mins)	25	•
Short Time	•	•
Delay Timer (hrs)	3, 6, 9	•
Duo Wash	Auto	•
Eco Wash	•	•
Standard Baskets	•	•
Standard Cutlery Basket	•	•
Baskets Fold Flat	•	•
Divisible Cutlery Basket	2 Part	•
Dual Space Upper Basket	•	•
Super Sliding Baskets	•	•
Waterstop Protection	•	•
Overflow Protection System	•	•
Adjustable Water Softner	•	•
Self Balancing Door	•	•
<b>STRUCTURE</b>		
Easy Installation Package (Fast Fix)	•	•
Cold Fill Only	•	•
Rear Foot Adjustable from Front	•	•
Supply/Voltage (V/Hz)	230/50	230/50

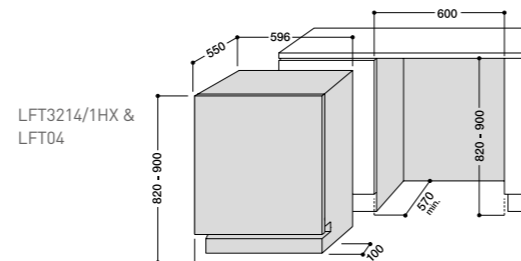

LFT3214/1HX & LFT04

# Laundry Specifications

## Laundry



Model Number	BHWMD742	BHWM149	BHWDD74	BHWD149/1
Page Number	27	27	28	28
Type	•	•	•	•
Washing Machine	•	•	•	•
Washer Dryer	•	•	•	•
Spin Speed	1400	1400	1400	1400
Wash Capacity (kg)	7	7	7	7
Drying Capacity (kg)	•	•	5	5
<b>ENERGY</b>				
Energy Efficiency Class	A++	A+	B	B
Wash Performance Class	A	A	A	A
Spin Performance Class	B	B	B	B
Annual Energy Consumption kWhr/annum (based on 220 Standard Cycles)	187	212	1061*	1061*
Annual Water Consumption litres (based on 220 Standard Cycles)	9039	9039	20400*	20400*
<b>INTERFACE</b>				
LCD Display	•	•	•	•
<b>SPECIAL FEATURES</b>				
Child Lock	•	•	•	•
Delay Timer	•	•	•	•
Woolmark Platinum Care	•	•	•	•
Super Silent	•	•	•	•
Delicate Programme (Silk & Curtains)	•	•	•	•
My Cycle Memory	•	•	•	•
Time Saver	•	•	•	•
Automatic Drying Level	•	•	•	3
<b>PROGRAMMES</b>				
Number of Cycles	16	16	16	16
Anti Allergy	•	•	•	•
Auto Clean	•	•	•	•
Number of Drying Cycles	•	•	3	•
Ready to Wear	•	•	45mins	60mins
Eco Cycles	•	3	•	3
Number of Drying Cycles	•	•	•	3
<b>OPTIONS</b>				
Eco Wash	•	•	•	•
Extra Rinse	•	•	•	•
Easy Iron	•	•	•	•
Anti Stain	•	•	•	•
Super Wash	•	•	•	•
Mini Load	•	•	•	•
Pause	•	•	•	•
<b>PERFORMANCE</b>				
Balance Check	•	•	•	•
Noise Emission (dB)- 60°C Cotton Cycle Wash Phase (Full Load)	56	56	56	56
Noise Emission (dB)- 60°C Cotton Cycle Spin Phase (Full Load)	79	79	79	79
Time for Wash [60°C Cotton Cycle Full Load]	195	192	153	153
Adjustable Spin Speed (rpm)	600-1400	600-1400	600-1400	600-1400
<b>SAFETY</b>				
Overflow System	•	•	•	•
Coin Trap Accessible from Front	•	•	•	•
<b>SUPPLY</b>				
Cold fill Only	•	•	•	•
Supply/Voltage (V/Hz)	230/50	230/50	230/50	230/50

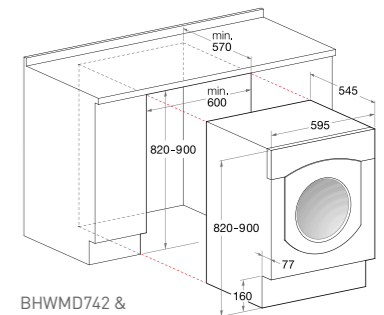

BHWMD742 & BHWDD74

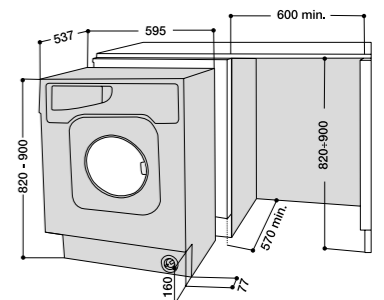

BHWM149 & BHWD149/1

# Refrigeration Specifications

## Fridge Drawers



Model Number	NCD1911
Page Number	31
Fridge Drawers	•
<b>ENERGY</b>	
Energy Efficiency Class	A+
Annual Energy Consumption (kWh/Annum)	120.45
Noise Emission (dB)	40
<b>FEATURES</b>	
Width (mm)	900
Gross Capacity (Litres)	190
Net Capacity (Litres)	150
No. of Drawers	2
Salad Crispers	2
Meat/Fish Boxes	2
Soft Close Mechanism	•
Dairy Box	•
Bottle Holder	•
Wine Rack	•
Adjustable Legs	•
Antibacterial Protection	•
Interior Light	•
<b>PRODUCT DIMENSIONS</b>	
Width (mm)	898
Height (mm)	835-865
Depth (mm)	548

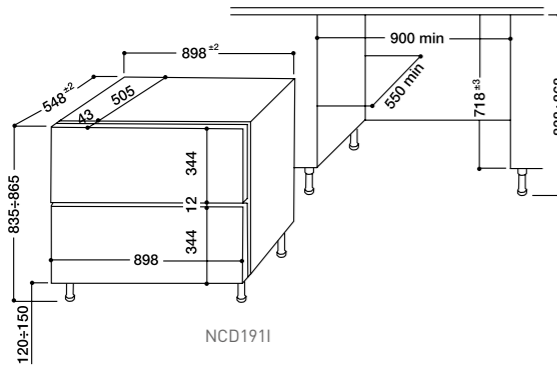

NCD1911

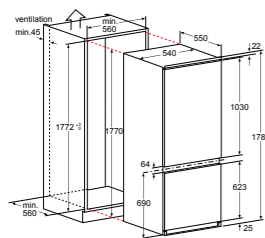

HM31AAE & HM31AAF

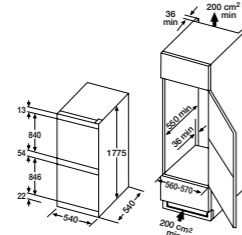

KHM325FF & HM325NI

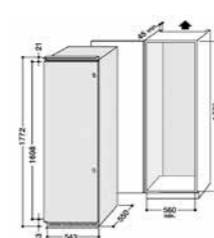

KSF022VL & KSZ3022NF

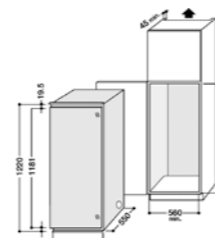

HS2322L & HZ2022

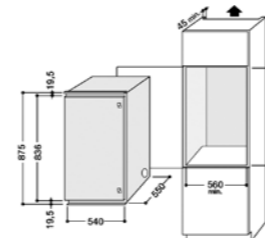

KSF1622 & KSZ1422

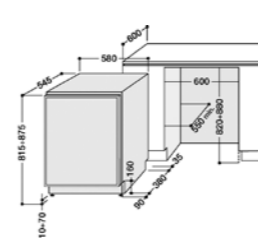

HUL1622 & HUZ1222

## Fridges & Freezers



Model Number	HM31AAE	HM31AAF	KHM325FF	HM325NI	KSF3022VL	KSZ3022NF	HS2322L	HZ2022	KSF1622	KSZ1422	HUL1622	HUZ1222
Page Number	32	32	33	33	34	34	35	35	36	36	37	37
Larder	•	•	•	•	•	•	•	•	•	•	•	•
Fridge Freezer	•	•	•	•	•	•	•	•	•	•	•	•
Freezer	•	•	•	•	•	•	•	•	•	•	•	•
<b>ENERGY</b>												
Energy Efficiency Class	A+	A+	A+	A+	A+	A+	A+	A+	A+	A+	A+	A+
Energy Consumption (kWh/24hrs)	0.79	0.78	0.98	0.77	0.4	0.84	0.38	0.64	0.35	0.55	0.34	0.5
Annual Energy Consumption (kWh/Annum)	290	284	356	282	151	305	138	235	128	199	125	184
Noise Emission (dB)	36	39	41	43	40	42	43	42	36	39	39	44
Conservation After Power Failure (hrs)	18	11	10	15		8		14		14		17
<b>CAPACITY</b>												
Total Gross Capacity (Litres)	275	257	240	260	309	202	216	155	147	102	127	86
Fridge Gross Capacity (Litres)	200	200	155	155	309		216		147		127	
Freezer Gross Capacity (Litres)	75	57	85	105		202		155		102		86
Total Net Capacity (Litres)	255	252	224	235	303	190	213	132	144	84	123	63
Fridge Net Capacity (Litres)	198	198	150	150	303		213		144		123	
Freezer Net Capacity (Litres)	57	54	74	85		190		132		84		63
<b>FEATURES</b>												
Display Type	Digital	Digital			LED	LED	LED					
Reversible Doors	•	•	•	•	•	•	•	•	•	•	•	•
<b>FRIDGE</b>												
Pure Air System					•							
Super Cool	•	•			•							
Antibacterial Protection	•	•	•	•	•				•		•	
Wine Rack			S/Steel	•	•							
Glass Shelves	•	•	•	•	•				•			
Internal Light	•	•	•	•	•				•		•	
Salad Crispers	1	1	2	2	3		1		1			
Egg Rack	•	•	•	•	•		•		•			
Meat Box	Glass	Glass	Glass	Normal							1	
Chiller	•											
Butter Box			•	•								•
Automatic Defrost Function	•	•	•	•	•		•		•		•	•
Flexible Door Shelving	•	•	•	•	•		•		•		•	•
<b>FREEZER</b>												
Star Rating	***	****	***	****		****		***		****		****
Defrost Function	Manual	Auto	Auto	Manual		Manual		Manual		Manual		Manual
Fast Freezing	•		•			•		•		•		•
Ice Cube Trays												1
Freezing Capacity (kg/24hrs)	6	2	4	2		10		10		2		8
Number Flap Compartments	1	1	1			2		2		1		2
Number Drawer Compartments	2	2	3	4		5		4		3		1
Ice Care in Drawer/Basket	1	1	2	2		4		2				

In accordance with its policy of progressive product design and environmental protection, Indesit Company reserves the right to alter specifications and use quality recycled components. To confirm that the specification and/or functions required are still current on the selected model, please call our product information team on 08000 92 19 22 (If calling within the Republic of Ireland please call 0818 36 50 08) prior to purchase. Every attempt has been made to ensure an accurate colour representation.

## We're here if you ever need us... 364 days a year!

### Call us 364 days a year

Hotpoint service is second to none. We are open when you need us and our operators are on hand to answer your call every day, except Christmas day, including weekends and bank holidays on 08448 22 42 24 (if calling within the Republic of Ireland please call 0818 31 34 13). Alternatively book online at [www.hotpointservice.co.uk](http://www.hotpointservice.co.uk)

### Local engineers nationwide

We are the largest white goods service team in the United Kingdom & Republic of Ireland with fully trained Hotpoint specialists to ensure you receive fast, reliable and local service.

### Appointments to suit you

We do everything possible to fit in with your busy lifestyle. You can choose between morning or afternoon appointments, with the option of the engineer's first or last visit of the day. Saturday appointments are also available in some areas. We will send you a text message with a 2 hour time slot on the morning of your appointment.

### Professional workmanship - by the experts

Our engineers are professionally trained at the Hotpoint School of Excellence and receive continuous training to ensure they are up-to-date with the latest products. We only fit genuine Hotpoint replacement parts and guarantee our work for a full 90 days.

### Guaranteed parts for 5 years

Your Hotpoint appliance is covered for a full 12 months by our own parts and labour warranty. In addition, when you register your appliance we also provide free parts for the first 5 years when fitted by our highly qualified engineers. Please call 08448 24 24 24 for more information (if calling within the Republic of Ireland please call 012 30 02 33)

### Satisfaction guaranteed

Within the first 90 days of ownership we have a dedicated team who provide fast track product advice and assistance to deal with your enquiries quickly and efficiently. In the unlikely event that a technical problem occurs that cannot be resolved in this period we will replace your appliance.

### Your peace of mind with total protection

We offer a selection of repair protection plans that will enable you to fully cover any number of Hotpoint appliances – after your warranty expires – including new for old product replacement in the event they cannot be repaired. Please call 08448 22 62 26 for more information (if calling within the Republic of Ireland please call 012 30 02 33).



We're here to help you, call us on

08448 22 42 24

or visit our website [www.hotpointservice.co.uk](http://www.hotpointservice.co.uk)

(if calling from within the Republic of Ireland please call 0818 31 34 13)







Our ideas. Your home.

08000 92 19 22 from the UK  
0818 36 50 08 from Eire

[www.hotpoint.co.uk](http://www.hotpoint.co.uk)  
[www.hotpoint.ie](http://www.hotpoint.ie) (Republic of Ireland)

Indesit Company, Morley Way,  
Peterborough, PE2 9JB, UK

Brochure No. 18M/07.12/A/P962

Published July 2012.  
Supersedes brochure no. P905



## Free Manuals Download Website

<http://myh66.com>

<http://usermanuals.us>

<http://www.somanuals.com>

<http://www.4manuals.cc>

<http://www.manual-lib.com>

<http://www.404manual.com>

<http://www.luxmanual.com>

<http://aubethermostatmanual.com>

Golf course search by state

<http://golfingnear.com>

Email search by domain

<http://emailbydomain.com>

Auto manuals search

<http://auto.somanuals.com>

TV manuals search

<http://tv.somanuals.com>