

## HOTPOINT SERVICE OFFICES

If you have any trouble with your appliance, please call whichever of these numbers you think is applicable. It does not matter if you guess wrong; we'll make sure that the nearest Hotpoint Service Office tackles the problem.

### NORTH EAST

**N. Humbs E. Yorks:**  
 Queen House Building, Whitehartgate, Hull  
 Tel: Hull 224777

**S. Yorks:**  
 Memory Richards, Mexborough, South Yorkshire  
 Tel: Mexborough 562831

**N. & W. Yorks:**  
 Sandbeck Lane, Wetherby, West Yorkshire  
 Tel: Wetherby 614440/1261

**S. Durham, Cleveland:**  
 59 Alport Road, Middlesbrough  
 Tel: Middlesbrough 246456

**N. Durham, Tyne & Wear, N. Humberside:**  
 24 Northumberland Road, Newcastle upon Tyne  
 Tel: Newcastle 321008

### NORTH WEST

**Cumbria, Lancashire:**  
 10 Ship Road, Kendal, Cumbria  
 Tel: Kendal 24483

**Lancashire:**  
 2423 Canton Street, Preston, Lancashire  
 Tel: Preston 24311

**Greater Manchester:**  
 44-46 Station Road, Heaton Mersey, Stockport  
 Tel: 061-442 9677

**Merseyside:**  
 49 Cowley Hill Lane, St. Helens, Merseyside  
 Tel: St. Helens 55152

**Cheshire, Wirral:**  
 1 Church Parade, Fisherside Park, South Wirral  
 Tel: 051-356 2141

### S & W MIDLANDS

**Herefordshire:**  
 3/5 Birstington Hill, Birstington, Bristol  
 Tel: Bristol 714471

**Berks, Bucks, Oxon:**  
 224 Broadway, Oxford, Oxon  
 Tel: Oxford 817711

**Salis, Shropshire:**  
 West Avenue, Nelson Estate, Take, Stoke on Trent  
 Tel: Kidsgrove 74511

**Worce, Birmingham, W. Midlands:**  
 Westgate, Aldridge, W. Midlands  
 Tel: Aldridge 55641/55961

### E. MIDLANDS

**Leics:**  
 De Wortton House, Belgrave Gate, Leicester  
 Tel: Leicester 29936

**N. Lincs, S. Humbers:**  
 Fifth Road, Lincoln  
 Tel: Lincoln 33611

**S. Lincs:**  
 Cella Road, Fletton, Peterborough  
 Tel: Peterborough 64741

**Northants, Warwick:**  
 398 Cambridge Street, Wellingborough, Northants  
 Tel: Wellingborough 223609

**Notts, Derby:**  
 Ashling Street, Nottingham  
 Tel: Nottingham 862431

### EASTERN

**Beds, N. Herts:**  
 5 Crawley Road, Luton, Beds  
 Tel: Luton 452211

**Norfolk, Suffolk:**  
 97 Upper St. Giles Street, Norwich  
 Tel: Norwich 20581

**Cants Hunts:**  
 Cella Road, Fletton, Peterborough, Cants  
 Tel: Peterborough 64741

**Essex:**  
 Industrial Buildings, Beehive Lane, Chelmsford, Essex  
 Tel: Chelmsford 269331

### LONDON & SOUTH EAST

**Middlesex, S. Herts:**  
 68 East Lane, Wembley, Middlesex  
 Tel: 01-908 1933

**London:**  
 68 East Lane, Wembley, Middlesex  
 Tel: 01-904 1250

**Surrey:**  
 2 St. Nicholas Road, Sutton, Surrey  
 Tel: 01-643 0921

**Sussex:**  
 1 Kingswood, North Street, Hailsham, Sussex  
 Tel: Hailsham 842733

**Kent:**  
 Latfield Trading Estate, New Hythe Lane, Latfield, Kent  
 Tel: Maidstone 76571

### SOUTH WEST

**Glouce, Avon, Wilts, Somerset:**  
 3/5 Birstington Hill, Birstington, Bristol  
 Tel: Bristol 714471

**Devon:**  
 63 Witley Plain, Plymouth  
 Tel: Plymouth 262631

**Hampshire, Dorset:**  
 South Hampshire Industrial Park, Salisbury Road, Totton, Hants  
 Tel: Southampton 861981

### SCOTLAND

**Grampian, Highlands:**  
 Holbeck House, 68 Garden Place, Aberdeen  
 Tel: Aberdeen 6422263

**Tayside, Fife, Perth:**  
 Bannerman House, South Tay Street, Dundee  
 Tel: Dundee 26383

**Central, Lothians, Borders:**  
 West Bowling Green Street, Leith, Edinburgh  
 Tel: 031-554 1431

**Strathclyde, Dumfries, Galloway:**  
 West Lodge Road, Blythswood Estate, Renfrew  
 Tel: 041-886 6241

### WALES

**North Wales:**  
 Conwy Road, Llandudon Junction  
 Tel: Deeganwy 82626

**Mid & S. Wales:**  
 18 Western Avenue, Bridgend Industrial Estate, Bridgend, Mid Glamorgan  
 Tel: Bridgend 64121

### IRELAND

**Northern Ireland:**  
 256 Ormeau Road, Belfast 7  
 Tel: Belfast 647111

**East:**  
 35/36 Arvan Quay, Dublin 7  
 Tel: Dublin 729522

Sometimes a number is changed when an edition of this booklet is still current. So if you get no reply from one of these, either try another of the numbers shown here, or see under Hotpoint in your telephone book.

# Hotpoint

Hotpoint Ltd., Peterborough, England, PE2 9JB

91477 0778

Full Instructions for  
 Installing and Operating  
 your Hotpoint Double Oven  
 Model 61250

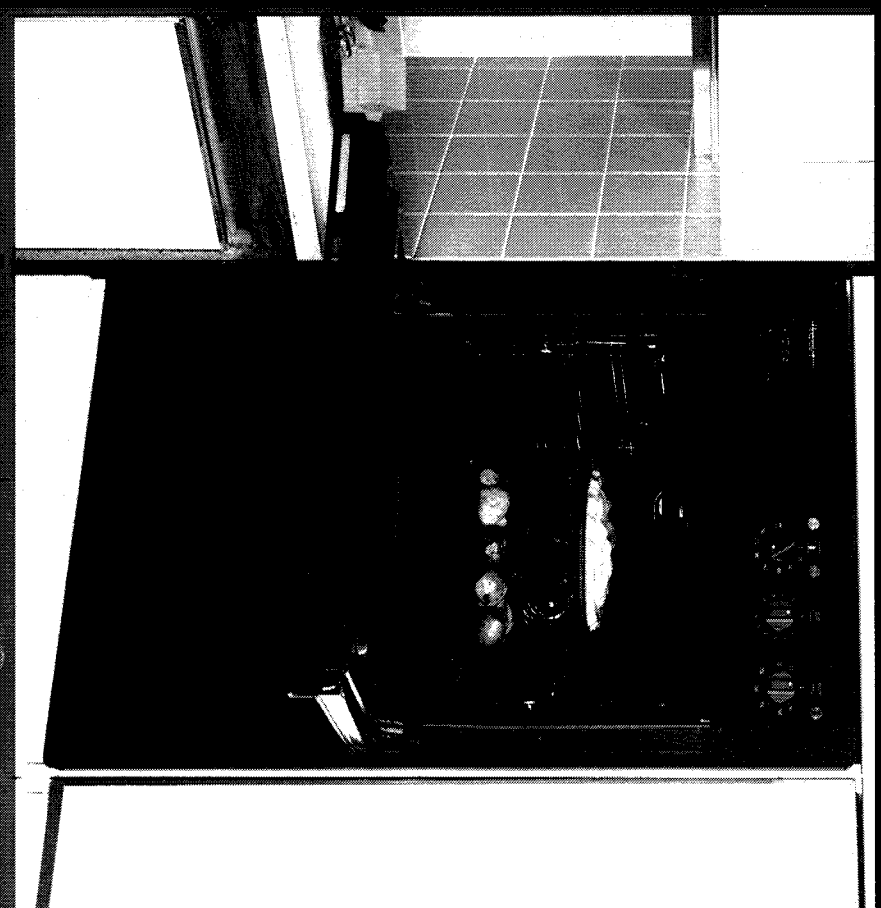

# Hotpoint

# Your new Double Oven

Using your new Double Oven is easy. Nevertheless, to get the very best results it is important to get to know your new appliance by reading right through this handbook **before** using your oven for the first time. For installation into your housing unit please see page 20.

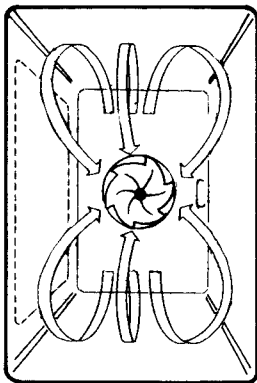

The main oven is equipped with a fan and operates by constantly circulating heated air around the oven. This gives improved efficiency and, in general, enables the use of lower cooking temperatures. It also means that there is less need to be particular about shelf positions and that you can bake at more than one level simultaneously.

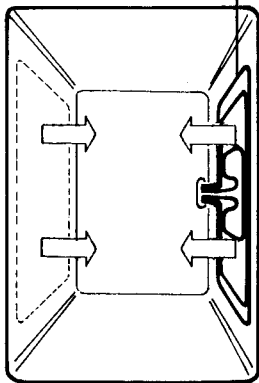

The lower oven is equipped with a conventional top and bottom heating system. This system is suitable for roasting and baking on one shelf only.

**Variable Grilling**  – the lower oven can be used for full width and economy grilling.

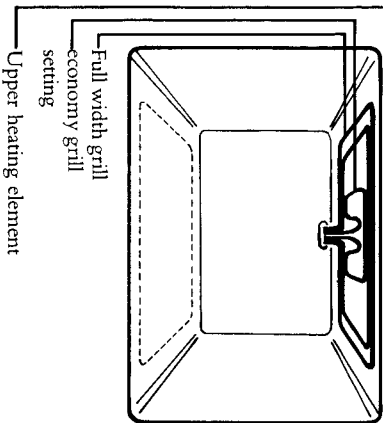

Further information about the cooking systems is described in the separate recipe book and we would suggest you read right through the Introductory Section of that book **before** using the oven.

Adequate ventilation must be provided (see Figure 2). Particular attention must be paid to ensure that the air inlet and outlet areas are kept clear. Sufficient space must be left between the top of the housing unit and the ceiling to allow a free flow of air.

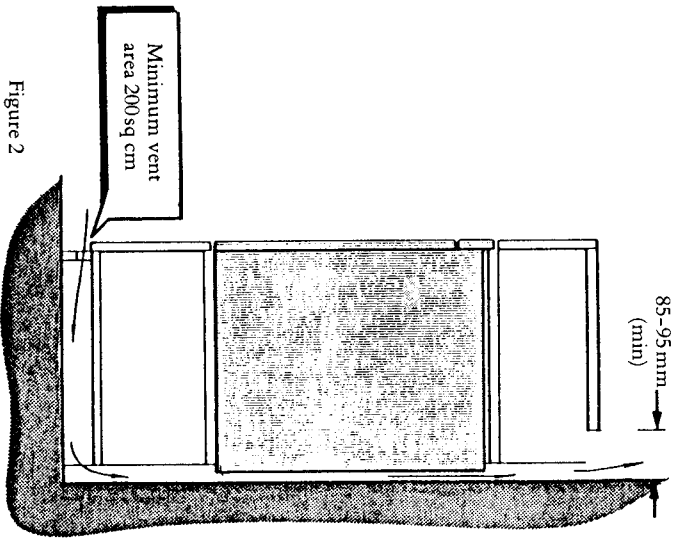

Figure 2

### Electrical Connections

Remove the terminal cover at the rear base of the cooker. Pass the cable through the cable clamp and connect to the appropriate terminals provided. Allow sufficient cable so that the oven can be set down on the floor whilst still connected up. Tighten the screws on the cable clamp and replace the terminal cover. Make mains connections.

### Installing the Oven into the Housing Unit

Do not lift or carry the oven by the door handles. It is advisable to remove the oven doors before attempting to lift the oven. (See page 16.)

Lift and slide the oven into the housing unit as far as it will go ensuring the connecting cable is not trapped beneath or behind. Centrise the oven within the housing unit and secure through the side trims using the four screws supplied. Replace the oven doors.

# Contents

	Page
Get to know the main parts of your Double Oven .....	4
Before using your oven for the first time .....	5
The Controls .....	6
Main Oven Control	
Lower Oven Controls	
The Automatic Oven Timer	
Minute Minder	
Cooking in the Main Oven .....	10
Baking, Roasting and Defrosting	
Cooking in the Lower Oven .....	13
Baking and Roasting	
Variable Grilling	
Warming Dishes	
Temperature Conversion Chart .....	15
Caring for Your Double Oven .....	16
Cleaning the Outside	
Cleaning the Main and Lower Oven Doors	
Interior Oven Cleaning and Maintenance	
How to replace the Main Oven Light Bulb .....	18
If your Oven won't work .....	19
Your Guarantee .....	19
Installation Instructions for Your Built-In Double Oven .....	20
Dimensional Requirements	
Electrical Connections	
Installing the Oven into the Housing Unit	
Hotpoint Service Offices .....	24

# Get to know the main parts of your Double Oven

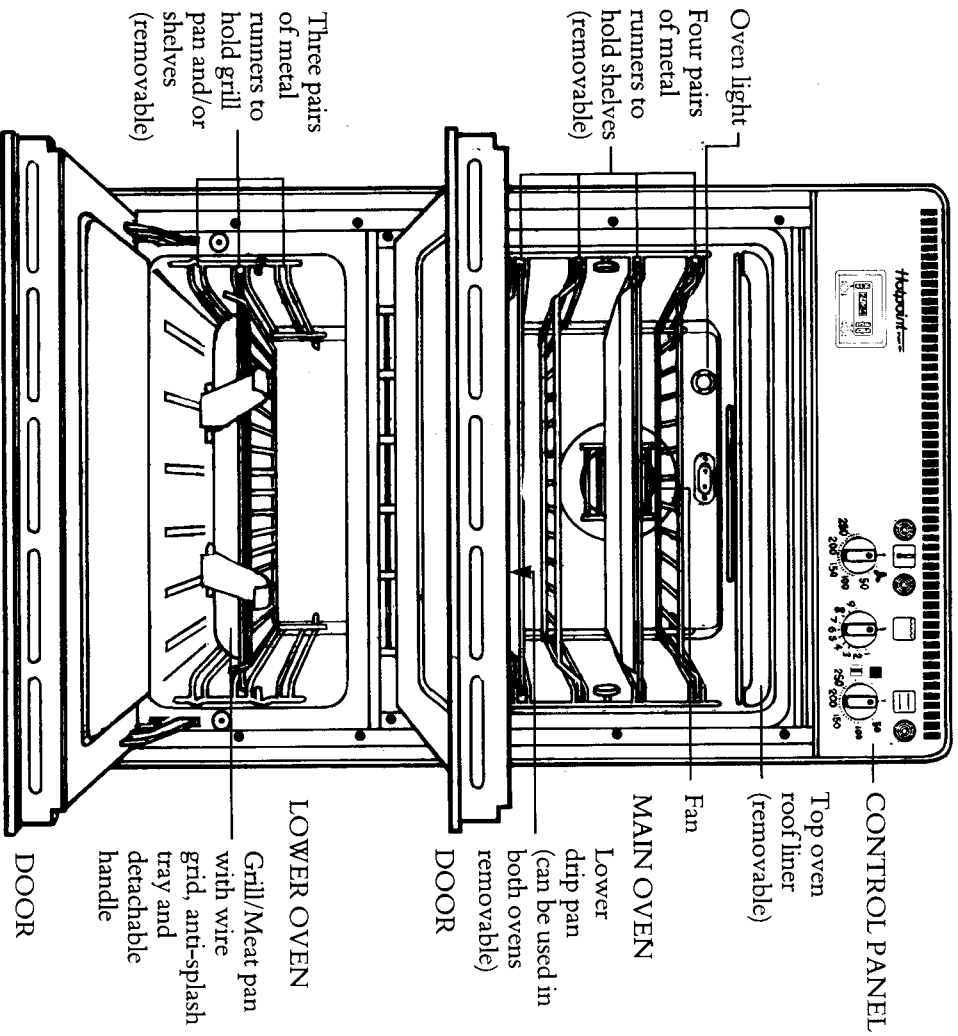

## Oven furniture

Should include:

- 2 wire shelves, 1 grill shelf, 1 grill/meat pan with wire grid and detachable handles, 2 metal drip trays, 1 lower drip pan, 1 removable top oven roof liner.

## Dimensional requirements

Dimensions for the housing unit recess and the oven are given in Figure 1. The housing unit must be firmly attached to the wall before the oven is installed.

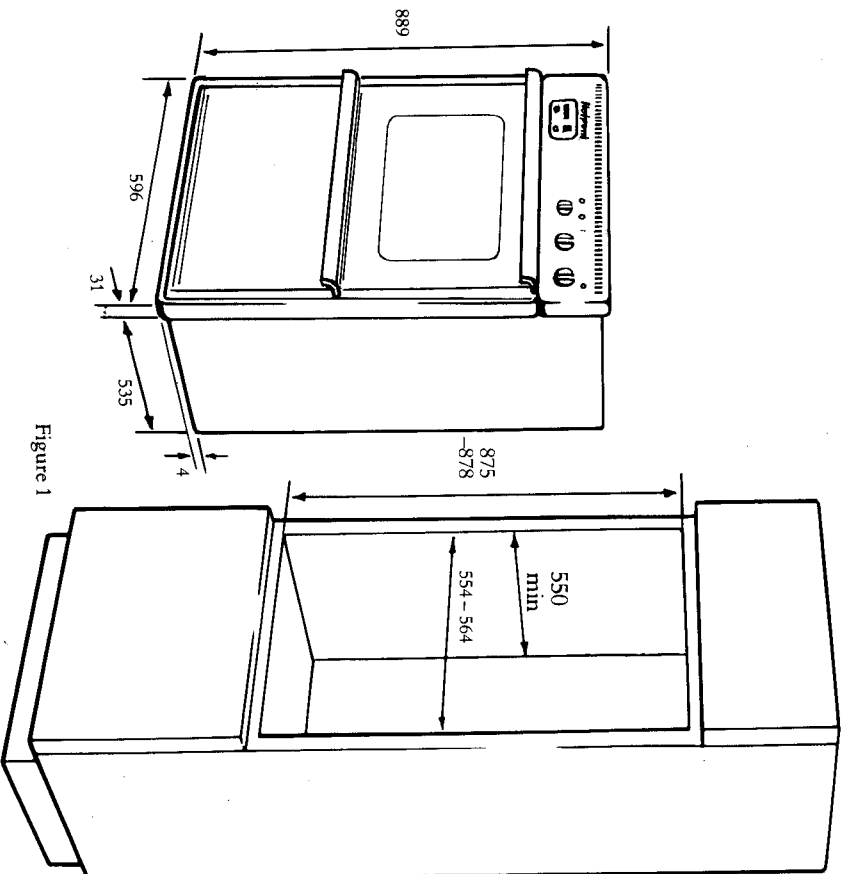

# Installation instructions for your Built-In Double Oven

# Before using your Oven for the first time

## General Requirements

Any electrical wiring must be carried out in compliance with the appropriate IEE and local electricity board regulations by a qualified electrician, eg. your local electricity board or a contractor who is on the roll of the National Inspection Council for Electrical Installation Contracting (NICEIC).

**Incorrect installation could affect the safety of the appliance.**

The installer must check that the voltage shown on the rating plate is a.c. (alternating current) and corresponds with your house electricity supply.

**WARNING – ALL APPLIANCES MUST BE EARTHED.**

The oven must be supplied via a suitable double pole isolating switch placed in a readily accessible position adjacent to the unit.  
The loading for this appliance is 5.35kW.

Before connecting or installing the Double Oven the electricity supply must be switched OFF.

If the oven is to be wired into a connector unit this may be positioned behind the oven provided that the following requirements are met.

1. The connector unit must not project more than 25 mm from the wall.
2. The top of the connector must not be more than 350 mm above the base of the oven recess.

After unpacking the oven, stand it on the packing base to avoid damage.

The housing unit into which the oven is to be placed should be solid wood or have a melamine or laminate finish.

## Make sure the electricity supply is switched ON.

For normal operation (without automatic timing) the symbol  (Manual) must be set on the Cooking Duration Scale  (see page 8) if the scale is at a different setting turn the Timer Control directly underneath clockwise until the setting  is reached.

To remove the 'new smell', heat up the empty ovens for 30 minutes, keeping the doors closed. To heat up the Main Oven turn the Main Oven Control Knob  clockwise to 250°C. When you do this the orange Mains ON/OFF light and the red Main Oven Thermostat Light will come on, as will the interior oven light and the oven fan.

To heat up the lower, smaller oven turn the lower oven control knob  clockwise to 250°C. The red lower oven thermostat light will come on, as will the orange Mains ON/OFF light.

# The Controls

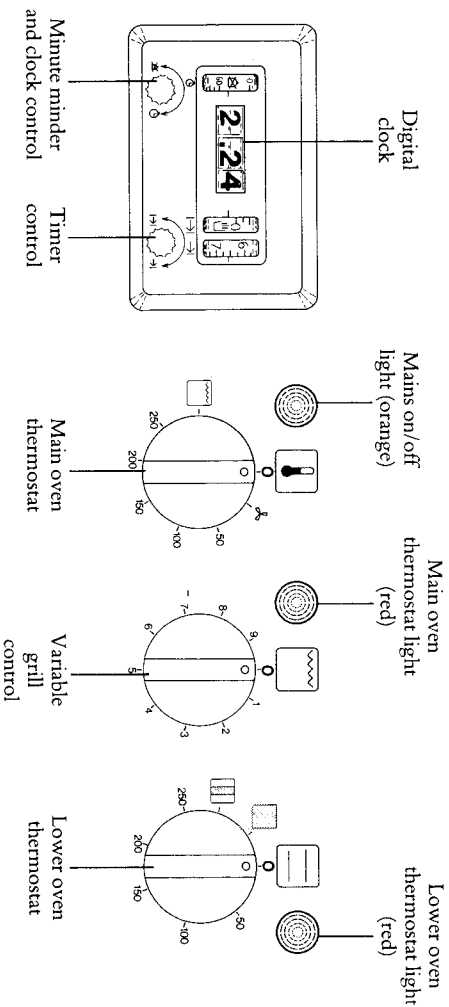



## Mains ON/OFF Light (Orange)

This light will come on and stay on as soon as the Main Oven Thermostat or the Lower Oven Thermostat is turned on.

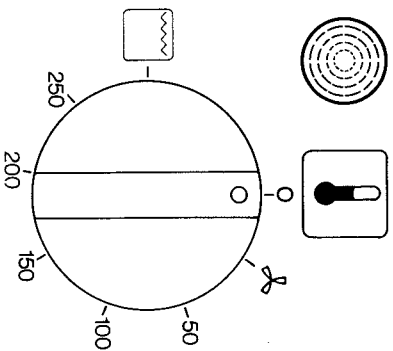
## MAIN OVEN CONTROL





To use the main oven, you must turn the Main Oven Thermostat control  clockwise to the required temperature. The red Thermostat Light will immediately come on and remain on until the oven reaches the required temperature. The light will then cycle on and off during cooking as the oven maintains this temperature. If the Thermostat Light does not come on when the Main Oven is turned on, check that the Manual/Automatic Switch is turned to  (manual). Always remember to keep the oven door closed. After use always set the oven control back to 'O' (off).

# If your Oven won't work

## ... don't panic.

Just quickly check these points before calling a Hotpoint engineer.

1. Check that the mains supply has been switched on.
2. Check that the Time Control has been set to  (Manual) operation and not left on automatic (see page 8).
3. If using the Lower Oven for grilling, have you turned the Lower Oven Thermostat to  or .
4. A fan can be heard as soon as the Top Oven Thermostat is switched on. This is quite normal when the oven is in operation.

If after following the instructions your oven still won't work properly call your nearest Hotpoint Service Office. The telephone number is shown on the back page of this handbook.

When you contact us we will want to know:

- A. Your name, address, post code and telephone number, plus details of the fault.
- B. The model number (61250) and when the appliance was purchased. Please put the date here:

.....  
 Meanwhile, switch off the oven at the mains supply and leave it alone until the Engineer calls.

## FIVE YEAR GUARANTEE

From the moment your Oven is delivered, Hotpoint guarantees it for FIVE YEARS. During the five years all parts are completely free of charge provided they are fitted by Hotpoint's own Service Engineer. Labour costs are chargeable after the first year.

This guarantee does not cover accidents, negligence or power cuts. The appliance must be used in the United Kingdom and must not be tampered with or taken apart by anyone who is not an authorised Hotpoint representative. Hotpoint's guarantee in no way limits your legal rights.

Service is provided by Hotpoint's own Service organisation. Should you have any problems, simply telephone your nearest Service Office, the address for which is shown on the back page of this handbook. Please attach your purchase receipt to this handbook and retain in a safe place.

**In accordance with its policy of progressive product design, Hotpoint reserves the right to alter specifications.**

## How to replace the Main Oven Light Bulb

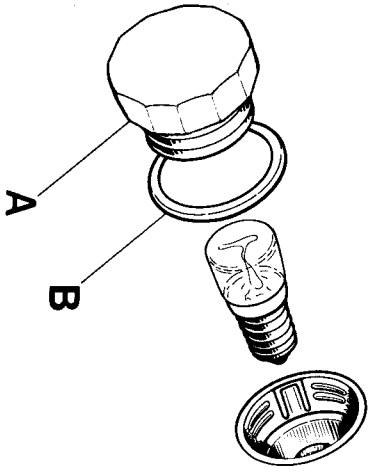

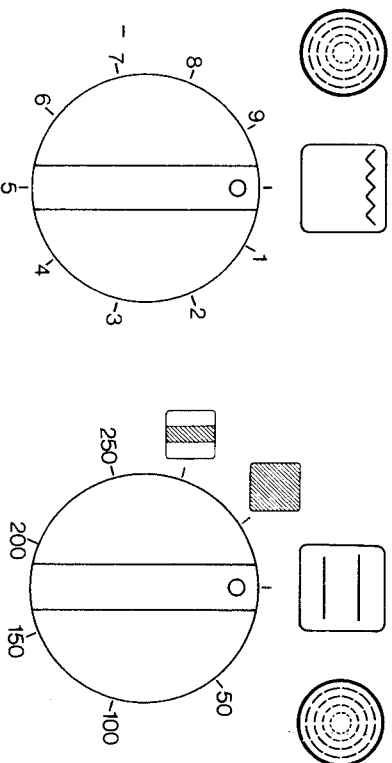

First of all switch off the mains supply to the oven. The protective cap A can be removed by turning it anti-clockwise. The bulb can then be unscrewed and replaced by one of a similar type (Part No. 613236) which can be obtained from your nearest Hotpoint Service Office (see back of handbook). After replacing the bulb reassemble the protective cap A with metal gasket B and screw back into position.

## LOWER OVEN CONTROLS



To heat this oven, turn the Lower Oven Thermostat  clockwise to the required temperature. The red Thermostat Light will immediately come on and remain on until the oven reaches the selected temperature. The light will then cycle on and off during cooking as the Lower Oven maintains this temperature.

After use always turn the Lower Oven control anticlockwise back to 'O' (off). To use the grill set the Lower Thermostat to either the economy power grill  or the full power grill , and then set the Variable Grill Control  within the range 1-9.

# The Controls (cont'd)

## THE AUTOMATIC OVEN TIMER

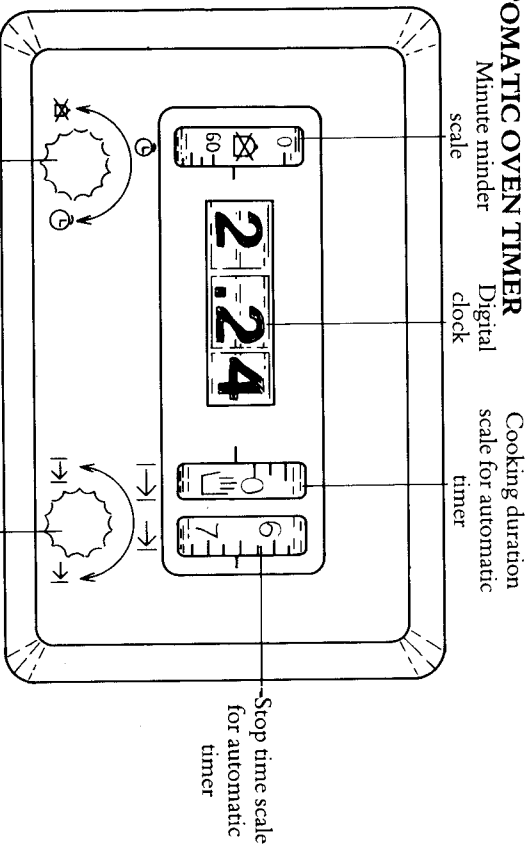

The Main Oven and the Lower Oven can be controlled by the Automatic Timer independently or both together. The Automatic Timer can be set to switch off up to 12 hours in advance and the cooking period can be anything up to 3½ hours.

The Timer is controlled by the Digital Clock. Check that the clock is showing the correct time, if not reset by pulling out the Clock Control (D) knob and turning it either clockwise or anti-clockwise until the correct time appears.

**Note:** If the clock does not operate when the appliance is switched on at the mains or after a power failure, make sure that the Minute Minder is set to .

### To set the Timer to switch ON and OFF automatically

1. Turn the Timer control knob clockwise until the time you wish the meal to finish cooking is set on the scale →.
2. Turn the Timer control knob anti-clockwise until the length of time you want the meal to cook is shown on the scale →.
3. Turn the Oven Thermostat(s) to the required temperature.
4. The oven(s) will automatically be switched ON and remain on for the pre-selected cooking period. The oven(s) will switch OFF when the stop time has been reached.
5. After use turn the Oven Thermostat(s) to 'O' (off) and the Timer Control knob clockwise so that the setting  (Manual) is displayed on the Cooking Duration Scale.

### Cleaning the Lower Oven door.

The Lower Oven door can also be removed for easier cleaning. To do this open the door fully and block hinges A and B by fitting the two inserts  as indicated in Figure 1.

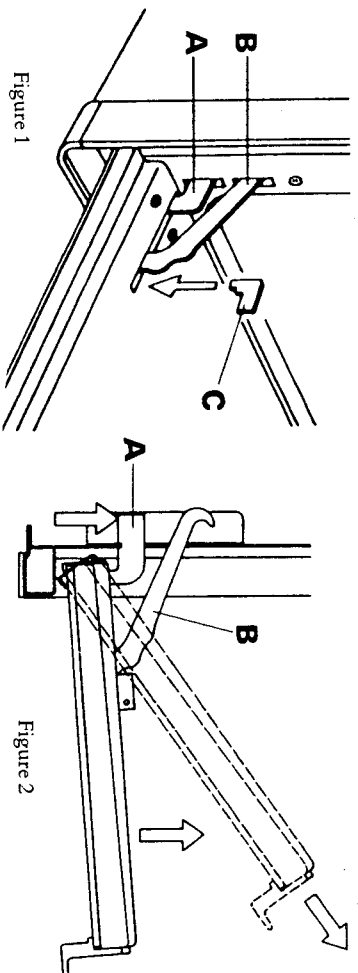

Once this has been done move the door upwards to an angle of 45° lifting hinge A with your index finger, remove the door by carrying out the movements illustrated in Figure 2. When removing the door you should hold it at each side close to the hinges. The door can then be cleaned in the same way as for the Main Oven door.

To reassemble, simply replace the hinges into the slots, ensuring the grooves in the lower hinges A are correctly positioned. To locate these grooves place your hand at the base of the oven door and manipulate into position. Open the door fully and remove inserts C which were used to block the hinges. The door can then be closed.

### Interior Oven Cleaning and Maintenance

The oven should be cleaned immediately after use, when it is still warm and the stains are easy to remove. In the Main Oven there is a removable oven roof liner, and the metal shelf supports can be taken out by unscrewing the circular retainers. In the Lower Oven, the metal shelf supports can be removed by depressing pin A and pulling the front part of the supports upwards. Then remove the supports from the holes at the rear of the oven.

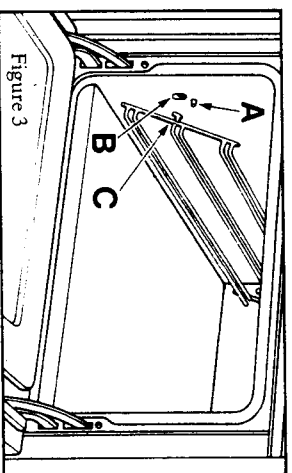

To reassemble the supports, insert them into the holes at the rear of the Lower Oven and place hook C into Slot B, pushing downwards. (See Figure 3.) The interior of both ovens, the 'furniture' and the metal shelf supports should be cleaned using a cloth and soapy water. Stubborn stains can be removed by using a fine steel wool soap pad. Rinse and dry with a soft cloth.

**Note:** Abrasive cleaners, oven sprays or pads should not be allowed to come into contact with the oven surround or trims.



# Caring for your Double Oven

Before doing any cleaning always check that the electricity supply to the oven is switched OFF.

## Cleaning the Outside

The outside of both ovens can be cleaned using a cloth which has been rinsed in warm soapy water. The oven can then be wiped down with a clean dry cloth. Never use an abrasive powder as this will damage the surface. Any discolouration of the Lower Oven handle caused by steam from the vent opening can be cleaned with a cloth moistened with mineral oil.

## Cleaning the Main Oven Door

The main oven door may be removed for easier cleaning. To do this, open the door and place metal clips B (which are situated on the top of hinge A), onto the small hook on the underside of hinge C. Once this has been done, the door can be lifted and removed by carrying out the two movements illustrated in the diagram below. Hold the sides of the door near the hinges.

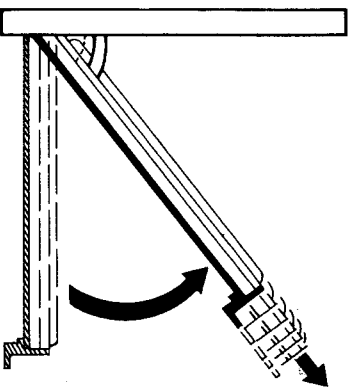
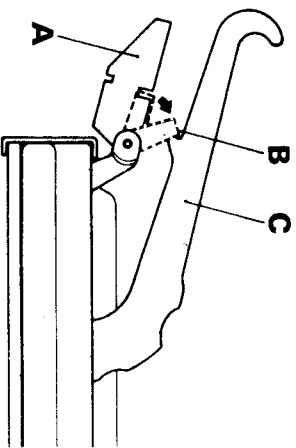

ensuring the grooves in the lower hinges A are correctly positioned. Remove the metal clips B and return to their original position. The door can then be closed.

Stubborn stains on the inside of the doors can be removed by using a liquid cleaner eg. Jif. During cleaning the doors must not be immersed in water. Do not use scouring pads or abrasive powder which will scratch the glass. Cleaners which contain bleach should not be used as they may dull the surface. After cleaning, rinse and dry with a soft cloth.

To reassemble simply replace the hinges into the locating holes

## To set the Timer to switch OFF only

The timer may be used to switch the Main or Lower Oven off providing the cooking period does not exceed 3½ hours.

1. Turn the Oven Thermostat(s) to the required temperature.
2. Turn the Timer Control knob clockwise until the time you wish the meal to finish cooking is set on the scale →.
3. Turn the Timer Control anti-clockwise so that the cooking duration is shown on the scale →.
4. The Oven(s) will automatically switch off when the stop time has been reached.
5. After use turn the Oven Thermostat(s) to 'O' (off) and turn the Timer Control clockwise so that (Manual) is displayed on the Cooking Duration Scale.

## To cancel the Timer and return to MANUAL operation

If you wish to use the oven manually after a timed operation has been set, turn the Timer Control knob clockwise until (Manual) is displayed on the Cooking Duration Scale.

**Important:** After cooking automatically **always** make sure that the Timer has been set to (Manual) operation (turn the Timer Control knob clockwise).

## Minute Minder

The Minute Minder operates independently of the Automatic Timer and will give an audible reminder for periods of up to 60 minutes. It does not control the operation of the oven.

Turn the Minute Minder Control knob clockwise (do not pull it) and set the required time on the scale (D). The scale will run back to 'O' and a bell will ring. To switch off the bell, turn the Minute Minder Control knob anti-clockwise until the scale is at (X).

**WARNING:** The variable grill can be controlled by the Automatic Oven Timer. It is very dangerous to leave unattended any food under the grill. The timer must not be used to control the grill.

# Cooking in the Main Oven

The temperatures given in the baking and roasting charts on the following pages are intended as a guide. You may find that you will need to vary these to suit your personal taste.

**IMPORTANT:** Whichever method of cooking you are using you should **never** cook directly on the floor of the oven. If using aluminium foil, **never** allow it to touch the sides of the oven. **Never** cover the oven interior or shelves with foil.

## Position of shelves

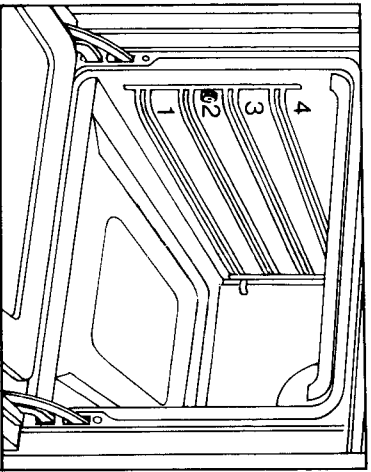

To obtain the best results it is recommended that you use the oven furniture provided whenever possible.

Only put in the shelves or fittings you actually want to use. Unused shelves only restrict access and get in the way. If possible it is a good idea to remove the fittings when you have finished cooking so that the next time you come to use the oven you do not inadvertently heat up unnecessary shelves or tins – as well as being more convenient this will save electricity.

## Baking, Roasting and Defrosting in the fan assisted Main Oven

### Baking

The advantage of this method of cooking is that the oven heats up more quickly and evenly, and that generally food can be cooked at a lower temperature than in a conventional oven. Pre-heating of the oven is only required if the cooking time is less than 25 minutes.

As the distribution of heat is more even, most foods will cook satisfactorily in any shelf position, but the shelves should be evenly spaced. If only one shelf is being used then position 1 is preferable. Temperatures selected should be 10 to 30°C lower than with conventional heating – see separate cookery book.

It is possible to grill with the oven door open. The deflector, situated between the Upper and Lower Ovens, should always be

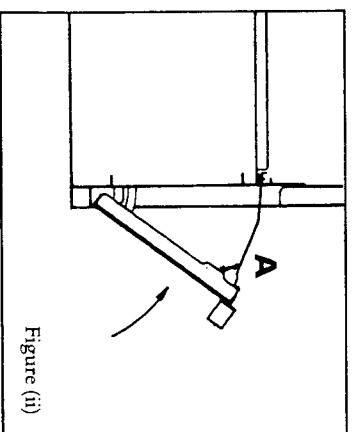

Figure (ii)

## Warming Dishes

The Lower Oven is ideal for warming dishes and keeping food hot. Dishes should not be placed directly on the floor of the oven and the Lower Oven Thermostat should not be set above 75°C.

Take care, particularly with delicate tableware.

**IMPORTANT:** If using aluminium foil **never** allow the foil to touch the sides of the oven. **Never** cover the oven interior or shelves with foil.

## Temperature Conversion Scale

The Oven Thermostats are marked in degrees Centigrade. This chart will help when recipes show the alternative Fahrenheit scale or such terms as 'Slow', 'Moderate' and 'Hot' oven are used. **IMPORTANT:** When using the Main Fan-Assisted Oven remember that the oven temperature should be 10-30°C lower than stated for conventional heating.

Oven Temperature Guide	Centigrade Scale	Fahrenheit Scale
Cool	70°C	150°F
	80°C	175°F
	100°C	200°F
	110°C	225°F
Slow	120°C	250°F
	140°C	275°F
	150°C	300°F
Moderate	160°C	325°F
	180°C	350°F
Fairly Hot	190°C	375°F
	200°C	400°F
Hot	220°C	425°F
	230°C	450°F
Very Hot	240°C	475°F
	250°C	500°F
	260°C	525°F

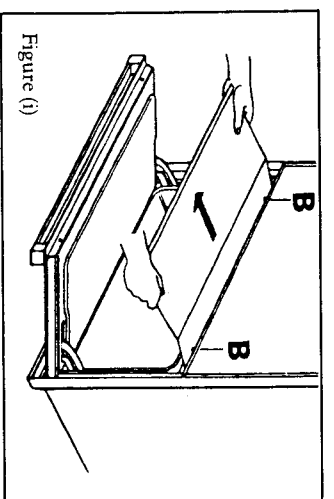

Figure (i)

used. Open the Lower Oven door, pull the deflector out and insert onto pins B (see Figure (i)). The Lower Oven door can then be raised until it leans against the deflector as shown in Figure (ii).

## Baking Chart

Food	Temperature °C	Shelf Position
Scones	190-210	1
Soufflé	180-200	1
Apple tart	170-180	1
Swiss roll	160-170	1
Victoria sandwich	160-180	1
Rich fruit cake	130-140	1
Meringues	75	1
Fairy cakes	170-190	1

\* Reversible wire shelf with wires uppermost.





## Roasting Chart

Food	Temperature °C	Shelf Position
Beef	170-180	1
Lamb	160-180	1
Pork	160-170	1
Turkey	175-190	1
Chicken	175-190	1
Duck/Goose	170-190	1

\* Reversible wire shelf with wires uppermost.

## Variable Grilling

The grilling facility in the lower oven enables you to use the full width of the grill or just the middle section depending on the amount of food you wish to grill at one time.

To use the full width of the grill turn the Lower Oven Control knob to , and for economy grilling turn it to . In both positions the grill power can be adjusted by means of the Variable Grill Control  (settings 1-9). To switch the oven or the grill off, turn the Lower Oven Thermostat  to 'O'.

Grilling can be done with the Lower Oven door closed. There is no need to pre-heat. The grill pan with the grid should be used at shelf positions 2 or 3, according to the thickness of the food. If excessive smoke is being emitted then turn the Variable Grill Control to a lower setting and/or move the grill pan to a lower position.

When cooking a complete meal eg. roast beef, roast potatoes, Yorkshire pudding and apple pie, place the meat and the potatoes on the wire grid in the grill/meat pan at shelf position 1, with the apple pie and Yorkshire pudding at shelf position 3.

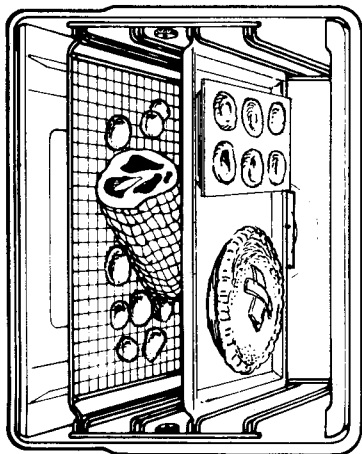

When all three shelves are used to cook large quantities of food for home freezing or parties, it may be necessary to increase the cooking times by a few minutes to allow for the larger mass of food.

If you are batch cooking you will need to pre-heat the oven. When baking on two shelves use positions 1 and 3, and when baking on three shelves use positions 1, 2 and 3.

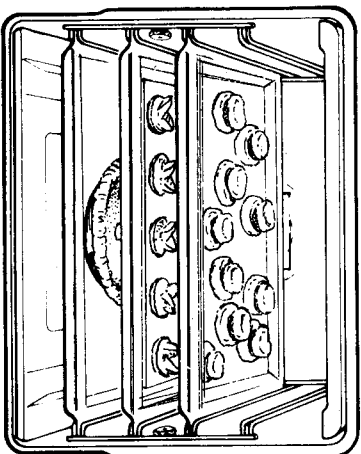

## Baking Chart

Food	Temperature °C	Shelf Position
Bread	200-220	1-2
Scones	200-220	1-2
Soufflé	175-200	1-2
Apple tart	175-200	1-2
Swiss roll	150-175	1-2
Victoria sandwich	150-175	1-2
Rich fruit cake	125-150	1
Meringues	75	1-2
Fairy cakes	170-190	1-2

## Roasting

This oven with its hot air circulation alters traditional ideas about roasting acquired when using a conventional oven. It is no longer necessary to turn and baste your meat during roasting, all you need to do is place the meat on the grill shelf positioning this as near to the centre of the oven as possible (shelf position 2). Always place a drip tray directly beneath the grill shelf (shelf position 1).

Meat roasting temperatures should not exceed 180-190°C as this will cause the meat to burn and excessive splashing to occur.

If you want to roast your meat in the pan provided or in a roasting tin, you can use the same oven temperature as for roasts placed on the grill shelf, but cooking time will be longer and the meat will require basting.

Frozen meat must be thawed thoroughly either using the Main Oven (see Defrosting) or at room temperature before being roasted, especially chicken and turkey. Red meat will continue to cook even after it has been removed from the oven. It is therefore advisable to let the meat rest for about a quarter of an hour before carving and eating it.

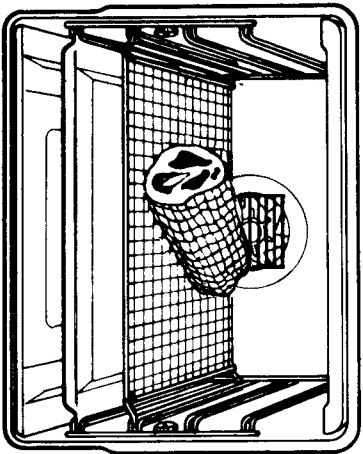

## Roasting Chart

Food	Temperature °C	Shelf Position
Beef	150-160	2
Lamb	150-160	2
Pork	150-160	2
Turkey	150-160	2
Chicken	160-170	2
Duck/Goose	160-170	2

For further information see Recipe Booklet.

## Defrosting

Food can be defrosted in the main oven as though it was thawing at room temperature, with the advantage that it is much quicker.

The Oven Thermostat should be set at  and the food for defrosting placed on a tray. **No heat is required for defrosting.**

# Cooking in the Lower Oven

The lower oven can be used for normal cooking, but on a smaller scale. The oven is heated by an element at the top and a lower element under the base of the compartment. It is recommended that only one shelf position is used when baking or roasting (preferably shelf position 1). **Never** place food on the Oven floor. Where necessary, it is advisable to stand dishes on a baking tray to avoid spillage onto the floor of the oven. Most foods will cook at a slightly lower temperature in this smaller oven than in the larger main oven.

The temperatures given in the baking and roasting charts are intended as a guide. You may find that you need to vary these to suit your personal taste.

When the oven is in use for extended periods the glass door can become hot.

## Position of Shelves

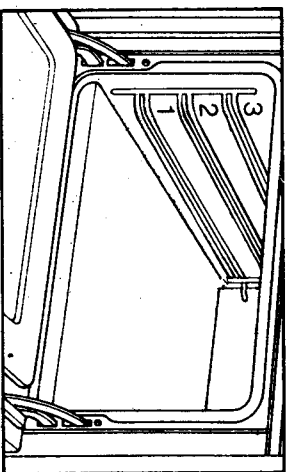

## Baking and Roasting using Conventional Heat

Turn the Lower Oven Thermostat  to the required temperature. It is necessary to preheat the oven before use.

## Baking

Always place the item you are baking in a central position on the shelf.

## Roasting

Always try to use roasting tins with high sides to avoid soiling the oven walls.



## Key Contacts

### **After Sales Service**

Over 1100 trained specialists, directly employed by us, ensure that you have complete confidence in both the appliances and services we offer.

#### **Repair Service**

UK: 08709 066 066

(Open 8 to 8 Mon - Fri, 8 to 6 Sat & 10 to 4 Sun)

[www.theservicecentre.co.uk](http://www.theservicecentre.co.uk)

Republic of Ireland: 1850 302 200

Note: Our Service Operators will require the following information:

Model Number

Serial Number

#### **Extended Warranties**

UK: 08709 088 088

(Open 8 to 6 Mon - Fri)

[www.theservicecentre.co.uk](http://www.theservicecentre.co.uk)

Republic of Ireland: 1850 502 200

#### **Genuine Parts and Accessories**

UK: 08709 077 077

(Open 8-30 to 5-30 Mon - Fri, 8-30 to 12 Sat)

[www.theservicecentre.co.uk](http://www.theservicecentre.co.uk)

Republic of Ireland: (01) 842 6836

General Domestic Appliances Limited, Morley Way, Peterborough, PE2 9JB

## Free Manuals Download Website

<http://myh66.com>

<http://usermanuals.us>

<http://www.somanuals.com>

<http://www.4manuals.cc>

<http://www.manual-lib.com>

<http://www.404manual.com>

<http://www.luxmanual.com>

<http://aubethermostatmanual.com>

Golf course search by state

<http://golfingnear.com>

Email search by domain

<http://emailbydomain.com>

Auto manuals search

<http://auto.somanuals.com>

TV manuals search

<http://tv.somanuals.com>