

Instructions for Installation and Use

Build-in Electric
double oven

GB

English, 2

UX 892 CX

GB

Introduction, 2
Safety Information, 3
Installation, 5
Tall Cabinet Ventilation, 6
The main parts of your Double Oven, 8
Start-up and use, 9
The Cooking Modes in your Double Oven, 11
Solarplus Grill, 14
Top Oven - Conventional Cooking, 16
Top Oven Temperature Charts - Meat, 17
Top Oven Temperature Charts - Baking, 18
Main Oven - The Intelligent Cooking System, 19
Temperature Conversion Chart, 21
Care and Cleaning, 22
If something goes wrong...,25
Disposal of the appliance, 26
Guarantee Information, 27
Service Information, 28

 **Hotpoint**

Please phone us on
08448 24 24 24
to activate your
guarantee

Introduction

GB

To the Installer:

Before installation, fill in the product details on the back cover of this book.
The information can be found on the rating plate.

To the User:

You must read the instructions prior to installing and using the appliance and then retain them for future reference.

! Before operating your new appliance please read this instruction booklet carefully. It contains important information concerning the safe operation, installation and maintenance of the appliance.

! Please keep these operating instructions for future reference. Pass them on to possible new owners of the appliance.

Retention of this Instruction Book

This Instruction Book must be kept handy for reference as it contains important details on the safe and proper use of the appliance.

If you sell or pass the appliance to someone else, or move house and leave it behind, make sure this Book is also provided so the new owner can become familiar with the appliance and safety warnings.

Your new appliance is guaranteed* and will give lasting service. This guarantee is only applicable if the appliance has been installed in accordance with the installation instructions detailed in this booklet. To help make best use of your cooking equipment, please read this booklet carefully.
The appliance is designed specifically for domestic use and responsibility will not be accepted for use in any other installation.

When the cooker is first used an odour may be emitted, this will cease after a period of use

To help remove the 'new' smell, heat up the empty ovens to maximum temperature for a minimum of two or three hours, keeping the oven doors closed. Ensure that the room is well ventilated (e.g. open a window or use an extractor fan) and that persons who may be sensitive to the odour avoid any fumes. It is suggested that any pets be removed from the room until the smell has ceased.

This odour is due to temporary finish on oven liners and elements and also any moisture absorbed by the insulation.

*** The guarantee is subject to the provisions that the appliance:**

- (a) **Has been used solely in accordance with the Users Instruction Book.**
- (b) **Has been properly connected to a suitable supply voltage as stated on the rating plate attached to this equipment.**
- (c) **Has not been subjected to misuse or accident or been modified or repaired by any person other than the authorised employee or agent.**
- (d) **Has been correctly installed.**



This appliance conforms with the following European Economic Community directives:

- 2006/95/EC of 12/12/06 (Low Voltage) and subsequent modifications;
- 2004/108/EC of 15/12/04 (Electromagnetic Compatibility) and subsequent modifications;
- 90/396/EEC of 29/06/90 (Gas) and subsequent modifications (only for models which use gas);
- 93/68/EEC of 22/07/93 and subsequent modifications.
- 2002/96/EC
- 1275/2008 (Stand-by/Off mode)

Technical Characteristics

Top Oven

Usable Volume: 27 Litres

ENERGY LABEL - Top Oven

Directive 2002/40/EC on the label of electric ovens
Norm EN 50304

Declared energy consumption for
Natural convection Class

heating mode: Conventional

Main Oven

Usable Volume: 51 Litres

ENERGY LABEL - Main Oven

Directive 2002/40/EC on the label of electric ovens
Norm EN 50304

Declared energy consumption for
Natural convection Class

heating mode: Fan Oven 

Voltage and Frequency

230-240V~ 50Hz

- **WARNING:** The appliance and its accessible parts become hot during use.
- Care should be taken to avoid touching heating elements.
- Children less than 8 years of age shall be kept away unless continuously supervised.
- This appliance can be used by children aged from 8 years and above and persons with reduced physical, sensory or mental capabilities or lack of experience and knowledge if they have been given supervision or instruction concerning use of the appliance in a safe way and understand the hazards involved. Children shall not play with the appliance. Cleaning and user maintenance shall not be made by children without supervision
- During use the appliance becomes hot. Care should be taken to avoid touching heating elements inside the oven.
- **WARNING:** Accessible parts may become hot during use. Young children should be kept away.
- Do not use harsh abrasive cleaners or sharp metal scrapers to clean the oven door glass since they can scratch the surface, which may result in shattering of the glass
- When cleaning the appliance do not use steam cleaner.
- **WARNING:** Ensure that the appliance is switched off before replacing the lamp to avoid the possibility of electric shock
- The appliance is not intended to be operated by means of an external timer or separate remote-control system.

When used properly your appliance is completely safe but as with any electrical product there are certain precautions that must be observed. PLEASE READ THE PRECAUTIONS BELOW BEFORE USING YOUR APPLIANCE.

Always

- Always make sure you remove all packaging and literature from inside the oven and grill compartments before switching on for the first time.
- Always make sure you understand the controls prior to using the appliance.
- Always keep children away from the appliance when in use as the surfaces will get extremely hot during and after cooking.
- Always make sure all controls are turned off when you have finished cooking and when not in use.
- Always stand back when opening an oven door to allow any build up of steam or heat to disperse.
- Always use dry, good quality oven gloves when removing items from the oven/grill.
- Always take care to avoid heat/steam burns when operating the controls.
- Always turn off the electricity supply at the wall switch before cleaning and allow the appliance to cool.
- Always make sure the shelves are in the correct position before switching on the oven.
- Always keep the oven and grill doors closed when the appliance is not in use.
- Always take care when removing utensils from the top oven when the main oven is in use as the contents may be hot.
- Always keep the appliance clean as a build up of grease or fat from cooking can cause a fire.
- Always follow the basic principles of food handling and hygiene to prevent the possibility of bacterial growth.
- Always keep ventilation slots clear of obstructions.
- Always refer servicing to a qualified appliance service engineer.
- During use the oven becomes hot. Care should be taken to avoid touching heating elements inside the oven.

! The appliance must be used by adults only for the preparation of food, in accordance with the instructions outlined in this booklet. Any other use of the appliance (e.g. for heating the room) constitutes improper use and is dangerous. The manufacturer may not be held liable for any damage resulting from improper, incorrect and unreasonable use of the appliance.

SAFETY ADVICE IN THE EVENT OF A CHIP PAN OR ANY OTHER PAN FIRE:

1. TURN OFF THE COOKER APPLIANCE AT THE WALL SWITCH.
2. COVER THE PAN WITH A FIRE BLANKET OR DAMP CLOTH, this will smother the flames and extinguish the fire.

3. LEAVE THE PAN TO COOL FOR AT LEAST 60 MINUTES BEFORE MOVING IT. Injuries are often caused by picking up a hot pan and rushing outside with it.

Never

- Never leave children unsupervised where a cooking appliance is installed as all cooking surfaces will be hot during and after use.
- Never allow anyone to sit or stand on any part of the appliance.
- Never store items above the appliance that children may attempt to reach.
- Never remove the oven shelves whilst the oven is hot.
- Never heat up unopened food containers as pressure can build up causing the container to burst.
- Never store chemicals, food stuffs or pressurised containers in or on the appliance, or in cabinets immediately above or next to the appliance.
- Never operate the grill with the door closed as this will cause the appliance to overheat.
- Never use the appliance as a room heater.
- Never use the grill to warm plates.
- Never dry any items on the oven doors.
- Never install the appliance next to curtains or other soft furnishings.
- Never allow children to play with the appliance controls.
- Never use 'steam cleaners'.

Children should be supervised to ensure that they do not play with the appliance.

! The appliance should not be operated by people (including children) with reduced physical, sensory or mental capacities, by inexperienced individuals or by anyone who is not familiar with the product. These individuals should, at the very least, be supervised by someone who assumes responsibility for their safety or receive preliminary instructions relating to the operation of the appliance.

NOTICE

VERY HOT SURFACES

Food or grease on these surfaces could cause smoke and possibly even burn

YOU MUST KEEP THE OVEN AND GRILL CAVITIES CLEAN

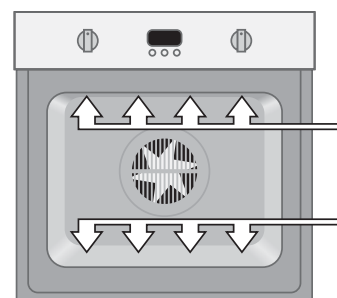

Installation

GB

Electrical Requirements

For your own safety, we recommend that your cooker is installed by a competent person such as one who is registered with NICEIC (National Inspection Council for Electrical Installation Contracting). The cooker should be installed in accordance with the latest edition of the IEE Regulations.

Warning: This appliance must be earthed.

Electrical Connections

The installer must check that the voltage shown on the rating plate corresponds with the house electricity supply. The cooker must be supplied via a suitable double pole isolating switch, having a contact separation of at least 3mm in all poles placed in a readily accessible position adjacent to the cooker. If the cooker is to be wired into a connector unit, this may be positioned behind the cooker providing the following requirements are met:

- The connector unit must not project from the wall more than 25mm.
- The top of the connector must not be more than 130mm above floor level.

Remove the terminal cover at the rear base of the cooker. Pass the cable through the cable clamp and connect to the appropriate terminals provided. Allow sufficient cable for any future servicing. Tighten the screws on the cable clamp and replace the cover. Make main connections in the connector unit or cooker control unit. This appliance conforms to B.S. EN 55014 regarding suppression of Radio and Television reception interference.

A double Pole control switch having a minimum rating of 32 amps should be used to feed the cooker using a suitably rated cable. Where a hob is fitted adjacent to or over the cooker, a 45 amp Double Pole control switch should be used to feed both units via separate suitably rated cables.

We recommend a minimum of 4mm² PVC insulated twin and earth cable conforming to B.S. 6004 for connection of each appliance.

In all cases adhere to routing details (see fig. 5).

This appliance must not be installed over any other appliance that generates heat such as a plinth heater.

Note: Due to many different types of installation, a mains cable is not supplied with this product. The installer will fit the correct type and length of cable.

GENERAL

The appliance is designed to be mounted on a floor between two adjacent cabinets.

The cabinets must be securely fixed to the wall and the cooker securely fixed to the cabinets.

This cooker must not be used free standing.

Note; This cooker must not be fitted on a platform.

FINAL INSTALLATION

- Ensure that the adjacent cabinets and the gap between them have dimensions in accordance with the diagram.
- Assemble the plastic plugs provided into the fixing brackets. See diagram.
- Fix the fixing brackets to the sides of the adjacent cabinets so that the centre line of the brackets are 570mm above the top of the plinth line and the front face of the plastic plug is level with the front face of the cabinet sides. See diagram.
- Adjust the feet on the cooker to their minimum position, i.e. fully screwed in.
- Slide the cooker centrally into the space between the cabinets ensuring the following:
 - The gap between the cabinet sides and the cooker is even along the length of the cabinet sides.
 - The cable is routed away from any vents in the rear panel and is not trapped between the cooker and the wall, adjacent cabinets or under the feet.
- Adjust the feet using an open ended spanner until the bottom of the cooker door is in line with the top of the plinth. Using a spirit level, check that the cooker is level in all directions.
- Check that the plinth can be fitted. If necessary re-adjust the feet and check that the cooker is level. Then lock the feet into position by tightening the lock nut using an open ended spanner.
- Open the top oven door and fix the cooker to the brackets through the holes in the side trims.
- Fix the plinth in position.
- Ensure that there is a minimum gap of 1mm between the cooker side trim and the adjacent cabinet doors or drawer fronts.
- If a hob is to be installed directly above the cooker it must not project downwards more than 20mm below the underside of the work top. Any projection of more than 10mm must not project more than 500mm from the wall.

Fig. 5

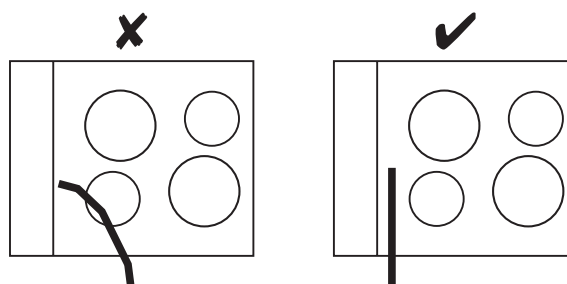

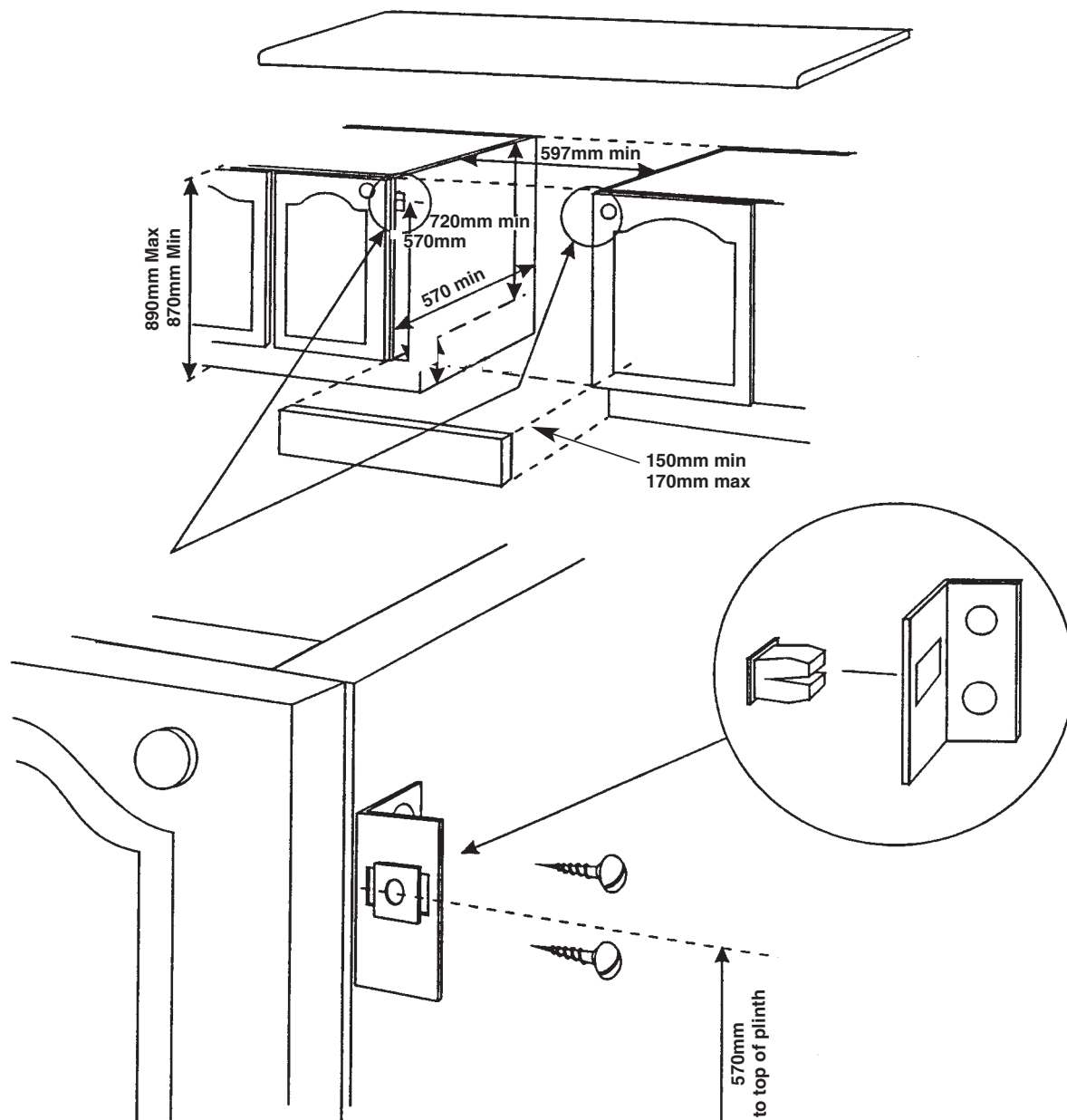

A minimum distance of 25mm should be maintained between the front face of the cabinet side and the front face of the plinth.

Installation

GB

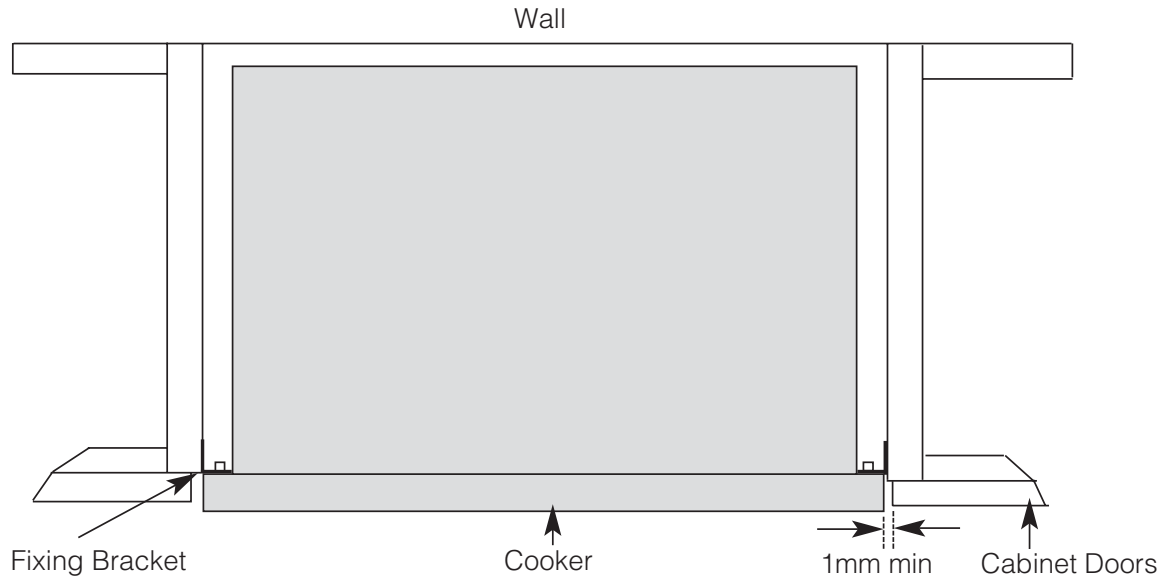

Top View

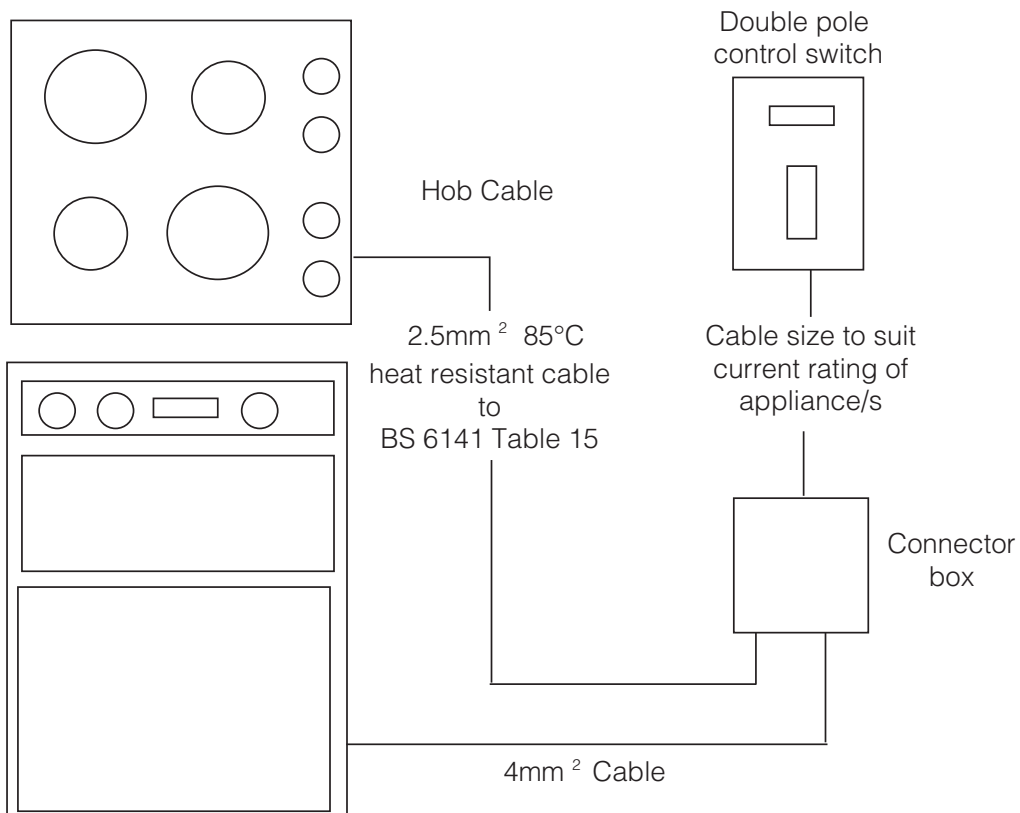

The main parts of your Double Oven

Overall view

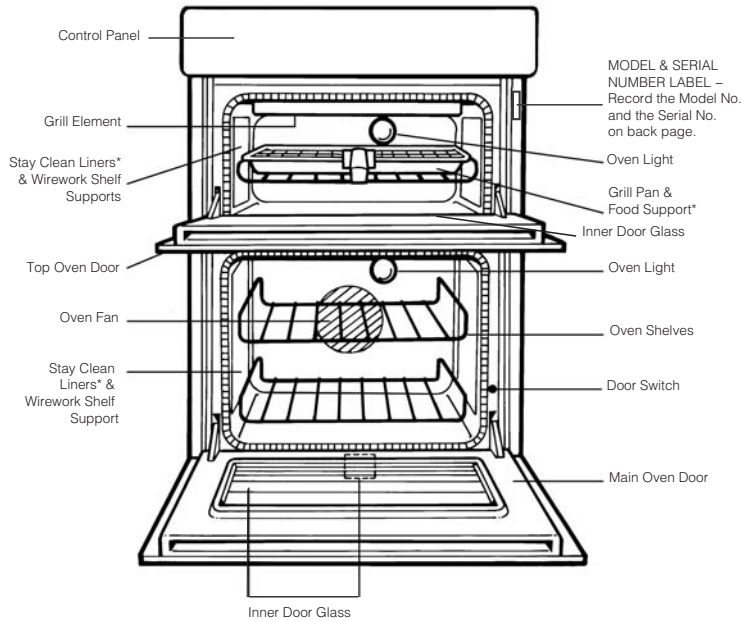

Control panel

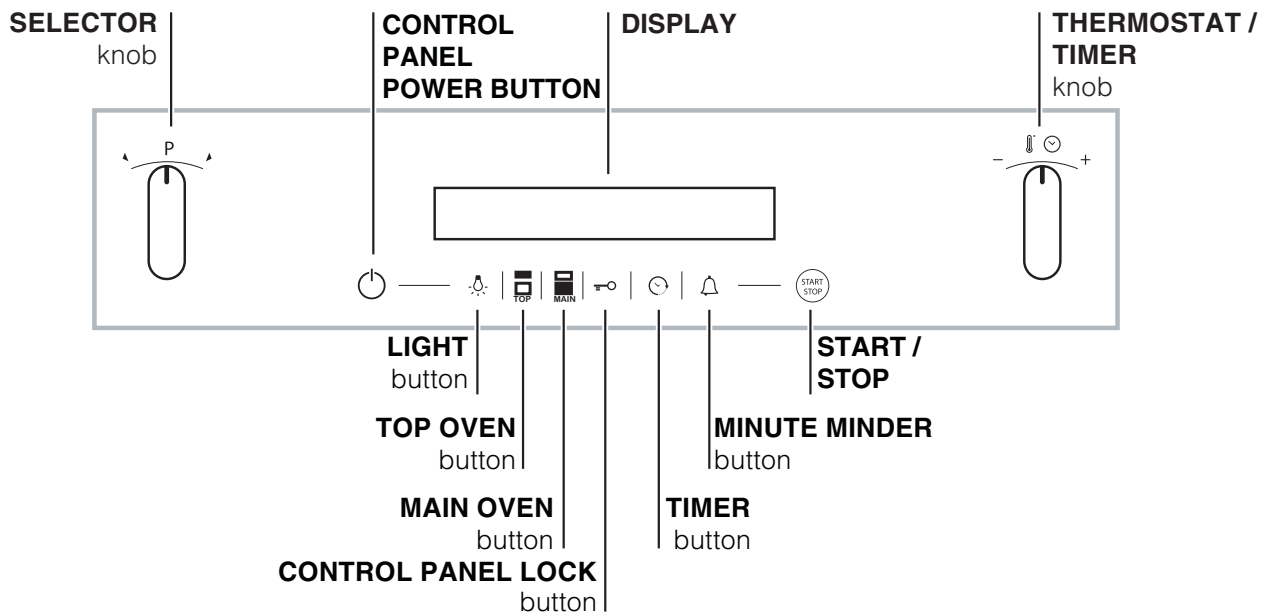

Display

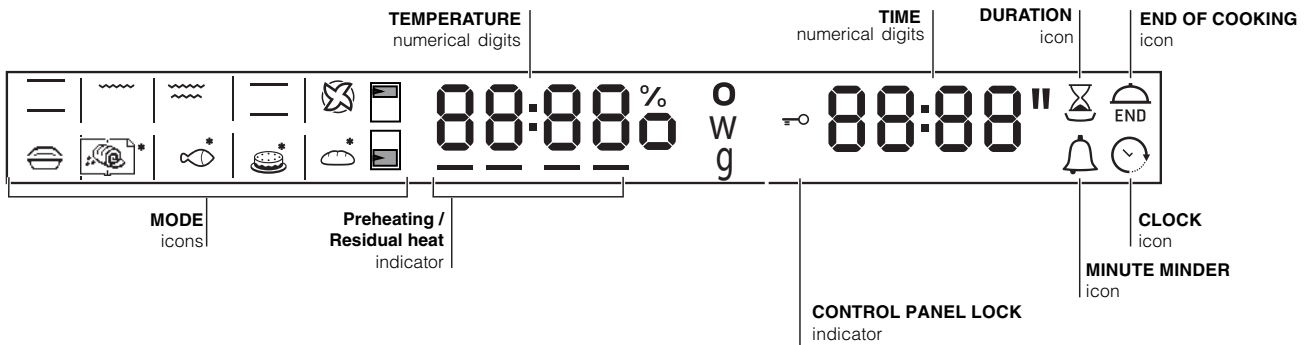

*Available only on certain models

Start-up and use

GB

! The first time you use your appliance, heat the empty oven with its door closed at its maximum temperature for at least two hours. Ensure that the room is well ventilated before switching the oven off and opening the oven door. The appliance may emit a slightly unpleasant odour caused by protective substances used during the manufacturing process burning away.



! To make the setting process easier, keep the knob in position: this will increase the scrolling speed of the numbers on the display.

! Each setting will automatically be stored in the appliance memory after 10 seconds.

! The touch controls cannot be activated if the user is wearing gloves.

Control panel lock

! The control panel can be locked during the cooking as well as once the cooking has finished.

To lock the oven controls, press and hold the  button for at least 2 seconds. A buzzer will sound and the TEMPERATURE display shows the key symbol "O—n". The  icon will light up to indicate lock activation.

To deactivate the lock, press and hold the  button again for at least 2 seconds.

Setting the clock



! The clock can only be set when the oven is switched off. If the oven is in standby mode,

pressing the  button once will display the current time setting. Press it again to set the time.

After connection to the power supply network or after

a blackout, the  button on the display will flash for 10 seconds.

To set the clock:

1. Press button .
2. Turn the TIMER knob towards "+" and "-" to adjust the hour value.
3. Once you have reached the correct hour value, press the  button.



4. Repeat the above process to set the minutes. If a blackout occurs, it will be necessary to reset the clock. If the  icon flashes on the display, this indicates that the clock has not been set correctly.

Setting the minute minder



! The minute minder may still be set whether the oven is switched on or off. It does not switch the oven on or off.

When the set time has elapsed, the timer emits a buzzer that will automatically stop after 30 seconds or when any active button on the control panel is pressed.

To set the minute minder proceed as follows:

1. Press button .
2. Adjust the time as desired by turning the TIMER knob towards "+" and "-".
3. Once you have reached the desired value, press the  button again.

The lit  symbol will remind you that the minute minder is on. The DISPLAY will show the countdown.

To cancel the minute minder, press the  button and use the knob to set the time to 00:00. Press button  again.

The  icon will switch off to indicate that the minute minder has been disabled.

Starting the oven

1. Switch the control panel on by pressing the  button. The appliance buzzer sounds three times (ascending) and all buttons light up in sequence.
2. Select the TOP/GRILL or MAIN oven by pressing the

 TOP OVEN/ GRILL or MAIN OVEN  icon.

3. Select the desired cooking mode by turning the SELECTOR knob. The display shows:
 - the temperature associated with the mode, if programming manually;

- "Auto" and the duration alternately, if programming is automatic.

4. Press the  button to begin cooking.
5. The oven will begin its preheating phase, the preheating indicators will light up as the temperature rises.

6. When the preheating process has finished, a buzzer sounds and all the preheating indicator lights show that this stage has been completed: the food can then be placed in the oven.

7. During cooking it is always possible to:
- modify the temperature by turning the

THERMOSTAT knob (*manual modes only*);

- set the duration of a cooking mode (*see Cooking Modes*);

- press the  button to stop cooking. In this case the appliance stores the temperature modified previously in its memory (*manual modes only*);

- switch off the oven by pressing the  button for 3 seconds.

8. If a blackout occurs while the oven is already in operation, an automatic system within the appliance will reactivate the cooking mode from the point at which it was interrupted, provided that the temperature has not dropped below a certain level. Programmed cooking modes which have not yet started will not be restored and must be reprogrammed (for example: a cooking mode has been programmed to start at 20:30. At 19:30 a blackout occurs. When the power supply is restored, the mode will have to be reprogrammed).

- ! There is no preheating stage for the GRILL mode.
- ! Never put objects directly on the bottom of the oven; this will prevent the enamel coating from being damaged.
- ! Always place cookware on the rack(s) provided.

Cooling ventilation

In order to cool down the external temperature of the oven, a cooling fan blows a stream of air between the control panel and the oven door, as well as towards the bottom of the oven door.

! Once cooking has been completed, the cooling fan continues to operate until the oven has cooled down sufficiently.

Oven light

The light comes on when the oven door is opened or when a cooking mode starts.

The  button can be used to switch on/ switch off the light at any time.

Residual heat indicators

The appliance is fitted with a residual heat indicator. When the oven is off, the "residual heat" bar on the display lights up to indicate high temperatures inside the oven cavity. The individual segments of the bar switch off one by one as the temperature inside the oven falls.

Restoring the factory settings

The oven factory settings can be restored to reset all selections made by the user (clock and customised durations). To carry out a reset, switch off the oven, then keep the SELECTOR knob turned while

pressing the  button for 6 seconds. Once the restore procedure is complete, a buzzer will sound.

The first time the  button is pressed, the oven will behave as if it is being switched on for the first time.

Standby

This product complies with the requirements of the latest European Directive on the limitation of power consumption of the standby mode. If no buttons are pressed for 30 minutes and the control panel lock has not been activated, the appliance automatically reverts to standby mode. The standby mode is visualised by the high luminosity "Watch Icon". As soon as interaction with the machine resumes, the system's operating mode is restored.

The Cooking Modes in your Oven

GB

Your new appliance is equipped with a number of different cooking modes:

Manual cooking modes

! All cooking modes have a default cooking temperature which may be adjusted manually to a value between 30°C and 250°C for TOP OVEN, between 80°C and 230°C for MAIN OVEN, for GRILL mode- from 5% to 100%.

When the temperature in the oven has reached a certain level and

the newly selected temperature is lower than the temperature inside the oven, the text "Hot" appears on the display. However, it will still be possible to start cooking.

Conventional Heating (Top Oven)

- with upper and lower heat. This system is particularly suitable for roasting and baking on one shelf only.

Variable Grilling (Top Oven)

- the oven can also be used for conventional grilling with a full or half width fully controllable grill.

Note: The Top Oven door should be fully open when grilling. Temperature level can be modified in this mode.

Traditional (Main Oven)

- the upper and rear heating elements are switched on in this position. The traditional oven brings an outstanding level of temperature distribution and reduced consumption. In traditional cooking use only one rack to ensure good heat distribution. By using the various shelf positions available you can balance the quantity of heat between the upper and lower part. If cooking requires more heat from below or above, use the lower or higher shelves respectively.

MULTILEVEL mode (Main Oven)

Since the heat remains constant throughout the oven, the air cooks and browns food in a uniform manner. A maximum of two racks may be used at the same time.

Rising (Main Oven)

- this mode heats and holds the oven at 35-40°C. It is ideal for proving bread and yeast based dough mixtures.

Automatic cooking modes

C.O.P.® (Programmed Optimal Cooking) system. The cooking cycle stops automatically and the oven indicates when the dish is cooked. You may start cooking whether the oven has been **preheated** or **not**. The cooking duration can be customised according to personal taste by modifying the relevant value - before cooking begins - by $\pm 5/20$ minutes depending on the selected programme. The duration can however be modified even once cooking has begun. If the temperature inside the oven is higher than the suggested value for the selected mode, the text "Hot" appears on the display and it will not be possible to begin cooking; wait for the oven to cool.

! When the cooking stage has been reached, the oven buzzer sounds.

! Do not open the oven door as this will disrupt the cooking time and temperature.



* BAKED CAKES mode

This function is ideal for cooking desserts which are made using natural yeast, baking powder and desserts which contain no yeast. Place the dish in the oven while it is still cold. The dish may also be placed in a preheated oven.

The maximum weight of the cake is about 700 g.



* BREAD mode

Use this function to bake bread. To obtain the best results, we recommend that you carefully observe the instructions below:

- follow the recipe;
- do not exceed the **maximum weight** of the dripping pan;
- **remember to pour 50 g (0,5 dl) of cold water into the baking tray in position 5.**
- The dough must be left to rise at room temperature for 1 – 1 ½ hours (depending on the room temperature) or until the dough has doubled in size.

Recipe for BREAD:

1 Dripping pan holding 1000 g Max, lower level
2 Dripping pans each holding 1000 g Max, medium and lower levels

Recipe for 1000 g of dough: 600 g flour, 360 g water, 11g salt, 25 g fresh yeast (or 2 sachets of powder yeast)

Method:

- Mix the flour and salt in a large bowl.
- Dilute the yeast in lukewarm water (approximately 35 degrees).

- Make a small well in the mound of flour.
- Pour in the water and yeast mixture.
- Knead the dough by stretching and folding it over itself with the palm of your hand for 10 minutes until it has a uniform consistency and is not too sticky.
- Form the dough into a ball shape, place it in a large bowl and cover it with transparent plastic wrap to prevent the surface of the dough from drying out. Select the manual LOW TEMPERATURE function on the oven and set the temperature to 40°C. Place the bowl inside and leave the dough to rise for approximately 1 hour (the dough should double in volume).
- Cut the dough into equal sized loaves.
- Place them in the dripping pan, on a sheet of baking paper.
- Dust the loaves with flour.
- Make incisions on the loaves.
- Place the food inside the oven while it is still cold.
- Start the  BREAD cooking mode.
- Once baked, leave the loaves on one of the grill racks until they have cooled completely.

* FISH mode

Use this function to cook fish with a maximum weight of 1 kg. The paper/foil package can be placed directly on the dripping pan. Place the food inside the oven while it is still cold.

ROAST MEAT mode





Use this function to cook beef, veal and lamb. Place the food inside the oven while it is still cold. The dish may also be placed in a preheated oven.

The maximum weight of the meat is about 1 kg.

Programming cooking

! A cooking mode must be selected before programming can take place.





Programming the cooking duration



1. Press the  button until the  icon and the numerical digits on the display begin to flash.
2. Turn the TIMER knob towards “+” and “-” to adjust the time as desired; keep the knob in position to scroll through the numbers more quickly and make the setting process easier.
3. Once you have reached the desired duration, press the  button again. The display will show the duration and set temperature alternately.
4. Press the  button to begin cooking.
5. When cooking has finished, “END” appears on the display and a buzzer sounds.
 - For example: it is 9:00 a.m. and a duration of 1 hour and 15 minutes is programmed. The programme will stop automatically at 10:15 a.m.

Setting the end time for a cooking mode

! A cooking duration must be set before the cooking end time can be scheduled.

! For the delayed programming to work properly, the clock should be set to the correct time.

1. Follow steps 1 to 3 to set the duration as detailed above.
2. Press the  button twice: the  icon and the numerical digits on the display will begin to flash.
3. Turn the TIMER knob towards “+” and “-” to adjust the cooking end time value.
4. Once you have reached the desired end time, press the  button again. The display will show the duration, the cooking end time and the set temperature alternately.
5. Press the  button to activate the programmed mode.

Programming has been set when the  and  buttons are illuminated. The DISPLAY shows the cooking end time and the cooking duration alternately.

6. Once cooking has finished, “END” appears on the display and a buzzer sounds.
 - For example: it is 9:00 a.m. and a time of 1 hour and 15 minutes is programmed, while the end time is set to 12:30. The programme will start automatically at 11:15 a.m.

To cancel programming press the  button.

Practical cooking advice

! Do not place racks in position 1 and 5 during fan-assisted cooking. This is because excessive direct heat can burn temperature sensitive foods.

! In the GRILL cooking mode, **place the** dripping pan in position 1 to collect cooking residues (fat and/or grease).

MULTILEVEL

- Use positions 2 and 4, placing the food which requires more heat on 2.
- Place the dripping pan on the bottom and the rack on top.

CAUTION: Accessible parts may become hot when the grill is in use - children should be kept away.

Your cooker is not fitted with a conventional type of grill. The **solarplus** grill is designed to reduce your grilling times. It is quicker because it takes less time to warm up from cold. Conventional grills require 5 minutes pre-heat before food is placed beneath them, but for normal grilling the **solarplus** grill can be used from cold without any pre-heat. However, when toasting, optimum performance is achieved by pre-heating the grill for about 1 minute.

Notes

You will notice that the grill elements are protected by a wire mesh.

This stops you from touching live parts.

DO NOT under any circumstances insert objects into the grill mesh as this could damage or break the element tubes OR if the grill is on cause an electric shock.

During use the mesh may become soiled. Do not attempt to clean it while the grill is still on. Turn the cooker off at the control unit and wait until it has cooled down before cleaning.

Care must be taken to ensure the grill mesh is not

distorted - DO NOT store the grill pan handle on the grill pan grid when the grill pan runners are on the top runner position.

There are two halves to the grill, one on the left and one on the right. You can choose to have both sides on or just the left side on.

GRILLING SHOULD NOT BE UNDERTAKEN WITH THE TOP OVEN/GRILL DOOR CLOSED

- This will cause overheating.

To operate the grill proceed as follows:

1. Open the grill/top oven door fully.
2. Position the rod shelf as recommended, in the chart below, for the food being cooked.
3. Place the grill pan on the rod shelf, ensuring it is positioned centrally under the element.
4. Never line the grill pan with aluminium foil as this may cause overheating of fat in the grill pan.

Food	Pre-heat	Shelf Position from base of oven	Setting	Approx. Cooking Time	Comments
Toasting of Bread Products	1 min.	3 or 2	Maximum 100%	3-5 minutes. Grill pan and grid.	NOTE: Position 1 is bottom runner from the base of the oven.
Small cuts of meat - Sausages, Bacon	None	3 or 2	Maximum 100% for 4 minutes, then reduce to 85-90%	10-15 minutes. Grill pan and grid.	
Chops, etc. Gammon Steaks, Chicken pieces	None	2	Maximum 100% or 6-8 minutes. reduce to 85%	25-30 minutes. Grill pan and grid.	
Fish	Whole:	2	Maximum 100%	6-8 minutes.	
	Filletts:	3 or 2	Maximum 100%	In base of grill pan.	
Fish in breadcrumbs	None	3 or 2	85-90%	10-15 minutes. Grill pan and grid.	
Pre-cooked Potato Products	None	3 or 2	85-90%	10-12 minutes.	
Pizzas	None	3 or 2	85-90%	10-15 minutes. Grill pan and grid.	
Browning of Food	1 min.	1 or 2	Maximum 100%	5-7 minutes. Dish placed directly on shelf.	

Using the grill pan kit

The grill pan handle is detachable from the pan to facilitate cleaning and storage. Fix the pan handle securely before use:

1. Fit the handle to the grill pan so that the external 'hooks' embrace the edge of the pan (fig. 1)
2. Make sure that the middle part of the handle fits exactly the protruding support of the pan (fig .2) and holds the pan from the bottom.

The food must be placed on the rack in the grill pan. Position the grill pan on top of the oven rack. The best results are achieved by placing the oven rack on the uppermost shelves. Pouring a little water into the grill pan will make the collection of grease particles more efficient and prevent the formation of smoke.

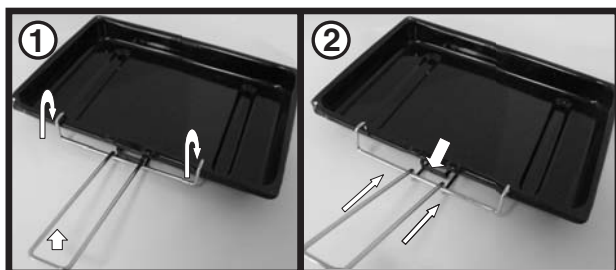

Top Oven - Conventional Cooking

 Hotpoint

The heat for conventional cooking in the top oven is provided by the grill element and the element under the floor of the oven. It is ideal for the slow cooking of cheaper cuts of meat in casseroles etc. but can also be used for small joints of meat up to 1.5kg (3lb).

See cooking charts for temperatures and shelf positioning.

The top oven can be used either independently to cook small quantities of food or in conjunction with the main oven to provide additional cooking space.

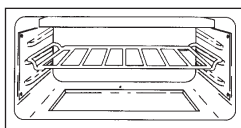

- The shelf should be positioned on the first or second runner from the bottom.

To use the oven proceed as follows:

Select the top oven, by pressing appropriate

button 

Select desired program by turning the SELECTOR knob, located to the left.

It's possible to change default temperature and default cooking duration. To change temperature turn the THERMOSTAT/TIMER knob, clockwise to increase temperature and anticlockwise to decrease the temperature.

To change the cooking duration, press the TIMER button, then turn the knob clockwise to increase and anticlockwise to decrease the cooking duration. Confirm the desired cooking duration by pressing the TIMER button again.

- The food to be cooked should be placed in the centre of the shelf with a gap of at least 25mm (1in) between it and the grill element. This should avoid burning and ensure even cooking.

- **Do not place food or dishes on the floor of the oven.**

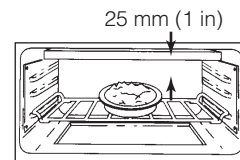

Platwarming in the top oven

Plates and dishes placed on shelf 1 of the top oven will be heated when the main oven is in use.

When the main oven is not in use, for instance when a meal is being cooked on the hob, place the plates and serving dishes on the shelf using the bottom runner and turn the top oven control to approximately 100°C. A maximum time of 10-12 minutes is all that is required to heat the plates and dishes.

NEVER operate the grill control when using the top oven for cooking or warming plates and dishes.

WARNING: DO NOT put delicate items china or items which could be affected by heat into the oven.

GB

Top Oven Temperature Charts - Meat

GB

Meat	Pre-heat	Temperature °C	Time (approx.)	Position in Oven
Beef/ Lamb (slow roasting)	Yes	170/180	35 mins per 450g (1lb) + 35 mins over.	Runner 1 from bottom of oven.
Beef/ Lamb (foil covered)	Yes	190/200	35-40 mins per 450g (1lb)+20mins	
Pork (slow roasting)	Yes	170/180	40 mins per 450g (1lb) + 40 mins over	
Pork (foil covered)	Yes	190/200	40 mins per 450g (1lb)+25mins	
Veal (slow roasting)	Yes	170/180	40-45 mins per 450g (1lb) + 40 mins over	
Veal (foil covered)	Yes	190/200	40-45 mins per 450g (1lb)+25mins	
Poultry/Game (slow roasting)	Yes	170/180	25-30 mins per 450g (1lb) + 25 mins over	
Poultry/Game (foil covered)	Yes	190/200	25-30 mins per 450g (1lb)+10mins	
Casserole	Yes	150	2-2 1/2 hrs	

If using aluminium foil, never:

1. Allow foil to touch sides of oven.
2. Cover oven interior with foil.
3. Cover shelves with foil.

The most accurate method of testing the readiness of joints of meat or whole poultry is to insert a meat thermometer into the thickest part of a joint, or the thickest part of poultry thighs, during the cooking period. The meat thermometer will indicate when the required internal temp has been reached.

Beef -	Rare: 60°C	Lamb: 80°C	Poultry: 90°C
	Medium: 70°C	Pork: 80°C	
	Well Done: 75°C	Veal: 75°C	

Top Oven Temperature Charts - Baking



GB

Food	Pre-heat	Temperature °C	Time in mins.	Position in Oven
Scones	Yes	210/220	10-15	Runner 2 from bottom of oven.
Small Cakes	Yes	180/190	20-25	Runner 2 from bottom of oven.
Victoria Sandwich	Yes	170/180	20-30	Runner 2 from bottom of oven.
Sponge Sandwich (fatless)	Yes	180/190	20-25	Runner 2 from bottom of oven.
Swiss Roll	Yes	200/210	10-15	Runner 2 from bottom of oven.
Semi-rich Fruit cakes	Yes	150/160	60-75 7 inch	Runner 1 from bottom of oven.
Rich Fruit cakes)	Yes	140/150	Time Dependent on size	Runner 1 from bottom of oven.
Shortcrust Pastry	Yes	190/200	Time Dependent on recipe	Runner 1 or 2 from bottom of oven.
Puff Pastry	Yes	200/210	Time Dependent on recipe	Runner 1 from bottom of oven.
Yorkshire Pudding	Yes	190/200	30-40	Runner 1 or 2 from bottom of oven.
Individual Yorkshire Puddings	Yes	200/210	20-30	Runner 2 from bottom of oven.
Milk Pudding	Yes	140/150	90-120	Runner 1 from bottom of oven.
Baked Custard	Yes	150/160	40-50	Runner 1 from bottom of oven.
Bread	Yes	200/210	30-45	Runner 1 from bottom of oven.
Meringues	Yes	100	150-180	Runner 2 from bottom of oven.

Note: If soft margarine is used for cake making, temperatures recommended by the manufacturers should be followed. Temperatures recommended in this chart refer to cakes made with block margarine only.

Main Oven - The Intelligent Cooking System

GB

The main oven of your new cooker is equipped with an intelligent electronic cooking system that gives you additional cooking performance, flexibility and features over traditional cooking products.

See cooking charts for temperatures and shelf positioning.

Cooking temperature ranges

The intelligent cooking system will automatically suggest a suitable cooking temperature for several cooking modes. It is possible however to modify the suggested temperature within a range specific to each cooking mode.

Telescopic runners and Meat pan*

The main oven on this cooker comes equipped with telescopic runners, meat pan and a food support.

The meat pan is suitable for cooking joints of meat and poultry using the intelligent cooking system (Fan, Traditional, Roast Meat and Roast Chicken).

Use the information given in the 'Cook Charts' for the shelf positioning of the pan and runners.

To reposition the telescopic runners unclip the runners from position, move them to the position you require and re-clip them to secure.

*Available only on certain models

Main Oven - The Intelligent Cooking System



GB

Cooking Advice Table

COOK CHART - Traditional mode:					COOK CHART - Fan oven mode:			
Meat	Pre-heat	Temperature	Shelf Position	Cooking Time	Meat	Pre-heat	Temperature	Cooking Time
Beef	yes	190/200°C	2 or 3	20-25 minutes per 450g (1lb) + 20 minutes extra	Beef	No	160/180°C	20-25 minutes per 450g (1lb) + 20 minutes extra
Beef (foil covered)	yes	190/200°C	2 or 3	35-45 minutes per 450g (1lb)	Beef (foil covered)	Yes	180/190°C	30-35 minutes per 450g (1lb)
Lamb	yes	190/200°C	2 or 3	25-30 minutes per 450g (1lb) + 25 minutes extra	Lamb	No	160/180°C	25 minutes per 450g (1lb) + 25 minutes extra
Lamb (foil covered)	yes	190/200°C	2 or 3	35-45 minutes per 450g (1lb)	Lamb (foil covered)	Yes	180/190°C	30-35 minutes per 450g (1lb)
Pork	yes	190/200°C	2 or 3	30-35 minutes per 450g (1lb) + 30 minutes extra	Pork	No	160/180°C	25 minutes per 450g (1lb) + 25 minutes extra
Pork (foil covered)	yes	190/200°C	2 or 3	40 minutes per 450g (1lb)	Pork (foil covered)	Yes	180/190°C	40-45 minutes per 450g (1lb)
Poultry	yes	190/200°C	2 or 3	20-25 minutes per 450g (1lb) + 20 minutes extra	Chicken/Turkey (up to 4kg/8lb)	No	160/180°C	18-20 minutes per 450g (1lb) + 20 minutes extra
Poultry (foil covered)	yes	190/200°C	2 or 3	25-30 minutes per 450g (1lb)	Chicken/Turkey (foil covered)	Yes	170/180°C	30-35 minutes per 450g (1lb)
Turkey (4-5.5kg/8-12lb)	No	150/160°C		12-14 minutes per 450g (1lb) + 15 minutes extra				
Notes: Internal Temperatures:					Notes: Internal Temperatures:			
Beef rare 60°C					Beef rare 60°C			
Beef medium 70°C					Beef medium 70°C			
Beef well done 75°C					Beef well done 75°C			
Lamb 80°C					Lamb 80°C			
Pork 80°C					Pork 80°C			
Poultry 90°C					Poultry 90°C			
BAKING					BAKING			
Preheat	Temperature			Cooking Time	Preheat	Temperature		Cooking Time
yes	200°C		2	10-15 minutes	yes	200/210°C		8-10 minutes
yes	180/190°C		2	15-25 minutes	yes	170/180°C		15-25 minutes
yes	170/180°C		2	20-30 minutes	yes	160/170°C		20-30 minutes
yes	190/200°C		3	15-20 minutes	yes	180/190°C		10-20 minutes
yes	190/200°C		2	10-15 minutes	yes	190/200°C		10-15 minutes
yes	150/160°C		2	60-75 minutes	yes	140/150°C		60-75 minutes
yes	130/140°C		2	depending on size	no	130/140°C		depending on size
yes	190/200°C		2 or 3	depending on recipe	no	190/200°C		depending on recipe
yes	190/200°C		2 or 3	depending on recipe	no	190/200°C		depending on recipe
yes	190/200°C		3	35-45 minutes	yes	180/190°C		30-45 minutes
yes	200/210°C		3	20-30 minutes	yes	190/200°C		20-25 minutes
yes	200/210°C		3	30-45 minutes	yes	200/210°C		30-45 minutes
yes	80/90°C		3	180-240 minutes	no	80/90°C		180-240 minutes
Notes: For best results use one shelf. Preheat the oven before use.					Notes: Use up to 2 shelves when cooking (ensure they are evenly spaced) it is not necessary to preheat the oven for some items.			

Cooking advice table*

Modes	Foods	Weight (in kg)	Rack position		Preheating	Recommended Temperature (°C)	Cooking duration (minutes)
			Standard guide rails	Sliding guide rails			
	Manual*						
Low temperature (Raising)*	Rising process for dough made with yeast (brioches, bread, sugar pie, croissants, etc.).		2	2	no	35-40	
	Automatic**						
Roast Meat	Roast dishes	1	2 or 3	2	no		
Fish fillets	Cod	0,4-0,5	2 or 3	2	no		
	Perch	0,4-0,5	2 or 3	2	no		
	Trout	0,4-0,5	2 or 3	2	no		
Bread***	Bread (see recipe)	1	1 or 2	1	no		
Baked cakes	Baked cakes	1	2 or 3	2	no		

* The cooking times listed above are intended as guidelines only and may be modified according to personal tastes. Oven preheating times are set as standard and may not be modified manually.

*** As stated in the recipe, pour 50 g (0,5 dl) water into the dripping pan in position 5.

** The duration of automatic cooking functions are set by default. The values can be modified by the user, starting with the default duration.

! AUTOMATIC COOKING FUNCTIONS:

When cooking/baking the foods of the weight that varies slightly from the suggested, the cooking duration can be customised according to personal taste by modifying the relevant value by $\pm 5/20$ minutes.

If using aluminium foil, never:

1. Allow foil to touch sides of oven.
2. Cover oven interior with foil.
3. Cover shelves with foil.

Temperature Conversion Chart

GB

Gas Mark	°F	Main Conventional Oven	Main Fan Oven
½	250	120	100
1	275	140	120
2	300	150	130
3	325	160	140
4	350	180	160
5	375	190	170
6	400	200	180
7	425	220	200
8	450	-	210
9	475	-	220

Warning: Before cleaning, please ensure that the electricity supply to the appliance is switched off and the appliance is fully cold.

! Never use steam cleaners or pressure cleaners on the appliance.

! Clean the glass part of the oven door using a sponge and a non-abrasive cleaning product, then dry thoroughly with a soft cloth. Do not use rough abrasive material or sharp metal scrapers as these could scratch the surface and cause the glass to crack.

! The accessories can be washed like everyday crockery (even in your dishwasher).

1. "STAYCLEAN" OVEN LINERS* (Top Oven Sides, Main Oven Sides and Rear Panel)

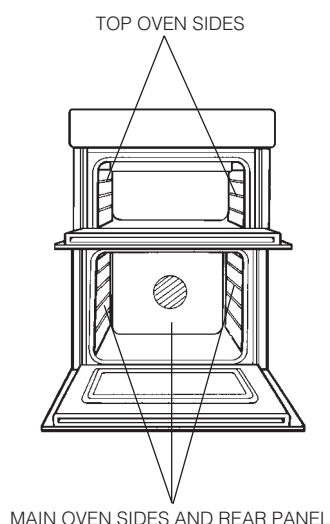

(a) How "Stayclean" works.

The surfaces of the "Stayclean" oven liners (Main Oven rear panel) are treated with a special vitreous enamel which absorbs cooking soils. At temperatures of 220°C (425°F) or above, the special surface enables these soils to be slowly destroyed. The higher the temperature the more effective it is.

(b) Cleaning.

In most cases normal cooking operations at 220°C (425°F) will permit this cleaning operation to proceed during cooking. However if higher cooking temperatures are not used regularly, it may be necessary, in order to prevent heavy soiling, to run the ovens without shelves or meat pan, at a maximum setting for a couple of hours (Fan Oven mode only).

It should not normally be necessary to clean the "Stayclean" panels with water. If the user feels it is desirable to do so, wipe them over with a clean, soapy cloth, followed by a wipe with a clean damp cloth.

DO NOT use biological washing powder, harsh abrasives or chemical oven cleaners of any kind as this could damage the "Stayclean" oven liners.

2. CLEANING GRILL, TOP OVEN AND MAIN OVEN

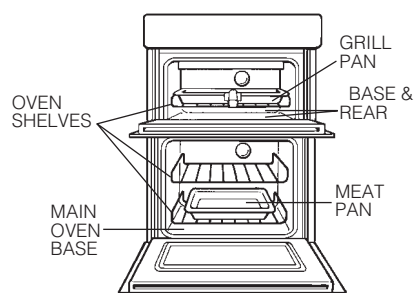

(a) Base & Rear of Top Oven and Base of Main Oven.

Wipe out the oven with a damp soapy cloth. For more stubborn stains on the base of the oven use a well soaped fine steel wool soap pad.

(b) Grill Pan, Meat Pan* & Oven Shelves.

To prevent stains from being burnt on to the grill pan, food support and rod shelf, always wash immediately after use in warm soapy water. Use a well soaped fine steel wool soap pad to remove stubborn stains from the rod shelves, grill pan, meat pan and the base of the oven.

DO NOT use aerosol cleaners on this oven as they could adversely affect the fan motor unit, and cannot be wiped off the fan blade.

(c) Solarplus Grill.

To clean the Solarplus Grill, use a clean, damp, soapy cloth and wipe over. If stubborn stains remain, gently clean with a well soaped nylon scouring pad and wipe over with a damp cloth.

DO NOT use metal cleaning utensils, wire wool or proprietary oven cleaners on the grill element mesh.

*Available only on certain models

Care and Cleaning

GB

3. OVEN DOORS

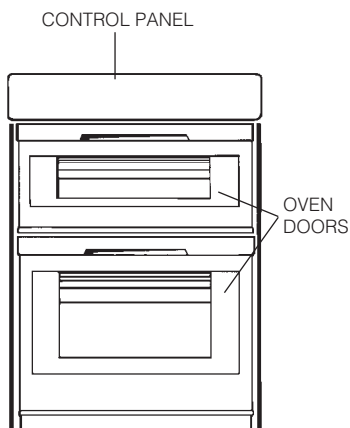

(a) Control Panel

Regularly wipe with a clean, damp cloth and polish with a clean, dry cloth.

(b) Inner Door Panels & Glass

Open the door fully. The glass panel may now be washed. Stubborn stains can be removed by using a well soaped, fine steel wool soap pad.

DO NOT use scouring pads, or abrasive powder, which will scratch the glass.

4. REPLACEMENT OF THE OVEN LAMP

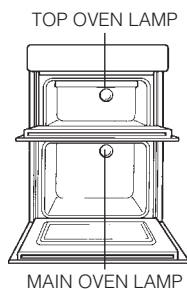

Warning: To avoid electric shocks - please ensure that the electricity supply to the appliance is switched off and the appliance is fully cold, before removing the lamp lens.

Open the oven door and remove the oven shelves. Using a thick cloth, grip the lamp lens, unscrew anticlockwise and remove the lens. Carefully unscrew the bulb anti-clockwise. Fit replacement bulb (25W 300°C SES) and refit lens.

5. HOW TO CLEAN THE LAMP LENS

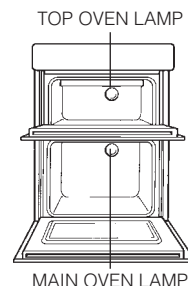

Warning: To avoid electric shocks - please ensure that the electricity supply to the appliance is switched off and the appliance is fully cold, before cleaning lamp lens.

Open the oven door and remove the oven shelves. Using a thick cloth, grip the lamp lens, unscrew anticlockwise and remove. Clean with a non-abrasive cleansing cream and refit lamp lens.

DO NOT use scouring pads, or abrasive powder, which will scratch the glass lens

CLEANING THE DOORS

Take particular care not to damage the inner surface of the door inner glass that is coated with a heat reflective layer. Do not use scouring pads, or abrasive powder, which will scratch the glass. Ensure that the glass panel is not subjected to any sharp mechanical blows.

Stubborn stains can be removed by using a fine steel wool soap pad. For slight soiling the inner glass panel may be cleaned, while still warm, without removing it from the door. After cleaning, rinse and dry with a soft cloth.

DROP DOWN DOORS

Remove the door inner glass as follows.

1. Open the door fully and remove the extrusion end caps (This should be done by hand but if it proves too difficult, simply lift the inner glass to ease the end caps out of position).

NOTE: If you need to use a tool - be careful not to damage the extrusion or end cap.

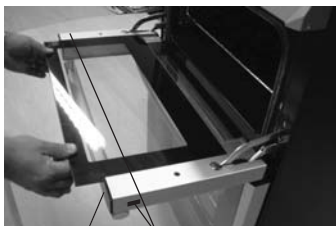

Top filler cap Remove both screws to remove top filler cap

2. Carefully slide the inner glass towards you and withdraw it from its locating slots. Ensure that the door is not allowed to slam shut, due to the reduction in door weight. Clean the glass as described above.
3. The inside of the outer door glass can now be cleaned while still fitted to the cooker.

NEVER OPERATE THE COOKER WITHOUT THE INNER DOOR GLASS IN POSITION.

Refit the door inner glass as follows.

1. Open the door fully.
2. Locate the inner door glass into its slots. The inner door glass has a special reflective coating on one side, in order to minimise surface temperatures and energy consumption during use, it is important it is fitted correctly.
3. Carefully slide the glass into its slots as far as it will go and replace the top filler cap.

GB

If something goes wrong...

GB

Before calling a Service Engineer, please check through the following lists.
THERE MAY BE NOTHING WRONG.

Problem	Check
Slight odour or small amount of smoke when grill / oven used for first time	This is normal and should cease after a short period.
Nothing works	If you find that the timer display is blank, then it is likely that there is no electricity supply to your oven. Check: (i) That the main cooker wall is switched on (ii) Other appliances, to see if you have had a power cut (iii) The main circuit breaker for the property
Top oven, grill and main oven do not work.	Operating the cooker under the following conditions may cause a safety device to operate: (a) Grilling with the door closed - Always grill with the door fully open (b) Grilling for an excessively long period at maximum setting - see Grilling guide. Switch off appliance and allow to cool for approx 30 mins. Switch the cooker back on and check that the Grill / Top oven is now operating.
Grill keeps turning on and off	When the Grill control is operating at less than its maximum setting, the Grill will cycle on and off, this is normal and <u>not</u> a fault.
Timer Display is flashing '0.00' 	The power supply to your oven has possibly been interrupted, but has now come back on again. Reset the timer to the correct time and "Manual" operation using the instructions given in the timer section of the book.
Oven temperatures too high or low	Check temperature and shelf positions are as recommended in the Oven Temperature Charts. It may be necessary to increase or decrease the recommended temperature slightly to suit your taste.
Oven does not cook evenly	Check: (a) Temperature and shelf positions are as recommended in the Oven Temperature Charts. (b) Oven utensils being used allow sufficient air flow around them.
The oven is not working and showing F01 to F68 code in the display	Your appliance has developed a fault which will require assistance from our service department.

If something goes wrong...

Problem	Check
Oven light does not work	The oven lamp is not covered by the guarantee. The part is easily changed (see the section on oven lamp replacement). A new lamp may be obtained from our Parts department see back page.
Draught from beneath control panel	A gentle flow of air will be blown from beneath the control panel when the appliance is used. If the appliance is still warm, this cooling fan may run on, or restart itself when all controls have been turned off. The fan will stop once the appliance has been cooled. This is normal and not a fault.
Steam / Condensation in the oven after use.	Steam is a by - product of cooking any food with a high water content. To help minimise always: a) Try to avoid leaving food in the oven to cool after being cooked. b) Use a covered container, wherever possible.

If you have been through the above list and there is still a problem, contact Service (see back page).

Problem	Possible cause	Solution
The "Clock button" and the digits on the display flash.	The appliance has just been connected to the electricity mains or there has been a blackout.	Set the clock.
A programmed cooking mode does not start.	There has been a blackout.	Reprogram the cooking mode.
Only the high luminosity "Clock button" is lit.	The appliance is in standby mode.	Press any button to exit standby mode.
An automatic mode has been selected. "Hot" appears on the display and cooking does not start.	The temperature inside the oven is higher than the suggested value for the selected mode.	Wait for the oven to cool down.
Fan-assisted cooking has been selected and the food looks burnt.	Positions 1 and 5: the direct heat could cause temperature-sensitive foods to burn.	We recommend switching dripping pan positions halfway through cooking.

Disposal of your product

To minimise the risk of injury to children please dispose of your product carefully and safely. Remove all doors and lids. Remove the mains cable (where fitted) by cutting off flush with the appliance and always ensure that no plug is left in a condition where it could be connected to the electricity supply. To help the environment, Local Authority instructions should be followed for the disposal of your product.

The European Directive 2002/96/EC on Waste Electrical and Electronic Equipment (WEEE), requires that old household electrical appliances must not be disposed of in the normal unsorted municipal waste stream. Old appliances must be collected separately in order to optimise the recovery and recycling of the materials they contain and reduce the impact on human health and the environment.

The crossed out "wheeled bin" symbol on the product reminds you of your obligation, that when you dispose of the appliance it must be separately collected.

Consumers should contact their local authority or retailer for information concerning the correct disposal of their old appliance.

Disposal of old electrical appliances



Guarantee

12 months Parts and Labour Guarantee

Your appliance has the benefit of our manufacturer's guarantee, which covers the cost of breakdown repairs for twelve months from the date of purchase.

This gives you the reassurance that if, within that time, your appliance is proven to be defective because of either workmanship or materials, we will, at our discretion, either repair or replace the appliance at no cost to you.

The guarantee is subject to the following conditions:

- The appliance has been installed and operated correctly and in accordance with our operating and maintenance instructions.
- The appliance is only used on the electricity or gas supply printed on the rating plate.
- The appliance has been used for normal domestic purposes only.
- The appliance has not been altered, serviced, maintained, dismantled or otherwise interfered with by any person not authorised by us.
- Any repair work must be undertaken by us or our appointed agent.
- Any parts removed during repair work or any appliance that is replaced become our property.
- The appliance is used in the United Kingdom or Republic of Ireland.

The guarantee does not cover:

- Damage resulting from transportation, improper use, neglect or interference or as a result of improper installation.
- Replacement of any consumable item or accessory. These include but are not limited to: plugs, cables, batteries, light bulbs, fluorescent tubes and starters, covers and filters.
- Replacement of any removable parts made of glass or plastic.

THE GUARANTEE WILL NOT APPLY IF THE APPLIANCE HAS BEEN USED IN COMMERCIAL OR NON-DOMESTIC PREMISES.

5 Year Parts Guarantee

Hotpoint also offers you a FREE 5 year parts guarantee. This additional guarantee is conditional on you registering your appliance with us and the parts being fitted by one of our authorised engineers. There will be a charge for our engineer's time. To activate the extra parts warranty on your appliance, simply call our registration line on **08448 24 24 24 (ROI 01 230 0800)**

Extended Guarantees

We offer a selection of protection plans that enable you to fully cover yourself against the expense of repair bills for the life of your policy. To find the ideal plan for you please call our advice line on **08448 226 226 (ROI 01 230 0233)**

Free Helpdesk Service

We have a dedicated team who can provide free advice and assistance with your appliance if you experience any technical difficulties within the first 90 days of ownership.

Simply call our Hotpoint Service Hotline on **08448 224 224 (ROI 0818 313 413)** for telephone assistance, or, where necessary, to arrange for an engineer to call.

After Sales Service

No one is better placed to care for your Hotpoint appliance during the course of its working life than us - the manufacturer.

Essential Contact Information

Hotpoint Service

We are the largest service team in the country offering you access to 400 skilled telephone advisors and 1100 fully qualified engineers on call to ensure you receive fast, reliable, local service.

UK: 08448 224 224
Republic of Ireland: 0818 313 413
www.hotpoint.co.uk

Please note: Our advisors will require the following information:

Model number

Serial number

Parts & Accessories

We supply a full range of genuine replacement parts as well as accessory products that protect and hygienically clean your appliance to keep it looking good and functioning efficiently throughout its life.

UK: 08448 225 225
Republic of Ireland: 0818 313 413
www.hotpointservice.co.uk

Appliance Registration

We want to give you additional benefits of Hotpoint ownership. To activate your FREE 5 year parts guarantee you must register your appliance with us.

UK 08448 24 24 24
Republic of Ireland: 01 230 0800
www.hotpointservice.co.uk

As part of Hotpoint's continued commitment to helping the environment, Hotpoint reserves the right to use quality, recycled components to keep down customer costs and minimise material wastage.

Indesit Company UK Limited, Morley Way, Peterborough, PE2 9JB
Indesit Company, Unit 49 Airways Industrial Estate, Dublin 17

Free Manuals Download Website

<http://myh66.com>

<http://usermanuals.us>

<http://www.somanuals.com>

<http://www.4manuals.cc>

<http://www.manual-lib.com>

<http://www.404manual.com>

<http://www.luxmanual.com>

<http://aubethermostatmanual.com>

Golf course search by state

<http://golfingnear.com>

Email search by domain

<http://emailbydomain.com>

Auto manuals search

<http://auto.somanuals.com>

TV manuals search

<http://tv.somanuals.com>