

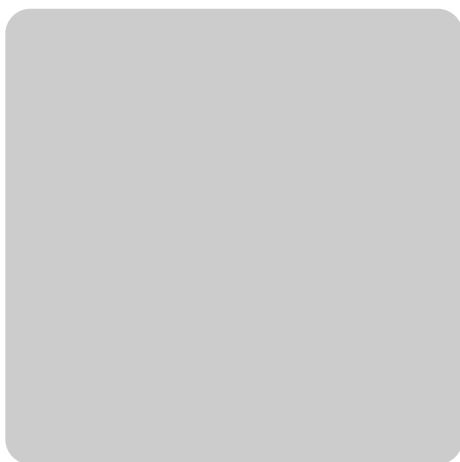

Designed for the real world

# Instructions



C262E  
C361E  
C362E  
C363E  
C366E

---

# Contents

---

Introduction	2
Installation	3
Safety Information	4
Features - C262E	6
Features - C361E, C362E, C363E & C366E	7
Control Panels	8
Clock / Minute minder (C262E, C362E & C363E)	10
Oven Timer Operation (C361E and C366E)	12
Temperature Conversion Chart	18
Sealed Hob (C262E)	19
Ceramic Hob (C361E, C362E, C363E and C366E)	21
Choosing Your Utensils	25
Grill Pan and Handle	27
Grill	28
Guide to Grilling	29
Top Oven Cookery Notes	30
Main Oven Cookery Notes	31
Oven Temperature charts	32
Using the Main Oven for Other Functions	34
Care and Cleaning	35
Cooking Results Not Satisfactory?	40
Something Wrong With Your Cooker?	41
Key Contacts	Back Cover

---

**You must read these instructions prior to using the appliance and retain them for future reference.**

---

# Introduction

---

Your new appliance is guaranteed\* and will give lasting service. This guarantee is only applicable if the appliance has been installed in accordance with the installation instructions detailed in this booklet.

To help make best use of your cooking equipment, please read this booklet carefully.

The cooker is designed specifically for domestic use and responsibility will not be accepted for use in any other installation.

**When the cooker is first used an odour may be emitted,  
this will cease after a period of use**

When first using the cooker ensure that the room is well ventilated (e.g. open a window or use an extractor fan) and that persons who may be sensitive to the odour avoid any fumes. It is suggested that any pets be removed from the room until the smell has ceased. This odour is due to temporary finish on oven liners and elements and also any moisture absorbed by the insulation.

**\* The guarantee is subject to the provisions that the appliance:**

- (a) Has been used solely in accordance with the Users Instruction Book.**
- (b) Has been properly connected to a suitable supply voltage as stated on the rating plate attached to this equipment.**
- (c) Has not been subjected to misuse or accident or been modified or repaired by any person other than the authorised employee or agent.**
- (d) Has been correctly installed.**

## Disposal of your product

To minimise the risk of injury to children please dispose of your product carefully and safely. Remove all doors and lids. Remove the mains cable (where fitted) by cutting off flush with the appliance and always ensure that no plug is left in a condition where it could be connected to the electricity supply.

To help the environment, Local Authority instructions should be followed for the disposal of you product.

This appliance conforms to the following EEC Directives:

Electromagnetic Compatibility	Low Voltage Equipment
89/336/EEC	73/23/EEC
92/31/EEC	93/68/EEC
93/68/EEC	



---

# Installation

---

**WARNING – THIS APPLIANCE MUST BE EARTHED.**

## Mains Connection

Your cooker should have been checked to ensure that the voltage corresponds with your supply voltage, this is stated on the rating plate, which is situated on the front of the plinth.

The cooker must be connected by a competent person such as one who is a, NICEIC registered contractor to a suitable double-pole control unit with a minimum rating of 32A and a minimum contact clearance of 3mm (applicable to newer properties, older properties where a 30A double pole control unit and a minimum contact clearance of 3mm is acceptable).

The double pole control unit should be fitted adjacent to the cooker, in accordance with IEE regulations. The control unit must be within 2 metres of but not directly above the appliance and should be easily accessible in the event of an emergency.

The power supply cable should conform to B.S.6004 with a conductor size of 6mm<sup>2</sup>, minimum.

Access to the mains terminals is gained by removing the rear access cover. The mains cable must pass through the cable clamp adjacent to the terminal block. Sufficient cable should be used to allow the cooker to be pulled out for servicing.

**Ensure that the mains cable is routed away from any brackets affixed to the rear panel and is not trapped to the rear wall when pushing the cooker into position between cabinets.**

## Levelling

Two rear wheels and two front feet are fitted which can be adjusted up or down to set the height (900mm - 915mm) and level the cooker.

1. The rear wheels can be raised or lowered from the BACK of the cooker by adjusting the levelling screws 'A' in the plinth.
2. The front feet can be simply screwed in or out to lower or raise the front of the cooker.

**CAUTION:** Some soft floor coverings may get damaged if the cooker is not moved carefully.

**NOTE:** Ensure oven shelves are level by using a spirit level on the rod shelves.

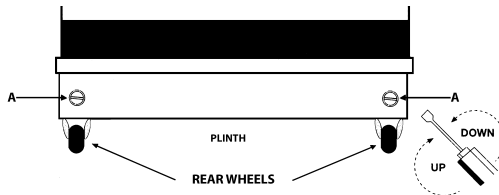

**VIEWED FROM REAR**

## Siting the Cooker

The cooker is designed to fit between kitchen cabinets spaced 600mm apart. The space either side need only be sufficient to allow withdrawal of the cooker for servicing. It can be used with cabinets one side or both as well as in an angled corner setting. It can also be used freestanding. Adjacent side walls which project above hob level, must not be nearer to the cooker than 150mm and should be protected by heat resistant material. Any overhanging surface or cooker hood should not be nearer than 650mm.

**Note: This appliance must NOT be fitted on a platform.**

## Moving the Cooker

Before moving your cooker, switch off at the cooker control unit, ensure that it is cool.

Open the grill door sufficiently to allow a comfortable grip on the underside front edge of the oven roof, avoiding any grill elements.

## Radio Interference

This appliance conforms to EN 55014 regarding suppression of radio and television interference.

**Note: Take care in moving the cooker as it is heavy. Take care to ensure that any floor covering is not damaged.**

---

# Safety Information

---

**When used properly your appliance is completely safe but as with any electrical product there are certain precautions that must be observed.  
PLEASE READ THE PRECAUTIONS BELOW BEFORE USING YOUR APPLIANCE.**

## Always

- Remove all packing from the appliance before switching on for the first time.
- Understand the controls prior to using the appliance.
- Keep children away from the appliance when cooking as the surfaces will get extremely hot during and after use.
- Turn controls **off** when not in use.
- Stand back when opening an oven door to allow any build up of steam or heat to disperse.
- Always use dry good quality oven gloves when removing items from the oven/grill.
- Always place pans centrally over the hotplate making sure handles are kept away from the edge of the hob and cannot become heated by other hotplates or pans.
- Always take care to avoid heat or steam burns when operating the controls.
- Always turn off the electricity supply at the wall switch and allow the appliance to cool before cleaning (or changing an oven lamp if fitted).
- Always make sure the shelves are in the correct position before switching on the oven or grill.
- Always keep the oven/grill door closed when the appliance is not in use.
- Always keep the appliance clean as a build up of grease or fat from cooking can cause a fire.
- Always follow the basic principles of food handling and hygiene to prevent the possibility of bacterial growth.
- Always keep ventilation slots clear of obstructions.
- Always refer servicing to a qualified appliance service engineer.
- Always take care when removing items from the grill compartment when the lower oven is in use as the contents will be hot
- Always turn off the electricity supply to the appliance at the wall switch should any glass panel (if fitted) crack or shatter and then **DO NOT USE THE APPLIANCE** until repaired.
- During use, the oven becomes hot. Care should be taken to avoid touching heating elements inside the oven.

---

# Safety Information

---

## Never

- Never stare at Halogen heating units
- Never leave children unsupervised where a cooking appliance is installed as all surfaces will be hot during and after its use.
- Never allow anyone to sit or stand on any part of the appliance.
- Never store items above the appliance that children may attempt to reach.
- Never leave anything on the hob surface when unattended and not in use.
- Never remove the oven shelves whilst the oven is hot.
- Never heat up unopened food containers as pressure can build up causing the container to burst.
- Never store chemicals/food stuffs or pressurised containers in or on the appliance, or in cabinets immediately above or next to the appliance.
- Never place flammable or plastic items on or near the hob.
- Never fill a deep fat frying pan more than 1/3 full of oil. Never use a lid.  
**DO NOT LEAVE DEEP FAT FRYING PANS UNATTENDED WHILE COOKING.**
- Never use the appliance as a room heater.
- Never use the grill to warm plates.
- Never dry any items on either the hob or oven doors.
- Never install the appliance next to curtains or other soft furnishings.
- Never operate the grill with the grill door closed as this will cause the appliance to over heat.
- Never use 'steam cleaners'.

### **SAFETY ADVICE IN CASE OF A CHIP-PAN FIRE**

In the event of a chip pan fire or any other pan fire.

1. TURN OFF THE COOKER APPLIANCE AT THE WALL SWITCH.
2. COVER THE PAN WITH A FIRE BLANKET OR DAMP CLOTH, this will smother the flames and extinguish the fire.
3. LEAVE THE PAN TO COOL FOR AT LEAST 60 MINUTES BEFORE MOVING IT. Injuries are often caused by picking up a hot pan and rushing outside with it.

**NEVER USE A FIRE EXTINGUISHER TO PUT OUT A PAN FIRE** as the force of the extinguisher is likely to tip the pan over.  
**Never use water to extinguish oil or fat fires.**

# Features Model C262E

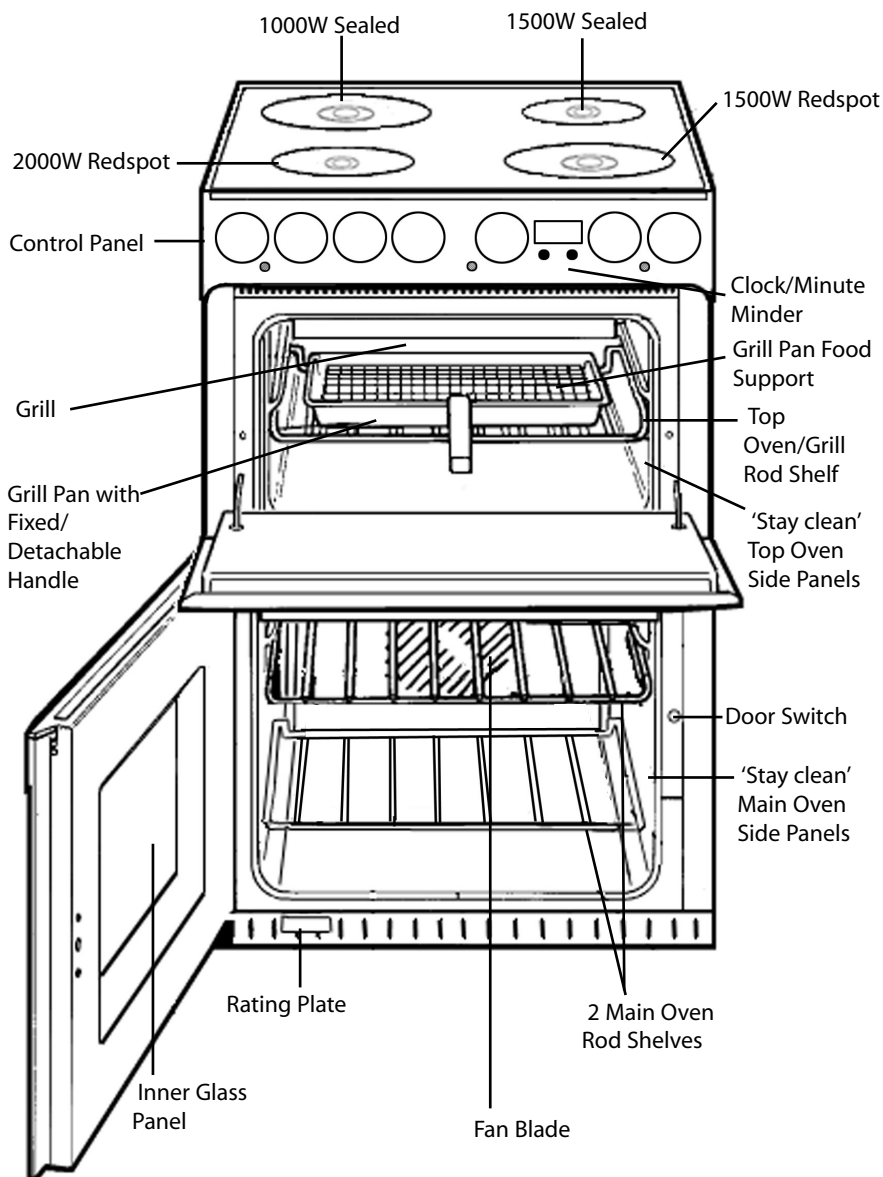

Although only 2 rod shelves are supplied in the main oven, a third shelf can be purchased from the Parts department, see back cover.

# Features – C361E, C362E, C363E and C366E

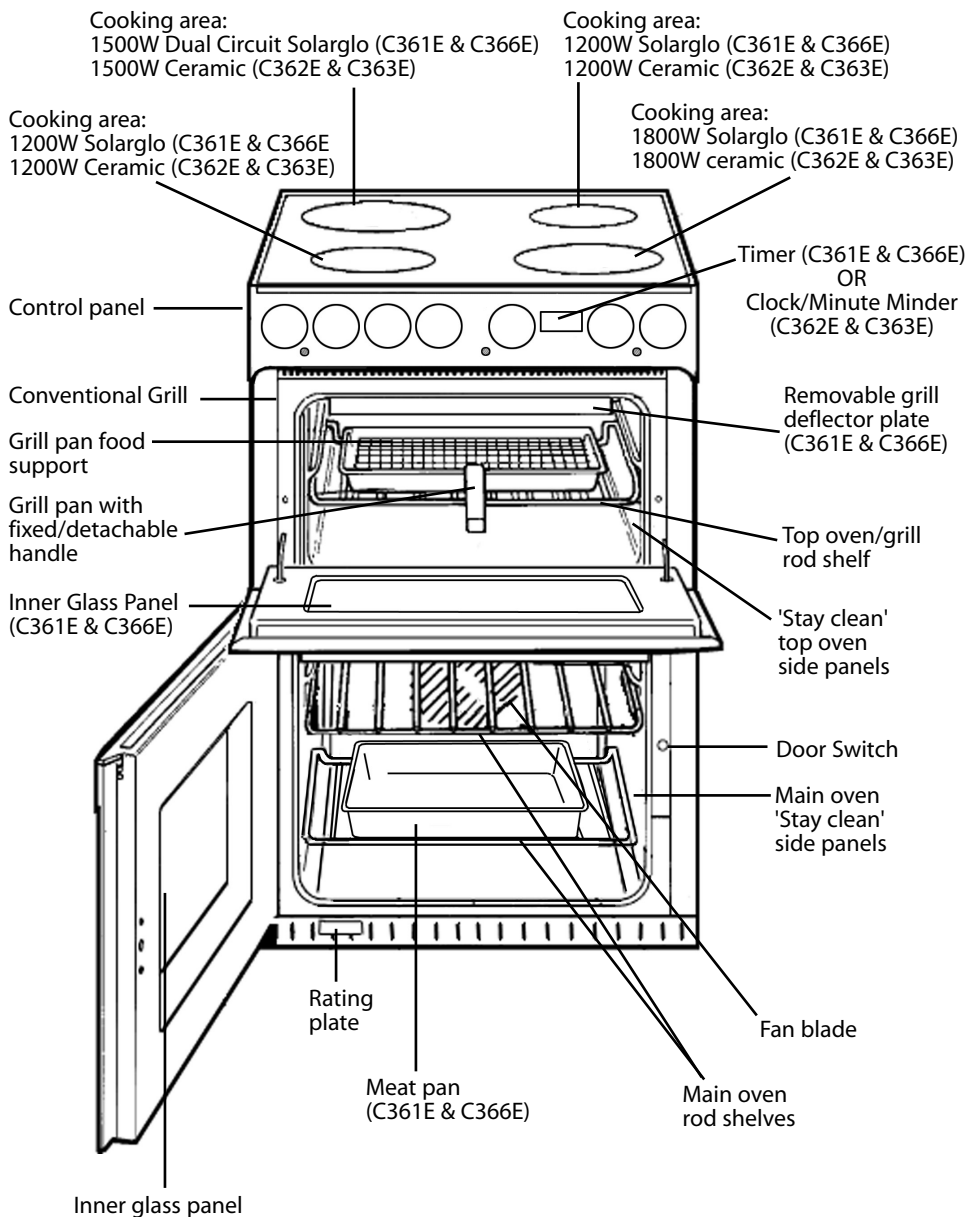

Although only 2 rod shelves are supplied in the main oven, a third shelf can be purchased from the Parts dept., see back cover.



# Control Panels

## C361E & C366E

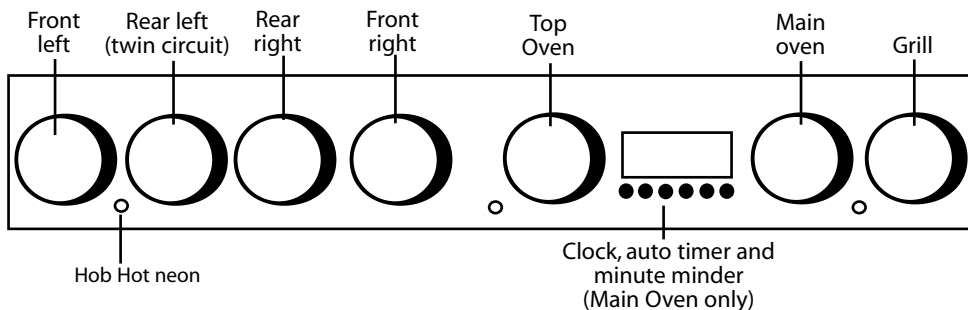

## C262E, C362E & C363E

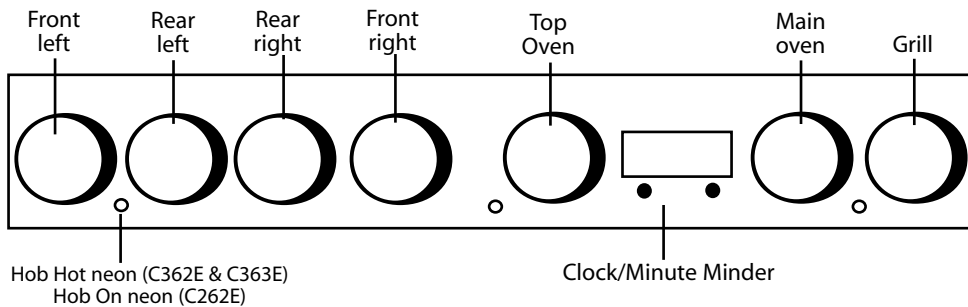

---

# Controls

---

## **Operating controls when the grill is in use**

In common with all cookers having controls sited above the grill compartment, care must be taken when setting the controls, due to the hot air expelled from the grill compartment.

Note: After use, it is advisable to check that all cooker controls have been switched **Off**.

## **Cooling fan**

A gentle flow of air will be blown below the control panel when oven/grill controls are in use.

## **Main and Top Oven lights**

The main and top oven lights will illuminate when the relevant thermostat is operated. The light will remain on during the cook period. (Note: Top Oven Light is not on all Models).

## **Slow cooking 'S'**

The main oven has an 'S' setting specially designed to reduce energy usage. Full details of this can be found in the Slow Cooking section.

## **Element and Fan cut off**

The oven is fitted with a safety device which disconnects the heating element and oven fan when the door is opened. The heating element and oven fan will not operate until the oven door is closed.

## **Hob On neon (C262E)**

Hob On neon will illuminate when any hob control is operated and will remain illuminated until all hob controls are turned off.

## **Hob Hot Neon (C361E, C362E, C363E & C366E)**

A short time (approx. 30 seconds) after the hob heating areas have been turned on, the Hob Hot neon will illuminate. This light will remain illuminated until all the hob controls have been turned off and all hob heating areas have cooled.

# Clock/Minute Minder Operation (C262E, C362E & C363E)



## CLOCKFACE

The timer incorporates a 24 hour clock.

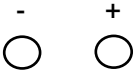

## SYMBOLS

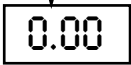

A 'Bell' symbol will light up when you select a Minute Minder Period and will remain lit for the period set.

At the end of the Minute Minder Period, the timer will emit an audible tone and the 'Bell' symbol will flash.



Minute Minder

## SETTING THE TIME OF DAY

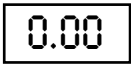

**Step 1** Make sure all oven controls are turned off.

**Step 2** Check the electricity supply to the cooker is turned on.



**Step 3** When switched on, the display will flash 0.00

**Step 4** Press and release both buttons simultaneously.

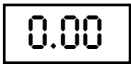

**Step 5** Press the '+' button to set the Time of Day.

The Time of Day can be adjusted, by using the '+' button to increase the time setting or the '-' button to decrease the time setting.

The Time of Day is set if no adjustments are made within 10 seconds.

**THE TIME OF DAY IS NOW SET.**

*To change the time of day repeat Steps 4 & 5 above.*

---

# Clock/Minute Minder Operation (C262E, C362E & C363E)

---

Here you can set a time period of up to 10 hours, that will count down. When it reaches zero, the timer will emit an audible tone.

**For Example:** If you set 20 minutes, the audible tone will occur 20 minutes later.

## SETTING THE MINUTE MINDER

**Step 1** Ensure the time of day is set correctly.

**Step 2** Press and release the '+' button.

**Note: Step 3 must be started within 10 seconds, otherwise you must repeat Step 2.**

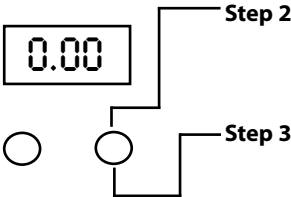

**Step 3** Press the '+' button to set the required time period. A 'Bell' symbol will light up.

The time period can be adjusted, by using the '+' button to increase the time period or the '-' button to decrease the time period.

Release all buttons, the timer display will show the remaining time period. The 'Bell' symbol will remain lit to signify that a time period has been set.



At the end of the set time an audible tone will be heard and the 'Bell' symbol will flash.



**Step 4** To cancel the audible tone press the '+' button.

To cancel the minute minder period press the '-' button until 0.00 is displayed in the window then release the button.

If at any time the display shows flashing zero's, it is likely that the electricity supply has been interrupted. Reset the timer to the correct time of day.

**Note: The Timer display will show the minute minder period as follows:**

**Any period up to 99 minutes and 50 seconds -**

The display shows MINUTES and SECONDS (10s intervals)  
eg. 19 minutes 50 seconds

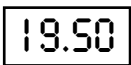

**Any period between 100 minutes (1 hour 40 minutes) and up to 10 hours -**

The display shows HOURS and MINUTES  
eg. 1 hour 41 minutes

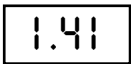

---

# Oven Timer Operation (C361E & C366E)

---

The oven timer offers you the following features:

1. Time of Day
2. Automatic Cooking
3. Minute Minder

## Automatic Cooking

The Main Oven (only) can be controlled by the automatic timer. When the timer control has been set for one oven it is possible to use the other oven manually.

## Hints on Automatic Cooking

1. Select foods which will take the same time to cook and require approximately the same temperature.
2. Set the oven timer so that the food has just finished or about to finish cooking on your return to the oven. This will ensure the food has not cooled down and does not require reheating before serving.
3. Food should be as cold as possible when it goes into the oven, ideally straight from the refrigerator. Frozen meat and poultry should be thawed thoroughly before it is put in the oven.
4. We advise that warm food should never be placed in the oven if there is to be a delay period. Stews prepared by frying the meat and vegetables should be cooked as soon as possible.
5. We advise dishes containing left-over cooked poultry or meat, for example Shepherds Pie, should not be cooked automatically if there is to be a delay period.
6. Stews and joints should be cooked by the long slow method, so that the delay period is kept to a minimum.
7. On warm days, to prevent harmful bacterial growth in certain foods (ie poultry, joints, etc) the delayed start should be kept to a minimum.
8. Wine or beer may ferment and cream may curdle during the delay period, so it is best to add these ingredients just before serving.
9. Foods which discolour should be protected by coating in fat or tossing in water to which lemon juice has been added, prior to placing food in the oven.
10. Dishes containing liquid should not be filled too full to prevent boiling over.
11. Food should be well sealed (but not airtight) in a container to prevent the loss of liquid during cooking. Aluminium foil gives a good seal.
12. Ensure food is cooked thoroughly before serving.

## Timer Operation

1. Make sure all oven controls are turned **Off**.
2. Check that the electricity supply to the oven is turned **On**.
3. Check that the oven clock is at the right time of day.

# Know your Timer (C361E & C366E)

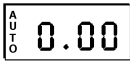

## CLOCKFACE

The timer incorporates a 24 hour clock.

**Ensure the correct time of day is always set, before using your cooker.**

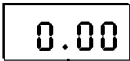

## SYMBOLS

A 'bell' symbol will light up when you select a Minute Minder Period and will remain lit for the period set.

At the end of the Minute Minder Period, the timer will emit an audible tone and the 'bell' symbol will flash.

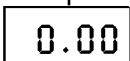

The 'cookpot' symbol will light up either:-

- When the timer is in manual mode, or
- During the actual Cook Period.

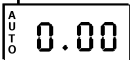

'AUTO' will light up:-

- When the timer is first turned on it will flash. It will go out when a time of day is set or when the timer is set to manual.

The 'AUTO' symbol will flash at the end of an Auto Cooking programme to indicate that the programme has finished.

**(When the 'AUTO' symbol is flashing, to return the oven to Manual operation, turn the oven controls off, ensure that the correct time of day is set, and press the "Manual" button - The 'AUTO' symbol will go out.)**



## TIMER FUNCTION BUTTONS



### Minute Minder Button

Here you can set a time period of up to 23 hours 59 minutes, that will count down. When it reaches zero, the timer will emit an audible tone.

**For Example:** If you set 20 minutes, the audible tone will occur 20 minutes later.

## AUTO COOKING PROGRAMME



### Cook Period Button

Cook Period is the actual length of time for which, the timer will switch the oven(s) on as part of an "Auto Cooking" programme.

(e.g. If you set 2 hours, the food will be cooked for 2 hours).



### End Time Button

The time of day at which you want an "Auto Cooking" programme to **end**.

**For Example:** If you set a "Cook Period" for 2 hours, and "End Time" of 11:00. The timer will switch the oven(s) on at 9:00 and turn the oven(s) off at 11:00. You will hear a audible tone at 11:00, to indicate that the Auto Cooking Programme has finished.

### Notes:

- When setting an Auto Cooking programme you will need to set the oven control(s) to the required temperature(s) when you set the timer.
- If an Auto Cooking programme has been set the oven(s) will only operate during the pre-programmed time.



### Manual Button

Needs to be pressed to cancel an Auto Cooking programme and return the oven(s) to Manual operation.

### "+" and "-" Buttons

Used to adjust the various timer function settings.

# Electronic Clock & Automatic Oven Timer

## Operation (C361E & C366E)

### SETTING THE TIME OF DAY

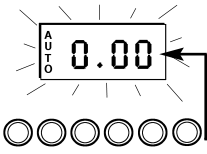

**Step 1** Make sure all oven controls are turned Off.

**Step 2** Check the electricity supply to the cooker is turned on.

**Step 3** When switched on the display will show 0.00 and the Auto symbol, flashing intermittently.

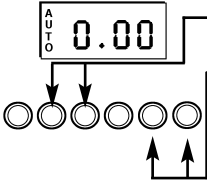

**Step 4** Press & hold in both the Cook Period & End Time buttons together.

**Step 5** With the Cook Period & End Time buttons still held in, press either the "+" or "-" buttons to set the correct time of day.

**Step 6** Release all the buttons simultaneously.

**THE TIME OF DAY IS NOW SET.**

*To change the time of day repeat Steps 4, 5 & 6 above.*

**Note:** You cannot adjust the time of day if the timer has been set for an Auto Cooking Programme.

### SETTING THE MINUTE MINDER

**Step 1** Ensure the time of day is set correctly.

**Step 2** Press and hold the Minute Minder button.

**Step 3** With the Minute Minder button held in, set the required Minute Minder period using the "+" and "-" buttons. A 'bell' symbol will light up.

Release all buttons and the timer display will revert back to the time of day. The 'bell' symbol will remain lit to signify that a Minute Minder period has been set.

At the end of the set time an audible tone will be heard, and the 'bell' symbol will flash.

**Step 4** To cancel the audible tone press the Minute Minder button.

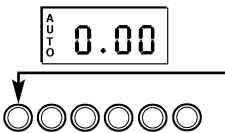
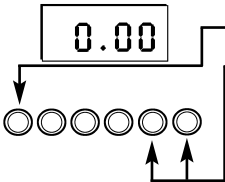

**Note 1** When the Minute Minder has been set, the time remaining can be checked at any time by simply pressing the Minute Minder button.

**Note 2** If necessary the Minute Minder can be cancelled before the tone sounds by pressing and holding the Minute Minder button and then at the same time pressing the "-" button until 0.00 appears in the display window.

# Electronic Clock & Automatic Oven Timer

## Operation (C361E & C366E)

### AUTO COOKING PROGRAMMES

There are two Auto Cooking programmes that can be selected using your timer:-

- (a) To set the timer to switch the oven(s) On and Off Automatically
- (b) To set timer to switch on immediately and OFF automatically after a set cook period.

#### a) TO SET THE TIMER TO SWITCH THE OVEN(S) ON AND OFF AUTOMATICALLY

*This allows you to cook at a specified time for a chosen period before the oven switches off Automatically.*

- Step 1** Check that the correct time of day is set, if not follow instructions for setting the time of day.
- Step 2** Place food onto the correct shelf position in the oven and close the oven door(s).

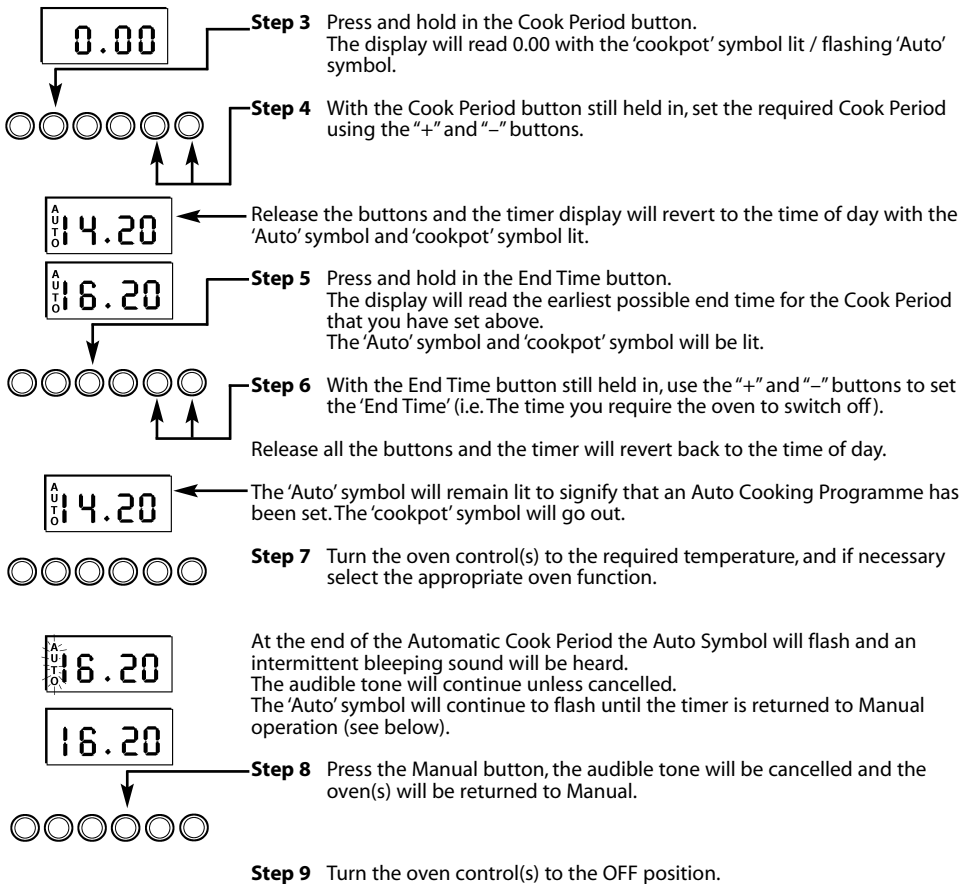



# Electronic Clock & Automatic Oven Timer

## Operation (C361E & C366E)

**Note 1** When cooking automatically the Cook Period can be checked at any time by simply pressing the Cook Period button.

**Note 2** When cooking automatically the End Time can be checked at any time by simply pressing the End Time button.

### b) TO SET TIMER TO SWITCH ON IMMEDIATELY AND OFF AUTOMATICALLY AFTER A SET COOK PERIOD

- Step 1** Check that the correct time of day is set, if not follow instructions for setting the time of day.  
**Step 2** Place food onto the correct shelf position in the oven and close the oven door(s).  
**Step 3** Turn the oven control(s) to the required temperature, and if necessary select the appropriate oven function.

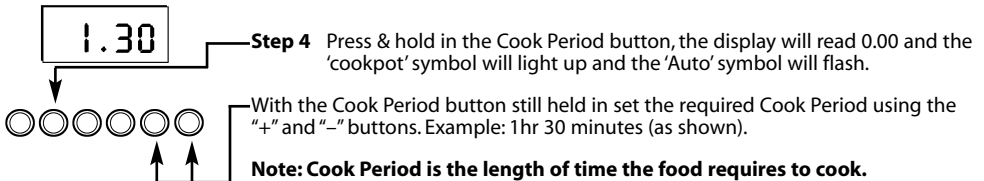

**Step 5** Release all buttons.

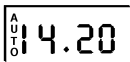

The timer display will revert to the time of day with the 'Auto' symbol lit & 'cookpot' symbol remaining lit.

NOTE: The Cookpot symbol disappears

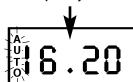

At the end of the Cook Period the 'Auto' symbol will flash and an intermittent audible tone will be heard. The audible tone will continue until cancelled. The 'Auto' symbol will continue to flash until the timer is returned to Manual operation (see below).

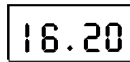

**Step 6** Press the Manual button. The audible tone will be cancelled and the oven(s) will be returned to Manual.



**Step 7** Turn the oven control(s) to the OFF position.

# Electronic Clock & Automatic Oven Timer

## Operation (C361E & C366E)

### TO CANCEL AN AUTO COOKING PROGRAMME BEFORE THE COOK PERIOD HAS FINISHED.

**Step 1** Turn the oven control(s) to the OFF position.

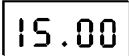

15.00

**Step 2** Press the Manual button to return the oven(s) to "Manual" operation. The 'Auto' symbol will go out.



**Note 1** When cooking automatically the Cook Period can be checked at any time by simply pressing the Cook Period button.

### OTHER NOTES ON TIMER OPERATION

1. When cooking Automatically the Cook Period can be checked at any time simply by pressing the Cook Period button.
2. When cooking Automatically the End Time can be checked at any time by simply pressing the End Time button.
3. Having set a Cook Period and End Time an electronic device stores the information. The device within the timer will switch the oven(s) on and off at the required times.
4. When setting an Auto Cooking Programme and a mistake is made, to clear:-
  - (a) Press & release the Manual button.
  - (b) Start the sequence again.
5. If at any time the display shows three flashing zero's 0.00 and 'Auto', it is likely that the electricity supply to the oven has been interrupted. Reset the timer to the correct time of day.  
**Food in the oven may, therefore, not have been cooked, before serving check food is thoroughly heated and completely cooked.**
6. To set each function always press and hold the required function button and at the same time press "+" or "-" buttons.

---

## Temperature Conversion Chart

---

<b>Gas Mark</b>	<b>°F</b>	<b>Main Conventional Oven</b>	<b>Top Convection Oven</b>	<b>Main Fan Oven</b>
1/2	250	120	110	100
1	275	140	130	120
2	300	150	140	130
3	325	160	150	140
4	350	180	170	160
5	375	190	180	170
6	400	200	190	180
7	425	220	210	200
8	450	–	220	210
9	475	–	–	220

---

# Sealed Hob General Information (C262E)

---

## USE OF HOTPLATES

**Under no circumstances should the hob be used with aluminium foil in contact with the hob surface.**

Turn the control to 6 for fast cooking. To cook more slowly or simmer, turn the control to a lower setting according to the size of the saucepan and the amount of liquid. The two small Hotplates are specially for smaller pans, low temperature cooking and simmering.

**Do Not** leave a hotplate switched on without a pan as this wastes energy and may shorten the life of the hotplate.

## CONTROL SETTINGS GUIDE

This is provided only as a guide – settings also depend on the type of pan used and the quality of food.

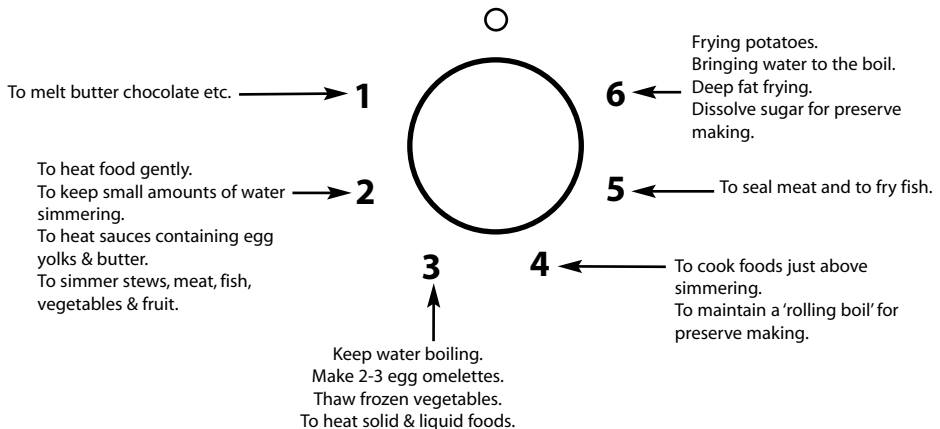

## SAFETY REQUIREMENTS FOR DEEP FAT FRYING

1. Use a deep pan, large enough to completely cover the appropriate heating area.
2. Never fill the pan more than one-third full of oil.
3. Never leave oil or fat unattended during the heating or cooking period.
4. Never try to fry too much food at a time, especially frozen food. This only lowers the temperature of the oil or fat too much, resulting in greasy food.
5. Always dry food thoroughly before frying, and lower it slowly into the hot oil or fat. Frozen foods, in particular, will cause frothing and spitting, if added too quickly.
6. Never heat fat, or fry, with a lid on the pan.
7. Keep the outside of the pan clean and free from streaks of oil or fat.

# Sealed Hob General Information (C262E)

## CHOICE OF UTENSILS

Every Electric Hob deserves the right choice of utensils. We recommend for optimum performance the use of good quality utensils.

**PANS SHOULD NOT**



Be concave  
(bowed in)



Be convex  
(bowed out)



Be rimmed



Be deeply ridged



**But essentially Flat**

Always ✓	Never ✗
<ul style="list-style-type: none"> <li>● Use good quality flat-based cookware on all electric heat sources.</li> <li>● Ensure pans have clean, dry bases before use.</li> <li>● Ensure pans match size of heating area.</li> <li>● Remember good quality pans retain heat well, so generally only a low or medium heat is necessary.</li> <li>● Ensure pan handles are positioned safely and away from heat sources.</li> <li>● Lift pans, do not drag.</li> <li>● Use pan lids except when frying.</li> <li>● Deal with spillage immediately but with care.</li> </ul>	<ul style="list-style-type: none"> <li>● Use gauze, metal pan diffusers, asbestos mats and stands e.g. Wok stands – they can cause overheating.</li> <li>● Use utensils with skirts or rims e.g. buckets and some kettles.</li> <li>● Use badly dented or distorted pans.</li> <li>● Leave an element switched on when not cooking.</li> <li>● Cook food directly on the hotplate.</li> <li>● Drag or slide utensils across the hob surface.</li> <li>● Place large preserving pans or fish kettles across two hotplates.</li> <li>● Place plastic vessels or utensils on a hot hob.</li> <li>● Use the hob as an area for storage</li> </ul>



**Always place pans centrally on the hotplate**



---

## Ceramic Hob (C362E and C363E)

---

**CAUTION: IF ANY CRACK IN SURFACE BECOMES VISIBLE, TURN OFF THE MAINS COOKER SWITCH.**

Under no circumstances should the hob be used with aluminium foil in contact with the hob surface. The following boiling plates are located beneath the circular cooking areas:-

	C362E / C363E
Front Right	6 Heat 1800W
Rear Left	6 Heat 1500W
Rear Right	6 Heat 1200W
Front Left	6 Heat 1200W

The cooking areas change colour when heated (become red) indicating which heating element is turned on. The cooking area returns to its original colour when the heating element is switched **OFF and cools**.

### Hotplates

When the control is turned from the **0** position, the settings on the control panel will show **1 - 6**, these are 6 fixed positions for cooking.

**6** is the highest setting, for fast cooking. To reduce the heat to cook more slowly or simmer, turn the knob to a lower setting which will vary according to size and type of saucepan, the amount and type of food, and whether or not the lid is fitted. Pans can be placed on the unheated areas of the panel when cooking is finished and before serving food.

It is inadvisable at any time to leave a heating element switched on without a pan in position as this wastes energy, and could make soil or rub-off from aluminium pans more difficult to remove. To protect elements against overheating, safety cut-outs have been incorporated with each element. After several minutes with the control at setting **6** the safety cut-out switches the element **Off** and **On** continuously, thus preventing any adverse effects that may be caused by an excessive build-up of heat in the cooking area.

Setting **1** provides low input for simmering. The control will be **Off** when the control knob is turned to the **0** position.

If the hob should become cracked, **never use until repaired**. Always ensure that saucepan handles are positioned safely.

---

# Ceramic Hob (C361E and C366E)

---

**CAUTION: IF ANY CRACK IN SURFACE BECOMES VISIBLE, TURN OFF THE MAINS COOKER SWITCH.**

Under no circumstances should the hob be used with aluminium foil in contact with the hob surface. The following boiling plates are located beneath the circular cooking areas:-

	C361E / C366E / C462E
Front Right	Single circuit 1800W Solarglo
Rear Left	Twin circuit 1500W Solarglo single (inner) circuit 850W
Rear Right	Single circuit 1200W Solarglo
Front Left	Single circuit 1200W Solarglo

.The cooking areas change colour when heated (become red) indicating which heating element is turned on. The cooking area returns to its original colour when the heating element is switched **OFF and cools**.

## Rear left twin circuit plate

This is a dual purpose plate with two elements. The settings on the glass control panel will show **1 - 4** when the control is turned clockwise to indicate that the whole hotplate is turned on and can be used for larger pan **4** is the highest setting. With the control knob turned anti-clockwise the settings on the glass control panel will show **1 - 4** to indicate that only the inner part of the hotplate is switched on. This is an energy saving feature and is useful for cooking with smaller pans or for slow simmering. The control will be **OFF** when the control knob is turned to the **0** position.

## Front left – Front right – Rear right –plates

When the control is turned from the **0** position, the settings on the glass control panel will show **1 - 6**.

**6** is the highest setting, for fast cooking. To reduce the heat to cook more slowly or simmer, turn the knob to a lower setting which will vary according to size and type of saucepan, the amount and type of food, and whether or not the lid is fitted. Pans can be placed on the unheated areas of the panel when cooking is finished and before serving food.

It is inadvisable at any time to leave a heating element switched on without a pan in position as this wastes energy, and could make soil or rub-off from aluminium pans more difficult to remove. To protect elements against overheating, safety cut-outs have been incorporated with each element. After several minutes with the control at setting **6** (setting **4** on twin circuit plate) the safety cut-out switches the element **Off** and **On** continuously, thus preventing any adverse effects that may be caused by an excessive build-up of heat in the cooking area.

Setting **1** provides very low inputs of 3% to 10% for low simmering. (Excluding the twin circuit plate). The control will be **Off** when the control knob is turned to the **0** position.

If hob should become cracked, **never use until repaired**. Always ensure that saucepan handles are positioned safely.

# Ceramic Hob General Information (C361E, C362E, C363E and C366E)

PANS SHOULD BE:



Not concave (bowed in)



Not convex (bowed out)



Not rimmed



Not deeply ridged



But essentially Flat

Always ✓	Never X
<ul style="list-style-type: none"> <li>● Use good quality flat-based cookware on all electric heat sources.</li> <li>● Always ensure pans have clean, dry bases before use.</li> <li>● Ensure pans match size of heating area.</li> <li>● Remember good quality pans retain heat well, so generally only a low or medium heat is necessary.</li> <li>● Ensure pan handles are positioned safely and away from heat sources.</li> <li>● Always lift pans, do not drag.</li> <li>● Always use pan lids except when frying.</li> <li>● Deal with spillage immediately but with care.</li> </ul>	<ul style="list-style-type: none"> <li>● <b>NEVER</b> Use gauze, metal pan diffusers, asbestos mats and stands e.g. Wok stands – they can cause overheating.</li> <li>● <b>NEVER</b> Use utensils with skirts or rims e.g. buckets and some kettles.</li> <li>● <b>NEVER</b> Use badly dented or distorted pans.</li> <li>● <b>NEVER</b> Leave an element switched on when not cooking.</li> <li>● <b>NEVER</b> Cook food directly on a heat source.</li> <li>● <b>NEVER</b> Drag or slide utensils, along the hob surface.</li> <li>● <b>NEVER</b> Stare at Halogen heating units.</li> </ul>

## THE BEST COMBINATIONS

This table is a general guide to the types of pan suitable for different types of hobs and cookers. Remember pans should be good quality, with smooth, flat bases. For any further information refer to manufacturers' instructions.

	Ceramic	Halogen
Aluminium	✓	✓
Stainless steel with single layer copper base	X	X
Stainless steel with sandwich bases of aluminium and stainless steel or aluminium and copper.	✓	✓
Enamelled steel	✓	✓
Enamelled aluminium	✓	✓
Enamelled based cast iron	✓ With Extra Care ✓	
Copper	X	X
Toughened glass or ceramic/ glass/pottery	Not Recommended	



# Ceramic Hob General Information (C361E, C362E, C363E and C366E)

## Do Not

- Do not** cook directly on the hob surface without a cooking utensil, as this will result in damage to the surface of the hob.
- Do not** use the hob as a worktop surface as damage may occur to the smooth surface of the hob.
- Do not** drag or slide utensils on the hob surface, as this will cause scratches in the surface of the hob.
- Do not** allow a cooking utensil to come into contact with the hob surround.
- Do not** place anything between the base of the utensil and the ceramic hob, e.g. do not use asbestos mats, aluminium or wok stand. 
- Do not** leave any utensils, food or combustible items on the hob when it is not in use.
- Do not** place aluminium or plastic foil, or plastic containers on the hob.
- Do not** leave the hotplates or cooking areas switched **On** unless they are being used.

We recommend not to place large preserving pans or fish kettles across two heating areas.

- Do not** leave utensils partly covering the heated areas. Always ensure that they are placed centrally over the heated areas and have the same diameter as the heating area used. 

We recommend not to use a utensil with a base diameter greater than 25cm (10ins).

Pressure cookers or other large pans should be used on the front cooking areas.

Always ensure that saucepan handles are positioned safely.

**IMPORTANT** – As with any cooking appliance there could be some fire risk attached to the heating of oil, particularly for deep fat frying, cooking utensils containing oil **must not be left unattended** (e.g. to answer the telephone) on or in close proximity to the patterned cooking areas.

In the unfortunate event of a chip pan fire:

1. Switch **Off** the electricity supply.
  2. Smother flames with a fire blanket or damp cloth.
- Burns and injuries are caused almost invariably by picking up the burning pan and rushing outside with it.

## Safety requirements for deep fat frying

1. Use a deep pan, large enough to completely cover the appropriate heating area.
2. Never fill the pan more than one-third full of fat or oil.
3. Never leave oil or fat unattended during the heating or cooking period.
4. Do not try to fry too much food at a time, especially frozen food. This only lowers the temperature of the oil or fat too much, resulting in greasy food.
5. Always dry food thoroughly before frying, and lower it slowly into the hot oil or fat. Frozen foods, in particular, will cause frothing and spitting, if added too quickly.
6. Never heat fat, or fry, with a lid on the pan.
7. Keep the outside of the pan clean and free from streaks of oil or fat.

---

# Choosing Your Utensils

---

## Choosing your utensils

Below are some guidelines to help you make the right choice of utensils.

To obtain a satisfactory performance from a ceramic hob and to avoid unnecessary damage, we recommend the use of good quality utensils with smooth flat bases.

## Remember

1. Purchasing a new pan will not necessarily mean it will have a flat base, always check before buying. See diagram below.
2. Using the correct pans and utensils will result in maximum contact with the hob and maximum efficiency as with any type of electric hob.

## Do Use

**Do use** good quality smooth flat based utensils.

**Do use** a utensil which has approximately the same base area as the heating area zone being used.

**Do use** utensils which have more than sufficient capacity for the amount of food being cooked to prevent boil over or spillage.

**Do use** utensils with good fitting lids.

**Do use** a low dome pressure cooker for best results.

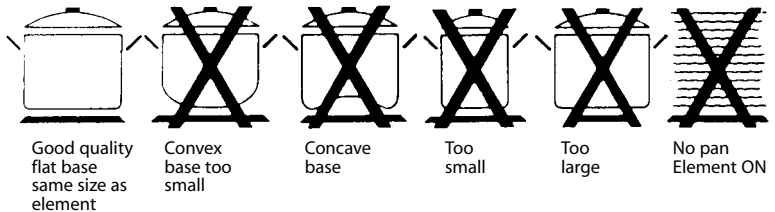

**WARNING: Extreme caution should be used when cleaning the hot hob.**

## Important

1. Always clean up any spillage immediately with a clean cloth or a paper towel to avoid unnecessary damage to the hob.  
Extreme care should be taken to avoid steam burns and hot surfaces when cleaning spillage from the hob.
2. When cooking food which contains sugar (most food) or syrup, use a utensil which is large enough to prevent boil over or spillage. **Sugar spillage will permanently damage the hob and therefore should be cleaned off with care immediately.** Taking care remove when still hot with a razor-blade scraper. This will avoid any damage. **NEVER LET IT COOL BEFORE REMOVING.**
3. Always ensure that the base of the utensil is dry before placing on the ceramic hob.

---

# Choosing Your Utensils

---

## Do Not

**Do not** use utensils with rough bases.

**Do not** use lightweight utensils with thin, distorted or uneven bases.

**Do not** use lightweight enamelled steel utensils.

**Do not** use cast iron utensils.

**Do not** use utensils with recessed, scrolled (like a gramophone record) or ridged bases.

**Do not** use a utensil which has a base concavity greater than 1mm as this will reduce the performance of the hob.

**Do not** use a utensil with a convex base.

**Do not** use glass ceramic utensils.

**Do not** use use lightweight saucepans with plain thin copper bases on ceramic or halogen hotplates.

**Note:** All copper pans are excellent conductors of heat, and are hard wearing and strong, but need quite a lot of care. They can be very heavy and do not usually have completely flat bases. The interiors are usually lined with a different material such as tin.

A stainless steel pan with a sandwich base of aluminium and stainless steel is an excellent conductor of heat and is suitable for use on ceramic and halogen hobs, providing they are used in accordance with the saucepans manufacturers' recommendations.

Stainless steel pans with a sandwich base of aluminium and copper are excellent conductors of heat. If using stainless steel saucepans with aluminium and copper sandwich bases on ceramic and halogen hobs, the use of these pans must be in accordance with the saucepan manufacturers' recommendations. Extra care should be taken to ensure the base of the pan and the hob is cleaned, and the hob conditioned, after each and every use, when using this type of saucepan.

If these recommendations are not followed, the result will be a build up of small copper deposits on the surface of your hob which, if not cleaned after each use, will result in permanent marking of your hob.

Always lift the pan from the hob, **do not** drag or slide across the hob surface as damage may occur.

---

# Grill Pan and Handle

---

## Grill pan handle

The grill pan handle is detachable from the pan, to facilitate cleaning and storage.

The handle can be either detachable from or fixed to the pan.

For a fixed handle remove the screw and washers from the grill pan bracket, tilt the handle over the recess adjacent to the bracket (A), slide it towards the centre of the pan (B) and let the handle locate over the bracket (C). Replace screw and washers and ensure that they are fully tightened up. For a detachable handle remove screw and washers from the grill pan and keep safe.

Please note that if a fixed handle is required, the grill pan cannot be kept in the Fan Oven with the door closed but may be stored in the Top Oven when the appliance is not in use.

**Warning: Ensure when using grill pan handle in the detachable manner it is centralised and secure.**

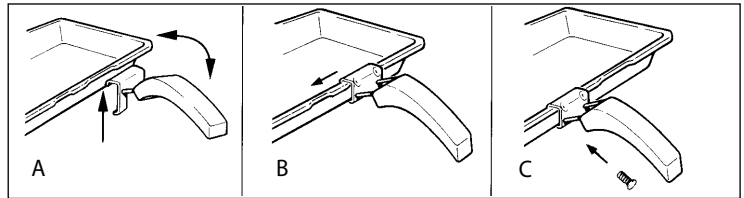

# Grill (C262E, C361E, C362E, C363E and C366E)

## Setting the Grill



**CAUTION - ACCESSIBLE PARTS MAY BECOME HOT WHEN THE GRILL IS IN USE. CHILDREN SHOULD BE KEPT AWAY.**

**GRILLING SHOULD NEVER BE UNDERTAKEN WITH THE GRILL/TOP OVEN DOOR CLOSED.**

The grill control is designed to provide variable heat control of either the twin grill elements on together or the single left hand grill element only, depending upon which direction the control knob is rotated. With the control rotated clockwise **1** through to **4** the twin elements will come on together. With the control turned anti-clockwise **1** through to **4** and the single left hand element will come on only.

The control is **Off** at **O**.

**Note: The grill will not operate unless the top oven control is in the OFF position.**

Food which requires browning only should be placed under the hot grill, directly on the shelf in the first or second runner from the bottom of the oven, according to the depth of the dish.

Open the Grill door to the grilling position. i.e. fully.

With the grill door in the grilling position, heating the grill is achieved by turning the control clockwise to the desired 'grill setting' on the control panel.

**Never:** line the grill pan with aluminium foil.

**Note:** Preheat the grill at setting **4** for approximately **5** minutes.

The grill pan is placed on the shelf or grill pan support and should be correctly positioned under the grill element. Leave the control at **4** for toast, sealing and fast cooking of foods. For thicker foods requiring longer cooking, turn the switch to a lower setting after the initial sealing on both sides at **4**. The thicker the food the lower the control should be set.

# Guide To Grilling (C262E, C361E, C362E, C363E and C366E)

Pre - heat the grill for 5 minutes on maximum control setting before grilling

## GRILL CHART

Food	Grill Setting	Approximate Cooking time
Toasting of Bread products	4	3 - 10 mins.
Small cuts of meat, sausages, bacon, etc.	4 for 4 mins. reduce to lower setting.	10 - 20 mins.
Chops etc. Gammon steaks Chicken pieces	4 for 6-8 mins. reduce to lower setting.	20 - 30 mins. Wire food support used in upturned position for chicken.
Fish: fingers Whole Filletts	4	10 - 20 mins. Whole fish and fillets placed in the base of the grill pan.
Fish in breadcrumbs	3	15 - 20 mins.
Pre - Cooked potato products	3	15 - 20 mins.
Pizzas	3	12 - 15 mins. in the base of the grill pan.
Browning of food	4	8 - 10 mins. Dish placed directly on base of the grill pan and pan placed on the base of the grill compartment.

The settings in the above guide have been developed to cook food successfully without excessive fat spitting and splashing.

---

# Top Oven Cookery Notes

---

The top oven should be used to cook small quantities of food. The oven is designed so that the grill element operates at a reduced heat output, this is combined with a heating element situated underneath the floor of the oven.

To ensure even cooking of the food it is important that cooking utensils are positioned correctly on the oven shelf so that the element is directly above.

There are two cooking positions, the shelf placed on runner 1 or 2 (from the base), do not use shelves upside down.

**Food/utensils must not be placed directly on the oven floor.**

There should always be at least 25mm (1in) between the top of the food and the grill element.

**Warning:** Items stored in top oven will get hot when main oven is in use.

## Operation

To heat the oven, turn the control knob clockwise. The top oven pilot light will come on and remain on until the oven reaches the required temperature. The pilot light will automatically go on and off during cooking as the thermostat maintains the correct temperature.

## Cooking meat/poultry

Small joints of meat up to 1.5kg (3 lbs), or poultry, up to 3.6kg (8 lbs) (60cm cookers) in weight can be roasted in a small meat pan in the top oven. Larger joints of meat/poultry weighing more than 3.6kg (8 lbs) (60cm cookers) should be roasted in the main oven.

**Do not use the main oven meat pan (not all models) or grill pan as a meat pan in the top oven as air circulation will be seriously restricted.**

## Top oven as a warming compartment for plates

Place the plates/dishes on the shelf, positioned on runner 1, turn top oven control to 100°C for 10-15 minutes. Never use grill control.

---

# Main Oven Cookery Notes

---

The oven is fitted with 'Stay clean' liners, two rod shelves and a meat pan (not all models). Remove the meat pan if it is not being used.

To heat the oven turn the knob clockwise, selecting the required temperature between 80°C (176°F) and 230°C (450°F) as recommended in the temperature chart. The pilot light will immediately come on and remain on until the oven reaches the required temperature. This light will then automatically go off and on during cooking as the oven thermostat maintains the correct temperature.

It should be noted that at the end of the cooking period there may be a momentary puff of steam when the oven door is opened. This will disperse in a few seconds and is a perfectly normal characteristic of an oven with a good door seal.

Since a circulaire fan oven heats up more quickly, and generally cooks food at a lower temperature than a conventional oven, pre-heating is often unnecessary. However, foods such as bread, scones, Yorkshire pudding, do benefit from being placed in a pre-heated oven.

The 'oven temperature charts' are a guide only, giving approximate cooking temperatures and times. To suit personal taste and requirements, it may be necessary to increase or decrease temperatures by 10°C.

Unless otherwise indicated in the charts food should be placed in a cold oven, i.e. without pre-heating. If food is placed in an already hot oven, the suggested cooking time should be reduced, depending on the type and quantity of food being cooked.

## Oven positions

Since the distribution of heat in the circulaire fan oven is very even, most foods will cook satisfactorily on any shelf position, but the shelves should be evenly spaced.

The top oven rod shelf can be used in the main oven when cooking large quantities of food. Additional shelves can be purchased through your oven supplier or our Spares department (see Key Contents, back cover).

**Food or utensils should Never be placed directly on the floor of the oven for cooking.**

Never use more than 3 shelves in the oven as air circulation will be seriously restricted. To ensure oven circulation do not use meat pans larger than 390 x 300mm (15"x12") and baking trays no larger than 330 x 255mm (13"x 10"), these should be positioned centrally on the oven shelf. Food should not be placed directly on the floor of the oven. To avoid unnecessary cleaning, rod shelves which are not in use, should be removed from the oven.

## Temperature and time

When all three shelves are used to cook large quantities of food for home freezing or parties, it may be necessary to increase the cooking times given in the temperature charts by a few minutes, to allow for the loss of heat due to extra time taken to load the oven, and the larger mass of food. Baking trays should have an equal gap at either side of the oven.

## Frozen meat and poultry

Joints of meat and whole birds should be defrosted slowly, preferably in a domestic refrigerator (allowing 5-6 hours per 450g (1 lb), or at room temperature (allowing 2-3 hours per 450g (1 lb)).



# Oven Temperature Charts – Meat

Top Oven Cooking				Fan Oven Cooking (all models)				
Meat	Pre-heat	Temperature °C	Time (approx.)	Position in Oven	Meat	Pre-heat	Temperature °C	Time (approx.)
Beef/ Lamb (slow roasting)	Yes	170/180	35 mins per 450g (1lb) + 35 mins over.	Runner 1 from bottom of oven.	Beef	No	160/180	20-25 mins per 450g (1lb) + 20 mins extra
Beef/ Lamb (foil covered)	Yes	190/200	35-40 mins per 450g (1lb)		Lamb	No	160/180	25 mins per 450g (1lb) + 25 mins extra
Pork (slow roasting)	Yes	170/180	40 mins per 450g (1lb) + 40 mins over		Pork	No	160/180	25 mins per 450g (1lb) + 25 mins extra
Pork (foil covered)	Yes	190/200	40 mins per 450g (1lb)		Veal	No	160/170	25-30 mins per 450g (1lb) + 25 mins extra
Veal (slow roasting)	Yes	170/180	40-45 mins per 450g (1lb) + 40 mins over		Chicken/Turkey up to 4kg (8lb)	No	160/180	18-20 mins per 450g (1lb) + 20 mins extra
Veal (foil covered)	Yes	190/200	40-45 mins per 450g (1lb)		Turkey up to 5.5kg (12lb) over 5.5kg (12lb)	No	150/160	13-15 mins per 450g (1lb) e.g. 5kg (11lb) = 143-165 mins 12 mins per 450g (1lb) e.g. 10kg (22lb) = 264 mins
Poultry/Game (slow roasting)	Yes	170/180	25-30 mins per 450g (1lb) + 25 mins over		Casserole Stews	No	140-150	1 1/2 - 2 hrs
Poultry/Game (foil covered)	Yes	190/200	25-30 mins per 450g (1lb)					
Casserole Cooking	Yes	150	2-2 1/2 hrs					

**If using aluminium foil, never:** **1.** Allow foil to touch sides of oven. **2.** Cover oven interior with foil. **3.** Cover shelves with foil.

The most accurate method of testing the readiness of joints of meat or whole poultry is to insert a meat thermometer into the thickest part of a joint, or the thickest part of poultry thighs, during the cooking period. The meat thermometer will indicate when the required internal temp has been reached.

<b>Beef -</b>	Rare:	60°C	<b>Lamb:</b>	80°C	<b>Poultry:</b>	90°C
	Medium:	70°C	<b>Pork:</b>	90°C		
	Well Done:	75°C	<b>Veal:</b>	75°C		

## Oven Temperature Charts – Baking

Baking	Top Oven Cooking			Fan Oven Cooking (all models)			
	Pre-heat	Temperature °C	Time in mins.	Position In Oven	Pre-heat	Temperature °C	Time in mins.
Scones	Yes	201/220	10-15	Runner 1 from bottom of oven	Yes	210/220	8-10
Small Cakes	Yes	180/190	20-25	Runner 1 from bottom of oven		170/180	15-20
Victoria Sandwich	Yes	170/180	20-30	Runner 1 from bottom of oven		160/170	20-25
Sponge Sandwich	Yes	180/190	20-25	Runner 1 from bottom of oven	Yes	170/190	15-20
Swiss Roll	Yes	200/210	10-15	Runner 1 from bottom of oven	Yes	180/200	12-15
Semi-rich Fruit Cakes	Yes	150/160	60-75 7 inch	Runner 1 from bottom of oven		140/150	75-90
Rich Fruit Cakes	Yes	140/150	Depending on size	Runner 1 from bottom of oven		130/140	Depending on size.
Shortcrust Pastry	Yes	190/200	Depending on recipe	Runner 1 from bottom of oven		190/200	45-50
Puff Pastry	Yes	200/210	Depending on recipe	Runner 1 from bottom of oven		190/200	Depending on use.
Yorkshire Pudding	Yes	190/200	30-40	Runner 2 from bottom of oven	Yes	180/190	40-45
Individual Yorkshire Puddings	Yes	200/210	20-30	Runner 2 from bottom of oven	Yes	190/200	20-25
Milk Pudding	Yes	140/150	90-120	Runner 1 from bottom of oven		130/140	105-135
Baked Custard	Yes	150/160	40-50	Runner 1 from bottom of oven		140/150	40-50
Bread	Yes	200/210	30-45	Runner 1 from bottom of oven	Yes	200/210	45-50
Meringues	Yes	100	150-180	Runner 2 from bottom of oven		80-90	180-240

**Note:** If soft margarine is used for cake making, temperatures recommended by the manufacturers should be followed. Temperatures recommended in this chart refer to cakes made with block margarines or butter only.

---

# Using the Main Oven for other Functions

---

## 'S' SLOW setting

This is used for slow cooking, keeping food warm and warming plates for short periods. Extra care should be taken when warming bone china, as it may be damaged in a hot oven.

**DO NOT place food or plates directly on the oven floor as this could damage both the oven lining and the plates which are being warmed.**

## Advantages of "SLOW" cooking are:

The oven stays cleaner because there is less splashing.  
Timing of food is not as critical, so there is less fear of overcooking.  
Inexpensive joints of meat are tenderised.  
Fully loading the oven can be economical.  
Cooking times can be extended in some cases by up to 2 hours.

## Operation:

1. Place the prepared food in the main oven and ensure the door is fully closed.
2. Select 'S' (Slow Cooking Temperature) by turning Main Oven Temperature Control clockwise ensuring the oven door is fully closed.

## Storage and re-heating of food:

1. If food is to be frozen or not used immediately, place it in a clean container and cool as soon as possible.
2. Always thaw frozen food completely in the refrigerator before re-heating.
3. Always reheat food thoroughly and ensure it is piping hot before serving.
4. Only re-heat food **once**.

## Points to consider when preparing food for "SLOW" cooking:

1. Make sure that the dishes to be used will fit into the oven ensuring enough room for air to circulate.
2. All dishes cooked on the slow setting will require a minimum of 6 hours, however, if they are cooked for 1-2 hours longer then deterioration in their appearance may be noticed.
3. Never cook joints of meat over 2.7kg (6 lb) or poultry over 2.0kg (4 lb 8oz). We do not recommend that joints of meat or poultry are stuffed before cooking on the slow setting.
4. To seal in the meat juices, always cook meat or poultry at 170°C for 30 minutes before wrapping in foil and placing on a rack over a tin (to allow good air circulation) before turning the control to the slow setting and cooking immediately.
5. Always ensure that joints of pork and poultry are thoroughly cooked by checking with a meat thermometer before serving.
6. Always thaw frozen foods completely before cooking. We do not recommend placing frozen food in the oven to cook.
7. Always bring soups, liquids and casseroles to the boil before placing in the oven.
8. Ensure that casserole dishes have a good seal (not airtight) and cover to the top with foil to prevent loss of moisture.
9. Ensure that fruit and vegetables are cut into even sized small pieces to cook properly.
10. Always adjust seasoning before serving.
11. If using dried red kidney beans it is important that the beans are soaked and then boiled for a minimum of 10 minutes before using in any dish to destroy any toxins.
12. When cooking fish or egg dishes it may be necessary to check during cooking to avoid overcooking.

---

# Care and Cleaning

---



**TURN OFF THE MAIN SWITCH AND ENSURE THE COOKER IS COLD BEFORE CLEANING. BEFORE SWITCHING ON AGAIN, ENSURE THAT ALL CONTROLS ARE IN THE OFF POSITION.**

**NEVER USE BIOLOGICAL WASHING POWDER, HARSH ABRASIVES, SCOURING PADS, AEROSOL CLEANERS OR OVEN CHEMICAL CLEANERS OF ANY KIND, UNLESS SPECIFIED BELOW.**

## **Cleaning materials to avoid:**

1. Plastic or nylon pads
2. Household abrasive powders and scourers. These may scratch the surface.
3. Oven chemical cleaners, aerosols and oven pads.  
Caustic cleaners such as these will etch the surface and attack the metal frame.
4. Bath and sink cleaners may mark the surface.

**ALWAYS SWITCH OFF AT THE MAINS SWITCH BEFORE CLEANING.**

---

# Care and Cleaning

---

## **Ceramic hotplates (C361E, C362E, C363E and C366E):**

Clean your Ceramic hob top regularly and avoid repeated burning of encrusted contamination.

Your choice of cleaner will depend on the degree of soiling involved (see below).

- **minor soiling**, where the contamination has not burnt hard, can be wiped off with a clean wet cloth
- **major soiling** and strongly-adhering burnt encrustation can be quickly and easily removed with a razor-blade scraper
- hard water stains, grease spots and discoloration having a metallic sheen can be removed with 'Easy Do Cleaner Powder'
- always condition hob after cleaning by using 'Easy Do Conditioner' or 'Hob Brite'. Apply a small amount of conditioner with a clean damp cloth or paper towel. Rub vigorously. Remove excess with a clean damp cloth or paper towel. Polish with a clean cloth or paper towel before the conditioner dries.

Detergent residues must always be completely removed with a clean wet cloth, (even if the instructions for use suggest otherwise), as they can have an etching effect when reheated. Then wipe dry.

To maintain hob in good condition, we would recommend regular use of the 'Easy Do Powder Cleanser'.

Sprinkle Powder Cleanser on a clean damp cloth or paper towel and rub vigorously for 3 to 4 minutes. Remove all residue with a clean damp cloth or paper towel. Then use conditioner to protect the hob.

For more stubborn marks, mix a small amount of the powder cleanser with 'Cif Lemon Juice' (from a bottle) and carefully spread over the affected area. Cover with a damp paper towel and leave for a minimum of 15 minutes. Rub vigorously. Remove excess with a clean damp cloth or paper towel before the conditioner dries. Polish with a clean cloth or paper towel.

Easy Do products are available from many electrical retailers and our Parts Department. Homecare 'Hob Brite' is available from leading Supermarkets.

## **Electric sealed hotplates (C262E):**

The cleaning of sealed hotplates should be done when they are cold, using a soap filled Brillo pad, following the grain of the hotplate. This will ensure that any stubborn, burnt on spillages are removed. Wipe over with a damp clean cloth, making sure that all the cleaner has been removed. Finally, turn on hotplate to warm for a few minutes, then smear with a little cooking oil to provide a protective coating, or the restorative agent Homecare Four Hob, available from our Parts Department or leading supermarkets. The bezels will mellow with use to a burnished gold colour, a soap filled Brillo pad will help to keep them bright, care should be taken not to damage the vitreous enamel hob surface.

**Note: We do not recommend the use of decorative covers over the hot hotplates as these can hold condensation and cause corrosion. Accidental operation with a cover in place can cause intense heat. Never place saucepan lids on the hotplates, as this may cause corrosion.**

---

# Care and Cleaning

---

## 'STAY CLEAN' Oven liners

Refer to the instructions below for cleaning the 'Stay clean' panels.

### How "STAY CLEAN" works:

The surfaces of the 'Stay clean' oven liners are treated on the mottled face with a special vitreous enamel which absorbs cooking soils. At temperatures of 220°C (425°F) or above, the special surface enables these soils to be slowly destroyed. The higher the temperature the more effective it is. In most cases normal cooking operations at this temperature will permit this cleaning operation to proceed during cooking. However if higher cooking temperatures are not used regularly it may be necessary in order to prevent heavy soiling, to run the oven without a meat pan at maximum setting for a couple of hours.

**Main Oven Liners** - side and rear panels.

**Top Oven Liners** - sides

It should not normally be necessary to clean the 'Stay clean' panels in water. If the user feels it is desirable to do so, wash them in warm soapy water, followed by rinsing in clean water. **Do not use enzyme/biological washing powder, harsh abrasives or oven chemical cleaners of any kind.**

### Decorative trims (all models) / Vitreous enamel hob (C262E):

It is advisable to clean the decorative trims regularly to prevent any build up of soiling which may detract from the appearance of the cooker. The recommended method of cleaning is to wipe over the trims with a soft cloth wrung out in hot water or mild non-abrasive cleaner. (If in doubt try the cleaner on a small area of trim which is not noticeable in normal use). Then, after wiping with a cloth wrung out in clear water, dry with a soft clean cloth.

**Never use** scouring pads or abrasive cleaners/powders which may scratch the surface.

**Take care** during cleaning not to damage or distort the door seals. Do not lift the door seal from the oven chassis, if necessary remove the seal by carefully unhooking the corner clips.

**Take care** that the rating label edges are not lifted during cleaning, and furthermore that the lettering is not blurred or removed.

### Control Panel:

Wipe with a damp cloth and polish with a dry cloth.

### Stainless trims (C363E only)

Regularly wipe with a clean, damp cloth and polish with a clean dry cloth.

### Grill Door:

Wipe over the grill door decorative outer panel; with a cloth wrung out in warm soapy water, then after wiping with a cloth wrung out in clear water, dry with a soft clean cloth.

**Do not use scouring pads or abrasive powder which may scratch the surface. Ensure that the glass panel is not subjected to any sharp mechanical blows.**

---

# Care and Cleaning

---

## Grill:

Remove the grill pan and the wire grid food support, it is best to wash these items immediately after use to prevent stains from being burnt on when used again. Wipe out the Grill compartment, use a fine steel wool soap pad to remove stubborn stains from the grill deflector plate (C361E & C366E) and the floor of the compartment.

## Main oven / Grill:

1. **Glass Door** – open the oven door fully. The glass panel may now be cleaned. Stubborn stains can be removed by using a fine steel wool soap pad. **Do not use scouring pads, or abrasive powder, which will scratch the glass. Ensure that the glass panel is not subjected to any sharp mechanical blows.**

For slight soiling the inner glass panel may be cleaned, while still warm. For removing stubborn stains see next page, cleaning .

2. Remove the rod shelves and meat pan.  
Use a fine steel wool soap pad to remove stubborn stains from the rod shelves, meat pan and the floor of the oven. Refer to the instructions on previous page for cleaning the 'Stay clean' panels.

**Do not use** aerosol cleaners on this oven as they could adversely affect the fan motor unit, and cannot be wiped off the fan blade.

## Replacement oven lamp:

**WARNING: To avoid electric shocks - please ensure that the electricity supply to the appliance is switched off and the appliance is fully cold, before removing the lamp lens.**

Open the oven door and remove the rod shelves. Using a suitable cloth to protect the fingers grip the light glass dome, unscrew anti-clockwise and lift. Reach into the aperture and unscrew the lamp anti-clockwise. Fit replacement lamp (15W 300°C rated SES), refit dome.

## Wall-mounted splashpanel:

A wall-mounted splashpanel is available as an optional extra from the Spare Parts Department. See back cover for details.

Care must be taken that rating label edges are not lifted during cleaning and furthermore that the lettering is not blurred or removed.

For details of your nearest Service Centre please see the separate service leaflet. If you have any queries regarding service or spares, our Spares and Service Division will be pleased to advise. See back cover for details.

---

# Care and Cleaning

---

Take particular care not to damage the inner surface of the door inner glass that is coated with a heat reflective layer. Do not use scouring pads, or abrasive powder, which will scratch the glass. Ensure that the glass panel is not subjected to any sharp mechanical blows.

Stubborn stains can be removed by using a fine steel wool pad. For slight soiling the inner glass panel may be cleaned, while still warm, without removing it from the door. After cleaning, rinse and dry with a soft cloth.

## CLEANING THE DOORS

### SIDE OPENING DOORS

Cleaning the door glass is the same as the drop down doors, except take care to support the weight of the inner glass when removing and refitting.

### DROP DOWN DOORS

Remove the door inner glass as follows.

1. Open the door fully and unscrew the two screws securing the glass panel so that the securing brackets can be turned. There is no need to remove the screws completely.
2. Turn the brackets so that the glass can be removed and cleaned at the sink (Fig. 1.)

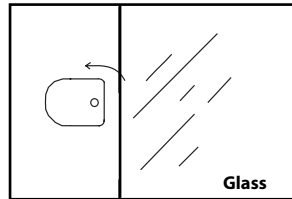

Fig. 1.

3. The inside of the outer door glass can now be cleaned while still fitted to the cooker.

## NEVER OPERATE THE COOKER WITHOUT THE INNER DOOR GLASS IN POSITION.

Refit the door inner glass as follows.

1. **NOTE:** The inner door glass has a special reflective coating on one side. Replace the door inner glass so that the statement: **"IMPORTANT THIS FACE TOWARDS THE OVEN"** can be read from the inner side of the door.
2. Turn the two securing brackets back to their original position to retain the glass and tighten the screws (Fig. 2.)

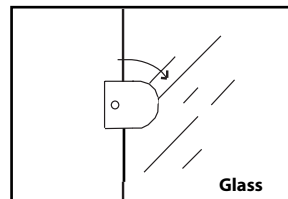

Fig. 2.



# Cooking Results Not Satisfactory?

Problem	Check
<b>Grilling</b> Uneven cooking front to back	Ensure that the grill pan is positioned centrally below the grill element.
Fat splattering	Ensure that the grill is not set to too high a setting.
<b>Baking (General)</b> Uneven rising of cakes	Ensure that the oven shelves are level by using a spirit level on the rod shelf and adjusting the wheels/feet. The oven should be checked both left to right and front to back.
Sinking of cakes	The following may cause cakes to sink: <ol style="list-style-type: none"> <li>1. Preheating of fan ovens.</li> <li>2. Cooking at too high a temperature.</li> <li>3. Using normal creaming method with soft margarine use the all-in-one method.</li> <li>4. If using soft margarine use the all-in-one method</li> </ol>
Over/Under cooking Fast/Slow cooking	Refer to the cooking times and temperatures given in the oven temperature charts, however, it may be necessary to increase or decrease temperatures by 10°C to suit personal taste.  Do not use utensils greater than 56mm (2¼ins) in height.
Uneven cooking of cakes	<ol style="list-style-type: none"> <li>1. Too large baking sheet used (see 'Cookery Notes', page 36 for correct sizes).</li> <li>2. Over loading of oven and always ensure even air gaps around baking tins.</li> <li>3. Placed into pre-heated oven (see oven temperature charts).</li> </ol>
<b>Top Oven Baking</b> Uneven cooking front to back	Ensure the cooking utensil is at least 4ins from the front of the shelf.
Uneven rising of cakes	Ensure that the shelf is level (see above) and that the food is positioned centrally in the oven.
Overcooking	Remember to reduce cooking temperatures by 10°C from standard recipes when using the top oven.
Food is taking too long to cook	Ensure that the cooking utensil used in the top oven is not larger than 300x225mm (12ins x 9ins), e.g. the main oven meat pan.  Only cook one item at a time to avoid overloading the oven.

---

# Something Wrong with your Cooker?

---

Before calling a Service Engineer, please check through the following lists.  
**THERE MAY BE NOTHING WRONG.**

Problem	
Slight odour or small amount of smoke when grill / oven used first time	This is normal and should cease after a short period.
Nothing works	If you find that the timer display is blank, then it is likely that there is no electricity supply to your oven. Check: (i) That the main cooker wall is switched on (ii) Other appliances, to see if you have had a power cut (iii) The main circuit breaker for the property
Top oven and grill do not work. Main oven works. Top Oven	Operating the cooker under the following conditions may cause a safety device to operate: (a) Grilling with the door closed - Always grill with the door fully open (b) Grilling for an excessively long period at maximum setting - see Grilling guide. Switch off appliance and allow to cool for approx 30 mins. Switch the cooker back on and check that the Grill / Top oven is now operating.
Grill does not work.	Ensure that the top oven control is turned fully off.
Grill keeps turning on and off.	When the Grill control is operating at less than its maximum setting, the Grill will cycle on and off, this is normal and <b>not</b> a fault.
Timer is showing 0.00	The power supply to your oven has possibly been interrupted, but has now come back on again. Reset the timer to the correct time of day using the instructions given in the timer section of the book.
Timer buzzer operates continually.	To cancel the audible tone: - press the manual button once (C361E & C366E). - press the minute minder button once (C262E, C362E & C363E)

Problem	
Oven temperatures too high or low	Check temperature and shelf positions are as recommended in the Oven Temperature Charts. It may be necessary to increase or decrease the recommended temperature slightly to suit your taste.
Oven does not cook evenly	Check: (a) Temperature and shelf positions are as recommended in the Oven Temperature Charts. (b) Oven utensils being used allow sufficient air flow around them.
Oven lamp does not work	The oven lamp is not covered by the guarantee. The part is easily changed (see the section on oven lamp replacement). A new lamp may be obtained from our Parts department see Key Contacts, back page.
Draught from beneath control panel	A gentle flow of air will be blown from beneath the control panel when the appliance is used. If the appliance is still warm, this cooling fan may run on, or restart itself when all controls have been turned off. The fan will stop once the appliance has been cooled. This is normal and <b>not</b> a fault.
Condensation on the wall at the rear of the cooker.	Steam and / or condensation may appear from the vent at the rear of the appliance when using an oven particularly for foods with a high water content e.g. frozen chips, roast chicken etc. This is normal, and any excess should be wiped off.
Steam / Condensation in the oven after use.	Steam is a by - product of cooking any food with a high water content. To help minimise always: a) Try to avoid leaving food in the oven to cool after being cooked. b) Use a covered container, wherever possible.

**If you have been through the above list and there is still a problem; Contact Service, see Key Contacts (back cover).**



## Key Contacts

### Service

We have the largest appliance manufacturer's service team in Europe, trained specialists directly employed by us to ensure your complete confidence.

### Repair Service

**UK: 08709 066 066**

**Republic of Ireland: 1850 302 200**

You will be asked for the following information:-

Name, address and postcode.

Telephone number

Model / Serial number of the appliance

Clear and concise details of the query or fault

Place and Date of purchase

(Please keep the receipt as evidence will be required when the engineer calls).

### Extended Warranty

**To join: UK 08709 088 088**

**Republic of Ireland: 1850 502 200**

### Genuine Parts & Accessories

### Mail Order Hotline

**UK: 08709 077 077**

**Republic of Ireland: (01) 842 6836**

For further product information 08701 546474

All Services are offered as an extra benefit and do not affect your statutory rights.

**Merloni Elettrodomestici UK Ltd, Morley Way, Peterborough, PE2 9JB**

## Free Manuals Download Website

<http://myh66.com>

<http://usermanuals.us>

<http://www.somanuals.com>

<http://www.4manuals.cc>

<http://www.manual-lib.com>

<http://www.404manual.com>

<http://www.luxmanual.com>

<http://aubethermostatmanual.com>

Golf course search by state

<http://golfingnear.com>

Email search by domain

<http://emailbydomain.com>

Auto manuals search

<http://auto.somanuals.com>

TV manuals search

<http://tv.somanuals.com>