



Instructions for Installation and Use

EG72

EG53

Use and Installation Instructions

The cooker must be installed in accordance with the regulations in force and only used in a well ventilated space.

Read these instructions prior to using the cooker and retain them for future reference.

CONTENTS

	PAGE
Introduction	3
For Your Safety	4
Timer Operation (EG72)	6
Timer Operation (EG53)	12
Hotplate	14
Grill	16
Ovens	17
Oven Cooking Chart	18
The Slow Cooking "S" Setting	20
Care and Cleaning	21
Something Wrong with your cooker?	24
Installation Instructions	26
Key Contacts	Back Cover

INTRODUCTION

To help you make the best use of your cooker, PLEASE READ THIS BOOKLET CAREFULLY.

Your new cooker is guaranteed and will give lasting service. The guarantee is only applicable if the cooker has been installed in accordance with the Installation Instructions.

The cooker is designed specifically for domestic use and responsibility will not be accepted for use in any other installation.

When first using the cooker ensure that the room is well ventilated (e.g. open a window or use an extractor fan) and that persons who may be sensitive to the odour avoid any fumes. It is suggested that any pets be removed from the room until the smell has ceased. This odour is due to any temporary finish and also any moisture absorbed by the insulation.

Our policy is one of continual improvement in design and development, therefore strict accuracy of illustrations and descriptions cannot be guaranteed.



This appliance conforms to the following EEC Directives:

Gas Appliances
90/396/EEC

Low Voltage Equipment
73/23/EEC
93/68/EEC

Electromagnetic Compatibility
89/336/EEC
92/31/EEC
93/68/EEC

FOR YOUR SAFETY

Please read the precautions below before using your cooker.

ALWAYS ...

- ALWAYS make sure you understand the controls before using the cooker.
- ALWAYS check that all controls on the cooker are turned off after use.
- ALWAYS stand back when opening an oven door to allow heat to disperse.
- ALWAYS use dry, good quality oven gloves when removing items from the ovens.
- ALWAYS take care when removing items from the top oven/grill when the main oven is on, as the contents may be hot.
- ALWAYS keep the oven and grill doors closed when the cooker is not in use.
- ALWAYS place pans centrally over the hotplate burners and position them so that the handles cannot accidentally be caught or knocked or become heated by other burners.
- ALWAYS keep the cooker clean, as a build up of grease or fat from cooking can cause a fire.
- ALWAYS allow the cooker to cool before cleaning.
- ALWAYS follow the basic principles of food handling and hygiene to prevent the possibility of bacterial growth.
- ALWAYS keep ventilation slots clear of obstructions.
- ALWAYS turn off the electricity supply before cleaning or replacing the oven lamp.
- ALWAYS refer servicing to CORGI registered appliance service engineers.

FOR YOUR SAFETY

NEVER...

- NEVER leave children unsupervised where the cooker is installed as all surfaces will get hot during and after use.
- NEVER allow anyone to sit or stand on any part of the cooker.
- NEVER store items that children may attempt to reach above the cooker.
- NEVER heat up unopened food containers as pressure can build up causing the container to burst.
- NEVER store chemicals, food stuffs, pressurised containers in or on the cooker, or in cabinets immediately above or next to the cooker.
- NEVER fill a deep fat frying pan more than 1/3 full of oil, and never use a lid.
DO NOT LEAVE UNATTENDED WHILE COOKING.
- NEVER place flammable or plastic items on or near the hotplate.
- NEVER use proprietary spillage collectors on the hotplate.
- NEVER use the cooker as a room heater.
- NEVER dry clothes or place other items over or near to the hotplate or oven/grill doors.
- NEVER wear garments with long flowing sleeves whilst cooking.

NOTE: The use of a gas cooking appliance results in the production of heat and moisture in the room in which it is installed. Always ensure that the kitchen is well ventilated; keep natural ventilation holes open or install a mechanical ventilation device (mechanical extractor hood).

In particular when using more than one hotplate burner, open a window if a mechanical ventilation device is not operating.

Timer Operation (EG72)

The timer offers you the following features:

1. Time of Day
2. Automatic Cooking
3. Minute Minder

AUTOMATIC COOKING

The main oven can be controlled automatically.

GUIDANCE ON AUTOMATIC COOKING

1. Select foods which will take the same time to cook.
2. Set the oven timer so that the food has just finished or is just about to finish cooking on your return to the oven. This will ensure the food has not cooled down and does not require reheating before serving.
3. Food should be as cold as possible when it goes into the oven, ideally straight from the refrigerator. Frozen meat and poultry should be thawed thoroughly before it is put in the oven.
4. Warm food should never be placed in the oven if there is to be a delay period. Stews prepared by frying the meat and vegetables should be cooked as soon as possible.
5. Dishes containing left-over cooked poultry or meat, for example Shepherds Pie, should not be cooked automatically if there is to be a delay period.
6. Stews and joints should be cooked by the long slow method, so that the delay period is kept to a minimum.
7. On warm days, to prevent harmful bacterial growth in certain foods (ie poultry, joints, etc) the delayed start should be kept to a minimum.
8. Wine or beer may ferment and cream may curdle during the delay period, so it is best to add these ingredients just before serving.
9. Foods which discolour should be protected by coating in fat or tossing in water to which lemon juice has been added, prior to placing food in the oven.
10. Dishes containing liquid should not be filled too full to prevent boiling over.
11. Food should be well sealed (but not airtight) in a container to prevent the loss of liquid during cooking. Aluminium foil gives a good seal.
12. Ensure food is cooked thoroughly before serving.

Timer Operation (EG72)

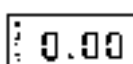

CLOCKFACE

The timer incorporates a 24 hour clock.

Ensure the correct time of day is always set, before using your cooker.

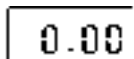
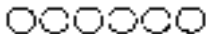

SYMBOLS

A 'bell' symbol will light up when you select a Minute Minder Period and will remain lit for the period set.

At the end of the Minute Minder Period, the timer will emit an audible tone and the 'bell' symbol will disappear.

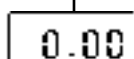
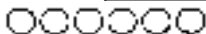

- The 'cookpot' symbol will light up either:-
- When the timer is in manual mode, or
 - During the actual Cook Period.

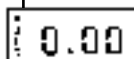
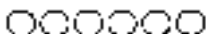

'AUTO' will light up:-

- When the timer is first turned on it will flash. It will go out when a time of day is set or when the timer is set to manual.

The 'AUTO' symbol will flash at the end of an Auto Cooking programme to indicate that the programme has finished.

(When the 'AUTO' symbol is flashing, to return the oven to Manual operation, turn the oven controls off, ensure that the correct time of day is set, and press the "Manual" button - The 'AUTO' symbol will go out.)

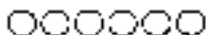

TIMER FUNCTION BUTTONS

Minute Minder Button

Here you can set a time period of up to 23 hours 59 minutes, that will count down. When it reaches zero, the timer will emit an audible tone.

For Example: If you set 20 minutes, the audible tone will occur 20 minutes later.

AUTO COOKING PROGRAMME

Cook Period Button

Cook Period is the actual length of time for which, the timer will switch the oven(s) on as part of an "Auto Cooking" programme.

(e.g. If you set 2 hours, the food will be cooked for 2 hours).

End Time Button

The time of day at which you want an "Auto Cooking" programme to **end**.

For Example: If you set a "Cook Period" for 2 hours, and "End Time" of 11:00. The timer will switch the oven(s) on at 9:00 and turn the oven(s) off at 11:00. You will hear a audible tone at 11:00, to indicate that the Auto Cooking Programme has finished.

Notes:

- When setting an Auto Cooking programme you will need to set the oven control(s) to the required temperature(s) when you set the timer.
- If an Auto Cooking programme has been set the oven(s) will only operate during the pre-programmed time.

Manual Button

Needs to be pressed to cancel an Auto Cooking programme and return the oven(s) to Manual operation.

"+" and "-" Buttons

Used to adjust the various timer function settings.

Timer Operation (EG72)

SETTING THE TIME OF DAY

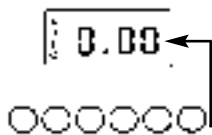

Step 1 Make sure all oven controls are turned Off.

Step 2 Check the electricity supply to the cooker is turned on.

Step 3 When switched on the display will show 0.00 and the Auto symbol, flashing intermittently.

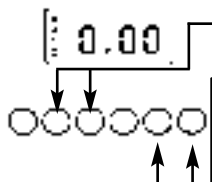

Step 4 Press & hold in both the Cook Period & End Time buttons together.

Step 5 With the Cook Period & End Time buttons still held in, press either the "+" or "-" buttons to set the correct time of day.

Step 6 Release all the buttons simultaneously.

THE TIME OF DAY IS NOW SET.

To change the time of day repeat Steps 4, 5 & 6 above.

Note: You cannot adjust the time of day if the timer has been set for an Auto Cooking Programme.

SETTING THE MINUTE MINDER

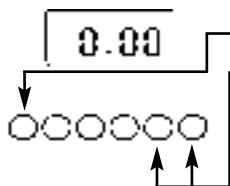

Step 1 Ensure the time of day is set correctly.

Step 2 Press and hold the Minute Minder button.

Step 3 With the Minute Minder button held in, set the required Minute Minder period using the "+" and "-" buttons. A 'bell' symbol will light up.

Release all buttons and the timer display will revert back to the time of day. The 'bell' symbol will remain lit to signify that a Minute Minder period has been set.

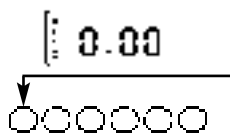

At the end of the set time an audible tone will be heard, and the 'bell' symbol will disappear.

Step 4 To cancel the audible tone press the Minute Minder button.

Note 1 When the Minute Minder has been set, the time remaining can be checked at any time by simply pressing the Minute Minder button.

Note 2 If necessary the Minute Minder can be cancelled before the tone sounds by pressing and holding the Minute Minder button and then at the same time pressing the "-" button until 0.00 appears in the display window.

Timer Operation (EG72)

AUTO COOKING PROGRAMMES

There are two Auto Cooking programmes that can be selected using your timer:-

- To set the timer to switch the oven(s) On and Off Automatically
- To set timer to switch on immediately and OFF automatically after a set cook period.

a) TO SET THE TIMER TO SWITCH THE OVEN(S) ON AND OFF AUTOMATICALLY

This allows you to cook at a specified time for a chosen period before the oven switches off Automatically.

- Step 1** Check that the correct time of day is set, if not follow instructions for setting the time of day.
Step 2 Place food onto the correct shelf position in the oven and close the oven door(s).

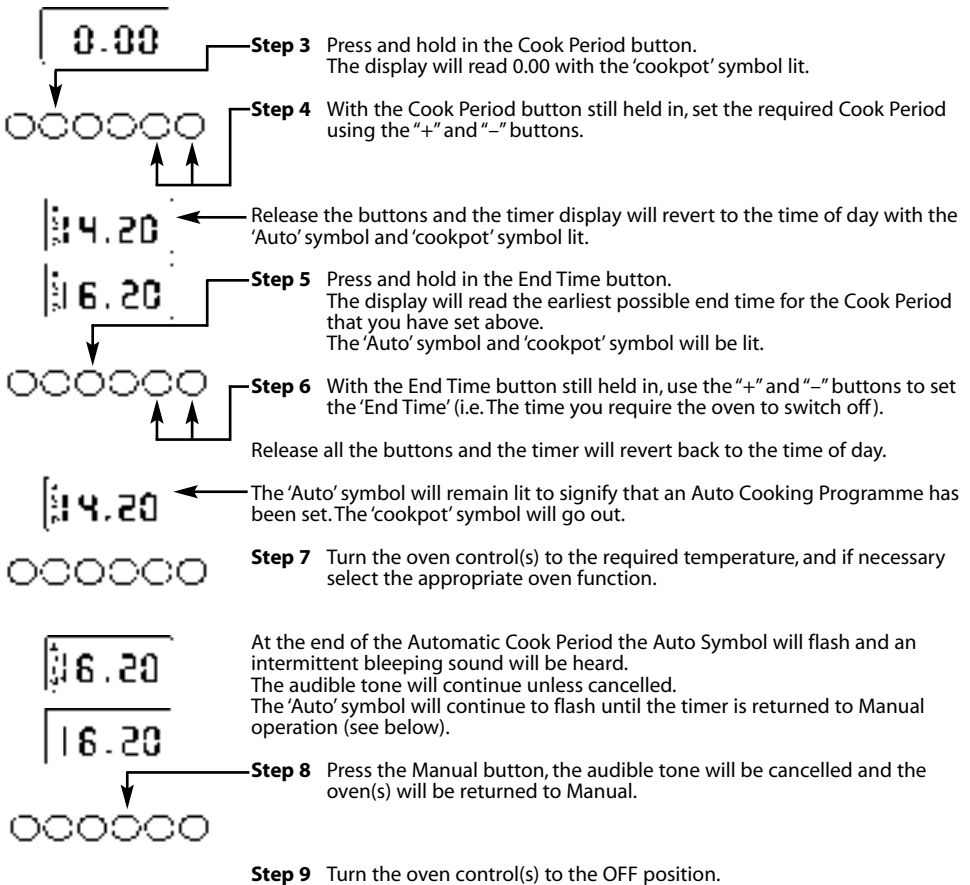

Timer Operation (EG72)

Note 1 When cooking automatically the Cook Period can be checked at any time by simply pressing the Cook Period button.

Note 2 When cooking automatically the End Time can be checked at any time by simply pressing the End Time button.

b) TO SET TIMER TO SWITCH ON IMMEDIATELY AND OFF AUTOMATICALLY AFTER A SET COOK PERIOD

- Step 1** Check that the correct time of day is set, if not follow instructions for setting the time of day.
Step 2 Place food onto the correct shelf position in the oven and close the oven door(s).
Step 3 Turn the oven control(s) to the required temperature, and if necessary select the appropriate oven function.

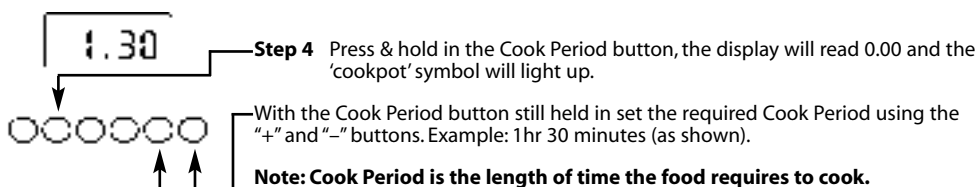

Step 5 Release all buttons.

The timer display will revert to the time of day with the 'Auto' symbol lit & 'cookpot' symbol remaining lit.

NOTE: The Cookpot symbol disappears

At the end of the Cook Period the 'Auto' symbol will flash and an intermittent audible tone will be heard. The audible tone will continue until cancelled. The 'Auto' symbol will continue to flash until the timer is returned to Manual operation (see below).

Step 6 Press the Manual button. The audible tone will be cancelled and the oven(s) will be returned to Manual.

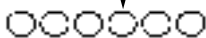

Step 7 Turn the oven control(s) to the OFF position.

Timer Operation (EG72)

TO CANCEL AN AUTO COOKING PROGRAMME BEFORE THE COOK PERIOD HAS FINISHED.

Step 1 Turn the oven control(s) to the OFF position.

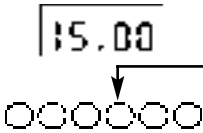

Step 2 Press the Manual button to return the oven(s) to "Manual" operation. The 'Auto' symbol will go out.

Note 1 When cooking automatically the Cook Period can be checked at any time by simply pressing the Cook Period button.

OTHER NOTES ON TIMER OPERATION

1. When cooking Automatically the Cook Period can be checked at any time simply by pressing the Cook Period button.
2. When cooking Automatically the End Time can be checked at any time by simply pressing the End Time button.
3. Having set a Cook Period and End Time an electronic device stores the information. The device within the timer will switch the oven(s) on and off at the required times.
4. When setting an Auto Cooking Programme and a mistake is made, to clear:-
 - (a) Press & release the Manual button.
 - (b) Start the sequence again.
5. If at any time the display shows three flashing zero's 0.00 and 'Auto', it is likely that the electricity supply to the oven has been interrupted. Reset the timer to the correct time of day.
Food in the oven may, therefore, not have been cooked, before serving check food is thoroughly heated and completely cooked.
6. To set each function always press and hold the required function button and at the same time press "+" or "-" buttons.

Timer Operation (EG53)

CLOCKFACE

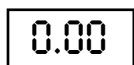

The timer incorporates a 24 hour clock.



SYMBOLS

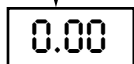

A 'Bell' symbol will light up when you select a Minute Minder Period and will remain lit for the period set.

At the end of the Minute Minder Period, the timer will emit an audible tone and the 'Bell' symbol will disappear.



**Minute
Minder**

SETTING THE TIME OF DAY

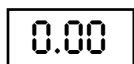

Step 1 Make sure all oven controls are turned off.

Step 2 Check the electricity supply to the cooker is turned on.



Step 3 When switched on, the display will show 0.00

Step 4 Press and release both buttons simultaneously.

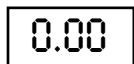

Step 5 Press the '+' button to set the Time of Day. The Time of Day can be adjusted, by using the '+' button to increase the time setting or the '-' button to decrease the time setting. The Time of Day is set if no adjustments are made within 10 seconds.

THE TIME OF DAY IS NOW SET.

To change the time of day repeat Steps 4 & 5 above.

Timer Operation (EG53)

Here you can set a time period of up to 10 hours, that will count down. When it reaches zero, the timer will emit an audible tone.

For Example: If you set 20 minutes, the audible tone will occur 20 minutes later.

SETTING THE MINUTE MINDER

Step 1 Ensure the time of day is set correctly.

Step 2 Press and release the '+' button.

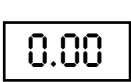

Step 3

Press the '+' button to set the required time period.

A 'Bell' symbol will light up.

The time period can be adjusted, by using the '+' button to increase the time period or the '-' button to decrease the time period.

Note: Step 3 must be started within 10 seconds, otherwise you must repeat Step 2.

Release all buttons, the timer display will show the remaining time period. The 'Bell' symbol will remain lit to signify that a time period has been set.

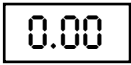

At the end of the set time an audible tone will be heard and the 'Bell' symbol will disappear.



Step 4 To cancel the audible tone press the '+' button.

To cancel the minute minder period press the '-' button until 0.00 is displayed in the window then press the '+' button.

If at any time the display shows flashing zero's, it is likely that the electricity supply has been interrupted.

Reset the timer to the correct time of day.

Note: The Timer display will show the minute minder period as follows:

Any period up to 99 minutes and 50 seconds -

The display shows MINUTES and SECONDS (10s intervals)
eg. 19 minutes 50 seconds

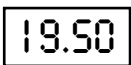

Any period between 100 minutes (1 hour 40 minutes) and up to 10 hours -

The display shows HOURS and MINUTES
eg. 1 hour 41 minutes

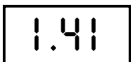

HOTPLATE

The hotplate lid is fitted with a safety device which cuts off the gas supply to the hotplate burners unless the lid is fully open. Do not use the safety device as a means of controlling the hotplate burners.

The hotplate has two high speed burners and two simmering burners which will accommodate pans between 100mm (4") and 230mm (9") diameter. All pans should be positioned centrally over the burners.

TO USE THE HOTPLATE

1. Remove any items or spillage from the top of the lid and then raise it to its fully open position.
2. Press the ignition button and then push in and turn the control knob of the chosen burner anti-clockwise to the large flame symbol. Continue to press the ignition button until the sparks light the gas.
3. Turn the control knob anti-clockwise to the desired setting.
Only turn the control knob between the large flame symbol and the small flame symbol for adjusting the setting.
4. To turn off, turn the control knob fully clockwise to the symbol **O**.

DO NOT use the hotplate unless all pan supports are in position.

DO NOT use mis-shapen pans which may be unstable.

DO NOT use round base woks directly on the pan supports.

DO NOT use the glass lid as a working surface.

Each burner is fitted with a spark ignitor for lighting the gas. To ensure rapid lighting of the burners every time they are used, the ignitors must be kept **clean and dry**. Remove any food spillage or cleaning materials from the ignitor using a small nylon brush such as a tooth brush. Access to the ignitor can be achieved by lifting off the loose burner parts carefully when the burners are cool.

When the hotplate burner bodies and caps are removed for cleaning, be careful not to drop any food particles or cleaning materials into the burner bases, to avoid the possibility of blocking the gas jets.

If aluminium based pans are used, a silvery deposit may appear on the top edge of the pan support fingers. See 'Care and Cleaning' section for cleaning information.

When the hotplate burners are turned down, a slight 'popping' noise may be heard. This is perfectly normal.

HOTPLATE

SAFETY REQUIREMENTS FOR DEEP FAT FRYING

1. Never fill chip pans more than one third full with oil or fat.
2. Never leave oil or fat unattended during the heating or cooling period.
3. Never heat fat or fry with a lid on the pan.
4. Always dry food thoroughly before frying, and lower it slowly into the hot oil or fat. Frozen foods in particular will cause frothing and spitting if added too quickly.
5. Always keep the outside of the pan clean and free from streaks of oil or fat.

HOW TO DEAL WITH A FAT FIRE

1. Do not move the pan.
2. Turn off the hotplate burners.
3. Smother the flames with a fire blanket or damp cloth to extinguish the fire. Do not use water or a fire extinguisher as the force of it may spread the burning fat or oil over the edge of the pan.
4. Leave the pan for at least 60 minutes before moving it.

GRILL

CAUTION – ACCESSIBLE PARTS MAY BECOME HOT WHEN THE GRILL IS IN USE. YOUNG CHILDREN SHOULD BE KEPT AWAY.

GRILLING SHOULD NEVER BE UNDERTAKEN WITH THE GRILL DOOR CLOSED.

The grill control is designed to provide variable heat control of either the full width of the grill or just the left half. Turning the control knob clockwise will switch on the full width and turning anti-clockwise will switch on just the left half.

A gentle flow of air will be blown from underneath the control panel when the grill or ovens are in use.

GRILL PAN HANDLE

The grill pan handle is detachable from the pan to facilitate cleaning. The handle can be either detachable from or fixed to the pan.

Remove the screw and washer from the grill pan bracket, tilt the handle over the recess adjacent to the bracket (A). Slide the handle toward the centre of the pan (B) and let the handle locate over the bracket (C).

For a detachable handle: Remove the screw and washer from the grill pan and keep safe.

For a fixed handle: Replace the screw and washer and ensure they are fully tightened.

Warning: Ensure when using grill pan handle in the detachable manner it is centralised and secure.



TO USE THE GRILL

1. Open the grill/top oven door and place the shelf in the required position.
2. Turn the grill control knob clockwise to **4** for full width grilling or anticlockwise for the half grill.
3. Slide the grill pan toward the back of the grill compartment until it stops.
4. Leave the control at **4** for toast and for sealing and fast cooking of foods. For thicker foods requiring longer cooking, turn the control to a lower setting after sealing on both sides at **4**.

NOTE: The grill will not operate unless the top oven control is in the OFF position.

Grilling can be started from cold but for best results preheat for approximately 2 minutes.

DO NOT cover the grill pan or grid with aluminium foil as this can hold fat, intensify the heat and cause a fire hazard.

OVENS

Both ovens have a thermostat light that will illuminate until the oven has reached the set temperature. It will then switch off and on during cooking as the thermostat maintains the temperature.

Each shelf has a safety stop to prevent it from being pulled out too far when attending to food. Shelves are removed by pulling them out to the stop and then lifting at the front to withdraw. Never withdraw loaded shelves beyond their safety stop position. The oven cooking charts are a guide only, giving approximate cooking temperatures and times. To suit personal taste and requirements it may be necessary to increase or decrease temperatures by 10°C.

A gentle flow of air will be blown from underneath the control panel when the ovens or grill are in use.

TOP OVEN - CONVENTIONAL COOKING

The top oven can be used to cook small quantities of food or used in conjunction with the main oven to provide additional cooking space.

TO USE THE TOP OVEN

1. Place oven shelf in chosen position (refer to cooking chart).
2. Turn the top oven control knob clockwise to the required setting. The top oven thermostat light will go off when the oven has reached the set temperature.

Food should be placed in the centre of the shelf with a gap of at least 25mm (1 inch) between it and the grill element to avoid burning and ensuring an even cooking. Do not place food or dishes on the floor of the oven.

MAIN OVEN - FAN COOKING

Fan cooking is ideal for large poultry or joints of meat, reducing cooking times and often eliminating the need for preheating the oven. It is also ideal for batch cooking where food is cooked on more than one level, because the forced circulation of hot air gives an even temperature from the top to the bottom of the oven.

When cooking recipes that are not designed for a fan oven, it is recommended that the temperature is reduced by about 25°C and the time reduced by about 10 minutes for each hour. If a large quantity of food is being cooked, it will be necessary to increase the cooking time to compensate for the extra oven load.

TO USE THE MAIN OVEN

1. Check that the timer is set to manual mode (EG72 only).
2. Place oven shelves in chosen position (refer to cooking chart).
3. Turn the main oven control knob clockwise to the required setting. Pre-heating is not normally necessary, but some foods such as bread, scones and Yorkshire pudding do benefit from being placed in a hot oven.

Food should be placed in the centre of each shelf to allow for even air circulation around the food.

OVEN COOKING CHART

Top Oven Cooking			Fan Oven Cooking					
Meat	Pre-heat	Temperature °C	Time (approx.)	Position in Oven	Meat	Pre-heat	Temperature °C	Time (approx.)
Beef/ Lamb (slow roasting)	Yes	170/180	35 mins per 450g (1lb) + 35 mins over.	Runner 1 from bottom of oven.	Beef	No	160/180	20-25 mins per 450g (1lb) + 20 mins extra
Beef/ Lamb (foil covered)	Yes	190/200	35-40 mins per 450g (1lb)		Lamb	No	160/180	20-30 mins per 450g (1lb) + 25 mins extra
Pork (slow roasting)	Yes	170/180	40 mins per 450g (1lb) + 40 mins over		Pork	No	160/180	25-30 mins per 450g (1lb) + 25 mins extra
Pork (foil covered)	Yes	190/200	40 mins per 450g (1lb)		Veal	No	160/170	25-30 mins per 450g (1lb) + 25 mins extra
Veal (slow roasting)	Yes	170/180	40-45 mins per 450g (1lb) + 40 mins over		Chicken/ Turkey up to 4kg (8lb)	No	160/180	18-20 mins per 450g (1lb) + 20 mins extra
Veal (foil covered)	Yes	190/200	40-45 mins per 450g (1lb)		Turkey 4 to 5.5kg (8 to 12lb)	No		13-15 mins per 450g (1lb) at 150/160°C allow 12 mins per 450g at 150°C
Poultry/Game (slow roasting)	Yes	170/180	25-30 mins per 450g (1lb) + 25 mins over		Casserole	No	140-150	1 1/2 - 2 Hrs
Poultry/Game (foil covered)	Yes	190/200	25-30 mins per 450g (1lb)					
Casserole	Yes	150	2-2 1/2 hrs					

If using aluminium foil, never: 1. Allow foil to touch sides of oven. 2. Cover oven interior with foil. 3. Cover shelves with foil.

The most accurate method of testing the readiness of joints of meat or whole poultry is to insert a meat thermometer into the thickest part of a joint, or the thickest part of poultry thighs, during the cooking period. The meat thermometer will indicate when the required internal temp has been reached.

Beef - Rare: 60°C Lamb: 80°C Poultry: 90°C
 Medium: 70°C Pork: 90°C
 Well Done: 75°C Veal: 75°C

OVEN COOKING CHART

Baking	Top Oven Cooking				Fan Oven Cooking		
	Food	Pre-heat	Temperature °C	Time in mins.	Position in Oven	Pre-heat	Temperature °C
Scones	Yes	210/220	10-15	Runner 1 from bottom of oven.	Yes	210/220	8-10
Small Cakes	Yes	180/190	20-25	Runner 1 from bottom of oven.		170/180	15-20
Victoria Sandwich	Yes	170/180	20-30	Runner 1		160/170	20-25
Sponge Sandwich (fatless)	Yes	180/190	20-25	Runner 1 from bottom of oven.	Yes	170/190	15-20
Swiss Roll	Yes	200/210	10-15	Runner 1 from bottom of oven.	Yes	180/200	12-15
Semi-rich Fruit cakes	Yes	150/160	60-75 7 inch	Runner 1		140/150	75-90
Rich Fruit Cakes	Yes	140/150	Time Dependent on size	Runner 1		130/140	Depending on size
Shortcrust Pastry	Yes	190/200	Time Dependent on recipe	Runner 1 from bottom of oven.		190/200	45-50
Puff Pastry	Yes	200/210	Time Dependent on recipe	Runner 1 from bottom of oven.		190/200	Dependent on use
Yorkshire Pudding	Yes	190/200	30-40	Runner 2 from bottom of oven.	Yes	180/190	40-45
Individual Yorkshire Puddings	Yes	200/210	20-30	Runner 2 from bottom of oven.	Yes	190/200	20-25
Milk Pudding	Yes	140/150	90-120	Runner 1		130/140	105-135
Baked Custard	Yes	150/160	40-50	Runner 1		140/150	40-50
Bread	Yes	200/210	30-45	Runner 1	Yes	200/210	45-50
Meringues	Yes	100	150-180	Runner 2 from bottom of oven.	No	80-90	180-240

Note: If soft margarine is used for cake making, temperatures recommended by the manufacturers should be followed. Temperatures recommended in this chart refer to cakes made with block margarine only.

THE SLOW COOKING 'S' SETTING

The 'S' setting on the main oven thermostat can be used for slow cooking.

PREPARING FOOD FOR SLOW COOKING

1. All dishes cooked by the 'S' setting should be cooked for a minimum 6 hours. They will 'hold' at this setting for a further hour but marked deterioration in appearance will be noticed in some cases.
2. Joints of meat and poultry should be cooked at 170° for 30 minutes before turning to the 'S' setting and never be cooked lower than the middle shelf position.
3. Joints of meat over 6 lbs (2.7kg) and poultry over 4 lbs 8oz (2 kg) should not be cooked using the 'S' setting.
4. Always stand covered joints on a rack over the meat tin to allow good air circulation.
5. A meat thermometer should be used when cooking pork joints and poultry. The internal temperature of the food should reach at least 88°C.
6. This method is unsuitable for stuffed meat and stuffed poultry.
7. Always bring soups, casseroles and liquids to the boil before putting in the oven.
8. Cover casseroles with foil and then the lid to prevent loss of moisture.
9. Always thaw frozen food completely before cooking.
10. Root vegetables will cook better if cut into small pieces.
11. Adjust seasonings and thickenings at the end of the cooking time.
12. Use the zones of heat in the oven, e.g. meringues and milk puddings can be cooked lower in the oven whilst other dishes requiring greater heat can be cooked above them.
13. Egg and fish dishes need only 1-5 hours cooking and should be included in day cooking sessions, when they can be observed from time to time.
14. Dried red kidney beans must be boiled for a minimum of ten minutes after soaking, before inclusion in any dish.

CARE AND CLEANING

Switch off the electricity supply and allow to cool before cleaning the cooker.

Clean the cooker regularly and wipe up spills soon after they occur to prevent them from becoming burnt on. Never use biological washing powder, caustic cleaners, harsh abrasives, scouring pads, steam cleaners, aerosol cleaners or oven chemical cleaners of any kind.

Before moving your cooker ensure that it is cool and note that it is heavy (approximately 70 kg 155 lbs), so you may require assistance. To move the cooker forward, open the top oven/grill door and with both hands positioned under the roof of the compartment, lift and pull forward. Replace by pushing the cooker backwards. Check that the cooker is level. Take care to ensure that any floor covering is not damaged.

OVEN HEAT CLEAN LININGS

The oven side linings are coated with a special enamel which has a continuous cleaning action. The higher the oven temperature the more effective the action. In most cases this cleaning operation will proceed during normal cooking. However, if roasting is done frequently, or high temperatures are not used regularly, it may be necessary to run the oven empty at maximum setting for about two hours. It should not normally be necessary to clean the linings with water, but if desired, wipe them over with a soapy cloth, followed by a wipe with a damp clean cloth.

REPLACEMENT OF OVEN LIGHT BULB

CAUTION: DISCONNECT THE APPLIANCE FROM THE ELECTRICITY SUPPLY BEFORE REPLACING THE LAMP TO AVOID THE POSSIBILITY OF AN ELECTRIC SHOCK

Light bulbs are not covered by the manufacturer's guarantee.

A new 15W, 300°C rated SES bulb can be obtained from your cooker supplier or any major electrical retailer.

1. Remove the shelves from the oven.
2. Unscrew the lens using a thick cloth to protect your fingers in the unlikely event of a lens fracture.
3. Unscrew bulb.
4. Fit new bulb and refit lens.

CARE AND CLEANING

COOKER FINISH	CLEANING METHOD
<p>Vitreous Enamel Hotplate, pan supports, hotplate front trim, burner caps, roasting dish, grill pan, main oven base, inside of grill compartment, inside of doors.</p>	<p>Cloth wrung out in warm soapy water. Stubborn stains can be removed with a cream paste, liquid cleaner or by rubbing with fine steel wool soap pads. Check that the cleaning agent is approved by the Vitreous Enamel Association.</p>
<p>Paint Side trims, plinth, fascia bottom trim, fascia end caps, side panels, door handles</p>	<p>Wash with a cloth wrung out in warm soapy water only. DO NOT USE ABRASIVES.</p>
<p>Aluminium Hotplate side trims, hotplate burner bodies, lid rear trim, rear flue grille.</p>	<p>Similar to paint cleaning above. Use a nylon brush to remove any cleaning materials, water or dirt from the hotplate burner bodies.</p>
<p>Glass</p>	<p>As for enamel cleaning. Polish with a clean dry cloth or kitchen roll.</p>
<p>Chromium Plating Oven shelves, grill pan grid, grill pan handle support</p>	<p>Wipe with a cloth wrung out in warm soapy water. A fine steel wool soap pad e.g. Brillo, Ajax, or a chrome or stainless steel cleaner may be used.</p>
<p>Plastic Grill pan handle, control knobs</p>	<p>Wipe with a cloth wrung out in warm soapy water. Stubborn stains can be removed with a cream cleaner.</p>

CARE AND CLEANING

Take particular care not to damage the inner surface of the door inner glass that is coated with a heat reflective layer. Do not use scouring pads, or abrasive powder, which will scratch the glass. Ensure that the glass panel is not subjected to any sharp mechanical blows.

Stubborn stains can be removed by using a fine steel wool soap pad. For slight soiling the inner glass panel may be cleaned, while still warm, without removing it from the door. After cleaning, rinse and dry with a soft cloth.

CLEANING THE DOORS

SIDE OPENING DOORS

Cleaning the door glass is the same as the drop down doors, except take care to support the weight of the inner glass when removing and refitting.

DROP DOWN DOORS

Remove the door inner glass as follows.

1. Open the door fully and unscrew the two screws securing the glass panel so that the securing brackets can be turned. There is no need to remove the screws completely.
2. Turn the brackets so that the glass can be removed and cleaned at the sink (Fig. 1.)

Fig. 1.

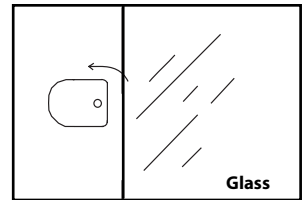

3. The inside of the outer door glass can now be cleaned while still fitted to the cooker.

NEVER OPERATE THE COOKER WITHOUT THE INNER DOOR GLASS IN POSITION.

Refit the door inner glass as follows.

1. **NOTE:** The inner door glass has a special reflective coating on one side. Replace the door inner glass so that the statement: **“IMPORTANT THIS FACE TOWARDS THE OVEN”** can be read from the inner side of the door.
2. Turn the two securing brackets back to their original position to retain the glass and tighten the screws (Fig. 2.)

Fig. 2.

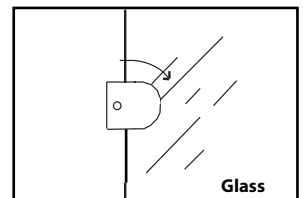

SOMETHING WRONG WITH YOUR COOKER

Before contacting your Service Centre or Installer, check the problem guide below, there may be nothing wrong with your cooker.

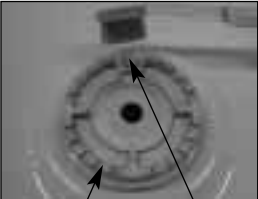
PROBLEM	CHECK
<p>Ignition does not work.</p> <p>Hotplate burner.</p>  <p>Burner ports Ignitor</p>	<p><u>If all burners fail to ignite:</u> Check that sparks appear at the burners; a clicking noise should be heard. If not...</p> <p>Check that the electricity supply is turned on. If the electricity supply has failed, the hotplate burners can be lit by a match.</p> <p><u>If only one burner fails to ignite:</u></p> <p>Check that the burner is dry and that spillage of food or cleaning fluid remains are not affecting the ignitor or burner ports. Clean away any debris with a dry nylon brush such as an old toothbrush. If a wire wool pad has been used for cleaning around the burner ensure the ignitor is free from any stray strands. Any water on the burner should be dried with a cloth or kitchen towel.</p> <p>Make sure that all the burner parts are correctly seated.</p>

SOMETHING WRONG WITH YOUR COOKER

PROBLEM	CHECK
Slight odour or small amount of smoke when grill / oven used first time	This is normal and should cease after a short period.
Oven cooks too fast or too slow	Check that the temperature and shelf positions are as recommended in the Oven Cooking Charts. However, it may be necessary to increase or decrease the recommended setting slightly to suit your taste.
Cannot set an "Auto Cook" programme or cannot get the timer to turn the oven on or off at the required times.	Read the Timer instructions in this book carefully remembering that the Cook period is the length of time that the timer will switch the oven(s) on as part of an Auto Cooking Programme.
Timer Display shows "0:00" with "Auto" Flashing.	The electricity supply to the cooker may have been interrupted, but has now come back on again. set the correct time of day by following the instructions given in the timer section of this book.
Main Oven does not work, but the grill, Top Oven and hotplate burners work.	The timer may be set for an Auto Cooking Programme. Check the timer to see if "AUTO" is illuminated. If it is, follow the instructions given in the timer section of this book to cancel the Auto Cooking Programme.
Oven lamp does not work	The oven lamp is not covered by the guarantee. The part is easily changed (see the section on oven lamp replacement). A new lamp may be obtained from our Parts department (see Key Contacts, back page).

DISPOSAL OF YOUR PRODUCT:

To minimise the risk to injury to children please dispose of your product carefully and safely. Remove all doors and lids (where fitted). Remove the mains cable (where fitted) by cutting off flush with the appliance and always ensure that no plug is left in a condition where it could be connected to the electricity supply. To help the environment, Local Authority instructions should be followed for the disposal of your product.

INSTALLATION INSTRUCTIONS

Prior to installation, ensure that the local distribution conditions (nature of the gas and gas pressure) and the adjustment conditions are compatible. The adjustment conditions for this appliance are stated on the rating label which is fitted on the back panel.

This appliance is not designed to be connected to a combustion products evacuation device. It must be installed and connected in accordance with current installation regulations. Particular attention should be given to the relevant requirements regarding ventilation.

MODEL NUMBERS EG72 and EG53

Category II_{2H3+} (GB, IE)

These models are set to burn NATURAL GAS (G20) at 20mbar but can be converted for use on BUTANE (G30) at 28-30mbar or PROPANE (G31) at 37mbar with the use of a service kit available from our service and spares department (see rear page).

GAS SAFETY (INSTALLATION & USE) REGULATIONS

It is the law that all gas appliances are installed by competent persons in accordance with the current edition of the above regulations. It is in your interest and that of safety to ensure compliance with the law.

In the UK, CORGI registered installers work to safe standards of practice.

The cooker must also be installed in accordance with BS 6172.

Failure to install the cooker correctly could invalidate the warranty liability claims and could lead to prosecution.

LOCATION

The cooker may be located in a kitchen, kitchen/diner or a bed-sitting room, but not in a room containing a bath or shower. The cooker must not be installed in a bed-sitting room of less than 20m³.

When adjusted for use on BUTANE (G30) or PROPANE (G31) the cooker must not be installed in a room or internal space below ground level, e.g. in a basement.

PROVISION FOR VENTILATION

The room containing the cooker should have an air supply in accordance with BS 5440: Part 2.

The room must have an opening window or equivalent; some rooms may also require a permanent vent. If the room has a volume between 5 and 10m³, it will require an air vent of 50cm² effective area unless it has a door which opens directly to outside. If the room has a volume of less than 5m³, it will require an air vent of 100cm² effective area. If there are other fuel burning appliances in the same room, BS 5440: Part 2 should be consulted to determine air vent requirements.

INSTALLATION INSTRUCTIONS

TECHNICAL DATA

DIMENSIONS

Height	900 - 915mm
Width	600mm
Depth	595mm (excluding door handles)

GENERAL

Gas connection	Rp 1/2 (1/2" BSP female)
Pressure test point	Hotplate burner injector.
Gas rate adjustment	None
Aeration adjustment	None
Electrical connection	4mm ² twin and earth. 230-240V a.c. 50Hz.

	Natural Gas		LPG	
	Heat Input	Injector	Heat Input	Injector
HOTPLATE Front left and rear right	3.0kW	128	2.8kW (205g/h)	82
HOTPLATE Front right and rear left	1.9kW	102	1.8kW (130g/h)	65
GRILL	2.4 / 2.6kW			
TOP OVEN	1.7 / 1.85kW			
MAIN OVEN	2.3 / 2.5kW			

INSTALLATION INSTRUCTIONS

SPACE FOR FIXING

The cooker can be close fitted below hotplate level. This requires a minimum distance of 600mm between cupboard units of hotplate height.

When installing next to a tall cupboard, partition or wall, for a minimum distance of 400mm above hotplate level, allow a side clearance of at least 65mm.

The diagram below illustrates the minimum clearance between the cooker and adjacent walls, cupboards etc.

The wall behind the cooker between the hotplate and 450mm above, and the width of the cooker, must be a non-combustible material such as ceramic wall tiles.

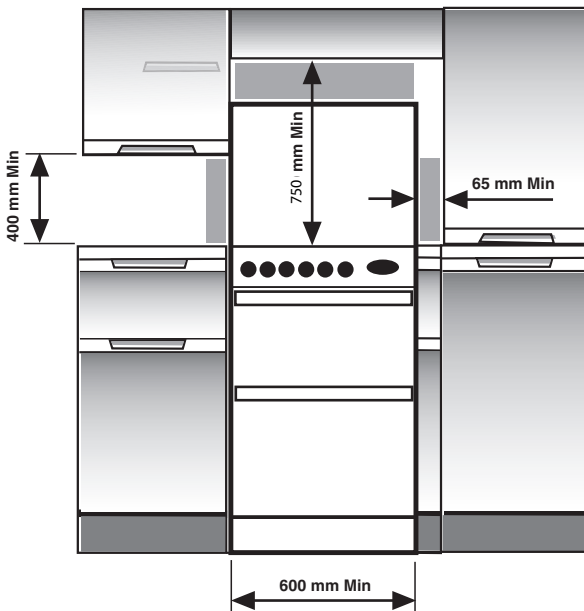

If the cooker is to be fitted close to a corner base unit on the left hand side, ensure that there is a clearance of at least 50mm to allow the oven door to open fully for when removing oven shelves.

COOKER HOODS

If a cooker hood is to be installed, refer to the cooker hood manufacturers' instructions regarding fixing height.

UNPACKING THE COOKER

Unpack the components from inside the grill and oven: Check that the following parts are present:

- | | |
|-----------------------------|-----------------------|
| Grill pan and grid | Meat pan |
| Pan supports | Main oven shelves (2) |
| Enamelled burner caps (4) | Literature |
| Aluminium burner bodies (4) | Top Oven Shelf |

INSTALLATION INSTRUCTIONS

LEVELLING

Two rear wheels and two front feet are fitted which can be adjusted up or down to set the height (915mm) and level the cooker.

1. The rear wheels can be raised or lowered from the BACK of the cooker by adjusting the levelling screws 'A' in the plinth.
2. The front feet can be simply screwed in or out to lower or raise the front of the cooker.

CAUTION: Some soft floor coverings may get damaged if the cooker is not moved carefully.

NOTE: Ensure oven shelves are level by using a spirit level on the rod shelves



VIEWED FROM REAR

STABILITY BRACKET

The back of the cooker has a slot for engagement of a stability bracket, which can be obtained, as an extra, from your cooker supplier.

CONNECTING TO GAS SUPPLY

The cooker is designed to match the depth of standard 600mm worktops. An adaptor backplate should, therefore, be fitted within the shaded area shown to allow the cooker to be pushed fully to the wall.

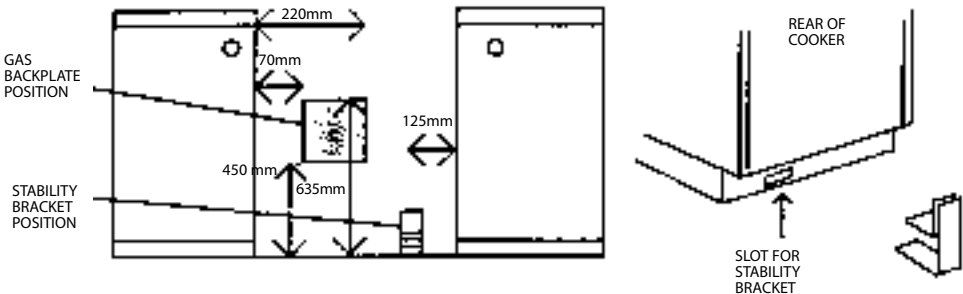

Connection to the cooker should be made with an approved appliance flexible connection to BS 669. Hoses connected to LPG should be suitable for LPG and capable of withstanding 50mbar pressure. A length of 0.9 to 1.25m is recommended. The length of hose chosen should be such that when the cooker is in situ, the hose does not touch the floor.

The temperature rise of areas at the rear of the cooker that are likely to come in contact with the flexible hose do not exceed 70°C.

ELECTRICAL INSTALLATION

WARNING - THIS APPLIANCE MUST BE EARTHED

The cooker must be connected by a qualified electrician to a suitable double - pole control unit with a minimum rating of 32A and a minimum contact clearance of 3mm, which should be fitted adjacent to (but not above) the cooker, in accordance with IEE regulations.

The power supply cable should conform to BS6004 with a conductor size of 4mm².

The control unit should be easily accessible in the event of an emergency.

This appliance conforms to EN55014 regarding suppression of radio and television interference.

Access to the mains terminals is gained by removing the rear access cover.

The mains cable must pass through the cable clamp adjacent to the terminal block, and the screws must be fully tightened. Sufficient cable should be used to allow the cooker to be pulled out for servicing.

Take care not to trap the mains cable when pushing the cooker into its final position.

OPERATIONAL CHECKS

After installation, check for gas soundness. The supply pressure can be checked at one of the hotplate burner injectors.

Check that the hotplate burners ignite correctly and burn with a steady flame. Check for a steady flame at the low setting.

Instruct the user on the operation of the cooker.

Key Contacts

Service

Hotpoint has the largest appliance manufacturer's service team in Europe, trained specialists directly employed by us to ensure your complete confidence.

Repair Service

UK: 08709 066 066

Republic of Ireland: 1850 302 200

You will be asked for the following information:-

Name, address and postcode.

Telephone number

Model / Serial number of the appliance

Clear and concise details of the query or fault

Place and Date of purchase

(Please keep the receipt as evidence will be required when the engineer calls).

Extended Warranty

To join: UK 08709 088 088

Republic of Ireland: 1850 502 200

Genuine Parts & Accessories Mail Order Hotline

UK: 08709 077 077

Republic of Ireland: (01) 842 6836

For further product information 08701 506070

All Hotpoint Services are offered as an extra benefit and do not affect your statutory rights.



Merloni Elettrodomestici UK Ltd, Morley Way, Peterborough, PE2 9JB

Free Manuals Download Website

<http://myh66.com>

<http://usermanuals.us>

<http://www.somanuals.com>

<http://www.4manuals.cc>

<http://www.manual-lib.com>

<http://www.404manual.com>

<http://www.luxmanual.com>

<http://aubethermostatmanual.com>

Golf course search by state

<http://golfingnear.com>

Email search by domain

<http://emailbydomain.com>

Auto manuals search

<http://auto.somanuals.com>

TV manuals search

<http://tv.somanuals.com>