



Instructions for Installation and Use

50cm Free Standing Electric Cooker

EW48G
EW48K
EW48P
EW48X

To the Installer

Before installation fill in the product details on the back cover this book.
The information can be found on the rating plate.

To the User

You must read the instructions prior to installing and using the appliance and
then retain them for future reference.

Contents

Introduction	3
Installation	4
Safety Information	6
Features	8
Control Panel	9
Ceramic hob	10
Use of hotplates	10
Hotplates General Information Notes	11
Choosing Your Utensils	14
Grilling	15
Top Oven - Conventional Cooking	16
Oven Temperature Charts - Baking	17
Oven Temperature Charts - Meat	18
Main Oven - Fan Cooking	19
Using the Main Oven for Other Functions	20
Care and Cleaning	21
Cooking Results Not Satisfactory?	23
Something Wrong With Your Cooker?	24
Electronic timer	25
Technical Characteristics	26
After Sales Service	30
Hotpoint Guarantee	31
Key Contacts	Back Cover

You must read these instructions prior to using your appliance and retain them for future use.

Introduction

Your new appliance is guaranteed* and will give lasting service. This guarantee is only applicable if the appliance has been installed in accordance with the installation instructions detailed in this booklet.

To help make best use of your cooking equipment, please read this booklet carefully.

The cooker is designed specifically for domestic use and responsibility will not be accepted for use in any other installation.

**When the cooker is first used an odour may be emitted,
this will cease after a period of use.**

When first using the cooker ensure that the room is well ventilated (e.g. open a window or use an extractor fan) and that persons who may be sensitive to the odour avoid any fumes. It is suggested that any pets be removed from the room until the smell has ceased. This odour is due to temporary finish on oven liners and elements and also any moisture absorbed by the insulation.

*** The guarantee is subject to the provisions that the appliance:**

- (a) Has been used solely in accordance with the Users Instruction Book.**
- (b) Has been properly connected to a suitable supply voltage as stated on the rating plate attached to this equipment.**
- (c) Has not been subjected to misuse or accident or been modified or repaired by any person other than the authorised employee or agent.**
- (d) Has been correctly installed.**

Installation

WARNING – THIS APPLIANCE MUST BE EARTHED.

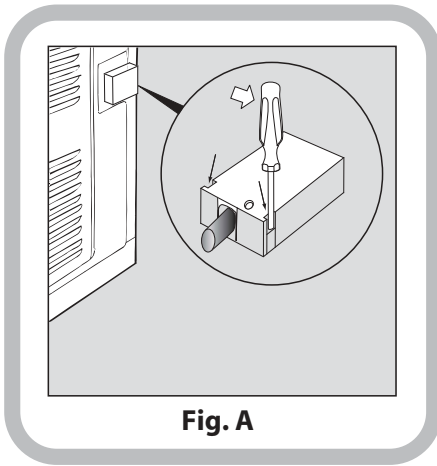

Fig. A

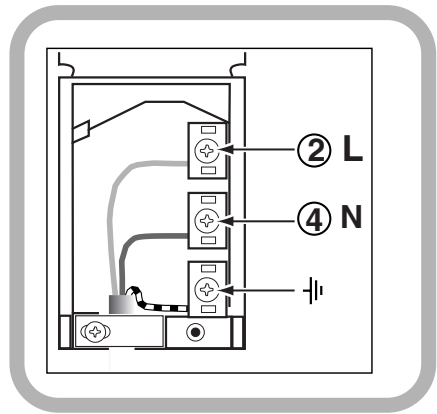

Fig. B

Electrical connection

Electric cookers come without a power supply cable. The cooker is designed to operate on an electricity supply which conforms to the electrical data shown on the Rating Plate. The cooker can be connected to the mains only after removing the back panel of the cooker itself with a screwdriver.

N.B.: the following installation procedure must be carried out by a qualified electrician. The electrical installation must comply with the IEE Regulations, Building & local By-Lays.

For the installation of the feeding cable carry out the following operations:

- Using a screwdriver, prise on the side tabs of the terminal board cover (see fig. A);
- Pull and open the junction blok lid

Important: the wires in the mains lead are coloured in accordance with the following code:

Green & Yellow **Earth**
Blue **Neutral**
Brown **Live**

As the colours of the wires in the mains lead may not correspond with the coloured markings identifying the terminals in your plug, proceed as follows: Green & Yellow wire to terminal marked "E" or  or coloured Green or Green & Yellow.

Brown wire to terminal marked "L" or coloured Red.

Blue wire to terminal marked "N" or coloured Black (see fig. B).

- fix the feeding cable in the special cable stop and close the cover.

N.B.: the power supply cable must have these minimum requirements:

Type: H05RR-F
Section: 3x4 mm²

Ensure that the mains cable is routed away from any brackets affixed to the rear panel and is not trapped to the rear wall when pushing the cooker into position between cabinets.

Installation

Siting the Cooker

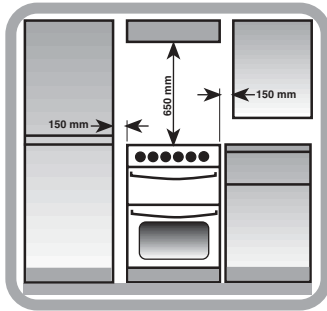

The height of the cooker can be adjusted by means of adjustable feet in the plinth (900mm - 930mm). Adjust the feet by tilting the cooker from the side. Then install the product into position.

NOTE: This appliance must not be fitted on a platform.

The cooker is designed to fit between kitchen cabinets spaced 500mm apart. The space either side need only be sufficient to allow withdrawal of the cooker for servicing. It can be used with cabinets one side or both as well as in a corner setting. It can also be used free-standing.

Adjacent side walls which project above hob level, must not be nearer to the cooker than 150mm and should be protected by heat resistant material. Any overhanging surface or cooker hood should not be nearer than 650mm.

Moving the Cooker

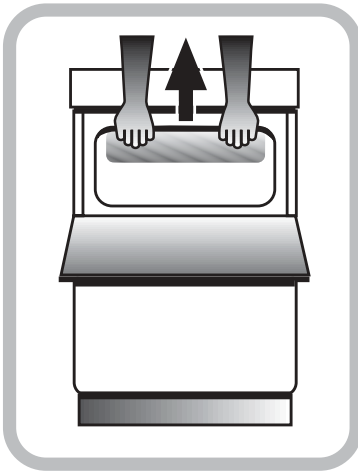

Before moving your cooker check that it is cool, and switch off at the cooker control unit.

Movement of your cooker is most easily achieved by lifting the front as follows: Open the grill door sufficiently to allow a comfortable grip on the underside front edge of the oven roof, avoiding any grill elements.

Note: Take care in moving the cooker as it is heavy. Take care to ensure that any floor covering is not damaged.

Safety Information

When used properly your appliance is completely safe but as with any electrical product there are certain precautions that must be observed.

PLEASE READ THE PRECAUTIONS BELOW BEFORE USING YOUR APPLIANCE.

Always

- Remove all packing from inside the oven and grill compartments before switching on for the first time.
- Understand the controls prior to using the appliance.
- Keep children away from the appliance when grilling as the surfaces will get extremely hot during and after use.
- Turn controls **off** when you have finished cooking and when not in use.
- Stand back when opening an oven door to allow any build up of steam or heat to disperse.
- Use dry good quality oven gloves when removing items from the oven/grill.
- Place pans centrally over the hotplate making sure handles are kept away from the edge of the hob and cannot become heated by other hotplate/pans.
- Take care to avoid heat/steam burns when operating the controls.
- Turn off the electricity supply at the wall switch before cleaning and allow the appliance to cool.
- Make sure the shelves are in the correct position before switching on the oven.
- Keep the oven and grill doors closed when the appliance is not in use.
- Take care when removing items from the grill when the lower oven is on as the contents will be hot.
- Keep the appliance clean, as a build up of grease or fat from cooking can cause a fire.
- Follow the basic principles of food handling and hygiene to prevent the possibility of bacterial growth.
- Keep ventilation slots clear of obstructions.
- Refer servicing to a qualified appliance service engineer.
- Take care to avoid touching heating elements inside the oven, as during use the oven becomes hot.
- Before operating the product, remove all plastic film from the sides of the appliance.

Safety Information

Never

- Never line the interior of the oven with foil as this may cause the appliance to overheat.
- Never leave children unsupervised where a cooking appliance is installed as all surfaces will be hot during and after its use.
- Never allow anyone to sit or stand on any part of the appliance.
- Never store items above the appliance that children may attempt to reach.
- Never leave anything on the hob surface when unattended and not in use.
- Never remove the oven shelves whilst the oven is hot.
- Never heat up unopened food containers as pressure can build up causing the container to burst.
- Never store chemicals/food stuffs, pressurised container in or on the appliance, or in cabinets immediately above or next to the appliance.
- Never place flammable or plastic items on or near the hob.
- Never fill a deep fat frying pan more than 1/3 full of oil, or use a lid.
DO NOT LEAVE UNATTENDED WHILE COOKING.
- Never operate the grill with the grill door closed as this will cause the appliance to overheat.
- Never use the appliance as a room heater.
- Never use the grill to warm plates.
- Never dry any items on either the hob or oven doors.
- Never install the appliance next to curtains or other soft furnishings.
- Never use steam cleaners.

SAFETY ADVICE IN CASE OF A CHIP-PAN FIRE

In the event of a chip pan fire or any other pan fire.

1. TURN OFF THE COOKER APPLIANCE AT THE WALL SWITCH.
2. COVER THE PAN WITH A FIRE BLANKET OR DAMP CLOTH, this will smother the flames and extinguish the fire.
3. LEAVE THE PAN TO COOL FOR AT LEAST 60 MINUTES BEFORE MOVING IT. Injuries are often caused by picking up a hot pan and rushing outside with it.

NEVER USE A FIRE EXTINGUISHER TO PUT OUT A PAN FIRE as the force of the extinguisher is likely to tip the pan over.

Never use water to extinguish oil or fat fires.

Features

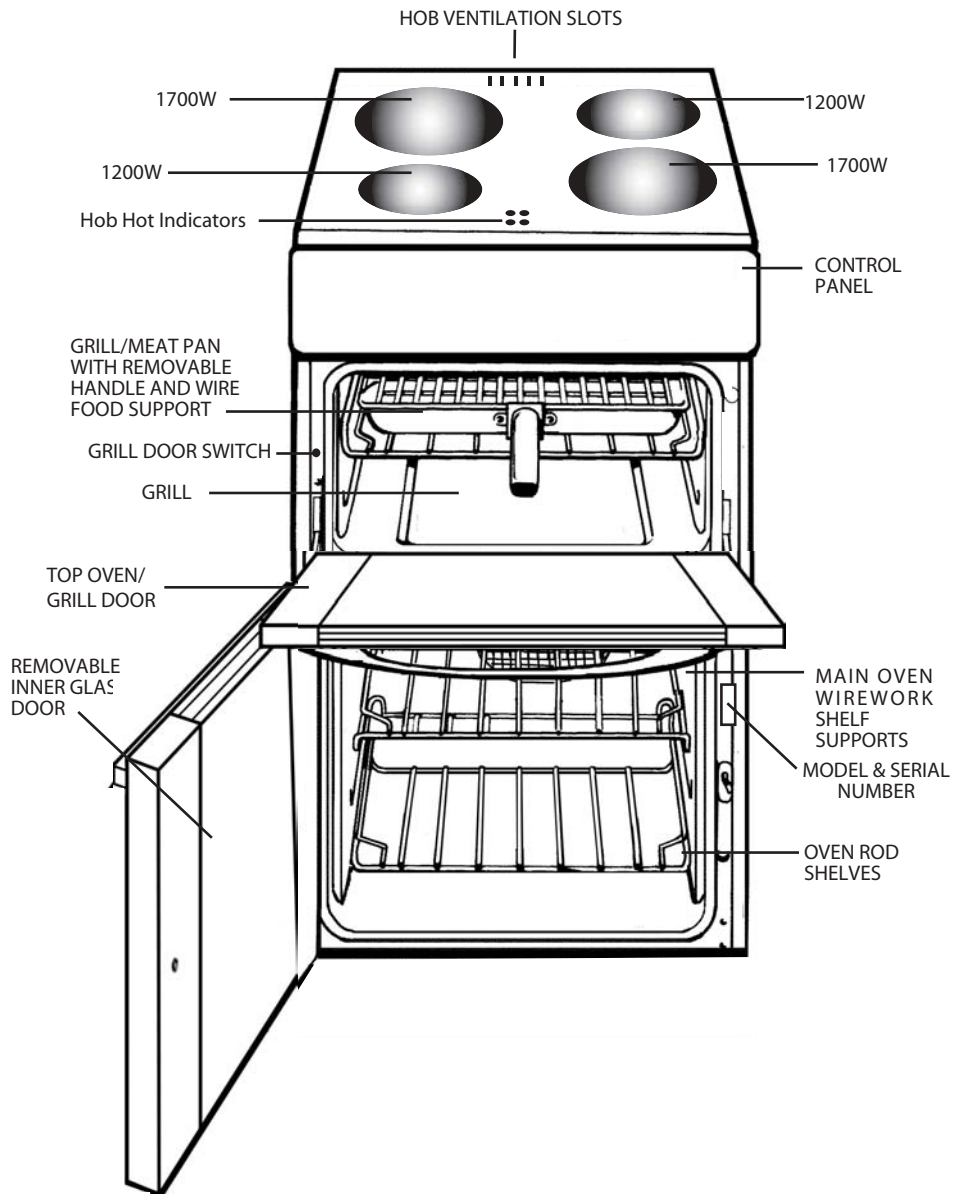

Control Panel

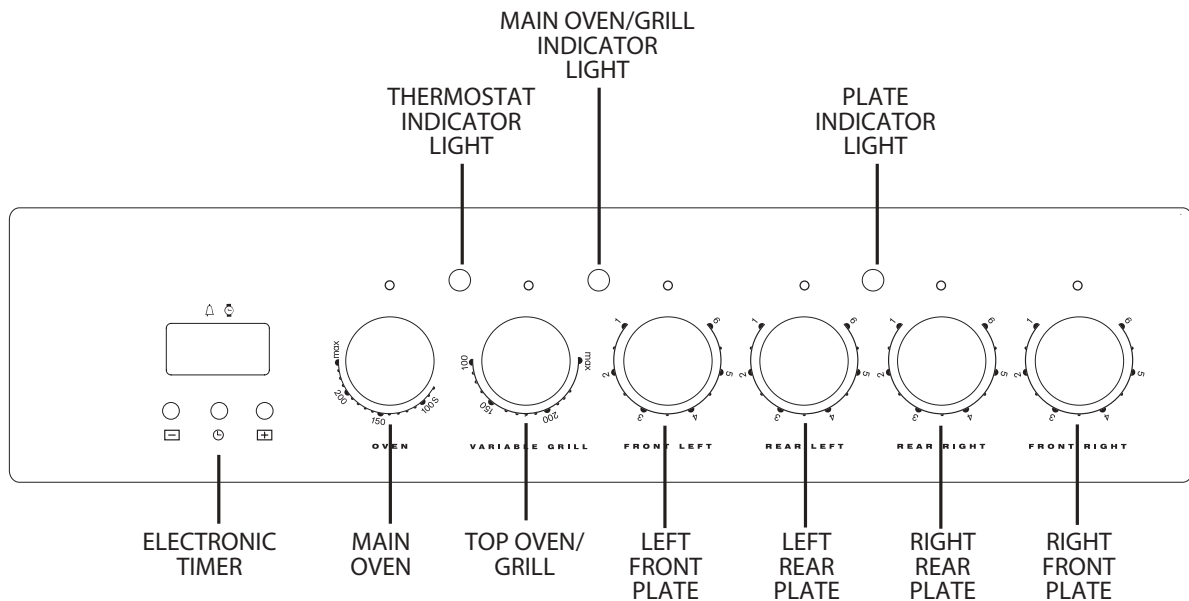

Control Knobs

The knobs for the hotplates can be rotated in either direction to provide variable heat control, the Main Oven knob can only be rotated clockwise from the **Off** position.

Note: Always ensure that all controls are in the OFF position, when the appliance is not in use.

The hob hot warning lights will operate soon after each of the heating areas have been switched on. Each warning light will remain illuminated until each heating area has cooled down.

Operating the control when the grill is in use

In common with all cookers having controls sited above the grill compartment, care must be taken when setting the controls, due to hot air being emitted from the grill compartment.

Top oven control

This control switches on the top and bottom heating elements in the top oven. The temperature in the oven can be set anywhere between 100 °C and 220 °C. The thermostat light will glow initially and remain on until the oven reaches the required temperature. It will then cycle off and on, as the oven thermostat maintains the correct temperature. The off position is identified by an "0".

Main oven control

This control switches on the main oven. To select Fan Cooking - Turn the control clockwise and select any temperature between 80 °C and 230 °C. As the control is turned the fan will start, the oven interior light and the main oven thermostat light will come on and the heating element around the fan will start heating. The fan and the oven interior light will remain on throughout cooking. The main oven thermostat light will come on until the oven reaches the required temperature. It will then cycle off and on as the oven thermostat maintains the correct temperature.

Slow cooking 'S'

The main oven has a 'S' setting specially designed to reduce energy usage. Full details of this can be found in the Slow cooking section of this book.

Electronic timer

The electronic timer displays the time and the timer function with countdown.

Ceramic Hob

CAUTION: IF AT ANY TIME A CRACK IN THE SURFACE BECOMES VISIBLE, DISCONNECT THE APPLIANCE IMMEDIATELY FROM THE SUPPLY.

Under no circumstances should the hob be used with aluminium foil in contact with the hob surface as damage can occur.

The following boiling plates are located beneath the decorative circular patterned cooking areas:-

Front left 6 heat: 1200W
Rear left 6 heat: 1700W
Rear right 6 heat: 1200W
Front right 6 heat: 1700W

The cooking areas change colour when heated (become red) indicating which heating element is switched on. The cooking area returns to its original colour when the heating element is switched **Off**.

Warning: Even though the cooking area has returned to its original colour it may still be hot.

The controls for the hotplates can be turned in either direction.

Turn the control to 6 for fast cooking. To reduce the heat to cook more slowly or simmer, turn the control to a lower setting according to the size of the saucepan and the amount of liquid.

Pans can be placed on the unheated areas of the panel when cooking is finished and before serving food. It is inadvisable at any time to leave a heating element switched on without a pan in position as this wastes energy, and could make soil or rub-off from aluminium pans more difficult to remove. To protect elements against over-heating, safety cut-outs have been incorporated with each element. After several minutes with the control at setting 6 the safety cut-out switches the element **Off** and **On** continuously, thus preventing any adverse effects that may be caused by an excessive build-up of heat in the cooking area.

Use of Hotplates

Note: Under no circumstances should the hob be used with aluminium foil in contact with the hob surface.

Turn the control to 6 for fast cooking. To cook more slowly or simmer, turn the control to a lower setting according to the size of the saucepan and the amount of liquid. The two small Hotplates are specially for smaller pans, low temperature cooking and simmering.

Do Not leave a hotplate switched on without a pan as this wastes energy and may shorten the life of the hotplate.

Hotplates General Information Notes

CONTROL SETTINGS GUIDE

This is provided only as a guide – settings also depend on the type of pan used and the quality of food.

Knob Position	Type of food
1	To melt butter, chocolate, etc.
1 or 2	To heat food gently. To keep small amounts of water simmering. To heat sauces, containing egg yolks and butter. To simmer: stews, meat, fish, vegetables, fruit.
3	To heat solid and liquid foods. Keep water boiling. Thaw frozen vegetables. Make 2-3 egg omelettes.
4 or 5	To cook foods, just above simmering. To maintain 'rolling' boil for preserve making.
5 or 6	To seal meat and fry fish.
6	Frying potatoes. Bringing water to the boil. Deep fat frying. Dissolve sugar for preserve making.

Safety requirements for deep fat frying

1. Use a deep pan, large enough to completely cover the appropriate heating area.
2. Never fill the pan more than one-third full of oil.
3. Never leave oil or fat unattended during the heating or cooking period.
4. Never try to fry too much food at a time, especially frozen food. This only lowers the temperature of the oil or fat too much, resulting in greasy food.
5. Always dry food thoroughly before frying, and lower it slowly into the hot oil or fat. Frozen foods, in particular, will cause frothing and spitting, if added to quickly.
6. Never heat fat, or fry, with a lid on the pan.
7. Keep the outside of the pan clean and free from streaks of oil or fat.

Hotplates General Information Notes

PANS SHOULD



Not be concave (bowed in)



Not be convex (bowed out)



Not be rimmed



Not be deeply ridged



But essentially Flat

✓ suitable X unsuitable
*care should be taken
when using any pans
on these surfaces not to
drag and cause
scratching.

Always ✓	Never X
<ul style="list-style-type: none"> Use good quality flat-based cookware on all electric heat sources. 	<ul style="list-style-type: none"> Use gauze, metal pan diffusers, asbestos mats and stands e.g. Wok stands - they can use overheating.
<ul style="list-style-type: none"> Always ensure pans have clean, dry bases before use. 	<ul style="list-style-type: none"> Use utensils with skirts or rims e.g. buckets and some kettles.
<ul style="list-style-type: none"> Ensure pans match size of heating area. 	<ul style="list-style-type: none"> Use badly dented or distorted pans.
<ul style="list-style-type: none"> Remember good quality pans retain heat well, so generally only a low or medium heat is necessary. 	<ul style="list-style-type: none"> Leave an element switched on when not cooking.
<ul style="list-style-type: none"> Ensure pan handles are positioned safely and away from heat sources. 	<ul style="list-style-type: none"> Cook food directly on the ceramic glass.
<ul style="list-style-type: none"> Always lift pans, do not drag. 	<ul style="list-style-type: none"> Drag or slide utensils, along the hob surface.
<ul style="list-style-type: none"> Always use pan lids except when frying. 	
<ul style="list-style-type: none"> Deal with spillages immediately but with care. 	

THE BEST COMBINATIONS

This table is a general guide to the types of pan suitable for different types of hobs and cookers. Remember pans should be good quality, with smooth, flat bases. For any further information refer to manufacturers' instructions.

	Ceramic*
Aluminium	✓
Stainless steel with single layer copper base	X
Stainless steel with sandwich bases of aluminium and stainless or aluminium and copper	✓
Enamelled steel	✓
Enamelled aluminium	✓
Enamelled based cast iron	✓ With Extra Care
Copper	X
Toughened glass or ceramic / glass / pottery	Not Recommended
Mild steel, Ferro-magnetic or stainless with a magnetic sandwich base	✓

Hotplates General Information Notes

Do Not

- Do not** cook directly on the hob surface without a cooking utensil, as this will result in damage to the surface of the hob.
- Do not** use the hob as a worktop surface as damage may occur to the smooth surface of the hob.
- Do not** drag or slide utensils on the hob surface, as this will cause scratches in the surface of the hob.
- Do not** allow a cooking utensil to come into contact with the hob surround.
- Do not** place anything between the base of the utensil and the ceramic hob, e.g. do not use asbestos mats, aluminium or wok stand.

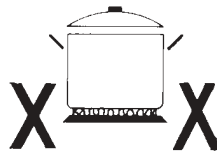

- Do not** leave any utensils, food or combustible items on the hob when it is not in use.
- Do not** place aluminium or plastic foil, or plastic containers on the hob.
- Do not** leave the hotplates or cooking areas switched **On** unless they are being used. We recommend not to place large preserving pans or fish kettles across two heating areas.
- Do not** leave utensils partly covering the heated areas. Always ensure that they are placed centrally over the heated areas and have the same diameter as the heating area used.



We recommend not to use a utensil with a base diameter greater than 25cm (10ins).

Pressure cookers or other large pans should be used on the front cooking areas.

Always ensure that saucepan handles are positioned safely.

Choosing Your Utensils

- Do not** use utensils with rough bases.
- Do not** use lightweight utensils with thin, distorted or uneven bases.
- Do not** use lightweight enamelled steel utensils.
- Do not** use cast iron utensils.
- Do not** use utensils with recessed, scrolled or ridged bases.
- Do not** use a utensil which has a base concavity greater than 1 mm as this will reduce the performance of the hob.
- Do not** use a utensil with a convex base.
- Do not** use glass ceramic utensils.
- Do not** use use lightweight saucepans with plain thin copper bases on ceramic or halogen hot plates.

Note: All copper pans are excellent conductors of heat, and are hard wearing and strong, but need quite a lot of care. They can be very heavy and do not usually have completely flat bases. The interiors are usually lined with a different material such as tin.

A stainless steel pan with a sandwich base of aluminium and stainless steel is an excellent conductor of heat and is suitable for use on ceramic and halogen hobs, providing they are used in accordance with the saucepans manufacturers' recommendations.

Stainless steel pans with a sandwich base of aluminium and copper are excellent conductors of heat. If using stainless steel saucepans with aluminium and copper sandwich bases on ceramic and halogen hobs, the use of these pans must be in accordance with the saucepan manufacturers' recommendations.

Extra care should be taken to ensure the base of the pan and the hob is cleaned, and the hob conditioned, after each and every use, when using this type of saucepan.

If these recommendations are not followed, the result will be a build up of small copper deposits on the surface of your hob which, if not cleaned after each use, will result in permanent marking of your hob.

Always lift the pan from the hob, **do not** drag or slide across the hob surface as damage may occur.

Grilling

A switch operated by the door changes the heating element configuration between grill and oven operation. When the door is open, the top inner element is activated for intense downward heat; when the door is closed, the top outer and lower elements are activated to provide even oven heating.

To operate the grill proceed as follows:

- Open the grill door.
- Pre-heat the grill on setting MAX for approximately 5 minutes (see chart on guide to grilling).

Grill Pan Handle

- Fix the grill pan handle securely in position. See below.
- Food which only requires browning should be placed directly on/in the grill pan in the grill pan runner, or on the floor of the grill compartment. (the grill pan grid may be removed.)
- Leave the control on setting 6 for toast, sealing and fast cooking of foods. For thicker foods requiring longer cooking turn the control to a lower setting after the initial sealing, on both sides, on setting 6. The thicker the food the lower the control should be set.

Warning: Take care as the grill will be hot – always wear oven gloves. Always ensure that the grill pan is clean BEFORE use. Excess fat build up in the bottom of the pan could cause a fire hazard. Never line grill pan with foil.

Fixing the Grill Pan Handle

The grill pan handle is detachable from the pan, to facilitate cleaning and storage. Fix the grill pan handle securely in position before use.

The handle fits onto the grill pan edge with the small recess, Fig.1.

Tilt the handle over the recess and slide it towards the centre, Fig.2.

Ensure the handle is fully located. Insert the washer and fixing screw and tighten fully to ensure handle is secured, Fig.3.

Always hold the dripping pan handle in the highlighted zone marked "OK" in figure 4.

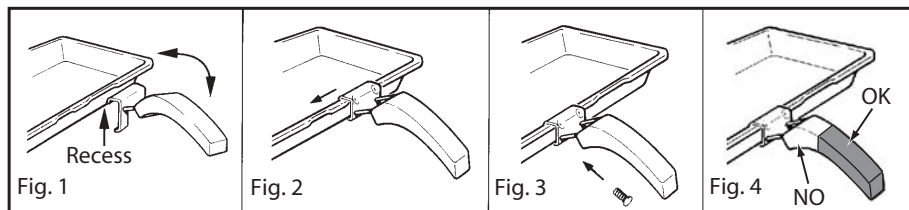

Always fit the screw prior to use.

The food to be cooked should be placed on the grill pan/grill pan food support.

Place the grill pan on the runners and push back to the stop position when the grill pan is correctly positioned beneath the grill element.

Plates and dishes placed on the floor of the grill compartment will be heated when the oven is in use.

Grill Compartment as a 'Hotcupboard'

Do not operate the grill control when using the compartment as a hotcupboard.

Do take care when removing plates, dishes and utensils from the grill compartment when the oven is in use as they may become quite hot.

You may need to use oven gloves when removing warmed items.

Top Oven - Conventional Cooking

The heat for conventional cooking in the top oven is provided by the grill element and the element under the floor of the oven. It is ideal for the slow cooking of cheaper cuts of meat in casseroles etc. but can also be used for small joints of meat up to 1.5kg (3lb).

See cooking charts for temperatures and shelf positioning.

The top oven can be used either independently to cook small quantities of food or in conjunction with the main oven to provide additional cooking space.

- The shelf should be positioned on the first or second runner from the bottom.

To use the oven proceed as follows:

- Set the top oven control to the required temperature, the top oven light will come on and wait for the thermostat light to go off, indicating that the oven has reached the right temperature.
- The food to be cooked should be placed in the centre of the shelf with a gap of at least 25mm (1in) between it and the grill element. This should avoid burning and ensure even cooking.
- **Do not place food or dishes on the floor of the oven.**

Platwarming in the top oven

Plates and dishes placed on the floor of the top oven will be heated when the main oven is in use. When the main oven is not in use, for instance when a meal is being cooked on the hob, place the plates and serving dishes on the shelf using the bottom runner and turn the top oven control to approximately 100 °C. A maximum time of 10-12 minutes is all that is required to heat the plates and dishes.

NEVER operate the grill control when using the top oven for cooking or warming plates and dishes.

WARNING: DO NOT put delicate items china or items which could be affected by heat into the oven.

Oven Temperature Charts - Baking

Baking	Top Oven Cooking				Fan Oven Cooking		
	Pre-heat	Temperature C	Time in mins.	Position in Oven	Pre-heat	Temperature C	Time in mins.
Food							
Scones	Yes	210/220	10-15	Runner 2 from bottom of oven.	Yes	210/220	9-12
Small Cakes	Yes	180/190	20-25	Runner 2 from bottom of oven.		170/180	15-25
Victoria Sandwich	Yes	170/180	20-30	Runner 2 from bottom of oven.		160/170	20-25
Sponge Sandwich (fatless)	Yes	180/190	20-25	Runner 2 from bottom of oven.	Yes	170/190	15-20
Swiss Roll	Yes	200/210	10-15	Runner 2 from bottom of oven.	Yes	190/200	12-15
Semi-rich Fruit cakes	Yes	150/160	60-75 7 inch	Runner 1 or 2 from bottom of oven		140/150	60-75 7 inch
Rich Fruit Cakes	Yes	140/150	Time Dependent on size	Runner 1 or 2 from bottom of oven		130/140	Depending on size
Shortcrust Pastry	Yes	190/200	Time Dependent on recipe	Runner 1 from bottom of oven.		190/200	Dependent on use
Puff Pastry	Yes	200/210	Time Dependent on recipe	Runner 1 from bottom of oven.		190/200	Dependent on use
Yorkshire Pudding	Yes	190/200	30-40	Runner 2 from bottom of oven.	Yes	180/190	30-45
Individual Yorkshire Puddings	Yes	200/210	20-30	Runner 2 from bottom of oven.	Yes	190/200	20-25
Milk Pudding	Yes	140/150	90-120	Runner 1 from bottom of oven.		130/140	105-135
Baked Custard	Yes	150/160	40-50	Runner 1 from bottom of oven.		140/150	40-50
Bread	Yes	200/210	30-45	Runner 1 from bottom of oven.	Yes	200/210	45-50
Meringues	Yes	100	150-180	Runner 2 from bottom of oven.		80-90	180-240

Note: If soft margarine is used for cake making, temperatures recommended by the manufacturers should be followed. Temperatures recommended in this chart refer to cakes made with block margarine only.

Oven Temperature Charts - Meat

			Top Oven Cooking			Fan Oven Cooking		
Meat	Pre-heat	Temperature C	Time (approx.)	Position in Oven	Meat	Pre-heat	Temperature C	Time (approx.)
Beef/ Lamb (slow roasting)	Yes	170/180	35 mins per 450g (1lb) + 35 mins over.	Runner 1 from bottom of oven.	Beef	No	160/180	20-25 mins per 450g (1lb) + 20 mins extra
Beef/ Lamb (foil covered)	Yes	190/200	35-40 mins per 450g (1lb)		Lamb	No	160/180	20-30 mins per 450g (1lb) + 25 mins extra
Pork (slow roasting)	Yes	170/180	40 mins per 450g (1lb) + 40 mins over		Pork	No	160/180	25-30 mins per 450g (1lb) + 25 mins extra
Pork (foil covered)	Yes	190/200	40 mins per 450g (1lb)		Veal	No	160/170	25-30 mins per 450g (1lb) + 25 mins extra
Veal (slow roasting)	Yes	170/180	40-45 mins per 450g (1lb) + 40 mins over		Chicken/ Turkey up to 4kg (8lb)	No	160/180	18-20 mins per 450g (1lb) + 20 mins extra
Veal (foil covered)	Yes	190/200	40-45 mins per 450g (1lb)		Turkey 4 to 5.5kg (8 to 12lb)	No		13-15 mins per 450g (1lb) at 150/160°C allow 12 mins per 450g at 150°C
Poultry/Game (slow roasting)	Yes	170/180	25-30 mins per 450g (1lb) + 25 mins over		Casserole	No	140-150	1 1/2 - 2 Hrs
Poultry/Game (foil covered)	Yes	190/200	25-30 mins per 450g (1lb)					
Casserole	Yes	150	2-2 1/2 hrs					

If using aluminium foil, never: 1. Allow foil to touch sides of oven. 2. Cover oven interior with foil. 3. Cover shelves with foil.

The most accurate method of testing the readiness of joints of meat or whole poultry is to insert a meat thermometer into the thickest part of a joint, or the thickest part of poultry thighs, during the cooking period. The meat thermometer will indicate when the required internal temp has been reached.

Beef - Rare: 60 C Lamb: 80 C Poultry: 90 C
 Medium: 70 C Pork: 90 C
 Well Done: 75 C Veal: 75 C

Main Oven - Fan Cooking

This control switches on the main oven. To select Fan Cooking - Turn the control clockwise and select any temperature between 100°C and Max. As the control is turned the fan will start. The main oven light will immediately come on.

The thermostat light indicates that the main oven is heating. When it turns off, the temperature inside the oven has reached the setting made with the thermostat knob. At this point, the light will turn on and off as the oven maintains the temperature at a constant level.

The fan and the oven interior light will remain on throughout cooking. The main oven thermostat light will come on until the oven reaches the required temperature. It will then cycle off and on as the oven thermostat maintains the correct temperature.

The heat for fan cooking in the main oven is provided by an element situated at the back of the oven, around the fan.

Fan cooking is ideal for large poultry or joints of meat, reducing cooking times and often eliminating the need for pre-heating the oven. It is also ideal for batch cooking where food is cooked on more than one level, because the forced circulation of hot air gives an even temperature from the top to the bottom of the oven.

To use the oven

- proceed as follows:**
- The shelves should be evenly spaced. To avoid unnecessary cleaning, shelves which are not in use should be removed from the oven.
 - Set the main oven control to the required temperature. Pre-heating is not normally necessary, but some foods such as bread, scones and Yorkshire pudding do benefit from being placed in a hot oven (see cooking charts).
 - Place the food to be cooked in the centre of each shelf to allow for even air circulation around the food.

Using the Main Oven for Other Functions

'S'

SLOW Setting

This is used for slow cooking, keeping food warm and warming plates for short periods. Extra care should be taken when warming bone china, as it may be damaged in a hot oven.

DO NOT place food or plates directly on the oven floor as this could damage both the oven lining and the plates which are being warmed.

Advantages of "SLOW" cooking are:

The oven stays cleaner because there is less splashing.
Timing of food is not as critical, so there is less fear of overcooking.
Inexpensive joints of meat are tenderised.
Fully loading the oven can be economical.
Cooking times can be extended in some cases by up to 2 hours.

Operation:

1. Place the prepared food in the main oven and ensure the door is fully closed.
2. Select 'S' (Slow Cooking Temperature) by turning the Main Oven Control clockwise ensuring the oven door is fully closed.

Storage and re-heating of food:

1. If food is to be frozen or not used immediately, place it in a clean container and cool as soon as possible.
2. Always thaw frozen food completely in the refrigerator before re-heating.
3. Always reheat food thoroughly and ensure it is piping hot before serving.
4. Only re-heat food once.

Points to consider when preparing food for "SLOW" cooking:

1. Make sure that the dishes to be used will fit into the oven ensuring enough room for air to circulate.
2. All dishes cooked on the slow setting will require a minimum of 6 hours, however, **if** they are cooked for 1 -2 hours longer then deterioration in their appearance may be noticed.
3. Never cook joints of meat over 2.7kg (6 lb) or poultry over 2.0kg (4lb 8oz).
We do not recommend that joints of meat or poultry are stuffed before cooking on the slow setting.
4. To seal in the meat juices, always cook meat or poultry at 170°C for 30 minutes before wrapping in foil and placing on a rack over a tin (to allow good air circulation) before turning the control to the slow setting and cooking immediately.
5. Always ensure that joints of pork and poultry are thoroughly cooked by checking with a meat thermometer before serving.
6. Always thaw frozen foods completely before cooking. We do not recommend placing frozen food in the oven to cook.
7. Always bring soups, liquids and casseroles to the boil before placing in the oven.
8. Ensure that casserole dishes have a good seal (not airtight) and cover to the top with foil to prevent loss of moisture.
9. Ensure that fruit and vegetables are cut into even sized small pieces to cook properly.
10. Always adjust seasoning before serving.
11. If using dried red kidney beans it is important that the beans are soaked and then boiled for a minimum of 10 minutes before using in any dish to destroy any toxins.
12. When cooking fish or egg dishes it may be necessary to check during cooking to avoid overcooking.

Care and Cleaning

Ceramic hob

To reduce the amount of cleaning always ensure that the hob and cooking utensils are clean and dry before use. Regular use of cleaner conditioner is recommended for proper care and protection of the hob surface. Apply conditioner before using the hob for the first time. It contains a mild cleaning agent, so that subsequent applications may clean off soil and apply a protective film at the same time. For stubborn stains or heavy soiling use any of the following materials, and finish off with conditioner.

1. Cif, non-scratch scouring cream.
2. Liquid Gumption Kitchen Cleanser.
3. Special Powder Cleanser.

Powder Cleanser – Mineral deposits that are present in hard water, and some foods, may cause 'discolourations' that appear in the form of grey or brown stains. The stains sometimes appear to be in or under the glass surface. If there are some persistent stains after using any of the other recommended cleaning materials, powder cleanser may be applied, following the manufacturers instructions. **Do not** use abrasive cleaners or the powder cleanser on the painted metal framework.

Cleaner Conditioner – Regular use of the conditioner will make the surface easier to clean thus ensuring that years of heavy abrasive cleaning do not progressively dull the surface.

Grill

Remove the grill pan and the wire grid food support, it is best to wash these items immediately after use to prevent stains from being burnt on when used again. Wipe out the Grill compartment, use a fine steel wool soap pad to remove stubborn stains from the grill runners and the floor of the compartment. Wipe over the control panel with a damp cloth and polish with a dry cloth.

Control Panel

Do not use cream cleaners, oven cleaners or aerosols, scouring pads or abrasive powder for cleaning the plastic knobs as damage will occur.

Decorative Trims

It is advisable to clean the decorative trims regularly to prevent any build up of soiling. The recommended method of cleaning is to wipe over the trims with a soft cloth wrung out in warm water or mild non-abrasive cleaner. (If in doubt try the cleaner on a small area of trim which is not noticeable in normal use). Then, after wiping with a cloth wrung out in clear water, dry with a soft clean cloth.

Ovens

Remove the rod shelves and grill pan. Use a fine steel wool soap pad to remove stubborn stains from the rod shelves, grill pan and the floor of the oven. Clean the glass part of the oven door using a sponge and a non-abrasive cleaning product, then dry thoroughly with a soft cloth. Do not use rough abrasive material or sharp metal scrapers as these could scratch the surface and cause the glass to crack.

Oven Shelf Supports

The shelf supports are removable and dishwasher safe.

To remove hold the support at the front and pull away from the oven side, this can then be cleaned in a sink or a dishwasher. When removed it allows access to the oven side, which can be cleaned with warm soapy water.

To refit the support, insert the longer leg into the rear fixing hole and push in the front leg.

Oven Lamp Replacement

Open the oven door and remove the rod shelves. Using a suitable cloth to protect the fingers grip the light glass dome, unscrew anti-clockwise and lift. Reach into the aperture with fingers, and unscrew the lamp anticlockwise. Fit replacement lamp (25W 300°C rated SES), refit dome.

WARNING: To avoid electric shocks - please ensure that the electricity supply to the appliance is switched off and the appliance is fully cold, before removing the lamp lens.

Care and Cleaning

CLEANING THE DOORS

Take particular care not to damage the inner surface of the door inner glass that is coated with a heat reflective layer. Do not use scouring pads, or abrasive powder, which will scratch the glass. Ensure that the glass panel is not subjected to any sharp mechanical blows.

Stubborn stains can be removed by using a fine steel wool soap pad. For slight soiling the inner glass panel may be cleaned, while still warm, without removing it from the door. After cleaning, rinse and dry with a soft cloth.

SIDE OPENING DOORS

Cleaning the door glass is the same as the drop down doors, except take care to support the weight of the inner glass when removing and refitting.

DROP DOWN DOORS

Remove the door inner glass as follows.

1. Open the door fully and remove the extrusion end caps (This should be done by hand but if it proves too difficult, simply lift the inner glass to ease the end caps out of position).

NOTE: If you need to use a tool - be careful not to damage the extrusion or end cap.

2. Carefully slide the inner glass towards you and withdraw it from its locating slots. Ensure that the door is not allowed to slam shut, due to the reduction in door weight. Clean the glass as described above.

3. The inside of the outer door glass can now be cleaned while still fitted to the cooker.

NEVER OPERATE THE COOKER WITHOUT THE INNER DOOR GLASS IN POSITION.

Refit the door inner glass as follows.

1. Open the door fully.

2. Locate the inner door glass into its slots, so that the printing is readable from the face nearest the oven in the closed position and the widest black band is towards the bottom of the door. The inner door glass has a special reflective coating on one side, in order to minimise surface temperatures and energy consumption during use, it is important it is fitted correctly.

3. Carefully slide the glass into its slots as far as it will go and replace the end caps.

Cooking Results Not Satisfactory?

Problem	Check
Grilling Uneven cooking front to back	Ensure that the grill pan is positioned centrally below the grill element.
Fat splattering	Ensure that the grill is not set to too high a temperature.
Oven Baking Uneven rising of cake	Ensure that the oven shelves are level by using a spirit level on the rod shelf and adjusting, using suitable packing e.g. wood, under the feet of the appliance. This should be checked both left to right and front to back. Ensure that the food is positioned centrally in the oven.
Sinking of cakes	The following may cause cakes to sink: 1. Cooking at too high a temperature. 2. Using normal creaming method with soft margarine.
Over/Under cooking Fast/Slow cooking	Refer to the cooking times and temperatures given in the oven temperature charts, however, it may be necessary to increase or decrease temperatures by 10°C to suit personal taste. Do not use utensils greater than 2¼ ins in height.
Uneven cooking of cakes	1. Too large baking sheet used. (See 'Cookery Notes') 2. Over loading of oven and always ensure even air gaps around baking tins.
Uneven rising of cake	Ensure that the shelf is level (see above) and that the food is positioned centrally in the oven.
Food is taking too long to cook	Only cook one item at a time to avoid overloading the oven.

Disposal of your product

To minimise the risk of injury to children please dispose of your product carefully and safely. Remove all doors and lids. Remove the mains cable (where fitted) by cutting off flush with the appliance and always ensure that no plug is left in a condition where it could be connected to the electricity supply. To help the environment, Local Authority instructions should be followed for the disposal of your product.

This appliance conforms to the following EEC Directives:

Electromagnetic Compatibility
89/336/EEC
92/31/EEC
93/68/EEC

Low Voltage Equipment
73/23/EEC
93/68/EEC



The European Directive 2002/96/EC on Waste Electrical and Electronic Equipment (WEEE), requires that old household electrical appliances must not be disposed of in the normal unsorted municipal waste stream. Old appliances must be collected separately in order to optimise the recovery and recycling of the materials they contain and reduce the impact on human health and the environment. The crossed out "wheeled bin" symbol on the product reminds you of your obligation, that when you dispose of the appliance it must be separately collected.

Consumers should contact their local authority or retailer for information concerning the correct disposal of their old appliance.

Something Wrong with your Cooker?

Before contacting your nearest Service Centre/Installer, check the problem guide below; there may be nothing wrong with your cooker.





Problem	
Slight odour or small amount of smoke when using the cooker for the first time.	This is normal and should cease after a short period.
Nothing Works	Is the main cooker wall switch turned on? There may be no electricity supply.
Oven temperature seems too high or too low.	Check that the temperature has been set in accordance with the temperature charts. It may be necessary to increase or decrease the recommended temperature by up to 10°C to suit your taste.
Oven does not cook evenly.	Check that the temperature and shelf position are as recommended in the temperature charts. Check that the containers being used in the oven allow sufficient air flow around them. Check that the cooker is level.
Hotplates are slow to boil or will not simmer	Check that your pans conform to the recommendations in these instructions.
Marks appearing on hotplates. Can not clean hob / hotplates.	The hob surround can be cleaned with warm soapy water and a cream cleaner, such as Cif. The sealed hotplates should be cleaned regularly, (please refer to the Care and Cleaning section for further information. Please note that replacement hob cleaning kits are available from our parts department, see Key Contacts, back page.
Grill not working.	The grill door MUST be open.
Grill keeps turning on and off.	When the grill control is operated at a setting less than maximum, this is normal regulator operation, not a fault.
Condensation on the wall at the rear of the cooker.	Steam and/or condensation may appear from the vent at the rear of the appliance when using an oven particularly for foods with a high water content e.g. frozen chips, roast chicken etc. This is normal and any excess should be wiped off.
Steam / Condensation in the oven after use.	Steam is a by-product of cooking any food with a high water content. To help minimise always: a) Try to avoid leaving food in the oven to cool after being cooked. b) Use a covered container, wherever possible

Electronic timer

The electronic timer displays the time and the timer function with countdown.

To set the clock





Note: This may be set while the oven is switched off or while it is switched on.

1. Press the  button several times until the  icon and the first two numerical digits on the display start to flash.
2. Use the "+" and "-" buttons to adjust the hour value.
3. Press the  button again so that the other two numerical digits on the DISPLAY begin to flash.
4. Use the "+" and "-" buttons to adjust the minute value.
5. Press the  button again to confirm.

Note: If none of the buttons are pressed, the settings will be confirmed automatically after 10 seconds have passed.

To set the timer

Note: This function does not interrupt cooking and does not affect the oven; it is simply used to activate the buzzer when the set amount of time has elapsed.

1. Press the  button several times until the  icon and the first two numerical digits on the display start to flash.
2. Use the "+" and "-" buttons to adjust the hour value.
3. Press the  button again so that the other two numerical digits on the DISPLAY begin to flash.
4. Use the "+" and "-" buttons to adjust the minute value.
5. Press the  button again to confirm.

The countdown will then be displayed; at the end of this period of time the buzzer will sound (this may be stopped by pressing any of the buttons, or it will stop of its own accord after one minute).

To cancel a previous setting

Press button "-" up until 0 • 00.

Technical Characteristics

Top Oven

Dimensions (HxWxD): 18,3x36x42,5 cm

Volume: 28 Litres

Max. Oven Power Absorption: 2500 W

ENERGY LABEL - Top Oven

Directive 2002/40/EC on the label of electric ovens

Norm EN 50304

Declared energy consumption for Natural convection Class

heating mode: Static

Main Oven

Dimensions (HxWxD): 34x39x41 cm

Volume: 54 Litres

Max. Oven Power Absorption: 1700 W

ENERGY LABEL - Main Oven

Directive 2002/40/EC on the label of electric ovens

Norm EN 50304

Declared energy consumption for Natural convection Class

heating mode: Fan oven

Voltage and Frequency

240V~ 50Hz



After Sales Service

"No company is better positioned to offer an after sales service on a Hotpoint appliance than us - the manufacturer"

As part of our commitment to you, all Hotpoint appliances have the added benefit of a fully inclusive parts and labour guarantee for the first 12 months. In addition to this you also have the advantage of **free replacement parts for the first 5 years** when fitted by a Hotpoint engineer. When the 12 months parts and labour guarantee expires we offer the following after sales service options:

Repair Service and Information Help Desk

UK: 08709 066066

www.theservicecentre.co.uk

Republic of Ireland: 1850 302 200

Note: Our operators will require the Model number and the Serial number of your appliance

Available 364 days a year with a fast, effective and value for money service. We have the largest white goods repair service in the UK with over 1200 of our own fully trained engineers. All repairs include a parts and labour guarantee for 12 months from the date of the repair.

If you require any information or have any questions about your appliance, our operators are on hand with help and advice.

All this ensures that you will receive the best available after sales service possible.

Extended Warranties

UK: 08709 088 088

www.theservicecentre.co.uk

Republic of Ireland: 1850 502 200

Whether you have just one or a number of Hotpoint appliances in your kitchen, we offer two service cover plans to give you total peace of mind.

- Repair Protection Plan - FREE service repairs for a single Hotpoint appliance during the period of cover.
- Kitchen Cover - FREE service repairs for all your Hotpoint appliances less than 8 years old.

Genuine Parts and Accessories UK: 08709 077 077

www.theservicecentre.co.uk

Republic of Ireland: (01) 842 6836

A wide range of genuine parts and accessories are available from our hotline or through our web site.

Genuine parts and accessories, extended warranties and service repairs are all available on our web-site at:



www.theservicecentre.co.uk



Guarantee

"Satisfaction guaranteed or your money back"

We give you a unique 'satisfaction guaranteed' promise - **valid for 90 days** - after you have purchased your Hotpoint appliance. If there is a technical problem simply call Hotpoint Repair service or visit our web-site at www.theservicecentre.co.uk and where necessary, we will arrange for an engineer to call. If the technical problem is not resolved under this guarantee, **we will replace your machine or, if you prefer, give you your money back.**

All Hotpoint appliances carry a fully inclusive 12 month parts and labour guarantee as well as free replacement parts for the first 5 years (except microwaves, selected integrated appliances and cooker hoods, which have a one year guarantee) provided that they are fitted by a Hotpoint engineer.

Guarantee terms and conditions

Your guarantee is only applicable in the United Kingdom or Republic of Ireland and is subject to the following provisions that your appliance:

- Has been installed and used correctly in accordance with this instruction booklet.
- Has been used solely for domestic purposes and is located on domestic premises (ie. not for commercial or trade use).
- Has been properly connected to a suitable electrical supply voltage as stated on the appliance rating plate.
- Has not been subject to misuse, accident, modified or repaired by anyone other than one of our own service engineers.



For pre purchase information on any other Hotpoint product call: 08701 50 60 70
or visit: www.hotpoint.co.uk



Recycling & Disposal Information

As part of Hotpoint's continued commitment to helping the environment, Hotpoint reserves the right to use quality recycled components to keep down customer costs and minimise material wastage.

Please dispose of packaging and old appliances carefully.

To minimise risk of injury to children, remove the plug and cut mains cable off flush with the appliance. Dispose of these parts separately to ensure that the appliance can no longer be plugged into a mains socket.



Key Contacts

After Sales Service

Over 1200 trained specialists, directly employed by us, ensure that you can have complete confidence in both the appliances and services we offer.



Repair Service and Information Desk

UK: 08709 066 066

(Open 8 to 8 Mon - Fri, 8 to 6 Sat, 10 to 4 Sun & Bank Holidays)

www.theservicecentre.co.uk

Republic of Ireland: 1850 302 200

Note: Our operators will require the following information:

Model number:

Serial number:

Extended Warranties

UK: 08709 088 088

(Open 8 to 8 Mon - Sun)

www.theservicecentre.co.uk

Republic of Ireland: 1850 502 200

Genuine Parts and Accessories

UK: 08709 077 077

(Open 8-30 to 5-30 Mon - Fri & 9 to 12 Sat)

www.theservicecentre.co.uk

Republic of Ireland: (01) 842 6836

Indesit Company UK LTD, Morley Way, Peterborough, PE2 9JB.

04/2007 - 19506051000

Free Manuals Download Website

<http://myh66.com>

<http://usermanuals.us>

<http://www.somanuals.com>

<http://www.4manuals.cc>

<http://www.manual-lib.com>

<http://www.404manual.com>

<http://www.luxmanual.com>

<http://aubethermostatmanual.com>

Golf course search by state

<http://golfingnear.com>

Email search by domain

<http://emailbydomain.com>

Auto manuals search

<http://auto.somanuals.com>

TV manuals search

<http://tv.somanuals.com>