

Operating Instructions

FREEZER

GB

English, 1

RZ150P
RZ150G

Contents

GB

Installation, 2-3

Positioning and connection
Reversible doors

Description of the appliance, 4

Overall view

Start-up and use, 5

Starting the appliance
Using the freezer to its full potential

Maintenance and care, 6

Switching the appliance off
Cleaning the appliance
Avoiding mould and unpleasant odours
Defrosting the appliance

Precautions and tips, 7

General safety
Disposal
Respecting and conserving the environment

Troubleshooting, 8

Guarantee, 9

After Sales Service, 10

 **Hotpoint**

Installation

GB

! Before placing your new appliance into operation please read these operating instructions carefully. They contain important information for safe use, for installation and for care of the appliance.

! Please keep these operating instructions for future reference. Pass them on to possible new owners of the appliance.

Positioning and connection

Positioning

1. Place the appliance in a well-ventilated humidity-free room.
2. Do not obstruct the rear fan grills. The compressor and condenser give off heat and require good ventilation to operate correctly and save energy.
3. Leave a space of at least 10 cm between the top part of the appliance and any furniture above it, and at least 5 cm between the sides and any furniture/side walls.
4. Ensure the appliance is away from any sources of heat (direct sunlight, electric stove, etc.).
5. In order to maintain the correct distance between the appliance and the wall behind it, fit the spacers supplied in the installation kit, following the instructions provided.

Levelling

1. Install the appliance on a level and rigid floor.
2. If the floor is not perfectly horizontal, adjust the refrigerator by tightening or loosening the rear feet.

Electrical connections

After the appliance has been transported, carefully place it vertically and wait at least 3 hours before connecting it to the electricity mains. Before inserting the plug into the electrical socket ensure the following:

- The appliance is earthed and the plug is compliant with the law.
- The socket can withstand the maximum power of the appliance, which is indicated on the data plate located inside the freezer (e.g. 150 W).
- The voltage is in the range of values indicated on the data plate located inside the freezer (e.g. 220-240V).
- The socket is compatible with the plug of the appliance. If the socket is incompatible with the plug, ask an authorised technician to replace it (see Assistance). Do not use extension cords or multiple sockets.

! Once the appliance has been installed, the power supply cable and the electrical socket must be easily accessible.

! The cable must not be bent or compressed.

! The cable must be checked regularly and replaced by authorised technicians only (see Assistance).

! The manufacturer declines any liability should these safety measures not be observed.

Connection of the water supply

To carry this out, use the kit provided which contains all the necessary elements for connection to the water supply. To improve the performance of the Aqua Care, we recommend that you fit a tap with a filter on the pipe for the connection to the water system: in this way it will be possible to manually interrupt the water supply during long periods in which Aqua Care is not used.

! The water pressure inside the water system must be between 0.8 bar and 8 bar.

! The appliance must only be connected to a water supply suitable for drinking.

Your appliance is supplied with a 13amp fused plug that can be plugged into a 13amp socket for immediate use. Before using the appliance please read the instructions below.

WARNING:

THIS APPLIANCE MUST BE EARTHED.

Replacing fuse covers:

When replacing a faulty fuse, a 13amp ASTA approved fuse to BS 1362 should always be used and the fuse cover re-fitted.

If the fuse cover is lost, the plug must not be used until a replacement is obtained.

Replacement fuse covers:

If a replacement fuse cover is fitted, it must be of the correct colour as indicated by the coloured marking or the colour that is embossed in words on the base of the plug.

Changing the plug:

Removing the plug

If your appliance has a non-rewireable moulded plug and you should wish to remove it to add a longer cable or to re-route the mains cable through partitions, units etc. please ensure that either:

- The plug is replaced by a fused 13amp re-wireable plug bearing the BSI mark of approval.

or

- The mains cable is wired directly into a 13amp cable outlet, controlled by a switch (in compliance with BS 5733) which is accessible without moving the appliance.

Disposing of the plug

Cut off and dispose of the supplied plug if it does not fit your socket. The cable should be cut as close as possible to the moulded plug.
Remove the fuse.

WARNING:

To avoid a shock hazard do not insert the discarded plug into a socket anywhere else.

Fitting a new plug

IMPORTANT:

WIRES IN THE MAINS LEAD ARE COLOURED IN ACCORDANCE WITH THE FOLLOWING CODE...

Green and Yellow	- Earth
Blue	- Neutral
Brown	- Live

As the colours of the wires in the mains lead may not correspond with the coloured markings identifying the terminals in your plug, proceed as follows:

- Connect Green and Yellow wire to terminal marked 'E' or  or coloured Green and Yellow.
- Connect Brown wire to terminal marked 'L' or coloured red or brown.
- Connect Blue wire to terminal marked 'N' or coloured Black or Blue.

If a 13amp plug (BS 1363) is used it must be fitted with a 13amp fuse. A 15amp plug must be protected by a 15amp fuse, either in the plug or adaptor or at the distribution board.

If you are in any doubt about the electrical supply to your machine, consult a qualified electrician before use.

CE Marking certifies that this appliance conforms to the following EEC directives :
Low Voltage Equipment - 73/23/EEC & 93/68 EEC
Electromagnetic Compatibility 89/336/EEC, 92/31/EEC & 93/68/EEC

Reversible door

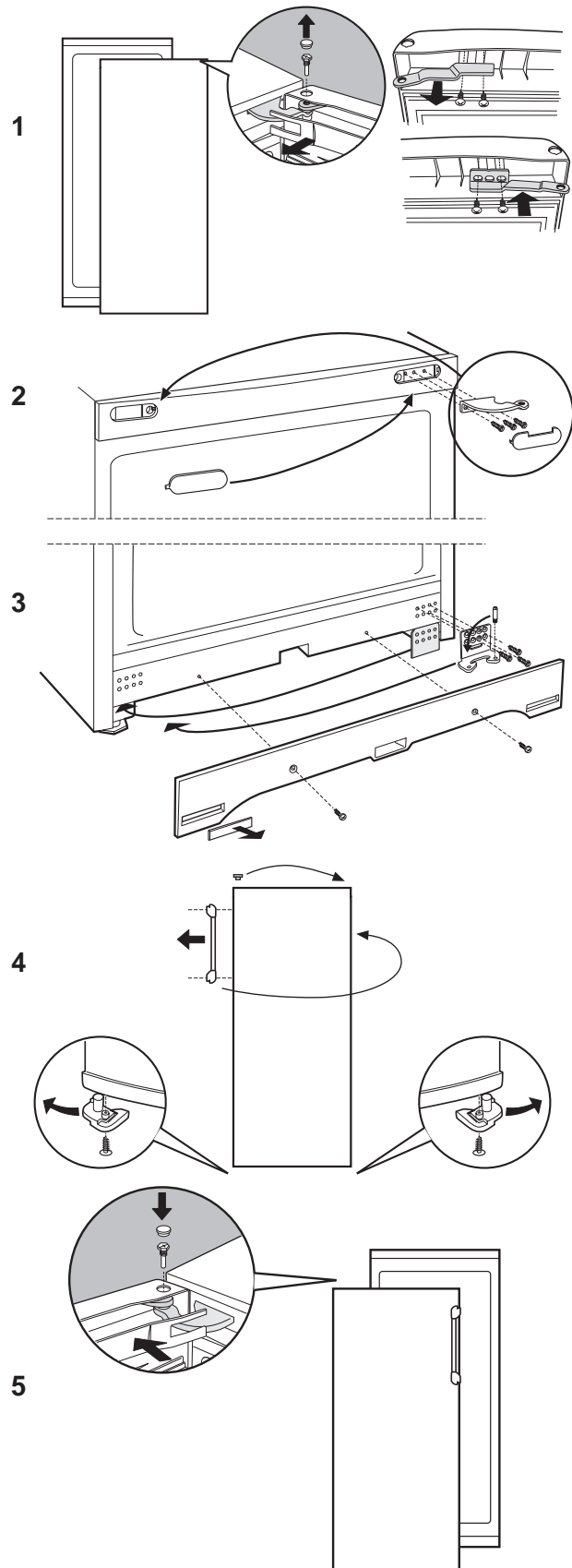

Description of the appliance

GB

Overall view

The instructions contained in this manual are applicable to different model refrigerators. The diagrams may not directly represent the appliance purchased.

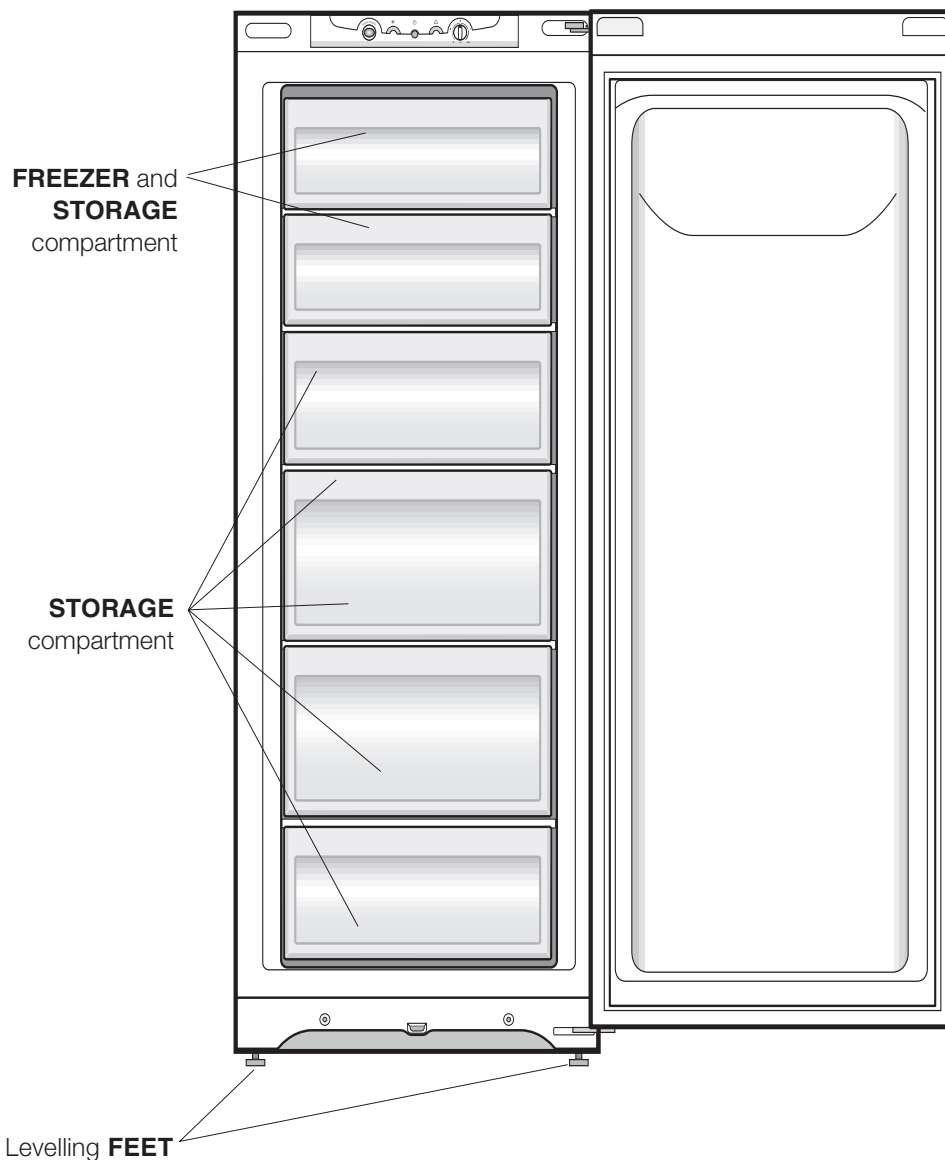
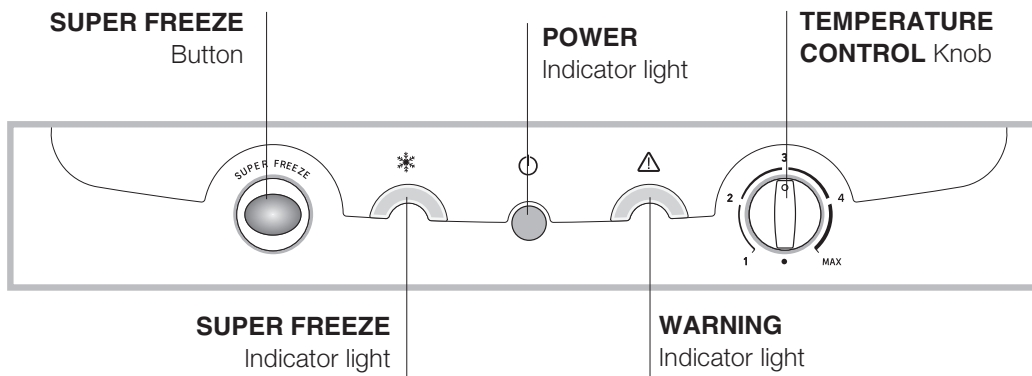

Starting the appliance

! Before starting the appliance, follow the installation instructions (see *Installation*).

! Before connecting the appliance, clean the compartments and accessories well with lukewarm water and bicarbonate.

1. Insert the plug into the socket and ensure that the red ALARM and green POWER indicator lights illuminate (the TEMPERATURE ADJUSTMENT knob must not be on ●).
2. Press the SUPER FREEZE button (rapid freezing): the SUPER FREEZE indicator light will illuminate.
3. When the indicator light switches off, press the SUPER FREEZE button. The freezer is now ready to be used.

Using the freezer to its full potential

- Use the TEMPERATURE CONTROL knob to adjust the temperature.
1 = warmest **MAX** = coldest
We recommend, however, a medium position.
- Do not re-freeze food that is defrosting or that has already been defrosted. These foods must be cooked and eaten (within 24 hours).
- Fresh food that needs to be frozen must not come into contact with food that has already been defrosted. Fresh food must be stored in the top FREEZER and STORAGE compartment.
- Do not place glass bottles which contain liquids, and which are corked or hermetically sealed in the freezer because they could break.
- The maximum quantity of food that may be frozen daily is indicated on the plate containing the technical properties located within the freezer (for example: Kg/24h: 4).
- To freeze (if the freezer is already operating):
 - for small quantities which are less than those indicated on the data plate, press the rapid freezing SUPER FREEZE button (the corresponding yellow indicator light illuminates), place the food inside and close the door. After 24 hours press the SUPER FREEZE button.
 - for large quantities which are greater than the maximum load indicated on the data plate, hold down the rapid freezing SUPER FREEZE button. After 24 hours place the food inside the freezer and close the door. After another 24 hours press the SUPER FREEZE button.
- Placing large amounts of fresh food in the freezer may temporarily increase the temperature inside the appliance (this is indicated when the red ALARM light illuminates). This situation, as it is only temporary, does not adversely affect the storage conditions of food that is already frozen.

- In order to obtain a greater amount of space in the freezer compartment, you may remove the bins and place the food directly onto the evaporator plates.

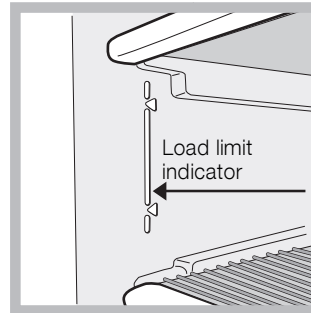

If the top drawer is not used DO NOT store food beyond the line embossed in the interior of the freezer cabinet wall. This indicates the load limit. Food beyond this line will limit the air circulation and affect the performance of the freezer.

! Do not open the door during freezing.

! If there is a power cut or malfunction, do not open the freezer door. This will help maintain the temperature inside the freezer, ensuring that foods are conserved for at least 9 -14 hours.

! Warning Indicator Light. When this red warning light comes on for a prolonged period of time, it means that the freezer is not functioning properly and the temperature is rising too much. (Call your Service Centre)
This warning light might come on for a brief period when:
a) the door is left open for an extended period of time (when the freezer is being loaded or unloaded).
b) the SUPER FREEZE button has been pressed.

In these two cases, the fact that the warning light comes on does not indicate that the freezer is malfunctioning or there is a defect.

Maintenance and care

GB

Switching the appliance off

During cleaning and maintenance it is necessary to disconnect the appliance from the electricity supply:

1. set the TEMPERATURE CONTROL Knob on ●;
2. pull the plug out of the socket.

Cleaning the appliance

- The external and internal parts, as well as the rubber seals may be cleaned using a sponge that has been soaked in lukewarm water and bicarbonate of soda or neutral soap. Do not use solvents, abrasive products, bleach or ammonia.
- The removable accessories may be soaked in warm water and soap or dishwashing liquid. Rinse and dry them carefully.
- The back of the appliance may collect dust which can be removed by delicately using the hose of a vacuum cleaner set on medium power. The appliance must be switched off and the plug must be pulled out before cleaning the appliance.

Avoiding mould and unpleasant odours

- The appliance is manufactured with hygienic materials which are odour free. In order to maintain an odour free refrigerator and to prevent the formation of stains, food must always be covered or sealed properly.
- If you want to switch the appliance off for an extended period of time, clean the inside and leave the doors open.

Defrosting the appliance

! Follow the instructions below.

Do not use objects with sharp or pointed edges to defrost the appliance as these may damage the refrigeration circuit beyond repair.

If the frost layer is greater than 5 mm, it is necessary to defrost manually:

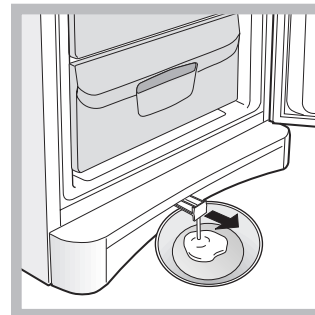

1. The day before defrosting, press the SUPER FREEZE button (the yellow SUPER FREEZE indicator light illuminates) to further cool the food.
2. After 24 hours, turn the TEMPERATURE ADJUSTMENT knob to ●, which will switch the refrigerator off.
3. Wrap frozen foods in newspaper and place them in another freezer or in a cool place.
4. Leave the door open until the frost has melted completely. This can be made easier by placing containers with lukewarm water in the freezer compartment..



5. Certain appliances are fitted with the DRAIN SYSTEM to lead the water outside. Let the water flow into a container (see *diagram*).

6. Clean and dry the freezer compartment carefully before switching the appliance on again.
7. Wait for approximately 2 hours, i.e. until the ideal storage conditions have been restored, before placing food in the freezer compartment.

! The appliance was designed and manufactured in compliance with international safety standards. The following warnings are provided for safety reasons and must be read carefully.

 This appliance complies with the following Community Directives:
- 73/23/EEC of 19/02/73 (Low Voltage) and subsequent amendments;
 -89/336/EEC of 03.05.89 (Electromagnetic Compatibility) and subsequent amendments;
 - 2002/96/CE..

General safety

- The appliance was designed for domestic use inside the home and is not intended for commercial or industrial use.
- The appliance must be used to store and freeze food products by adults only and according to the instructions in this manual.
- The appliance must not be installed outdoors, even in covered areas. It is extremely dangerous to leave the appliance exposed to rain and storms.
- Do not touch the appliance with bare feet or with wet or moist hands and feet.
- WARNING: do not damage the refrigerant circuit.
- Do not touch the internal cooling elements: this could cause skin abrasions or frost/freezer burns.
- When unplugging the appliance always pull the plug from the mains socket, do not pull on the cable.
- Before cleaning and maintenance, always switch off the appliance and disconnect it from the electrical supply. It is not sufficient to set the temperature adjustment knobs on ● (appliance off) to eliminate all electrical contact.
- In the case of a malfunction, under no circumstances should you attempt to repair the appliance yourself. Repairs carried out by inexperienced persons may cause injury or further malfunctioning of the appliance.
- Do not use any sharp or pointed utensils or electrical equipment - other than the type recommended by the manufacturer - inside the frozen food storage compartments.
- Do not put ice cubes taken directly from the freezer into your mouth.
- Do not allow children to tamper with the controls or play with the appliance. Under no circumstance should they be allowed to sit on the bins or to hang from the door.
- Keep packaging material out of the reach of children! It can become a choking or suffocation hazard.

Disposal

- Observe local environmental standards when disposing packaging material for recycling purposes.
- The European Directive 2002/96/EC on Waste Electrical and Electronic Equipment (WEEE), requires that old household electrical appliances must not be disposed of in the normal unsorted municipal waste stream. Old appliances must be collected separately in order to optimise the recovery and recycling of the materials they contain and reduce the impact on human health and the environment. The crossed out “wheeled bin” symbol on the product reminds you of your obligation, that when you dispose of the appliance it must be separately collected.
Consumers should contact their local authority or retailer for information concerning the correct disposal of their old appliance.

Respecting and conserving the environment

- Install the appliance in a fresh and well-ventilated room. Ensure that it is protected from direct sunlight and do not place it near heat sources.
- Try to avoid keeping the door open for long periods or opening the door too frequently in order to conserve energy.
- Do not fill the appliance with too much food: cold air must circulate freely for food to be preserved properly. If circulation is impeded, the compressor will work continuously.
- Do not place hot food directly into the refrigerator. The internal temperature will increase and force the compressor to work harder and will consume more energy.
- Defrost the appliance if ice forms (*see Maintenance*). A thick layer of ice makes cold transference to food products more difficult and results in increased energy consumption.
- Regularly check the door seals and wipe clean to ensure they are free of debris and to prevent cold air from escaping (*see Maintenance*).

Troubleshooting

GB

If the appliance does not work, before calling for Assistance (*see Assistance*), check for a solution from the following list.

Malfunctions:

The green POWER indicator light does not illuminate.

The ALARM indicator light remains illuminated constantly.

The motor runs continuously.

The appliance makes a lot of noise.

Possible causes / Solutions:

- The plug has not been inserted into the electrical socket, or not far enough to make contact, or there is no power in the house.
- The door is not closed properly or has been open continuously.
- The door has been opened too frequently.
- The TEMPERATURE ADJUSTMENT knob is not in the correct position.
- The SUPER FREEZE button has been pressed (rapid freezing): the yellow SUPER FREEZE light is on or flashing (*see Description*).
- The door is not closed properly or is continuously opened.
- The outside ambient temperature is very high.
- The thickness of the frost exceeds 2-3 mm (*see Maintenance*).
- The appliance has not been installed on a level surface (*see Installation*).
- The appliance has been installed between cabinets that vibrate and make noise.
- The internal refrigerant makes a slight noise even when the compressor is off. This is not a defect, it is normal.

Guarantee

12 Months Parts and Labour Guarantee

Your appliance has the benefit of our manufacturer's guarantee, which covers the cost of breakdown repairs for twelve months from the date of purchase.

This gives you the reassurance that if, within that time, your appliance is proven to be defective because of either workmanship or materials, we will, at our discretion, either repair or replace the appliance at no cost to you.

This guarantee is subject to the following conditions:

- The appliance has been installed and operated correctly and in accordance with our operating and maintenance instructions.
- The appliance is used only on the electricity or gas supply printed on the rating plate.
- The appliance has been used for normal domestic purposes only.
- The appliance has not been altered, serviced, maintained, dismantled, or otherwise interfered with by any person not authorised by us.
- Any repair work must be undertaken by us or our appointed agent.
- Any parts removed during repair work or any appliance that is replaced become our property.
- The appliance is used in the United Kingdom or Republic of Ireland.

The guarantee does not cover:

- Damage resulting from transportation, improper use, neglect or interference or as a result of improper installation.
- Replacement of any consumable item or accessory . These include but are not limited to: plugs, cables, batteries, light bulbs, fluorescent tubes and starters, covers and filters.
- Replacement of any removable parts made of glass or plastic.

THIS GUARANTEE WILL NOT APPLY IF THE APPLIANCE HAS BEEN USED IN COMMERCIAL OR NON-DOMESTIC PREMISES.

5 Year Parts Guarantee

Hotpoint also offers you a free 5 year parts guarantee. This additional guarantee is conditional on you registering your appliance with us and the parts being fitted by one of our authorised engineers. There will be a charge for our engineer's time. To activate the extra parts warranty on your appliance, simply call our registration line on 0870 6092094 (ROI 01 230 0800).

Extended Guarantees

We offer a selection of repair protection plans that enable you to fully cover yourself against the expense of repair bills for the life of your policy. To find the ideal plan for you please call our advice line on 08709 088 088 (ROI 01 230 0233).

Free Helpdesk Service

We have a dedicated team who can provide free advice and assistance with your appliance if you experience any technical difficulties within the first 90 days of ownership. Simply call our Hotpoint Service Hotline on 08709 066 066 (ROI 0818 313 413) for telephone assistance, or, where necessary, to arrange for an engineer to call. If we cannot resolve the technical problem we will replace your machine or, if you prefer, give you your money back.

After Sales Service

No one is better placed to care for your Hotpoint appliance during the course of its working life than us - the manufacturer.

Essential Contact Information

Hotpoint Service

We are the largest service team in Europe offering you access to 400 skilled telephone advisors and 1100 fully qualified engineers on call to ensure you receive fast, reliable, local service.

UK: 08709 066 066

Republic of Ireland: 0818 313 413

www.hotpointservice.co.uk

Please note: Our advisors will require the following information:

Model number:

Serial number:

Parts and Accessories

We supply a full range of genuine replacement parts as well as accessory products that protect and hygienically clean your appliance to keep it looking good and functioning efficiently throughout its life.

UK: 08709 077 077

Republic of Ireland: 0818 313 413

www.hotpointservice.co.uk

Appliance Registration

We want to give you additional benefits of Hotpoint ownership. To activate your free 5 year parts guarantee you must register your appliance with us.

UK: 0870 6092094

Republic of Ireland: 01 230 0800

www.hotpointservice.co.uk

Indesit Company UK Ltd. Morley Way, Peterborough, PE2 9JB

Indesit Company Unit 49 Airways Industrial Estate, Dublin 17

Recycling & Disposal Information

As part of Hotpoint's continued commitment to helping the environment, Hotpoint reserves the right to use quality, recycled components to keep down customer costs and minimise material wastage.

Please dispose of packaging and old appliances carefully. Please see section "Precautions and tips" for details about disposal legislation. To minimise the risk of injury to children, remove the door, plug and cut the mains cable off flush with the appliance. Dispose of these parts separately to ensure that the appliance can no longer be plugged into a mains socket, and the door cannot be locked shut.

Free Manuals Download Website

<http://myh66.com>

<http://usermanuals.us>

<http://www.somanuals.com>

<http://www.4manuals.cc>

<http://www.manual-lib.com>

<http://www.404manual.com>

<http://www.luxmanual.com>

<http://aubethermostatmanual.com>

Golf course search by state

<http://golfingnear.com>

Email search by domain

<http://emailbydomain.com>

Auto manuals search

<http://auto.somanuals.com>

TV manuals search

<http://tv.somanuals.com>