

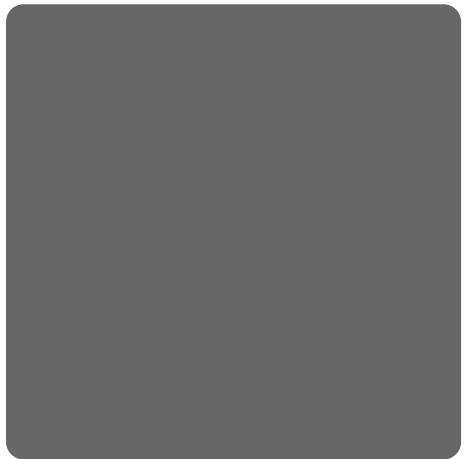

Designed for the real world

Instructions



DE77
DQ77
DE47
DQ47

Introduction

Your new appliance is guaranteed* and will give lasting service. This guarantee is only applicable if the appliance has been installed in accordance with the installation instructions detailed in this booklet.

To help make best use of your cooking equipment, please read this booklet carefully.

The appliance is designed specifically for domestic use and responsibility will not be accepted for use in any other installation.

**When the cooker is first used an odour may be emitted,
this will cease after a period of use**

To help remove the 'new' smell, heat up the empty ovens to maximum temperature for a minimum of two or three hours, keeping the oven doors closed. Ensure that the room is well ventilated (e.g. open a window or use an extractor fan) and that persons who may be sensitive to the odour avoid any fumes.

It is suggested that any pets be removed from the room until the smell has ceased.

This odour is due to temporary finish on oven liners and elements and also any moisture absorbed by the insulation.

*** The guarantee is subject to the provisions that the appliance:**

- (a) Has been used solely in accordance with the Users Instruction Book.
- (b) Has been properly connected to a suitable supply voltage as stated on the rating plate attached to this equipment.
- (c) Has not been subjected to misuse or accident or been modified or repaired by any person other than the authorised employee or agent.
- (d) Has been correctly installed.

This appliance conforms to the following EEC Directives:

Electromagnetic Compatibility	Low Voltage Equipment
89/336/EEC	73/23/EEC
92/31/EEC	93/68/EEC
93/68/EEC	



Safety Information

**When used properly your appliance is completely safe but as with any electrical product there are certain precautions that must be observed.
PLEASE READ THE PRECAUTIONS BELOW BEFORE USING YOUR APPLIANCE.**

Always

- Always make sure you remove all packaging and literature from inside the oven and grill compartments before switching on for the first time.
- Always make sure you understand the controls prior to using the appliance.
- Always keep children away from the appliance when in use as the surfaces will get extremely hot during and after cooking.
- Always make sure all controls are turned off when you have finished cooking and when not in use.
- Always stand back when opening an oven door to allow any build up of steam or heat to disperse.
- Always use dry, good quality oven gloves when removing items from the oven/grill.
- Always take care to avoid heat/steam burns when operating the controls.
- Always turn off the electricity supply at the wall switch before cleaning and allow the appliance to cool.
- Always make sure the shelves are in the correct position before switching on the oven.
- Always keep the oven and grill doors closed when the appliance is not in use.
- Always take care when removing utensils from the top oven when the main oven is in use as the contents may be hot.
- Always keep the appliance clean as a build up of grease or fat from cooking can cause a fire.
- Always follow the basic principles of food handling and hygiene to prevent the possibility of bacterial growth.
- Always keep ventilation slots clear of obstructions.
- Always refer servicing to a qualified appliance service engineer.
- During use the oven becomes hot. Care should be taken to avoid touching heating elements inside the oven,

SAFETY ADVICE

IN THE EVENT OF A CHIP PAN OR ANY OTHER PAN FIRE:

1. TURN OFF THE COOKER APPLIANCE AT THE WALL SWITCH.
2. COVER THE PAN WITH A FIRE BLANKET OR DAMP CLOTH, this will smother the flames and extinguish the fire.
3. LEAVE THE PAN TO COOL FOR AT LEAST 60 MINUTES BEFORE MOVING IT. Injuries are often caused by picking up a hot pan and rushing outside with it. NEVER USE A FIRE EXTINGUISHER TO PUT OUT A PAN FIRE as the force of the extinguisher is likely to tip the pan over. Never use water to extinguish oil or fat fires.

Safety Information

Never

- Never leave children unsupervised where a cooking appliance is installed as all cooking surfaces will be hot during and after use.
- Never allow anyone to sit or stand on any part of the appliance.
- Never store items above the appliance that children may attempt to reach.
- Never remove the oven shelves whilst the oven is hot.
- Never heat up unopened food containers as pressure can build up causing the container to burst.
- Never store chemicals, food stuffs or pressurised containers in or on the appliance, or in cabinets immediately above or next to the appliance.
- Never operate the grill with the door closed as this will cause the appliance to overheat.
- Never use the appliance as a room heater.
- Never use the grill to warm plates.
- Never dry any items on the oven doors.
- Never install the appliance next to curtains or other soft furnishings.
- Never allow children to play with the appliance controls.
- Never use 'steam cleaners'.

The main parts of your Double Oven (DE77 & DQ77)

WARNING: DO NOT TOUCH THE GLASS DOORS WHEN THE OVEN IS IN USE AS THESE AREAS CAN BECOME HOT.

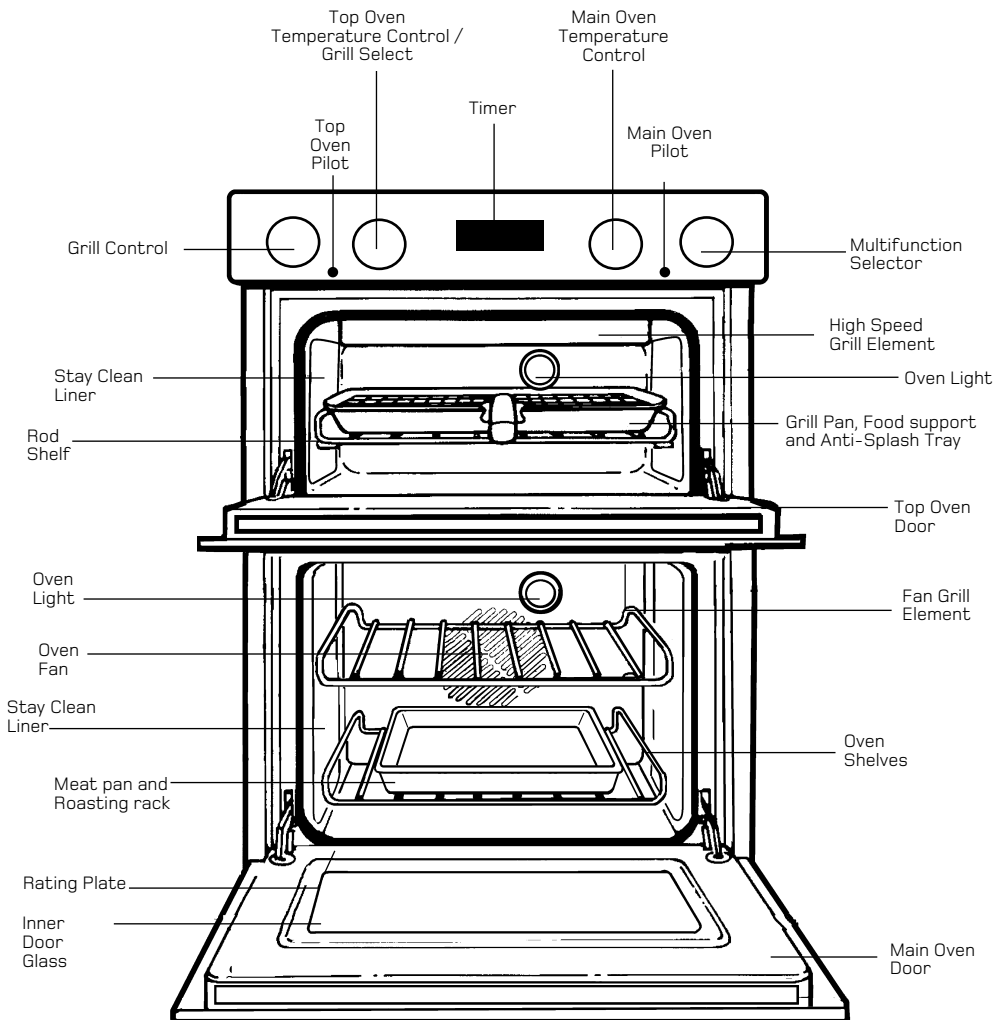

NEVER line the shelves, floor or sides of the oven or grill with aluminium foil as overheating and damage may result.

The main parts of your Double Oven (DE47 & DQ47)

WARNING: DO NOT TOUCH THE GLASS DOORS WHEN THE OVEN IS IN USE AS THESE AREAS CAN BECOME HOT.

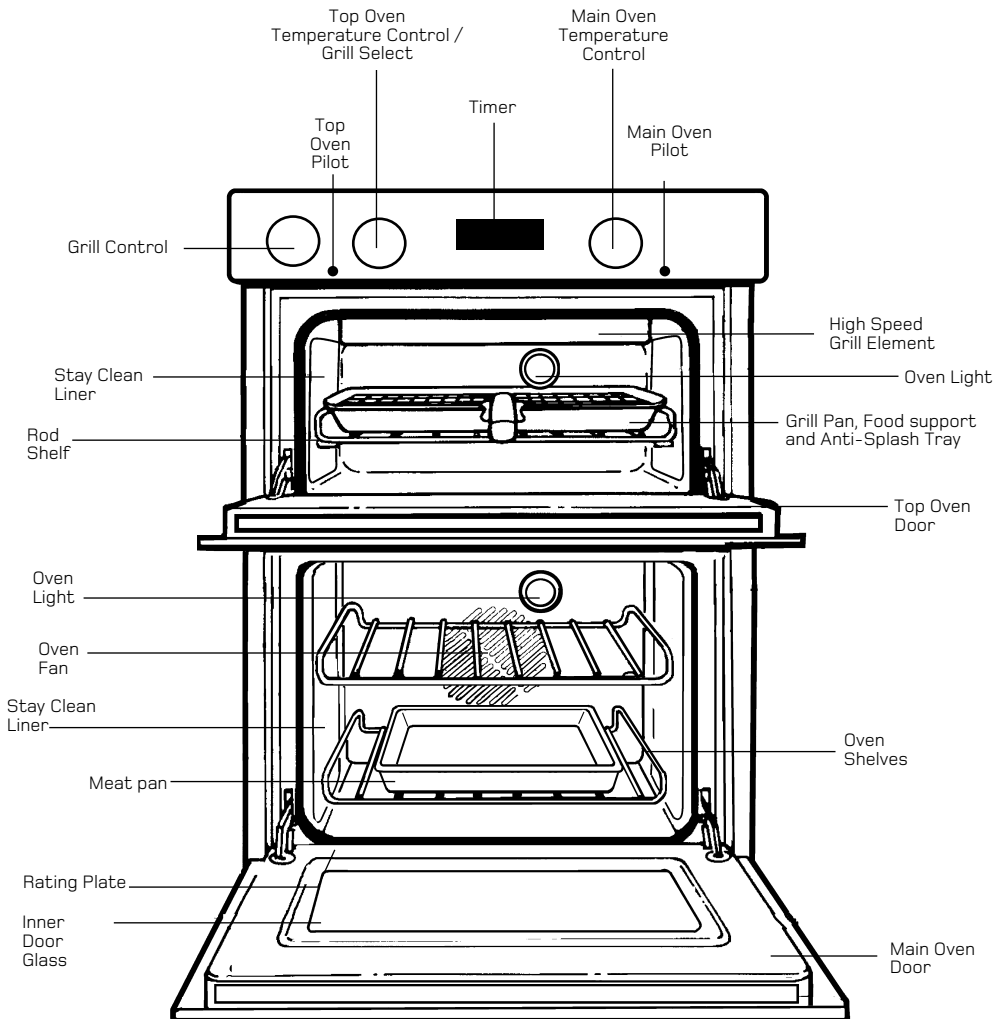

NEVER line the shelves, floor or sides of the oven or grill with aluminium foil as overheating and damage may result.

Temperature Conversion Chart

The chart below gives details of comparisons of oven settings for gas conventional ovens and fan oven in degrees °F and °C

GAS MARK	CONVENTIONAL OVEN		FAN OVEN
	°F	°C	°C
1/2	250	120	100
1	275	140	120
2	300	150	130
3	325	160	140
4	350	180	160
5	375	190	170
6	400	200	180
7	425	220	200
8	450	230	210
9	475	240	220

The Controls (DE77 & DQ77)

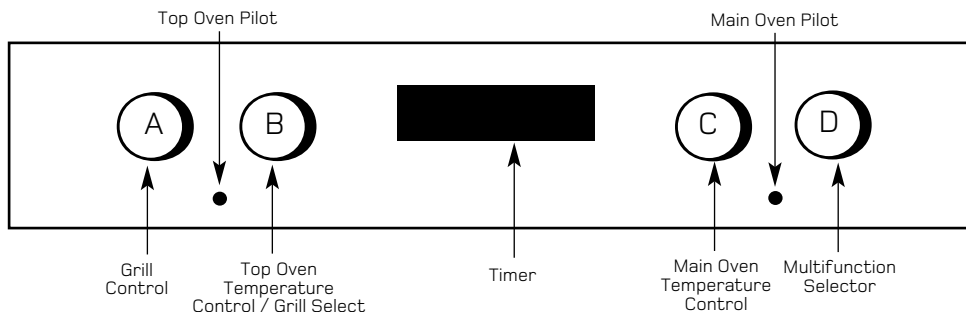

IMPORTANT

Before using your oven in the ordinary way, ALWAYS make sure that the timer has been set to MANUAL operation. Unless this is done, the main oven cannot heat up. Before seeking assistance, make sure this is done (refer to oven timer operation).

MULTIFUNCTION SELECTOR

Rotate the control knob in either direction to the required function. Many of the functions will also require the main oven thermostat to be set before the oven will heat up.

MAIN OVEN TEMPERATURE CONTROL

This is used in addition to the multifunction selector. This is used for the functions: fan oven, fan grill, half grill and full grill and conventional oven. Turn the control clockwise to set the oven thermostat to the required temperature.

If the timer is set correctly and the selector switch set to a suitable function an indicator light will illuminate. This will remain on until the oven reaches the required temperature. This light will then cycle on and off as the thermostat maintains control of the oven temperature.

TOP OVEN TEMPERATURE CONTROL

Turn the control clockwise to set the top oven thermostat to the required temperature. An indicator light will illuminate. This will remain on until the oven reaches the required temperature. This light will then cycle on and off as the thermostat maintains control of the oven thermostat.

GRILL CONTROL

The grill control is designed to provide variable heat control of either both grill elements on together or the single left-hand grill element only. Turn the top oven control clockwise past the temperature settings to the half grill or full grill settings, depending on which you require.

To set the grill power, turn the grill control to any setting MIN - MAX.

After use always set the oven control back to '0' (Off).

COOLING FAN

A gentle flow of air will be blown below the control panel when any control is used. In some instances this will continue after switching off. This helps to keep the control panel and knobs cool.

The Controls (DE47 & DQ47)

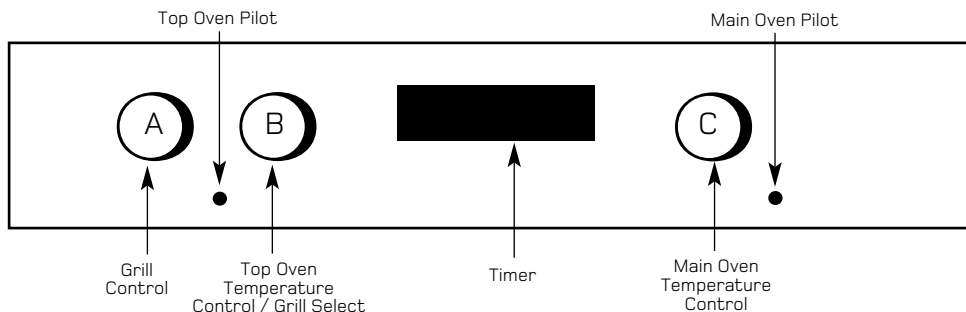

IMPORTANT

Before using your oven in the ordinary way, ALWAYS make sure that the timer has been set to **MANUAL** operation. Unless this is done, the main oven cannot heat up. Before seeking assistance, make sure this is done (refer to oven timer operation).

MAIN OVEN TEMPERATURE CONTROL

Turn the control clockwise to set the oven thermostat to the required temperature.

If the timer is set correctly an indicator light will illuminate. This will remain on until the oven reaches the required temperature. This light will then cycle on and off as the thermostat maintains control of the oven temperature.

TOP OVEN TEMPERATURE CONTROL

Turn the control clockwise to set the top oven thermostat to the required temperature. An indicator light will illuminate. This will remain on until the oven reaches the required temperature. This light will then cycle on and off as the thermostat maintains control of the oven thermostat.

GRILL CONTROL

The grill control is designed to provide variable heat control of either both grill elements on together or the single left-hand grill element only. Turn the top oven control clockwise past the temperature settings to the half grill or full grill settings, depending on which you require.

To set the grill power, turn the grill control to any setting MIN - MAX.

After use always set the oven control back to '0' (Off).

COOLING FAN

A gentle flow of air will be blown below the control panel when any control is used. In some instances this will continue after switching off. This helps to keep the control panel and knobs cool.

Multifunction Selector Switch (DE77 & DQ77)

The Multifunction selector switch is used when operating the main oven. With the exception of the 0 position the main oven light will remain on when this selector switch is used.

Off 

With the selector in this position the main oven will not heat up. The timer will still operate.

Fan Oven 

The oven fan and a rear element are controlled when this function is selected.

Use the main oven thermostat control to set the required temperature.

Conventional Oven 

Top and base elements are controlled when this function is selected.

Use the main oven thermostat to set the required temperature.

Half Grill 

With this function selected only the left hand side of the grill will be on.

Use the oven thermostat control to set the required temperature.

Oven door must be open for grilling.

Full Grill 

Both left and right hand grill elements will be on in this position. Use the oven thermostat control to set the required temperature.

Oven door must be open for grilling.

Fan Grill 

The oven fan and fan grill element are controlled when this function is selected.

Use the oven thermostat control to set the required temperature.

Oven door must be closed for fan grilling.

Fan Only 

The oven fan will operate when this function is selected.

The oven thermostat control must be set in the **off** position.

Light Only 

This function switches on the oven light only.

Oven Timer Operation

Note: Timer must be set to 'Time of Day' and 'Manual' before the ovens can be used.

AUTOMATIC COOKING

The Top Oven and Main Oven can be controlled by the automatic timer. When the timer control has been set for one oven, it is possible to use the other oven only during the same automatic cooking programme.

NEVER operate the grill when the ovens are set to cook automatically because the oven cavity can become warm and this may cause bacterial growth in food.

HINTS ON AUTOMATIC COOKING

1. Select foods which will require the same cooking time and temperature.
2. To ensure food does not cool down and require reheating, set the end time so the food is ready when you require it.
3. Always ensure that meat and poultry is defrosted before placing in the oven.
4. Whenever possible, take food out of the refrigerator and keep it as cool as possible.
5. If cooking food that requires frying before placing in the oven for auto cooking, keep the delay start time to a minimum.
6. Never place hot or warm food in the oven for delay start cooking as it could cause the oven to be warm and produce harmful bacteria in the food.
7. We advise that dishes containing left-over cooked poultry or meat, e.g. Shepherd's Pie, should not be cooked automatically if there is to be a delay period.
8. Ensure that delay start times are kept to a minimum to prevent bacterial growth in food.
9. Wine or beer may ferment and cream may curdle during the delay period so it is best to add these ingredients just before serving.
10. Foods which discolour should be protected by coating in fat or tossing in water to which lemon juice has been added, prior to placing food in the oven.
11. Dishes containing liquid should not be filled too full to prevent boiling over.
12. Food should be well sealed (but not airtight) in a container to prevent the loss of liquid during cooking. Aluminium foil gives a good seal.
13. Always ensure that food is piping hot and cooked thoroughly before serving.
14. Only reheat food once.

Know Your Timer

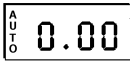

CLOCKFACE

The timer incorporates a 24 hour clock.

Ensure the correct time of day is always set, before using your cooker.

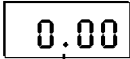

SYMBOLS

A 'bell' symbol will light up when you select a Minute Minder Period and will remain lit for the period set.

At the end of the Minute Minder Period, the timer will emit an audible tone and the 'bell' symbol will disappear.

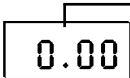

The 'cookpot' symbol will light up either:-

- When the timer is in manual mode, or
- During the actual Cook Period.

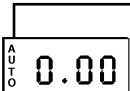

'AUTO' will light up:-

- When the timer is first turned on it will flash. It will go out when a time of day is set or when the timer is set to manual.

The 'AUTO' symbol will flash at the end of an Auto Cooking programme to indicate that the programme has finished.

(When the 'AUTO' symbol is flashing, to return the oven to Manual operation, turn the oven controls off, ensure that the correct time of day is set, and press the "Manual" button – The 'AUTO' symbol will go out.)



TIMER FUNCTION BUTTONS

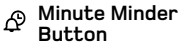

Minute Minder Button

Here you can set a time period of up to 23 hours 59 minutes, that will count down. When it reaches zero, the timer will emit an audible tone.

For Example: If you set 20 minutes, the audible tone will occur 20 minutes later.

AUTO COOKING PROGRAMME



Cook Period Button

Cook Period is the actual length of time for which, the timer will switch the oven(s) on as part of an "Auto Cooking" programme.

(e.g. If you set 2 hours, the food will be cooked for 2 hours).



End Time Button

The time of day at which you want an "Auto Cooking" programme to **end**.

For Example: If you set a "Cook Period" for 2 hours, and "End Time" of 11:00. The timer will switch the oven(s) on at 9:00 and turn the oven(s) off at 11:00. You will hear an audible tone at 11:00, to indicate that the Auto Cooking Programme has finished.

Notes:

- When setting an Auto Cooking programme you will need to set the oven control(s) to the required temperature(s) when you set the timer.
- If an Auto Cooking programme has been set the oven(s) will only operate during the pre-programmed time.



Manual Button

Needs to be pressed to cancel an Auto Cooking programme and return the oven(s) to Manual operation.

"+/-" Buttons

Used to adjust the various timer function settings.

Electronic Clock & Automatic Oven Timer Operation

SETTING THE TIME OF DAY

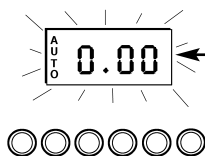

Step 1 Make sure all oven controls are turned Off.

Step 2 Check the electricity supply to the cooker is turned on.

Step 3 When switched on the display will show 0.00 and the Auto symbol, flashing intermittently.

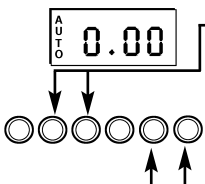

Step 4 Press & hold in both the Cook Period & End Time buttons together.

Step 5 With the Cook Period & End Time buttons still held in, press the "+" or "-" buttons to set the correct time of day.

Step 6 Release all the buttons simultaneously.

THE TIME OF DAY IS NOW SET.

To change the time of day repeat Steps 4, 5 & 6 above.

Note: You cannot adjust the time of day if the timer has been set for an Auto Cooking Programme.

SETTING THE MINUTE MINDER

Step 1 Ensure the time of day is set correctly.

Step 2 Press and hold the Minute Minder button.

Step 3 With the Minute Minder button held in, set the required Minute Minder period using the "+" and "-" buttons. A 'bell' symbol will light up.

Release all buttons and the timer display will revert back to the time of day. The 'bell' symbol will remain lit to signify that a Minute Minder period has been set.

At the end of the set time an audible tone will be heard, and the 'bell' symbol will disappear.

Step 4 To cancel the audible tone press the Minute Minder button.

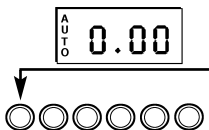
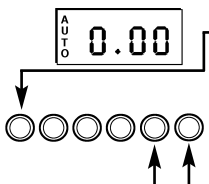

Note 1 When the Minute Minder has been set, the time remaining can be checked at any time by simply pressing the Minute Minder button.

Note 2 If necessary the Minute Minder can be cancelled before the tone sounds by pressing and holding the Minute Minder button and then at the same time pressing the "-" button until 0.00 appears in the display window.

Electronic Clock & Automatic Oven Timer Operation

AUTO COOKING PROGRAMMES

There are two Auto Cooking programmes that can be selected using your timer:-

- (a) To set the timer to switch the oven(s) On and Off Automatically
- (b) To set timer to switch on immediately and OFF automatically after a set cook period.

a) TO SET THE TIMER TO SWITCH THE OVEN(S) ON AND OFF AUTOMATICALLY

This allows you to cook at a specified time for a chosen period before the oven switches off Automatically.

- Step 1** Check that the correct time of day is set, if not follow instructions for setting the time of day.
- Step 2** Place food onto the correct shelf position in the oven and close the oven door(s).

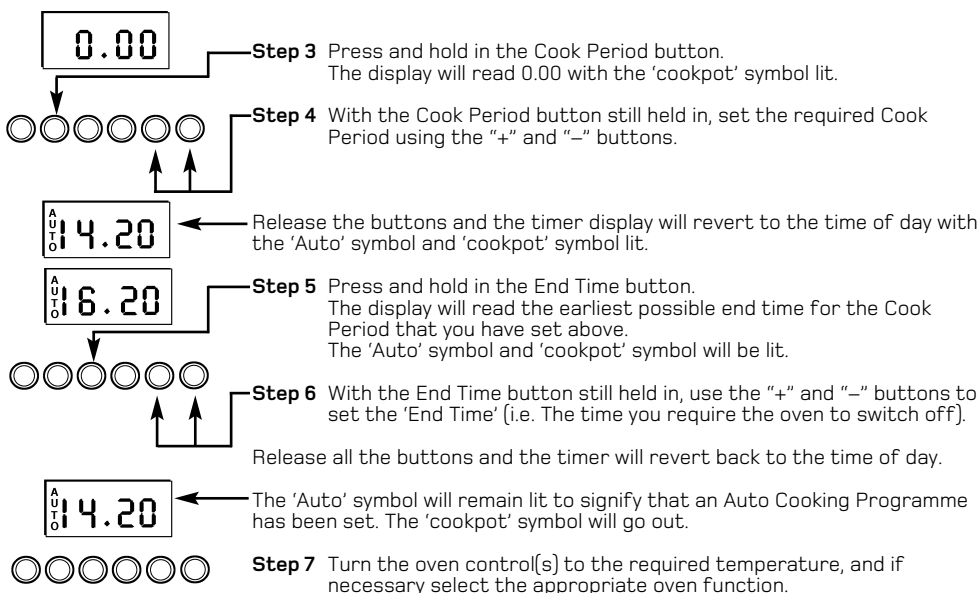

Note: If your appliance has two ovens: When the timer has been set for one oven it is possible to use the other oven only during the same Automatic programme.

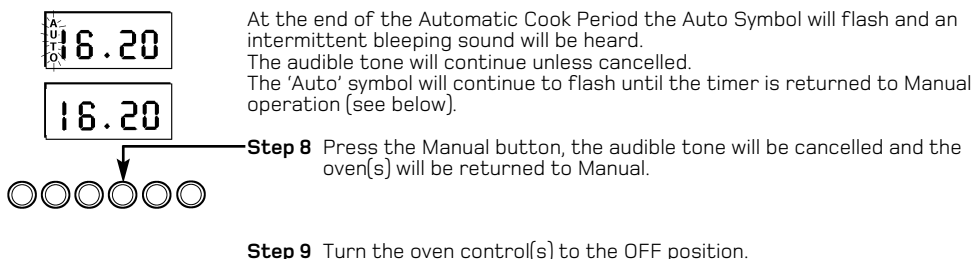

Electronic Clock & Automatic Oven Timer Operation

Note 1 When cooking automatically the Cook Period can be checked at any time by simply pressing the Cook Period button.

Note 2 When cooking automatically the End Time can be checked at any time by simply pressing the End Time button.

b) TO SET TIMER TO SWITCH ON IMMEDIATELY AND OFF AUTOMATICALLY AFTER A SET COOK PERIOD

- Step 1** Check that the correct time of day is set, if not follow instructions for setting the time of day.
Step 2 Place food onto the correct shelf position in the oven and close the oven door(s).
Step 3 Turn the oven control(s) to the required temperature, and if necessary select the appropriate oven function.

1.30

Step 4 Press & hold in the Cook Period button, the display will read 0.00 and the 'cookpot' symbol will light up.



With the Cook Period button still held in set the required Cook Period using the "+" and "-" buttons. Example: 1hr 30 minutes (as shown).

Note: Cook Period is the length of time the food requires to cook.

Step 5 Release all buttons.

AUTO
14.20

The timer display will revert to the time of day with the 'Auto' symbol lit & 'cookpot' symbol remaining lit.

NOTE:
The Cookpot symbol disappears

At the end of the Cook Period the 'Auto' symbol will flash and an intermittent audible tone will be heard. The audible tone will continue until cancelled. The 'Auto' symbol will continue to flash until the timer is returned to Manual operation (see below).

AUTO
16.20

Step 6 Press the Manual button. The audible tone will be cancelled and the oven(s) will be returned to Manual.

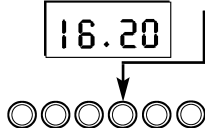

Step 7 Turn the oven control(s) to the OFF position.

Electronic Clock & Automatic Oven Timer Operation

TO CANCEL AN AUTO COOKING PROGRAMME BEFORE THE COOK PERIOD HAS FINISHED.

Step 1 Turn the oven control(s) to the OFF position.



15.00



Step 2 Press the Manual button to return the oven(s) to "Manual" operation. The 'Auto' symbol will go out.

Note 1 When cooking automatically the Cook Period can be checked at any time by simply pressing the Cook Period button.

OTHER NOTES ON TIMER OPERATION

1. When cooking Automatically the Cook Period can be checked at any time simply by pressing the Cook Period button.
2. When cooking Automatically the End Time can be checked at any time by simply pressing the End Time button.
3. Having set a Cook Period and End Time an electronic device stores the information. The device within the timer will switch the oven(s) on and off at the required times.
4. When setting an Auto Cooking Programme and a mistake is made, to clear:-
 - (d) Press & release the Manual button.
 - (e) Start the sequence again.
5. If at any time the display shows three flashing zero's 0.00 and 'Auto', it is likely that the electricity supply to the oven has been interrupted. Reset the timer to the correct time of day.
Food in the oven may, therefore, not have been cooked, before serving check food is thoroughly heated and completely cooked.
6. To set each function always press and hold the required function button and at the same time press the "+" and "-" buttons.

Grill Pan and Handle

The grill pan handle is detachable from the pan, to facilitate cleaning and storage. The grill pan handle can be fixed as follows:

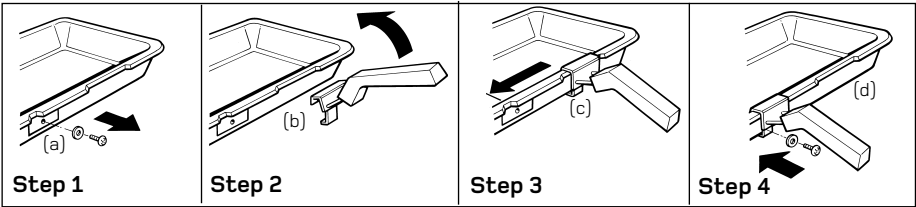

- Step 1** Remove the screw and washers from the grill pan bracket (a).
 - Step 2** Tilt the handle over the recess (b).
 - Step 3** Slide it towards the centre of the pan (c).
 - Step 4** Locate the handle over the bracket (d).
- For a fixed handle, replace the screw and washers and ensure they are fully tightened up. If a detachable handle is required, do not replace the screw and washers.

Note: If a fixed handle is required, the grill pan cannot be kept in the main oven with the door closed but may be stored in the top oven with the door closed, when the top oven is not in use.

Grill Pan, Food Support and Anti-Splash Tray

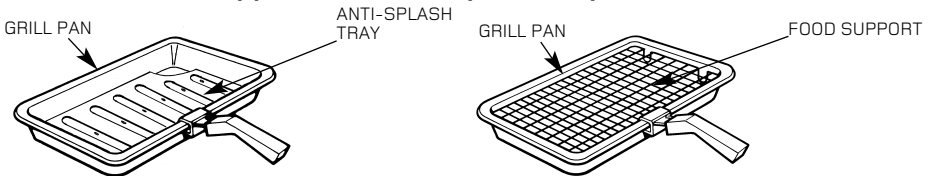

Note: To stop fat splashing onto the grill mesh, it is important to use the anti-splash tray as shown in the grilling chart. Always clean the grill pan, anti-splash tray and food support after each use.

Top Oven Shelf Positioning for Grilling

ENSURE SHELVES ARE FITTED CORRECT WAY UP.

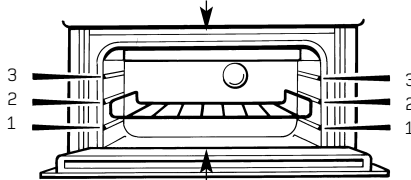

DO NOT PLACE FOOD/UTENSILS DIRECTLY ON THE OVEN FLOOR

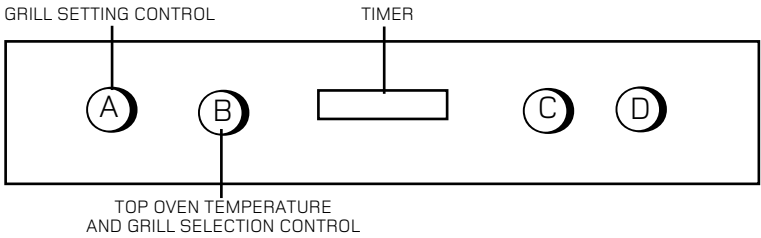

NOTE: Preheat the grill if indicated on grill chart. The grill pan must be placed on the correct shelf and positioned centrally under the grill element. Leave the control at MAX for toast, and for fast cooking of foods. For thicker foods requiring longer cooking, turn the switch to a lower setting after the initial sealing on both sides at MAX. The thicker the food, the lower the control should be set. DO NOT line the grill pan with aluminium foil, as this increases the amount of fat spitting which can cause a fire. After use always return both controls to their OFF (0) position.

Operation when using the Top Oven for Grilling



Step 1 Ensure oven timer is set to manual.
Place the shelf in the correct position (see Grilling Guide).
Place the food/grill pan on the shelf, positioned centrally under the grill element.
Leave the top oven door fully open.

Step 2 Turn knob (B) clockwise to select grill function setting:

Set to:  For Half Grill (Left hand side only).
 For Full Grill.

NOTE: As you turn past the end of the oven temperature scale you will feel resistance on the knob – continue turning clockwise until the grill setting position is selected.

Step 3 Turn knob (A) clockwise to select the Grill Setting (MIN–MAX).
(MIN=Low, MAX=High).

Grill Controls Example:

 = Full Grill Function

 = High Grill Setting

NOTE: Do not grill with the grill/top oven door closed.

Step 4 After use, turn both controls A & B anti clockwise to their off (0) position.

DOOR POSITION FOR GRILLING.

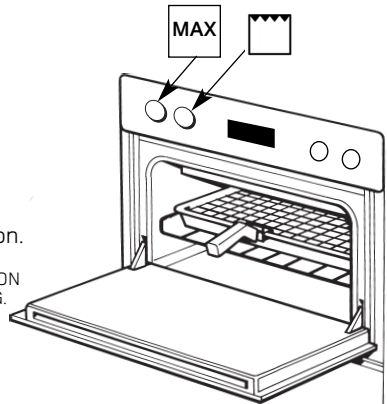

DO NOT allow young children near to the appliance when the grill is in use as the surfaces get extremely hot.

Using the Top Oven for Solarplus Grilling

Your cooker is not fitted with a conventional grill. Hotpoint have developed a Solarplus high speed grill which is designed to reduce your grilling times. It is quicker because it takes less time to warm up from cold. Conventional grills require 5 minutes pre-heat before food can be placed beneath them, but for normal grilling the Solarplus grill can be used directly from cold without any pre-heat. However, when toasting, optimum performance is achieved by pre-heating the grill for about 1 minute.

NOTE: You will notice that the grill elements are protected by a wire mesh. This stops you from touching live parts.

DO NOT under any circumstances insert objects into the grill mesh as this could damage the element wire, break the glass tubes or if the grill is on, cause electric shock.

During use, the wire mesh may become soiled. DO NOT attempt to clean it while the grill is still on. Turn off at the control and allow to cool before cleaning. Care must be taken to ensure the grill mesh is not distorted - do not store the grill pan handle on the food grid when the shelf is in the highest position.

IMPORTANT:

Grilling should never be undertaken with the grill/top oven door closed.

Guide to Solarplus Grilling

FOOD	PREHEAT FOR ONE MINUTE	SHELF POSITION FROM THE BASE OF THE OVEN	SETTING	APPROXIMATE COOKING TIME	PAN TO BE USED
Toasting of Bread Products	Setting MAX	3 or 2	Setting MAX	3 - 5 minutes	Grill pan and food support
Small cuts of meat, Sausage, Bacon	None	3 or 2	Setting MAX for 4 minutes then reduce to lower Setting	10 - 15 minutes	Grill pan, anti-splash tray and food support
Chops etc. Gammon steaks	None	2	Setting MAX for 6-8 minutes then reduce to lower Setting	25 - 30 minutes	Grill pan, anti-splash tray and food support
Fish: Whole Fillets Fingers	None None None	2 3 3	Setting MAX	6 - 8 minutes 10 - 15 minutes 10 - 15 minutes	Grill pan and food support
Pre-cooked potato products	None	3 or 2	Setting between MEDIUM and MAX position	10 - 12 minutes	Grill pan and food support
Pizzas	None	3 or 2	Setting between MEDIUM and MAX position	10 - 12 minutes	Grill pan and food support
Browning of food eg. Cauliflower Cheese	Setting MAX	3 or 2	Setting MAX	5 - 10 minutes	Dish placed directly on the shelf

Using the Top Oven as a Convection Oven

The top oven should be used to cook small quantities of food. The oven is designed so that the grill element operates at a reduced heat output, this is combined with a heating element situated underneath the floor of the oven. To ensure even cooking of the food it is important that cooking utensils are positioned correctly on the oven shelf so that the element is directly above. As a guide, the front of the utensil should be approx.100mm (4") from the front of the shelf.

Note: Charts are a guide only, to suit personal taste and requirements, it may be necessary to increase or decrease temperatures by 10°C. It may also be necessary to increase or decrease cooking times.

SHELF POSITIONING

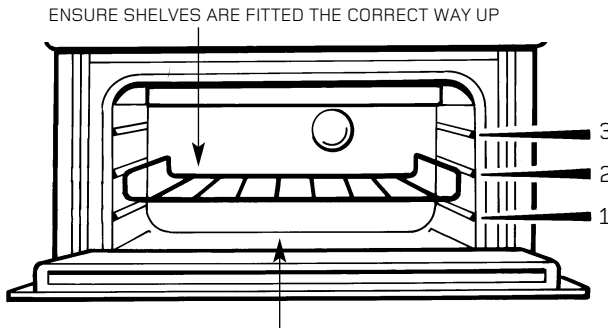

DO NOT PLACE FOOD/UTENSILS DIRECTLY ON THE OVEN FLOOR

There should always be at least 25mm (1 inch) between the top of the food and the grill element.

WARNING: Items stored in the top oven will get hot when the main oven is in use.

DO NOT allow young children near to the appliance when the top oven is in use as the surfaces get extremely hot.

Operation when using the Top Oven as a Convection Oven

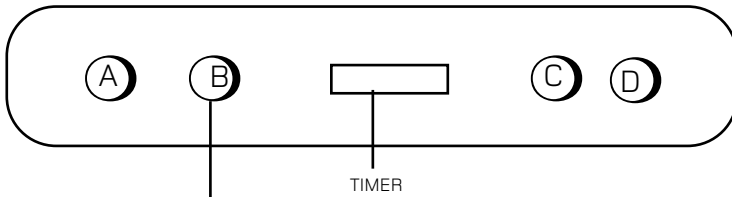

TOP OVEN TEMPERATURE & GRILL SELECTION CONTROL

Step 1 Check that the timer is in manual.

Step 2 Place the shelf in the correct position (see Oven Temperature Charts).

Step 3 Select the required cooking temperature (100°C-MAX) using control (B) (see Top Oven Temperature Charts).

The pilot light (●) will immediately come on, and remain on until the oven reaches the required temperature. The light will then automatically go off and on during cooking as the oven thermostat maintains the correct temperature.

Step 4 Place the food on the shelf directly below the element ensuring the oven door is closed.

NOTE: At the end of your cooking, always return control (B) to the OFF (0) position.

PLATE WARMING

Place the plates/dishes on shelf position 1 from the base of the top oven, and turn top oven temperature and grill selection control (B) to 100°C for 10-15 minutes.

Never use the grill setting control (A) when warming plates.

TOP OVEN UTENSILS

Do Not use: Meat Pans and Baking Trays larger than – 225mm x 300mm (9"x12")

DO NOT use the grill pan or main oven meat pan as a meat pan in the top oven, as the air circulation will be seriously restricted.

Oven Temperature Charts – Baking

Baking	Top Oven Cooking				Fan Oven Cooking		
	Pre-heat	Temperature °C	Time in mins.	Position in Oven	Pre-heat	Temperature °C	Time
Scones	Yes	210/220	10-15	Runner 1 from bottom of oven.	Yes	210/220	9-12
Small Cakes	Yes	180/190	20-25	Runner 1 from bottom of oven.		170/180	15-20
Victoria Sandwich	Yes	170/180	20-30	Runner 1.		160/170	20-25
Sponge Sandwich (fatless)	Yes	180/190	20-25	Runner 1 from bottom of oven.	Yes	170/190	15-20
Swiss Roll	Yes	200/210	10-15	Runner 1 from bottom of oven.	Yes	180/200	12-15
Semi-rich Fruit cakes	Yes	150/160	60-75 7 inch	Runner 1.		140/150	1 1/4 - 1 1/2 hrs
Rich Fruit Cakes	Yes	140/150	Time Dependent on size	Runner 1.		130/140	Depending on size
Shortcrust Pastry	Yes	190/200	Time Dependent on recipe	Runner 1 from bottom of oven.		190/200	Depending on size
Puff Pastry	Yes	200/210	Time Dependent on recipe	Runner 1 from bottom of oven.		190/200	Dependent on size
Yorkshire Pudding	Yes	190/200	30-40	Runner 2 from bottom of oven.	Yes	180/190	40-45
Individual Yorkshire Puddings	Yes	200/210	20-30	Runner 2 from bottom of oven.	Yes	190/200	20-25
Milk Pudding	Yes	140/150	90-120	Runner 1.		130/140	1 1/2 - 2 hrs
Baked Custard	Yes	150/160	40-50	Runner 1.		140/150	35-45
Bread	Yes	200/210	30-45	Runner 1.	Yes	200/210	30-35
Meringues	Yes	100	150-180	Runner 2 from bottom of oven.	No	80-90	3 - 4 hrs

Note: if soft margarine is used for cake making, temperatures recommended by the manufacturers should be followed. Temperatures recommended in this chart refer to cakes made with block margarine only.

Oven Temperature Charts – Meat

Meat		Top Oven Cooking			Fan Oven Cooking			
Meat	Pre-heat	Temperature °C	Time (approx.)	Position in Oven	Meat	Pre-heat	Temperature °C	Time (approx.)
Beef/ Lamb (slow roasting)	Yes	170/180	35 mins per 450g (1 lb) + 35 mins over.	Runner 1 from bottom of oven.	Beef	No	160/180	20-25 mins per 450g (1lb) + 20 mins extra
Beef/ Lamb (foil covered)	Yes	190/200	35-40 mins per 450g (1 lb)		Lamb	No	160/180	20-30 mins per 450g (1lb) + 25 mins extra
Pork (slow roasting)	Yes	170/180	40 mins per 450g (1 lb) + 40 mins over		Pork	No	160/180	25-30 mins per 450g (1lb) + 25 mins extra
Pork (foil covered)	Yes	190/200	40 mins per 450g (1 lb)		Veal	No	160/170	25-30 mins per 450g (1lb) + 25 mins extra
Veal (slow roasting)	Yes	170/180	40-45 mins per 450g (1 lb) + 40 mins over		Chicken/ Turkey up to 4kg (8 lb)	No	160/180	18-20 mins per 450g (1lb) + 20 mins extra
Veal (foil covered)	Yes	190/200	40-45 mins per 450g (1 lb)		Turkey 4 to 5.5kg (8 to 12 lb)	No	150/160	13-15 mins per 450g (1 lb) at 150/160°C allow 12 mins per 450g at 150°C
Poultry/Game (slow roasting)	Yes	170/180	25-30 mins per 450g (1 lb) + 25 mins over		Casserole Stews	No	140-150	1 1/2 - 2 hrs
Poultry/Game (foil covered)	Yes	190/200	25-30 mins per 450g (1 lb)					
Casserole Cooking	Yes	150	2-2 1/2 hrs					

If using aluminium foil, never: **1.** Allow foil to touch sides of oven. **2.** Cover oven interior with foil. **3.** Cover shelves with foil.

The most accurate method of testing the readiness of joints of meat or whole poultry is to insert a meat thermometer into the thickest part of a joint, or the thickest part of poultry thighs, during the cooking period. The meat thermometer will indicate when the required internal temp has been reached.

Beef –	Rare:	60°C	Lamb:	80°C	Poultry:	90°C
	Medium:	70°C	Pork:	90°C		
	Well Done:	75°C	Veal:	75°C		

Main Oven – Fan Grilling (DE77 & DQ77)

Fan grilling is a combination of heat from the grill element and the oven fan circulating the hot air around the food.

Joints of meat and poultry will be browned as if they were cooked on a rotisserie or spit but more economically as the door left closed.

If required, fan grilling can be timed using the Oven Auto timer. Follow the timer instructions before selecting fan grill and the required temperature.

If Manual fan grilling is required always ensure the timer is set to Manual.

Do not use the oven without the removable oven roof in position with its front flange facing downwards.

Operating Instruction

1. Open the oven door.
2. Select the correct shelf position, as stated in chart.
3. Turn the selector switch to the Fan grill  position.
4. Turn the oven thermostat control to the required temperature (see Fan Grilling Roasting Chart).
5. Position the meat pan centrally under the grill elements.
6. Close the oven door.
7. After use always return both controls to the off position.
8. If the oven timer was used, reset to Manual.

As with the fan oven cooking there is no need to pre-heat the oven – yet another economy feature. Also you can cook more than one thing at a time – even up to 4 small chickens.

Temperatures

These will be similar to those used for the more traditional form of roasting but the guide will give you an indication of which temperature to set the Thermostat. But remember that because of the way the oven is heated this is a more economical way of roasting.

General Recommendations

Most types of meat and poultry cooked by this method will have an all over brownness and crispness on the outside. The only exceptions are very lean joints, such as veal, which, because of its low fat content, is better cooked using conventional heating.

1. Always place the pan on the shelf position recommended. (See Chart).
2. There is no need to preheat the oven before cooking and all fan grilling should be carried out with the oven door closed, this saves energy.
The cooking temperatures and times are calculated from a cold oven.
3. After rinsing and drying meat, place on the food roasting support rack over the pan supplied.
4. Position meat in oven as recommended in the roasting chart.
5. Fan grilling is ideally suited for cooking all types of poultry and larger joints of meat (e.g. stuffed, rolled joints and legs of pork and lamb). Results will be as if you had cooked the food on a rotisserie. If you use frozen meat or poultry it must be completely defrosted before it is cooked.
6. When cooking a joint always grill it with the fat side uppermost in order to crisp it. For bigger joints or where there is little bone, grill at the lower temperature given in the table and cook for a longer time per kg.
7. When cooking any type of poultry, start grilling the underside uppermost and turn breast uppermost about a third to halfway through the cooking period. If cooking stuffed poultry allow slightly longer cooking time.

Meat pan and roasting rack

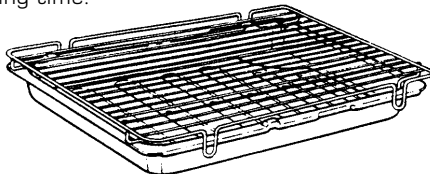

Main Oven – Fan Grilling Roasting Chart (DE77 & DQ77)

Shelf positions are counted from the base upwards ie: lowest shelf position is 1.

Type of Meat or Poultry	Weight kg	Temp °C	Time (min/kg)	Plus Extra Time (mins)	Total Cooking Time (mins)	Tips
PORK Pork Chop - thick		170	25		Dependent on size	Season. Grill on shelf position 3. Turn over after 15 mins.
Gammon Steaks		160	30		Dependent on size	Grill on shelf position 3 Turn after 15 mins.
Pork - any type of joint	1.0 1.5 2.0 2.5 over 2.5	160-170 150-170 140-150 140-150 140	60-70 60-70 65-75 65-75 70-75	45 45 50 50 50	105-120 130-150 180-230 220-240 -	Score fat with sharp knife and rub on salt. Pork should always be thoroughly cooked. So overcook rather than undercook. Grill on shelf position 1.
LAMB Lamb chop - thick		170	25		Dependent on size	Season. Grill on shelf position 3. Turn over after 15 mins.
Lamb - any type of joint	1.0 1.5 2.0 2.5 over 2.5	160-170 160-170 150-160 150-160 150	30-40 35-40 35-45 40-45 45-50	45 45 50 50 50	78-88 90-110 120-140 150-170 -	Score fat. Season with pepper and rosemary. If you prefer the lamb pink choose the shorter time Grill on shelf position 1.
BEEF Beef - joints which have an outside layer of fat eg. Rib, Rolled, Sirloin	1.0 1.5 2.0 2.5 over 2.5	170-180 170-180 160-170 160-170 160	40-50 40-50 40-50 45-50 45-50	20 20 20 30 40	60-70 80-90 100-110 140-150 -	Season. If joint preferred rare grill for the shorter time. If preferred well done grill for the longer time. Grill on shelf position 1.
CHICKEN	1.0 1.5 2.0 2.5 over 2.5	180 180 170 170 160-170	30 30 35 35 40	30 30 30 30 30	60 75 100 115 -	Season and brush over with melted butter to give nicely browned skin. Grill on shelf position 1.
Chicken joints	less than 1kg each	180	30	30	60	Shelf 1.
DUCK	1.5 2.0 2.5	180 180 180	30 30 35	30 30 30	75 90 115-130	Dry thoroughly and lightly salt. Grill on shelf position 1.
GOOSE	up to 4 4-5	170-190 160-170	40 45	40 40	- -	Can be stuffed. Grill on shelf position 1
TURKEY	up to 5 6-8	170 150	- -	- -	150-165 165-175	Season and brush over with melted butter to give nicely browned skin. Grill on shelf position 1
GAME Grouse Partridge Pheasant	Any Any Any	170-180 170-180 170-180	30-50 40-50 40-50	- - -	- - -	Well hung meat will require less cooking time. grill on position 1.
Beefburgers	450g(lb)	170	25mins per 450g (lb)			Shelf 3.
Sausages	450g (lb)	170	25mins per 450g (lb)			Shelf 3. Prick sausages before cooking.
Bacon	450g (lb)	170	25mins per 450g (lb)			Shelf 3. Roll up bacon before cooking.
Mixed Grill		170			30	4 pieces of steak, sausages, chops, bacon, tomatoes & mushrooms. Cook sausages, chops, bacon for 10 mins. add steak, cook for further 20 mins.

Using the Main Oven for Other Functions



FAN ONLY SETTING

DEFROSTING FROZEN MEAT & POULTRY

Joints of meat and whole birds should be defrosted slowly, preferably in a refrigerator (allowing 5-6 hours per lb.) or at room temperature (allowing 2-3 hours per lb.).

Frozen meat or poultry must be completely defrosted before cooking in the oven.

However, to decrease the amount of time required to defrost food items, a non-heating fan only setting may be selected for the main oven only.

OPERATION: TO ASSIST IN DEFROSTING:

Place food in the oven and close the oven door.

(DE77 & DQ77) - Turn the Multifunction Control (D) clockwise to the  setting.

(DE47 & DQ47) - Turn the Main Oven Control (C) clockwise to the  setting.

This defrosts by circulating the air around the food, time to defrost will depend on type and size of the food.

NOTES: DO NOT defrost meat and poultry by warming the food through.

Foods ideally suited to defrosting using the fan only setting are cream/cream cakes, butter cream filled cakes, gateaux, cheese cakes, iced cakes, quiches, pastries, biscuits, bread, croissants, fruit and many delicate frozen foods.

If fish, meat and poultry are to be defrosted using the fan only setting, where possible it is recommended that the food should be small & thin.

The items should be placed so that the maximum amount of surface area is exposed to the circulating air, and that they are turned regularly to ensure even defrosting.

Larger cuts of meat and poultry may be defrosted by using the fan only setting up to a maximum weight of 2 kg (4lb 8oz).

It is important to wash both meat and poultry and cooking utensils immediately after defrosting and before cooking. Food should be cooked immediately after

It is very important to strictly adhere to the basic principles of food handling and hygiene to prevent the possibility of bacterial growth.



LIGHT ONLY SETTING

(DE77 & DQ77) - When the Multifunction Control (D) is turned clockwise to the  setting, the main oven light only will illuminate.

(DE47 & DQ47) - When the Main Oven Control (C) is turned clockwise to the  setting, the main oven light only will illuminate.

Main Oven – Conventional Oven (DE77 & DQ77)

Important

NEVER line the shelves, the floor or the sides of the oven with aluminium foil as overheating and damage may result.

The oven is heated by elements at the top of the oven and underneath the floor of the oven.

Food should not be placed on the floor of the oven.

Do not use the oven without the removable oven roof in position with its front flange facing downwards.

Operating Procedure

1. Ensure Oven Timer is set to Manual.
2. Position rod shelf as recommended in the chart for food being cooked.
3. Position food centrally under grill element.
4. Turn the selector switch to the conventional oven position. 
5. Turn the oven thermostat control to the required temperature setting (see oven temperature charts).
The oven light will remain on.
The oven indicator light will remain on until the oven reaches the set temperature.
This light will then automatically cycle on and off during cooking as the oven temperature is controlled.
6. After use always return both controls to the off position and close the oven door.

Main Oven – Fan Oven (all Models)

Important

NEVER line the shelves, the floor or the sides of the oven with aluminium foil as overheating and damage may result.

The oven is heated by elements at the rear of the oven.

A fan at the rear of the oven operates to circulate heated air within the oven.

Do not use the oven without the removable oven roof in position with its front flange facing downwards.

Operating Procedure

1. Ensure Oven Timer is set to Manual.
 - 2a. (DE77 & DQ77)
 - Turn the selector switch to the fan oven position .
 - Turn the oven thermostat control to the required temperature setting (see oven temperature charts).
 - 2b. (DE47 & DQ47)
 - Turn the oven thermostat control to the required temperature setting (see oven temperature charts).
3. The oven light will remain on.
The oven indicator light will remain on until the oven reaches the set temperature.
This light will then automatically cycle on and off during cooking as the oven temperature is controlled.
4. After use always return all controls to the off position and close the oven door.

Main Oven – Fan Oven Cookery Notes

Since a fan oven heats up more quickly, and generally cooks food at a lower temperature than a conventional oven, pre-heating the oven is often unnecessary. However, foods such as bread, scones, Yorkshire pudding, do benefit from being placed in a pre-heated oven.

The charts are a guide only, giving approximate cooking temperatures and times. To suit personal taste and requirements, it may be necessary to increase or decrease temperatures by 10°C.

Because the fan oven cooks so efficiently, we recommend that when cooking any recipes not designed for a fan oven, you reduce the temperature by about 25°C and the time by about 10 minutes in the hour. If large quantities are being cooked it will be necessary to increase the cooking time somewhat to compensate for the extra oven load.

Unless otherwise indicated in the charts, food is placed in a cold oven, i.e. without pre-heating. If food is placed in an already hot oven, the suggested cooking time should be reduced, depending on the type and quantity of food being cooked.

It should be noted that at the end of a cooking period there may be a momentary puff of steam when the oven door is opened, this will disperse in a few seconds and is a perfectly normal characteristic of an oven with a good door seal.

Oven Positions

Since the distribution of heat in the fan oven is very even, most foods will cook satisfactorily on any shelf position, but the shelves should be evenly spaced:

To ensure even circulation do not use meat pans larger than 390x300mm (15ins x 12ins) and baking trays no larger than 330 x 255mm (13ins x 10ins), these should be positioned centrally on the oven shelf.

- Do not fit shelves upside down.
- Never use more than 3 shelves in the oven as air circulation will be restricted.
- Food or cooking utensils should not be placed on the floor of the oven.

To avoid unnecessary cleaning, rod shelves which are not in use should be removed from the oven.

Main Oven – Fan Oven Cookery Notes

Temperature and Time

The oven is provided with two shelves. A third is available as an optional extra, contact Genuine Parts & Accessories Hotline (see back page) for further information.

If three shelves are used to cook large quantities of food for home freezing or parties, it may be necessary to increase the cooking times given in the charts by a few minutes, to allow for the loss of heat due to the extra time taken to load the oven, and the larger mass of food.

Baking trays should allow an equal gap on all sides of the oven.

To prepare meat and poultry for Roasting in your Fan Oven

- (a) Wipe the meat or poultry, dry well and weigh it. Meat which has for been stored in a refrigerator should be allowed to come to room temperature before cooking, and frozen meat or poultry must be completely defrosted before placing in the oven.
- (b) The weight of any stuffing used should be added before calculating the cooking time.
- (c) Place meat/poultry in the main oven meat pan supplied with your cooker. Small joints weighing less than 1.75kg (3¹/₂ lbs) should be roasted in a smaller meat pan/tin – or they may be 'pot roasted' – a small joint or a large meat pan causes unnecessary oven splashing and evaporation of meat juices.
- (d) Additional fat should not be added, except for veal, very lean meat or poultry which can either be 'larded' with fat bacon or brushed very sparingly with cooking oil or melted fat.
- (e) Beef, lamb, mutton and poultry may be dusted lightly with seasoned flour to give a crisp outer surface. The skin of duck and goose should be pricked to release excess fat during cooking, and the rind of pork should be scored, brushed lightly with oil, and rubbed with salt to give crisp crackling.
- (f) Meat and poultry wrapped in, or covered with a tent of aluminium foil will be juicy and tender. Roasting bags offer the same advantages. Always follow the manufacturer's pack instructions, and remember to reduce the temperatures given for conventional ovens by approximately 25°C and the time by approximately 10 minutes per hour.
- (g) Potatoes for roasting only require to be brushed with cooking oil or melted fat.
- (h) It is not necessary to baste when roasting in an electric oven and stock or liquid should not be added to the meat pan since this only causes unnecessary soiling, steam and condensation.

Frozen Meat and Poultry

Joints of meat and whole birds should be defrosted slowly, preferably in a domestic refrigerator (allowing 5-6 hours per 450g, 1 lb), or at room temperature (allowing 2-3 hours per 450g, 1 lb).

Frozen meat or poultry must be completely defrosted before placing in the oven.

It is essential to wash thoroughly and cook meat and poultry immediately after defrosting.

Main Oven Temperature Chart

It is not necessary to pre-heat the fan oven before roasting. Note: Where times are stated, they are approximate only.

Conventional Oven (DE776 DQ77)				Fan Oven				
Meat	Pre-heat	Temperature °C	Time (approx.)	Position in Oven	Meat	Pre-heat	Temperature °C	Time (approx.)
Beef/ Lamb (slow roasting)	Yes	170/180	35 mins per 450g (1 lb) + 35 mins over.		Beef	No	160/180	20-25 mins per 450g (1lb) + 20 mins extra
Beef/ Lamb (foil covered)	Yes	190/200	35-45 mins per 450g (1 lb)		Lamb	No	160/180	20-30 mins per 450g (1lb) + 25 mins extra
Pork (slow roasting)	Yes	170/180	40 mins per 450g (1 lb) + 40 mins over		Pork	No	160/180	25-30 mins per 450g (1lb) + 25 mins extra
Pork (foil covered)	Yes	190/200	40 mins per 450g (1 lb)		Veal	No	160/170	25-30 mins per 450g (1lb) + 25 mins extra
Veal (slow roasting)	Yes	170/180	40-45 mins per 450g (1 lb) + 40 mins over	Runner 3 from bottom of oven.	Chicken/ Turkey up to 4kg (8 lb)	No	160/180	18-20 mins per 450g (1lb) + 20 mins extra
Veal (foil covered)	Yes	190/200	40-45 mins per 450g (1 lb)		Turkey 4 to 5.5kg (8 to 12 lb)	No	150-160 or 150	12-14 mins per 450g (1lb) at plus 12 mins extra for every 450g (1lb) over 5.5kg (12lb) allow 10 mins per 450g (1lb) and roast at 150 C
Poultry/Game (slow roasting)	Yes	170/180	25-30 mins per 450g (1 lb) + 25 mins over		Casserole Stews	No	140-150	1 1/2 - 2 Hrs
Poultry/Game (foil covered)	Yes	190/200	25-30 mins per 450g (1 lb)					
Casserole Cooking	Yes	150	2-2 1/2 hrs					

If using aluminium foil, never: **1.** Allow foil to touch sides of oven. **2.** Cover oven interior with foil. **3.** Cover shelves with foil.

The most accurate method of testing the readiness of joints of meat or whole poultry is to insert a meat thermometer into the thickest part of a joint, or the thickest part of poultry thighs, during the cooking period. The meat thermometer will indicate when the required internal temp has been reached.

Beef -	Rare:	60°C	Lamb:	80°C	Poultry:	90°C
	Medium:	70°C	Pork:	90°C		
	Well Done:	75°C	Veal:	75°C		

Main Oven Temperature Chart

Note: Where times are stated, they are approximate only.

Baking	Conventional Oven (DE77 & DQ77)				Fan Oven		
	Pre-heat	Temperature °C	Time	Shelf Position	Pre-heat	Temperature °C	Time
Scones	Yes	220	10-15 mins.	2nd from bottom	Yes	210/220	9-12 mins. approx.
Small Cakes	Yes	180	15-25 mins.	3rd from bottom	No	170/180	15-20 mins. approx.
Victoria Sandwich	Yes	160	20-30 mins.	3rd from bottom	No	160/170	20-25 mins. approx.
Sponge Sandwich (Fattish)	Yes	170/180	15-20 mins.	3rd from bottom	Yes	170/190	15-20 mins. approx.
Swiss Roll	Yes	190/200	8-12 mins.	3rd from bottom	Yes	180/200	12-15 mins approx.
Semi-rich Fruit cakes	Yes	150/160	1 1/4 hrs. 7"	2nd from bottom	No	140/150	1 1/4 - 1 1/2 hrs. approx.
Rich Fruit Cakes	Yes	130/140	Depending on recipe and size	2nd or 3rd from bottom	No	130/140	Depending on size.
Shortcrust Pastry	Yes	180/190	Depending on use	2nd or 3rd from bottom	No	190/200	Depending on size.
Puff Pastry	Yes	190/200	Depending on use	2nd or 3rd from bottom	No	190/200	Depending on size
Yorkshire Pudding	Yes	190/200	40-45 mins.	3rd from bottom	Yes	180/190	40-50 mins. approx.
Individual Yorkshire Puddings	Yes	200/210	20-30 mins.	3rd from bottom	Yes	190/200	20-25 mins. approx.
Milk Pudding	Yes	140/150	1 3/4 - 2 hrs.	2nd from bottom	No	130/140	1 1/2 - 2 hrs. approx.
Baked Custard	Yes	130/140	40-50 mins.	3rd from bottom	No	140/150	35-45 mins. approx.
Bread	Yes	190/200	25-35 mins.	3rd from bottom	Yes	200/210	30-35 mins. approx.
Meringues	Yes	80/90	3 - 3 1/2 hrs.	3rd from bottom	No	80-90	3-4 hrs. approx.

Note: If soft-tub margarine is used for cake making, we would recommend using the all-in-one method and to reduce the temperature by 10°C. Temperatures recommended in this chart refer to cakes made with block margarine or butter only.

Main Oven – Circulaire Roasting (DE77 & DQ77)

CIRCULAIRE ROASTING

Circulaire roasting - food is placed on the roasting rack, this allows the oven fan to circulate the hot air around the food, making it suitable for thin foods, such as chops, steaks, sausages as well as meat joints and poultry, as it will cook both sides at the same time. It is possible to cook on any shelf position, as the temperature in the oven is evenly distributed. Also, the oven heats up more quickly and generally will cook food at a lower temperature than a conventional oven, so pre-heating is not necessary for most foods. For a guide on "cooking times" and "cooking temperatures" see "Circulaire Roasting Chart". If required, circulaire roasting can be timed using the Oven Timer. Follow the timer instructions before selecting Fan Oven function and the required temperature.

Note: It is also possible to cook food on the roasting rack on one shelf, while cooking different types of food at the same temperature, on other shelf positions (three shelves maximum).

Operating Instructions:

- STEP 1. Ensure the Oven Timer is set to manual.
Ensure that the oven shelf is in the position you require.
Place the food centrally on the roasting rack.
Position the roasting rack on top of the grill/meat pan.
Place the grill/meat pan centrally on the oven shelf.
Ensure the oven door is fully closed.
- STEP 2. Turn the control knob (D) clockwise to the fan oven function. 
Turn the control knob (C) clockwise and select the required cooking temperature. The pilot light (●) will immediately come on and will remain on until the oven reaches the required temperature. The light will then automatically go off and on during cooking as the oven thermostat maintains the correct temperature.
- STEP 3. After use, turn controls (C) and (D) to the Off (O) position.

Note: At the end of a cooking period there may be a momentary puff of steam when the door is opened. This will disperse in a few seconds and is a perfectly normal characteristic of an oven with a good door seal.

Main Oven – Circulaire Roasting Chart (DE77 & DQ77)

Type of Meat & Poultry	Temperature °C	Time (approximate)	PLACE FOOD ON ROASTING RACK, THEN POSITION ABOVE THE MEAT PAN.
BEEF Beef - any type of joint	160/180	20-25 minutes per 450g (1lb) + 20 minutes extra	
PORK Pork - any type of joint	160/180	25 minutes per 450g (1lb) + 25 minutes extra	
Pork - Chops	170	30-45 minutes	
LAMB Lamb - any type of joint	160/180	25 minutes per 450g (1lb) + 25 minutes extra	
Lamb - Chops	170	20-30 minutes	
CHICKEN/TURKEY up to 4kg (8lb)	160/180	18-20 minutes per 450g (1lb) + 20 minutes extra	
STEAKS	170	30-45 minutes	
GAMMON STEAKS	170	30-45 minutes	
SAUSAGES	170	30-45 minutes	

Note: The above chart is only a guideline. The times and temperatures may be increased or decreased depending on personal taste.

Using the Main Oven for Other Functions

'S' SLOW COOK SETTING

This is used for slow cooking, keeping food warm and warming plates for short periods. Extra care should be taken when warming bone china, as it may be damaged in a hot oven.

DO NOT place food or plates directly on the oven floor as this could damage both the oven lining and the plates which are being warmed.

ADVANTAGES OF SLOW COOKING ARE:

The oven stays cleaner because there is less splashing.
Timing of food is not as critical, so there is less fear of overcooking.
Inexpensive joints of meat are tenderised.
Fully loading the oven can be economical.
Cooking times can be extended in some cases by up to 2 hours.

OPERATION:

(for models DE77 & DQ77):

1. Place the prepared food in the main oven and ensure the door is fully closed.
2. Select Slow Cooking Temperature 'S' by turning the Main Oven Temperature Control (C) & Function Control (D) clockwise to Fan Oven mode.

(for models DE47 & DQ47):

1. Place the prepared food in the main oven and ensure the door is fully closed.
2. Select Slow Cooking Temperature 'S' by turning Main Oven Temperature Control (C).

STORAGE & RE-HEATING OF FOOD:

1. If food is to be frozen or not used immediately, place it in a clean container and cool as soon as possible.
2. Always thaw frozen food completely in the refrigerator before re-heating.
3. Always reheat food thoroughly and ensure it is piping hot before serving.
4. Only re-heat food **once**.

POINTS TO CONSIDER WHEN PREPARING FOOD FOR SLOW COOKING

1. Make sure that the dishes to be used will fit into the oven ensuring enough room for air to circulate.
2. All dishes cooked on the slow setting will require a minimum of 6 hours, however, if they are cooked for 1-2 hours longer then deterioration in their appearance may be noticed.
3. Never cook joints of meat over 2.7kg (6 lb) or poultry over 2.0kg (4lb 8oz). We do not recommend that joints of meat or poultry are stuffed before cooking on the slow setting.
4. To seal in the meat juices, always cook meat or poultry at 170°C for 30 minutes before wrapping in foil and placing on a rack over a tin (to allow good air circulation) before turning the control to the slow setting and cooking immediately.
5. Always ensure that joints of pork and poultry are thoroughly cooked by checking with a meat thermometer before serving.
6. Always thaw frozen foods completely before cooking. We do not recommend placing frozen food in the oven to cook.
7. Always bring soups, liquids and casseroles to the boil before placing in the oven.
8. Ensure that casserole dishes have a good seal (not airtight) and cover to the top with foil to prevent loss of moisture.
9. Ensure that fruit and vegetables are cut into even sized small pieces to cook properly.
10. Always adjust seasoning before serving.
11. If using dried red kidney beans it is important that the beans are soaked and then boiled for a minimum of 10 minutes before using in any dish to destroy any toxins.
12. When cooking fish or egg dishes it may be necessary to check during cooking to avoid overcooking.



Main Oven Grilling (DE77 & DQ77)

DO NOT allow young children near the appliance when the grill is in use as the surfaces can get extremely hot.

GRILLING SHOULD NEVER BE UNDERTAKEN WITH THE DOOR CLOSED.

- Do Not line the grill pan with aluminium foil.
- Ensure that the grill pan is cleaned after every use. Excess fat build-up in the bottom of the pan could cause a fire hazard.
- Preheat the grill on the required setting for 5 minutes

Grilling Procedure:

1. Open the oven door and position the rod shelf as recommended in the grilling chart (see below) for the food being cooked.
2. Turn the multifunction selector switch to  or  and then turn the Main Oven temperature control to the required setting to pre-heat for approximately 5 minutes.
3. Position the grill pan centrally under the grill element and push back as far as the location stops on the rod shelf.
4. Leave the oven thermostat at setting MAX for toast and for fast cooking of foods. For thicker foods requiring longer cooking turn the thermostat to a lower setting, after initial sealing on both sides at MAX. The thicker the food, the lower the thermostat should be set.
If excessive smoke is emitted, reduce the setting.
5. After use always return both controls to their OFF (O) position.

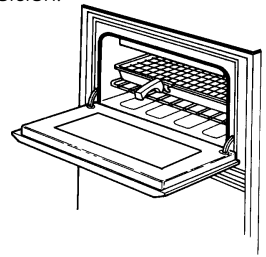

Door position for grilling:

Food	Shelf Position from base of oven	Setting Required Temp °C	Cooking Time
Toasting of bread products	6	MAX	2-5 mins
Small cuts of meat, sausages, bacon etc.	5 or 6	MAX for 4- 6 mins then reduce to setting 170	10-20 mins
Chips, gammon steaks etc.	5	MAX for 6- 8 mins then reduce to setting 170	20-30 mins
Fish: Whole / Fillets Fingers	5 6	170 MAX	15-20 mins 10-15 mins
Pizza's	5	170	10-15 mins
Browning of food	5	MAX	5-10 mins

Care and Cleaning

Warning: Before cleaning, please ensure that the electricity supply to the appliance is switched off and the appliance is fully cold.

1. "STAYCLEAN" OVEN LINERS (Top Oven Sides, Main Oven Sides and Rear Panel)

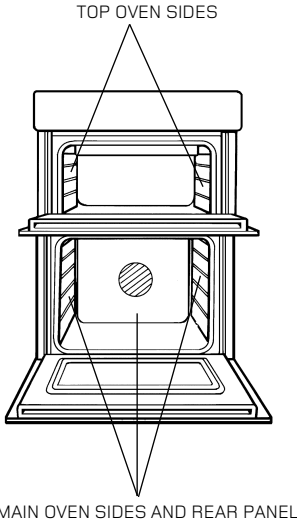

(a) How "Stayclean" works.

The surfaces of the "Stayclean" oven liners (Main Oven rear panel) are treated with a special vitreous enamel which absorbs cooking soils. At temperatures of 220°C (425°F) or above, the special surface enables these soils to be slowly destroyed.

The higher the temperature the more effective it is.

(b) Cleaning.

In most cases normal cooking operations at 220°C (425°F) will permit this cleaning operation to proceed during cooking. However if higher cooking temperatures are not used regularly, it may be necessary, in order to prevent heavy soiling, to run the ovens without shelves or meat pan, at a maximum setting for a couple of hours (Fan Oven mode only).

It should not normally be necessary to clean the "Stayclean" panels with water. If the user feels it is desirable to do so, wipe them over with a clean, soapy cloth, followed by a wipe with a clean damp cloth.

DO NOT use biological washing powder, harsh abrasives or chemical oven cleaners of any kind as this could damage the "Stayclean" oven liners.

2. CLEANING GRILL, TOP OVEN AND MAIN OVEN

(a) Base & Rear of Top Oven and Base of Main Oven.

Wipe out the oven with a damp soapy cloth. For more stubborn stains on the base of the oven use a well soaped fine steel wool soap pad.

(b) Grill Pan, Meat Pan & Oven Shelves.

To prevent stains from being burnt on to the grill pan, food support and rod shelf, always wash immediately after use in warm soapy water.

Use a well soaped fine steel wool soap pad to remove stubborn stains from the rod shelves, grill pan, meat pan and the base of the oven.

DO NOT use aerosol cleaners on this oven as they could adversely affect the fan motor unit, and cannot be wiped off the fan blade.

(c) Solarplus Grill.

To clean the Solarplus Grill, use a clean, damp, soapy cloth and wipe over. If stubborn stains remain, gently clean with a well soaped nylon scouring pad and wipe over with a damp cloth.

DO NOT use metal cleaning utensils, wire wool or proprietary oven cleaners on the grill element mesh.

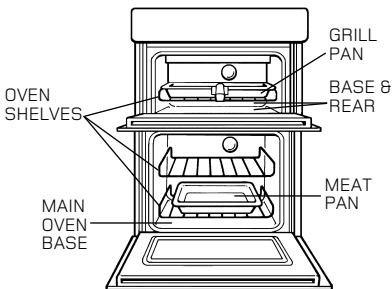

Care and Cleaning

3. OVEN DOORS

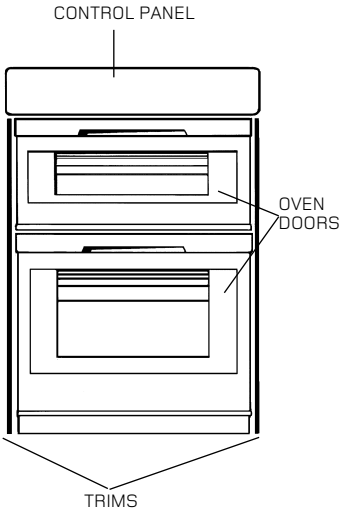

(a) Control Panel

Regularly wipe with a clean, damp cloth and polish with a clean, dry cloth.

(b) Trims

It is advisable to clean the trims regularly to prevent any build up of soiling which may detract from the appearance of the cooker. The recommended method of cleaning is to wipe over the trims with a clean, soft cloth wrung out in warm water, or mild non abrasive cleaner. (If in doubt try the cleaner on a small area of trim which is not noticeable in normal use), then after wiping with a cloth wrung out in clear water, dry with a clean, soft cloth.

(c) Inner Door Panels & Glass

Open the door fully. The glass panel may now be washed. Stubborn stains can be removed by using a well soaped, fine steel wool soap pad.

(d) Stainless trims (DE77 & DE47 only)

Regularly wipe with a clean, damp cloth and polish with a clean dry cloth.

DO NOT use scouring pads, or abrasive powder, which will scratch the glass.

4. REPLACEMENT OF THE OVEN LAMP

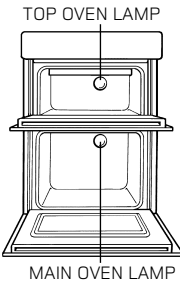

Warning: To avoid electric shocks – please ensure that the electricity supply to the appliance is switched off and the appliance is fully cold, before removing the lamp lens.

Open the oven door and remove the oven shelves. Using a thick cloth, grip the lamp lens, unscrew anti-clockwise and remove the lens. Carefully unscrew the bulb anti-clockwise. Fit replacement bulb (15W 300°C SES) and refit lens.

5. HOW TO CLEAN THE LAMP LENS

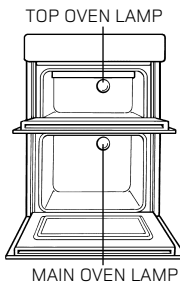

Warning: To avoid electric shocks – please ensure that the electricity supply to the appliance is switched off and the appliance is fully cold, before cleaning lamp lens.

Open the oven door and remove the oven shelves. Using a thick cloth, grip the lamp lens, unscrew anti-clockwise and remove. Clean with a non-abrasive cleansing cream and refit lamp lens.

DO NOT use scouring pads, or abrasive powder, which will scratch the glass lens

Care and Cleaning

Take particular care not to damage the inner surface of the door inner glass that is coated with a heat reflective layer. Do not use scouring pads, or abrasive powder, which will scratch the glass. Ensure that the glass panel is not subjected to any sharp mechanical blows.

Stubborn stains can be removed by using a fine steel wool pad. For slight soiling the inner glass panel may be cleaned, while still warm, without removing it from the door. After cleaning, rinse and dry with a soft cloth.

CLEANING THE DOORS

SIDE OPENING DOORS

Cleaning the door glass is the same as the drop down doors, except take care to support the weight of the inner glass when removing and refitting.

DROP DOWN DOORS

Remove the door inner glass as follows.

1. Open the door fully and unscrew the two screws securing the glass panel so that the securing brackets can be turned. There is no need to remove the screws completely.
2. Turn the brackets so that the glass can be removed and cleaned at the sink (Fig. 1.)

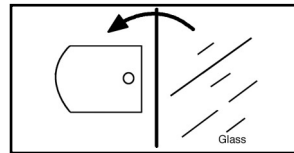

Fig. 1.

3. The inside of the outer door glass can now be cleaned while still fitted to the cooker.

NEVER OPERATE THE COOKER WITHOUT THE INNER DOOR GLASS IN POSITION.

Refit the door inner glass as follows.

1. **NOTE:** The inner door glass has a special reflective coating on one side. Replace the door inner glass so that the statement: **"IMPORTANT THIS FACE TOWARDS THE OVEN"** can be read from the inner side of the door.
2. Turn the two securing brackets back to their original position to retain the glass and tighten the screws. (Fig. 2.)

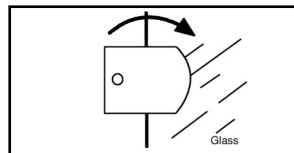

Fig. 2.

Installation

Electrical Requirements

For your own safety, we recommend that your cooker is installed by a competent person such as one who is registered with NICEIC (National Inspection Council for Electrical Installation Contracting). The cooker should be installed in accordance with the latest edition of the IEE Regulations.

Warning: This appliance must be earthed.

Electrical Connections

The installer must check that the voltage shown at the rating plate corresponds with the house electricity supply.

The cooker must be supplied via a suitable double pole isolating switch, having a contact separation of at least 3mm in all poles placed in a readily accessible position adjacent to the cooker.

If the cooker is to be wired into a connector unit, this may be positioned behind the cooker providing the following requirements are met:

- i) The connector unit must not project from the wall more than 25mm.
- ii) The top of the connector must not be more than 130mm above floor level.

Remove the terminal cover at the rear base of the cooker. Pass the cable through the cable clamp and connect to the appropriate terminals provided. Allow sufficient cable for any future servicing.

Tighten the screws on the cable clamp and replace the cover.

Make main connections in the connector unit or cooker control unit.

This appliance conforms to B.S. EN 55014 regarding suppression of Radio and Television reception interference.

A double Pole control switch having a minimum rating of 32 amps should be used to feed the cooker using a suitably rated cable.

Where a hob is fitted adjacent to or over the cooker, a 45 amp Double Pole control switch should be used to feed both units via separate suitably rated cables.

We recommend a minimum of 4mm² PVC insulated twin and earth cable conforming to B.S. 6004 for connection of each appliance.

In all cases adhere to routing details (see fig. 4).

This appliance must not be installed over any other appliance that generates heat such as a plinth heater

Note: Due to many different types of installation, a mains cable is not supplied with this product. The installer will fit the correct type and length of cable.

Installation

Important

It is essential that the lower cupboard is constructed in the manner illustrated i.e. having side, back, and roof panels so joined as to provide no apertures which could permit access to the oven unit when installed.

1. General

The appliance is designed for mounting at a safe level into an oven housing which must be secured to the backing wall.

2. Ventilation

- a. The oven housing unit cabinet dimensions must comply with fig. 4.
- b. An air gap of 50mm minimum must be provided at the rear of any top or bottom cupboards or shelves (see fig. 1).
- c. It is necessary that the cabinets are provided with unobstructed ventilation, i.e. from adjacent cabinetry. This can be done by either raising the base of the cabinets using the adjusting feet (or spacers) or alternatively by providing a slot in the cabinet plinth to the dimensions in fig. 1.
- d. The air gap at rear allows the warmed air to pass out of the inner cabinet space. Where it is intended to fit cupboards above the oven unit to ceiling height, it is essential that the warmed air is exhausted through the front of the cabinet (see fig. 1).
- e. If an oven unit is installed adjacent to a tall cabinet, steam escaping from the oven when the door is opened could condense on and maybe stain the adjacent surface. To prevent permanent staining, the adjacent surface should be made of a material that is heat resisting and easy to clean. Adjacent tall cabinets should not be deeper than the oven housing cabinet.

3. Final Installation

- a. Using a spirit level, check that the housing cabinet is level from side to side and from front to back in its installed position.
- b. Correct any unevenness by placing spacers under the bottom of the cabinet. Make sure that the cabinet rests firmly on the floor without rocking.
- c. Before the oven is fitted, the cabinet must be firmly secured to the backing wall for stability.
- d. The oven unit should now be lifted (this is a two person lift) into the cabinet and pushed fully home.
- e. Finally, the oven is secured to the cabinet by means of the four Pozi Wash Head screws - two through each side trim.
- f. Remove all packaging material from the grill and oven interior.

List of loose items:

4 x Pozi Wash Head No. 6 x 15mm screws.

Tall Cabinet Ventilation

Fig. 1

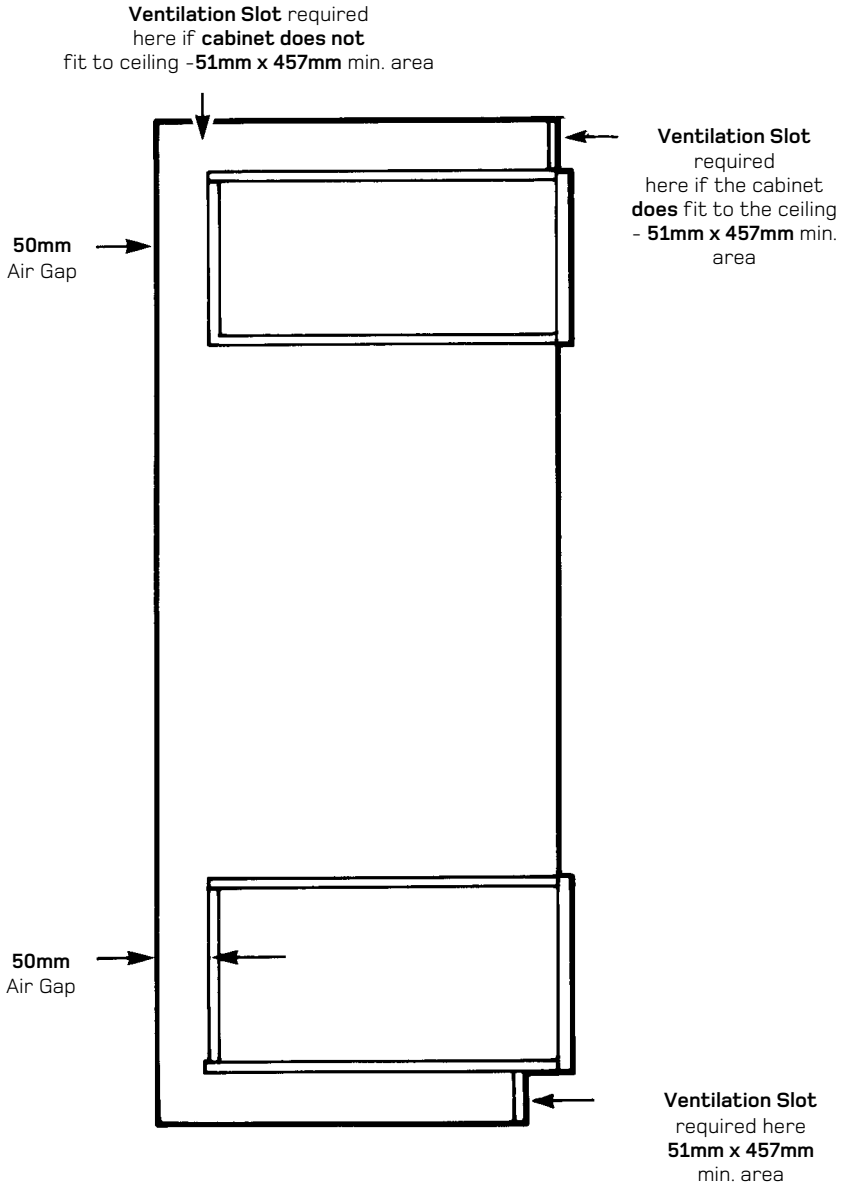

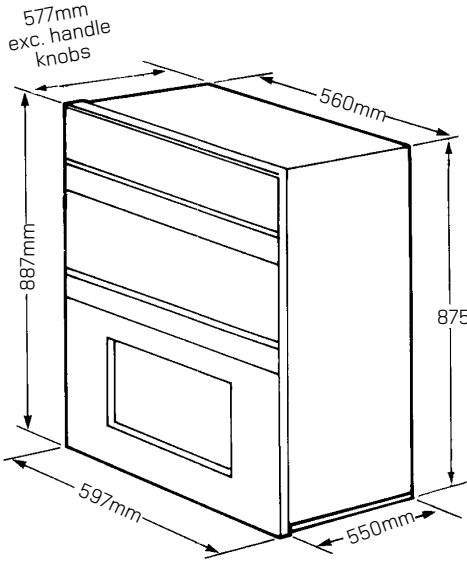
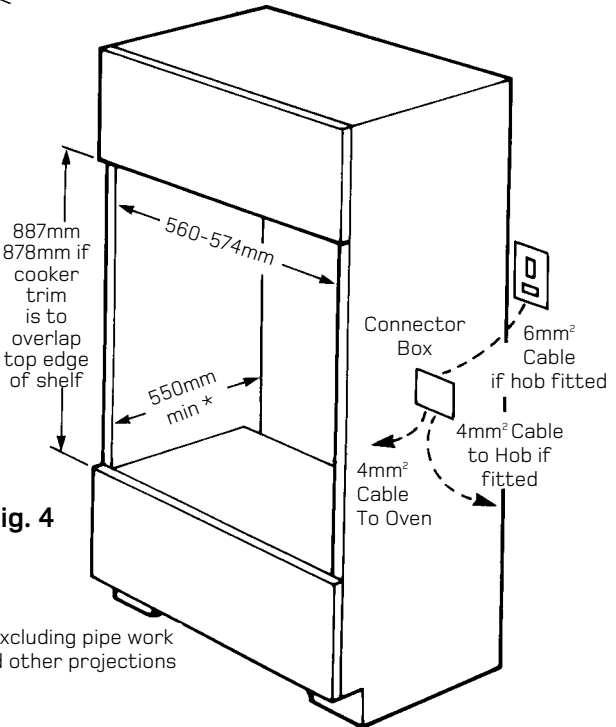
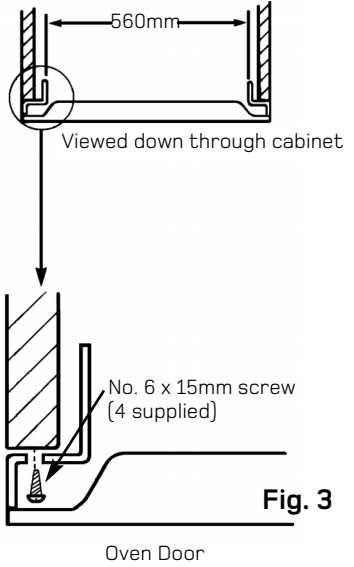

Fig. 2



* excluding pipe work and other projections

If something goes wrong...

Before calling a Service Engineer, please check through the following lists.
THERE MAY BE NOTHING WRONG.

Problem	Check
Slight odour or small amount of smoke when grill / oven used first time	This is normal and should cease after a short period.
Nothing Works	If you find that the timer display is blank, then it is likely that there is no electricity supply to your oven. Check: <ul style="list-style-type: none"> (i) That the main cooker wall is switched on. (ii) Other appliances, to see if you have had a power cut. (iii) The main circuit breaker for the property.
Timer Display shows "0:00" with "Auto" Flashing	The power supply to your oven has possibly been interrupted, but has now come back on again. Reset the timer to the correct day and "Manual" operation using the instructions given in the timer section of the book.
Main oven and Top ovens do not work, but the grill works	Your timer may be set for an Auto Cooking programme: Check the timer to see whether 'Auto' is lit or flashing. If it is then please follow the instructions given in the Timer section of this book to return the timer to Manual operation.
Top oven and grill do not work, but Main oven works.	Operating the cooker under the following conditions may cause a safety device to operate: <ul style="list-style-type: none"> (a) Grilling with the door closed - Always grill with the door fully open. (b) Grilling for an excessively long period at maximum setting - see Grilling guide. Switch off appliance and allow to cool for approx 30 mins. Switch the cooker back on and check that the Grill/Top oven is now operating.
Grill does not work	Ensure that the top oven control is in the off position.
Grill keeps turning on and off	When the Grill control is operating at less than its maximum setting, the Grill will cycle on and off, this is normal and <u>not</u> a fault.
Timer buzzer / audible tone operates continually	To cancel the audible tone, press the minute minder button.
Oven temperatures too high or low	Check temperature and shelf positions are as recommended in the Oven Temperature Charts. It may be necessary to increase or decrease the recommended temperature slightly to suit your taste.
Oven does not cook evenly	Check: <ul style="list-style-type: none"> (a) Temperature and shelf positions are as recommended in the Oven Temperature Charts. (b) Oven utensils being used allow sufficient air flow around them.

If something goes wrong...

Problem	Check
Grilling is uneven.	Ensure that Grill pan has been positioned as stated in the Grilling section of this book.
Oven lamp does not work.	The oven lamp is not covered by the guarantee. The part is easily changed (see the section on oven lamp replacement) A new lamp may be obtained from our Genuine Parts & Accessories Hotline (see 'Key Contacts', back page).
Condensation on the wall at the rear of the cooker.	Steam and / or condensation may appear from the vent at the rear of the appliance when using an oven particularly for foods with a high water content e.g. frozen chips, roast chicken etc. This is normal, and any excess should be wiped off.
Steam / Condensation in the oven after use.	Steam is a by - product of cooking any food with a high water content. To help minimise always: a) Try to avoid leaving food in the oven to cool after being cooked. b) Use a covered container, wherever possible.

If you have been through the above list and there is still a problem, contact Service (see KEY CONTACTS, back page).

Disposal of your product

To minimise the risk of injury to children please dispose of your product carefully and safely. Remove all doors and lids. Remove the mains cable (where fitted) by cutting off flush with the appliance and always ensure that no plug is left in a condition where it could be connected to the electricity supply.

To help the environment, Local Authority instructions should be followed for the disposal of your product.

Disposal of old electrical appliances

The European Directive 2002/96/EC on Waste Electrical and Electronic Equipment (WEEE), requires that old household electrical appliances must not be disposed of in the normal unsorted municipal waste stream. Old appliances must be collected separately in order to optimise the recovery and recycling of the materials they contain and reduce the impact on human health and the environment.



The crossed out "wheeled bin" symbol on the product reminds you of your obligation, that when you dispose of the appliance it must be separately collected. Consumers should contact their local authority or retailer for information concerning the correct disposal of their old appliance.

Hotpoint Service Cover

Satisfaction Guaranteed or Your Money Back

Hotpoint gives you a unique 'Satisfaction Guaranteed' promise – valid for ninety days after you have purchased your Hotpoint product. If there is a technical problem with your Hotpoint appliance, just call Hotpoint Service (see back page). If necessary we will arrange for an engineer to call. If the technical problem is not resolved under this Guarantee, Hotpoint will replace your appliance or, if you prefer, give you your money back. Your statutory rights are not affected, and the Guarantee is additional and subject to the terms of Hotpoint's Five Year Parts Guarantee.

Hotpoint's Free Five Year Guarantee

From the moment your appliance is delivered Hotpoint guarantees it for **FIVE YEARS**.

- In the Five Years all replacement parts are **FREE** provided that they are fitted by our own Service Engineer. During the first year our Engineer's time and labour is also free.
- Our guarantee covers loss of food in our refrigeration and freezer products up to £250 during the first year, subject to verification by one of our engineers.
- After the first year we will charge for our Engineer's time and labour. We do, however, operate a range of Service Plans (see opposite) which, for an annual payment, enables you to cover any repair costs which may be necessary.
- All our service repairs are guaranteed for twelve months in respect of our labour and any parts fitted.
- The appliance must be used in the United Kingdom, and must not be tampered with or taken apart by anyone other than our own Service Engineers.
- You may, however, buy parts which can be safely fitted without specialist knowledge or equipment. The correct fitting of such parts, provided they are genuine Hotpoint spares, will not affect your Guarantee. Parts are available from our Hotpoint Spares Centres (see back page).
- Our guarantee does not cover the cost of any repair, or loss of food in refrigeration products, due to power failure, accidents or misuse. Nor does it cover the cost of any visits to advise you on the use of your appliance. Please read thoroughly the instruction book supplied with this appliance.
- If at any time during the Guarantee period we are unable to repair your appliance, we will refund any repair costs paid to us in the previous twelve months. We will also offer you a new appliance at a reduced charge instead of a repair.
- Our Guarantee is in addition to and does not affect your legal rights.
- Should you need independent advice on your consumer rights, help is available from your Consumer Advice Centre, Law Centre, Trading Standards Department and Citizens Advice Bureau.
- All Hotpoint servicing is carried out by our own Service Organisation located throughout the United Kingdom and Eire. We will be happy to deal with any problems which you may have.

Hotpoint's Extended Warranties

Whether you have just one or a number of Hotpoint appliances in your kitchen, Hotpoint has a range of Service Plans to give you complete peace of mind. They enable you to extend your one year labour guarantee so that you can have repairs completed **FREE** during the membership period.

Service Cover

We offer a number of payment methods; cheque, credit card or you can spread the cost and pay by direct debit (full details can be obtained on Free phone 0800 716356). This covers you for all repairs during the period of cover, which can be from 1 to 4 years. Service Cover also includes loss of food, up to the value of £250, in refrigeration appliances. There is also an option of Service Cover with Maintenance at an additional cost. This includes an annual Electrical and Safety check and replacement of any parts as necessary.

Kitchen Cover

An annual payment covers you for all repairs for all your Hotpoint appliances which are less than ten years old. It also covers the cost of loss of food up to £250 in our refrigeration and freezer products. There is also the option of Kitchen Cover with Maintenance at an additional cost. Any additional Hotpoint appliances purchased after you have joined Hotpoint Kitchen Cover will automatically be included during the annual period of cover without further charge.

Appliance Registration

To ensure that you have the opportunity to benefit from any of the above Service Schemes and other offers you should complete and return immediately the Appliance Registration Form/Questionnaire supplied with this appliance. Full details and costs of our Service Schemes, together with an application form, will be sent to you at the end of the first year of the guarantee.

Annual Safety/Maintenance Checks

Hotpoint strongly recommends that all its appliances are regularly checked for electrical and mechanical safety, whether or not they are covered by a Service Plan. Worn door gaskets or hoses may cause a leak on an appliance, which could become dangerous if neglected.

Proof of Purchase

For future reference please attach your purchase receipt to this booklet and keep it in a safe place.

Spares and Accessories

Spares and accessories can be ordered from your local Hotpoint Spares Centre (see back page), using the order form enclosed.

NOTE: Our Engineers will use every effort to avoid damage to floor coverings and adjacent units when carrying out repairs/service work, but in locations where the Engineer advises you that it will be impossible to move appliances without risk of damage, he will only proceed with your approval that no liability is accepted.



Key Contacts

Service

Hotpoint has the largest appliance manufacturer's service team in Europe, trained specialists directly employed by us to ensure your complete confidence.

Repair Service

UK: 08709 066 066

Republic of Ireland: 1850 302 200

You will be asked for the following information:-

Name, address and postcode.

Telephone number

Model / Serial number of the appliance

Clear and concise details of the query or fault

Place and Date of purchase

(Please keep the receipt as evidence will be required when the engineer calls).

Extended Warranty

To join: UK 08709 088 088

Republic of Ireland: 1850 502 200

Genuine Parts & Accessories

Mail Order Hotline

UK: 08709 077 077

Republic of Ireland: (01) 842 6836

For further product information 08701 506070

All Hotpoint Services are offered as an extra benefit and do not affect your statutory rights.

Indesit Company UK Limited, Morley Way, Peterborough, PE2 9JB

Free Manuals Download Website

<http://myh66.com>

<http://usermanuals.us>

<http://www.somanuals.com>

<http://www.4manuals.cc>

<http://www.manual-lib.com>

<http://www.404manual.com>

<http://www.luxmanual.com>

<http://aubethermostatmanual.com>

Golf course search by state

<http://golfingnear.com>

Email search by domain

<http://emailbydomain.com>

Auto manuals search

<http://auto.somanuals.com>

TV manuals search

<http://tv.somanuals.com>