

Hotpoint Service Offices

SERVICE CALL: If you have a problem with your appliance ring your local Service Office. SPARES and ACCESSORIES: To purchase spares and accessories send your Accessories Order Form to your Spares Centre. If the accessory or spare part you want is not on the form then contact your Spares Centre for prices and availability. Please address all correspondence to Hotpoint Spares Centre or Hotpoint Service Office as applicable.

Service Offices and Spares Centres are open between 8.30am-5.00pm Monday to Friday, except on Public Holidays. 8.30am-12.30pm Saturdays

EASTERN

- **NORWICH:**
92 Upper St, Giles Street, NR2 1LT.
Tel: Norwich (01603) 626881.
- **PETERBOROUGH:**
Celta Road, PE2 3UB.
- **LONDON:**
Tel: Peterborough (0733) 64741.
- **LONDON:**
5 Crowley Road, LU1 1HX
Tel: Luton (0582) 482211.
- **CHELMSFORD:**
Industrial Buildings
Peeney Lane, CM2 9TE
Tel: Luton (0582) 482211.
Remainder of Essex
Chelmsford (0245) 492433
Chelmsford (0245) 269331.

EAST MIDLANDS

- **LEICESTER:** 65 Bellgrave Gate, LE1 3HR.
- **LINCOLN:** 142 St. Marys, LN6 3EP.
- **WELLS:** 100 High Street, BA5 1JW.
- **395 C. Longbridge Street, N18 1DW**
- **WELLINGBURY:** 40 Newby Way, MK33 23669
- **NOTTINGHAM:** 40 Newby Hill Lane, NG2 3UB.
Tel: Service Office Nottingham (0602) 86243
Spares Centre Nottingham (0602) 860387.

LONDON and SOUTH EAST

- **SUTTON:** 2 St. Nicholas Road, SM1 1EH.
Tel: 081 643 0921
- **HALLS HALL:** 146 Highwood, North Street, B197 1DD. Tel: Hatfield (02323) 842733.
- **WIMBORNE:** 68 East Lane, LA9 7JQ.
Tel: Office W. W. Harris and Midlands (081) 904 1309
Office W. W. Harris (081) 904 1250
N. E. EC 081 908 4722
SE and SW 081 908 2511
Spares Ca and SW 081 908 0201
- **LARKFIELD:** Larkfield Trading Estate, Newby Lane, ME20 6SU
Tel: Service Office Maidstone (0622) 716571
Spares Centre Maidstone (0622) 716531.

CHANNEL ISLANDS

- Service provided by agents
The normal United Kingdom guarantees apply and all services schemes are available.
- **JERSEY:** 19 Don Street, St. Helier. Tel: (0534) 21625
Clos D'Ormes, Pontac, St. Clements. Tel: (0534) 54808.
 - **GUERNSEY & SARK:** Valpys Stores, Grande Rue, St. Martin, Guernsey. Tel: (0481) 38422.
15 Le Poller, St. Peter Port, Guernsey. Tel: (0481) 23311.
Lowlands, Brave Road, Vale, Guernsey. Tel: (0481) 48264.
 - **ALDERNEY:** 32 High Street, Alderney. Tel: (0481) 822886.

Spares and accessories may be ordered from Hotpoint Spares Administration Dept., Celta Road, Peterborough, PE2 9JB.

In accordance with its policy of progressive product design, the Company reserves the right to alter specifications. Hotpoint Ltd, Peterborough, PE2 9JB, England

NORTH EAST

- **NEWCASTLE:**
21 Masey Street, NE1 1VE.
Tel: Newcastle (0191) 2321008
- **WIDNES:** 100 High Street, W59 6UR
- **PETERBOROUGH:** 59 North Road, TS1 1NG
Tel: Peterborough (0542) 248436
- **HULL:** 120-124 Victoria Street, Hull, HU1 4AE. Tel: Hull (0482) 294771.
- **WILKINSON:** 100 High Street, Swinton Works, SO4 1EA
- **HEARNING:** 100 High Street, Swinton Works, SO4 1EA
Tel: Huddersfield (0484) 582831
- **WETHERBY:** 100 High Street, Wetherby Lane, LS22 4TW.
Tel: Service Office Wetherby (0937) 61261/61444
Spares Centre Wetherby (0937) 61221.

NORTH WEST

- **RENDAL:** 2B Highgate, LA9 4SX.
- **LETHBRIDGE:** 174463.
- **PRESTON:** 24/25 Cannon Street, PR1 3NR. Tel: Preston (0772) 24311.
- **ST. HELENS:** 40 Newby Hill Lane, CH6 5ST. Tel: St. Helens (0744) 35152.
- **ELLESMERE PORT:** 165 2ER.
Tel: Ellesmere Port (0527) 33774
- **STOCKPORT:** 44/45 Station Road, Heaton Mersey, SK9 3QJ.
Tel: Service Office (081) 442 8677 (South) 081 482 0513 (North)
Spares Centre 081 432 0255.

SCOTLAND

- **ABERDEEN:** 68 Carden Place, AB1 1UL.
- **DUNDEE:** 140 High Street, Dundee. Tel: Dundee (0224) 642283.
- **EDINBURGH:**
South Te. Street, DD1 1NF.
Tel: Dundee (0382) 28383.
- **GLASGOW:**
55 West Bowling Green Street, Leith, EH6 5NY.
Tel: 031 554 1431
- **BIRMINGHAM:** West Lodge Road, Blythwood Estate, PK4 9EN
Tel: Service Office 041 886 6241
Spares Centre 041 886 6511.

FULL INSTRUCTIONS FOR INSTALLING AND OPERATING YOUR HOTPOINT BUILT-IN/ BUILT-UNDER OVEN MODEL 6142

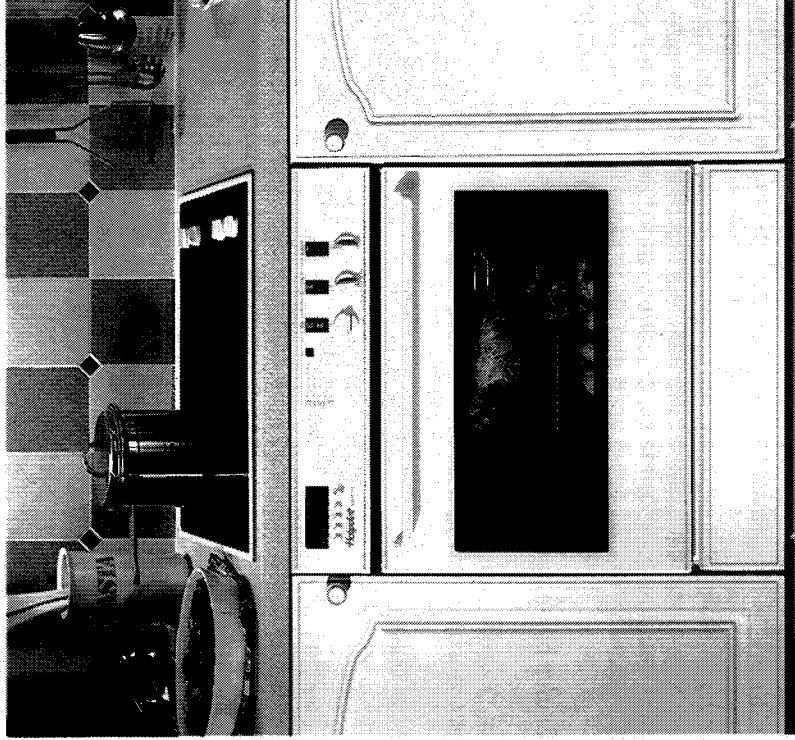

Hotpoint®

Before you operate your new Hotpoint Built-In/Built-Under Oven

Please read these instructions fully.

1. Ensure that the cooker is installed by a qualified electrician following the instructions below.
2. For your own safety and to get the best results from your oven it is important to read through this Handbook **before** using your cooker for the first time.

Electrical Requirements

- Any electrical wiring must be carried out in compliance with the appropriate IEE and electricity board regulations by a qualified electrician, eg. your local electricity board or a contractor who is on the roll of the National Inspection Council for Electrical Installation Contracting (NICEIC).

- **WARNINGS – INCORRECT INSTALLATION COULD AFFECT THE SAFETY OF THE OVEN.**

- **ALL APPLIANCES MUST BE EARTHED.**
- **BEFORE CONNECTING OR INSTALLING THE OVEN THE ELECTRICITY SUPPLY MUST BE SWITCHED OFF.**

- **THE INSTALLER MUST** check that the voltage shown on the rating plate corresponds with the house electricity supply.
- The oven can be connected to a standard 13A supply with a switch in a readily accessible position adjacent to the unit, or the oven must be supplied via a suitable double pole isolating switch.
- The loading for this appliance is 2.8kW.
- If the oven is to be wired into a connector unit this may be positioned behind the oven provided the following requirements are met:
 - i) The connector unit must not project more than 25mm from the wall.
 - ii) The top of the connector must not be more than 100mm above the base of the oven recess.
- After unpacking the oven, stand it on the packing base to avoid damage.

Electrical Connections

- Remove the terminal cover at the rear base of the cooker. Pass the cable through the cable clamp and connect to the appropriate terminals provided. Allow sufficient cable so that the oven can be set down on the floor whilst still connected up. Tighten the screws on the cable clamp and replace the terminal cover. Make mains connections.

**WARNING: CHILDREN SHOULD NOT BE ALLOWED TO PLAY WITH THE CONTROLS OR TAMPER WITH THE APPLIANCE.
YOUR OVEN SHOULD NOT BE LOCATED ADJACENT TO A GAS HOB, HEATER OR EYE LEVEL GRILL, AS FLAMES FROM THE BURNERS COULD CAUSE DAMAGE TO YOUR OVEN.**

Hotpoint Service Cover

Satisfaction Guaranteed or Your Money Back

Hotpoint gives you a unique 'Satisfaction Guaranteed' promise – valid for ninety days after you have purchased your Hotpoint product. If there is a problem with your Hotpoint appliance just call your Hotpoint Service Office. If necessary we will arrange for an engineer to call. If the problem is not resolved by us under this Guarantee, Hotpoint will replace your appliance or, if you prefer, give you your money back. This Guarantee is additional and subject to the terms of Hotpoint's Five Year Parts Guarantee.

Hotpoint's Free Five Year Guarantee

From the moment your appliance is delivered, Hotpoint guarantees it for **FIVE YEARS**.

- In the Five Years all replacement parts are **FREE** provided they are fitted by our own Service Engineer. During the first year our Engineer's time and labour is also free.
- After the first year we will charge for our Engineer's time and labour. We do, however, operate a range of Service Plans (see opposite) which for an annual payment enables you to cover any repair costs which may be necessary.
- All of our service repairs are guaranteed for twelve months in respect of our labour and any parts fitted.
- The appliance must be used in the United Kingdom and must not be tampered with or taken apart by anyone other than our own Service Engineer.
- You may, however, buy parts which can be safely fitted without specialist knowledge or equipment. The correct fitting of such parts, provided they are genuine Hotpoint spares, will not affect your Guarantee. Parts are available from our main Hotpoint Spares Centres (see back page).
- Our Guarantee does not cover the cost of any repair which is needed because of power cuts, accidents or misuse. Nor does it cover the cost of any visit to advise you on the use of the appliance. Please read the instruction book thoroughly.
- If at any time during the Guarantee period we are unable to repair your appliance, we will refund any repair costs paid to us in the previous twelve months. We will also offer you a new appliance at a reduced charge instead of a repair.
- Our Guarantee is in addition to and does not affect your legal rights.
- Should you need independent advice on your consumer rights, help is available from your Consumer Advice Centre, Law Centre, Trading Standards Department and Citizens

22

Contents

	Page
Before you operate your new Hotpoint Built-In/Built-Under Oven	2
Electrical Requirements	2
Installing your Oven	4-5
The main parts of your Oven	6
3 Cooking Systems in your Oven	7
The Controls	8
The Automatic Oven Timer	9-11
Before using your Oven for the first time	12
Position of Shelves	13
Grilling	14
Conventional Cooking	15
Fan Cooking	16
Fan Grilling	17
Care and cleaning of the Oven	18-19
If something goes wrong	20
If it still won't work	21
Hotpoint Service Cover	22
Hotpoint Service Offices and Spares Centres	back page

Retention of this Instruction Book

This Instruction Book must be kept handy for reference as it contains important details on the safe and proper use of the appliance.

If you sell or pass the appliance to someone else, or move house and leave it behind, make sure this Book is also provided so the new owner can become familiar with the appliance and safety warnings.

If the Book is lost or damaged a copy may be obtained from Hotpoint Ltd, Celta Road, Peterborough, PE2 9JB.

Advice Bureau.

- All Hotpoint servicing is done by our own Service Organisation located throughout the United Kingdom and Southern Ireland. It will be happy to deal with any problems.

Hotpoint's Service Care

Whether you have just one or a number of Hotpoint appliances in your kitchen Hotpoint has a range of Service Schemes to give you complete peace of mind.

Service Cover

One annual payment covers you for all repairs to **individual appliances**.

If two or more appliances are covered a 20% reduction is made on each fee. There is also the option of **Service Cover with Maintenance** at an additional cost. Service Schemes are renewable each year by mutual agreement.

Cooker Cover

One annual payment covers you for all repairs for **any number of Hotpoint Ovens, Microwaves, Hobs and Cooker Hoods** purchased. There is also the option of **Cooker Cover with Maintenance** at an additional cost.

Kitchen Cover

One annual payment covers you for all Repairs and a Maintenance Check for **all Hotpoint appliances owned** which are less than ten years old. Kitchen Cover also covers loss of food up to the value of £250 in our refrigeration and freezer products. Any additional Hotpoint appliances purchased after you have joined **Hotpoint Kitchen Cover** will automatically be included during the current annual period of cover without any further charge.

Appliance Registration

To ensure that you have the opportunity to benefit from any of the above Service Schemes you should complete and return immediately the Appliance Registration Form supplied with your appliance. Full details and costs of our Service Schemes together with an application form will be sent to you at the end of the first year of the guarantee.

Annual Safety/Maintenance Checks

Hotpoint strongly recommends that all its appliances are regularly checked for electrical and mechanical safety whether or not they are covered by a Service Plan.

Proof of Purchase

For future reference please attach your purchase receipt to this booklet and keep it in a safe place.

Spares and Accessories

Spares and accessories can be ordered from your local Hotpoint Spares Centre (listed on the back page), using the order form enclosed.

Installing your Oven

Dimensional Requirements

The oven can be built under a work surface or into a tall housing unit.

Dimensions for the housing unit under a work surface are given in Fig. 1. For a tall housing unit the recess should be similar. If the housing unit is not already attached to the wall this MUST be done using the bracket supplied.

Adequate ventilation must be provided — see Fig. 2 for ventilation under a work surface and Fig. 3 for a tall housing unit. For the tall housing unit particular attention must be paid to ensure that the air inlet and outlet areas are kept clear and sufficient space is allowed between the top of the housing unit and the ceiling.

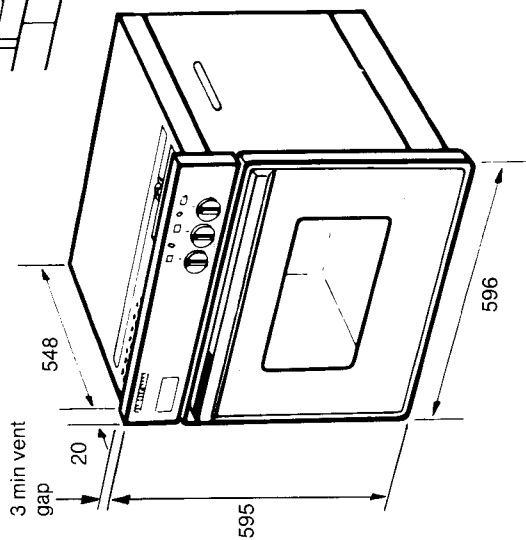

The housing unit into which the oven is to be placed should be solid wood or have a melamine or laminate finish.

4

If it still won't work...

Contact the Service Office

If there is still a problem with your Oven after checking the points above:

1. Switch off the Oven at the cooker control panel.
2. Call your nearest Hotpoint Service Office or local importer (outside the UK). The telephone number is shown on the back of the space below:

.....

When you contact us we will want to know the following:

1. Your name, address and post code.
2. Your telephone number.
3. Clear and concise details of the fault.
4. The model number of your machine (6142) and the colour.
5. The date of purchase. Enter the date here:

.....

Please make sure you have these ready when you call.

Spare Parts

Please remember your new appliance is a complex piece of equipment.

'DIY' repairs or unqualified and untrained service people may put you in danger, could damage the appliance and might mean you lose cover under Hotpoint's Parts Guarantee.

If you do experience a problem with the appliance don't take risks; call in Hotpoint's own Service Engineer. The address and telephone number of your nearest Hotpoint Service Office is in your local telephone directory.

Our spare parts are designed exclusively to fit only Hotpoint appliances. Do not use them for any other purpose as you may create a safety hazard.

If something goes wrong...

First, don't panic! There may be nothing wrong. Check the points below before calling your Hotpoint Service Office.

1. Check that the mains supply is switched on.
2. If the Timer is showing **000** and is flashing then the power supply has been interrupted and the Timer must be reset (see page 9).
3. Check that the Oven Timer has been set to manual operation and not left on automatic (see pages 10 and 11).
4. Have you turned both the Oven Selector **[E]** and the Oven Temp Selector **[D]** to the appropriate positions.
5. If grilling have you turned the Oven Temp Selector to **[E]** or **[F]** and the Dual Grill Control to the required setting.

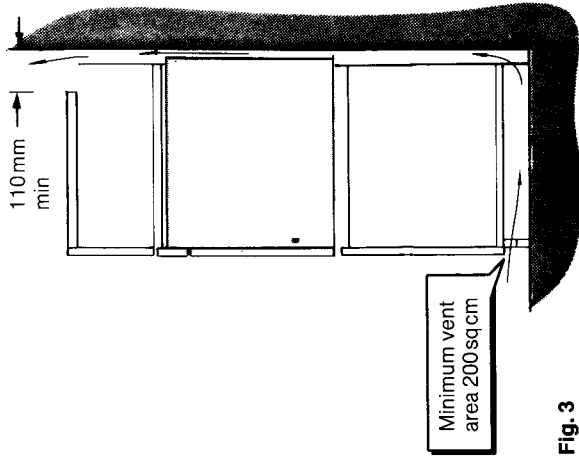

Fig. 3

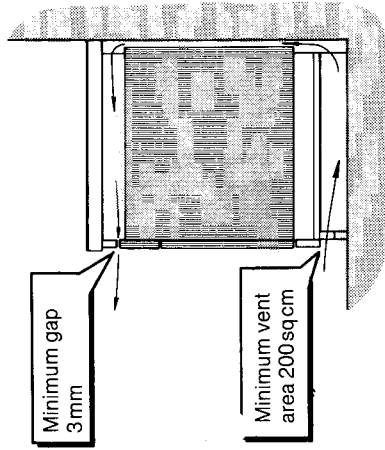

Fig. 2

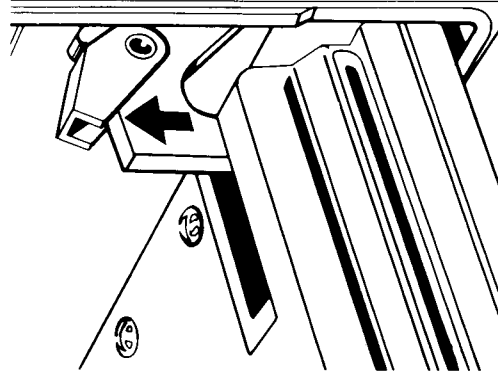

Fig. 4

Do not lift or carry the oven by the door handles. It is advisable to move the oven door before attempting to lift the oven. To do this open the door fully and swing the hinge steps upwards (Fig. 4). Close the door as far as the 'stop' position. Lifting the door slightly pull it, complete with hinges, away from the oven housing (Fig. 5). Then lift up the

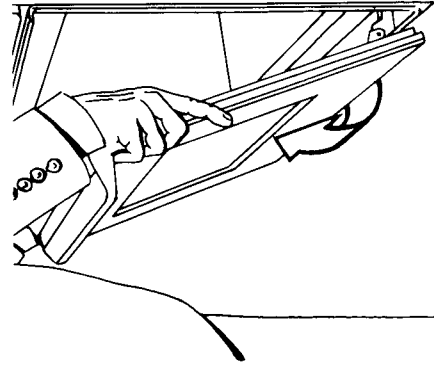
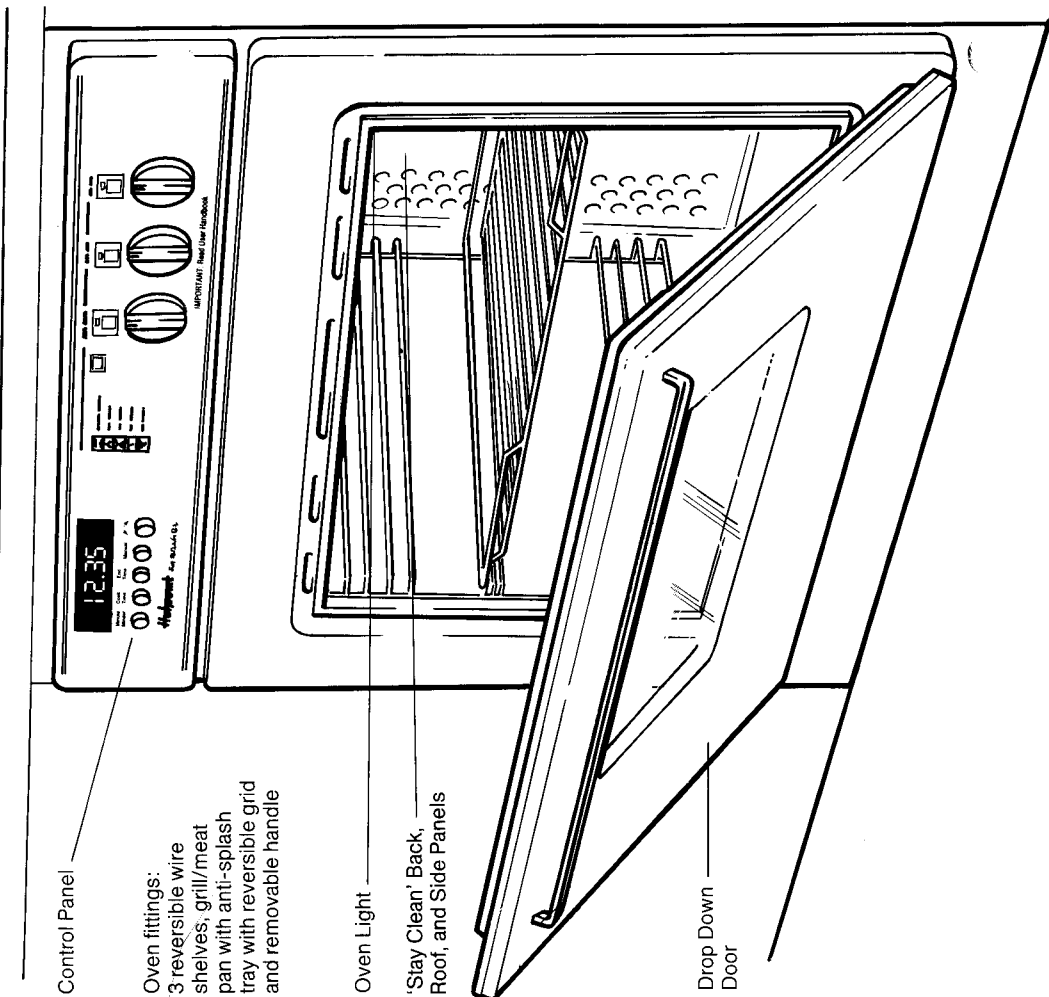

Fig. 5

oven using the handles in the side of the oven casing and push it into the recess, making sure that the connecting cable is not trapped beneath or behind. Centralise the oven within the housing unit and secure through the side trims using two of the black screws supplied. Replace the oven door.

The main parts of your Oven



WARNING: DO NOT TOUCH THE GLASS DOOR WHEN THE OVEN IS IN USE AS THIS AREA CAN BECOME HOT.

'Stay Clean' Liners

The back, roof and sides of the oven are fitted with 'Stay Clean' Liners which absorb cooking soils.

At high temperatures the special surface enables these soils to be slowly destroyed. The higher the temperature the more effective this will be. In most cases this cleaning operation will take place during cooking. However, if higher cooking temperatures are not regularly used then it may be necessary, in order to prevent heavy soiling, to run the oven from time to time at a higher setting of 250°C for a couple of hours.

Should it be necessary the 'Stay Clean' side and roof panels can be removed by simply sliding them out. The 'Stay Clean' liners can then be washed in warm soapy water followed by rinsing in clear water. Dry well with a soft cloth.

Note

DO NOT grill without the roof liners in position.

DO NOT use enzyme washing powders, harsh abrasives or chemical oven cleaners of any kind.

DO NOT wash the 'Stay Clean' liners in a dishwasher.

To remove the metal shelf fittings from the side liners simply push the metal fittings upwards until the base section is disengaged from the retaining holes. To replace the fittings place the longer locating ends into the retaining holes at the top of the side liner and allow the fitting to slide down to engage the base section in the retaining holes.

Oven Fittings

The shelf fittings can be removed as described above. They and the wire shelves can be cleaned either in a dishwasher or by using a fine steel soap pad to remove stubborn stains.

Oven Interior

To clean the oven interior remove all the oven fittings and if necessary the 'Stay Clean' liners.

All types of oven cleaners can be used, but **DO NOT** allow abrasive cleaners or oven spray to come into contact with the 'Stay Clean' liners, oven surround or trims. Use a fine steel wool soap pad to remove stubborn stains.

How to replace the oven light

Should the oven light fail to work, **switch off** the mains supply to the oven. Access to the bulb can be gained after first removing the lamp cover by turning anti-clockwise. The bulb can then be unscrewed and replaced by one of a similar type (Part No. 613002) which can be obtained from your nearest Hotpoint Service Centre (see back cover).

Note: Additional shelves can be obtained from your local Hotpoint Spares Centre, listed on the back page.

Care and Cleaning of the Oven

WARNING: BEFORE CLEANING SWITCH THE OVEN OFF AT THE COOKER CONTROL PANEL AND ALLOW IT TO COOL.

Cleaning the Outside

Clean the outside by wiping down with a damp cloth using a small amount of detergent, followed by wiping down with a dry clean cloth.

Note: DO NOT use scouring pads or abrasive powder which will scratch the glass.

Cleaning the Oven Door



The door can be removed for cleaning. To do this, open the door and swing the hinge stops upwards (Fig. 6). Close the door as far as the 'stop' position. Lifting the door slightly, pull it, complete with hinges, away from the oven housing (Fig. 7).

Stubborn stains on the inside of the door can be removed by using a liquid cleaner eg. *Jiff*. During cleaning the doors must not be immersed in water. Do not use cleaners which contain bleach as they may dull the surface. After cleaning, wipe over with a damp cloth and dry with a soft cloth.

WARNING: DO NOT RUN THE OVEN WITHOUT THE DOOR FITTED.

The Cooking Systems in your Oven

Your new oven is equipped with four different cooking systems:

1. **Conventional Cooking**  – with upper and lower heat. This system is particularly suitable for roasting and baking on one shelf only.
2. **Fan Cooking**  – the fan oven operates by constantly moving heated air around the oven. This gives improved efficiency and, in general, enables the use of lower temperatures for cooking. It also means that there is less need to be particular about shelf positions and that you can bake at more than one level simultaneously.

3. **Fan Grilling**  – this is a combination of heat from the grill element and hot air circulated by the fan. Joints of meat and poultry will be browned as if they were cooked on a rotisserie or spit but more economically as the door is left closed.

4. **Grilling**  – the oven can also be used for conventional grilling with a full width, fully controllable grill.

The grill also has an economy setting which enables you to use just the middle section.

Note: The Oven Door should be closed when grilling.

These four systems of cooking are described more fully in the separate Recipe Book and we would suggest you read right through the introductory Section of that book before using the oven.

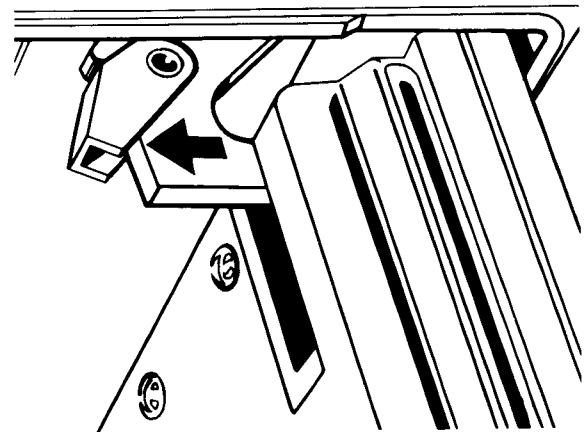
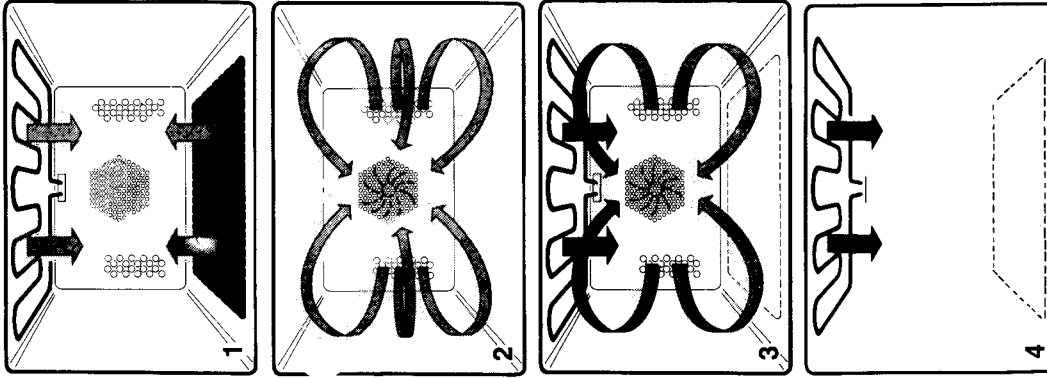

Fig. 6

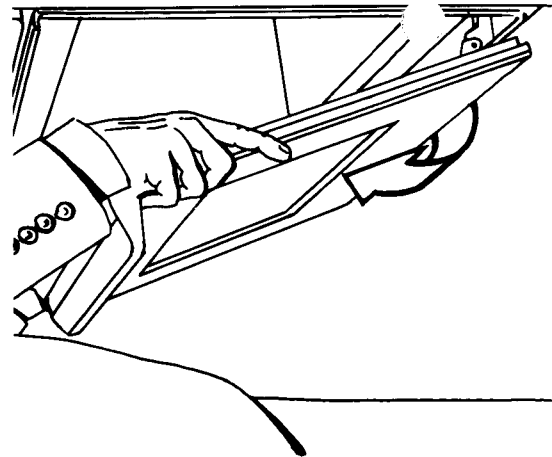
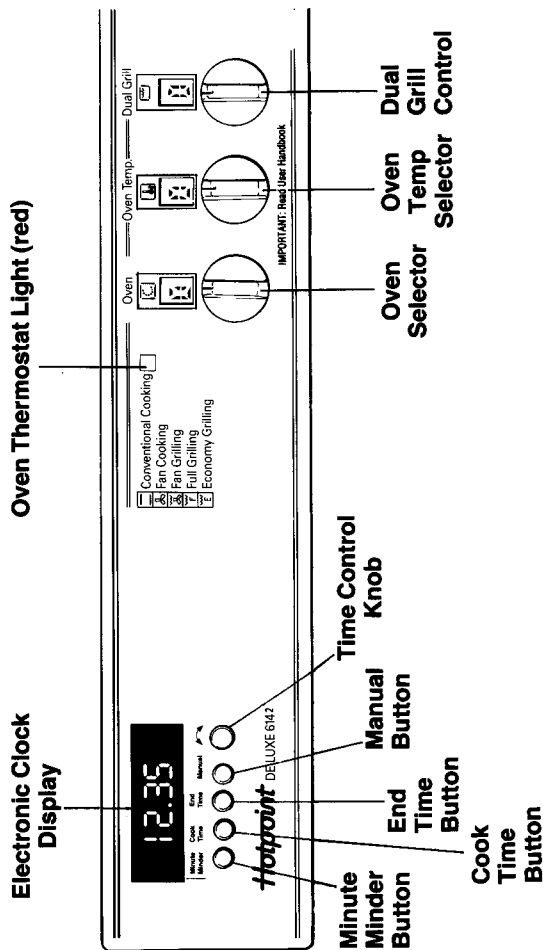

Fig. 7

The Controls



Before using the Oven, the Oven Selector [C] must be turned to the appropriate position. The control has three settings.

- Fan Cooking
- Fan Grilling
- Conventional Cooking

When the Oven Selector is turned to one of these settings the Control Panel will light up and the light inside the oven will come on.

Now turn the Oven Temp [D] clockwise to the required temperature. The thermostat light will immediately come on when either Conventional [E] or Fan [F] Cooking is selected and will remain on until the oven reaches the

required temperature. The light will then automatically go on and off during cooking as the oven thermostat maintains the temperature. If the thermostat light does not come on when the Oven Temp is turned on, make sure that an arrow is not flashing above the Manual Button on the Automatic Oven Timer. This means that the Oven is in the Automatic mode and to change it to Manual operation, the Manual Button must be pressed so that the arrow disappears. When Fan Grilling [G] is selected the thermostat light will not operate.

To use the grill set the Oven Temp Selector to [E] Economy or [F] Full width setting and the Dual Grill Selector within the range of 1-9 and remember to keep the oven door closed. After use, always set the controls back to 'O' Off.

Fan Grilling

Turn the Oven Selector [C] to [G] and the Oven Temp Selector [D] to the required temperature. The heat for Fan Grilling is provided by the grill element at the top of the oven and this heat is circulated around the food by the fan. The element and the fan are switched off and on alternately. It is ideal for roasting a joint or a chicken and has the same result as if you were cooking on a rotisserie but is economically as the door is left closed. There is no need to pre-heat the oven. Insert the grill pan and anti-splash tray on the floor of the oven or at shelf position 1. Place the food on one of the oven shelves and insert at shelf position 1, 2 or 3, depending on the height of the food. For large pieces of meat or several pieces a lower temperature and a longer grilling time will be necessary.







Warming Dishes

The Oven can be used just to warm dishes or for keeping food hot. Dishes should not be placed directly on the floor of the oven and the Oven Temp. Selector should not be set above 75°C.

WARNING: DO NOT PUT DELICATE CHINA OR ITEMS WHICH COULD BE AFFECTED BY HEAT INTO THE OVEN.

Fan Cooking

Turn the Oven Selector  to  and the Oven Temp selector  to the required temperature. The heat for Fan Cooking is provided by an element situated at the back of the oven and around the fan. Therefore with this cooking system it is possible to utilise the floor of the oven, either by standing baking tins directly on the floor of the oven or by placing an inverted shelf  on the floor. This allows for greater flexibility within the oven.

Baking

The advantage of this method of cooking is that as the oven heats up more quickly and generally foods cook at a lower temperature than in a conventional oven, pre-heating the oven is only required for certain types of food eg. Yorkshire pudding, bread, or if the cooking time is less than 25 minutes. Since the distribution of heat is more even most foods will cook satisfactorily in any shelf position, but the shelves should be evenly spaced. If only one shelf is being used then position 1 is preferable. Temperatures selected should be 10-30°C lower than with conventional heating – see separate recipe book.

When cooking a complete meal – for instance roast beef, roast potatoes, Yorkshire pudding and apple pie, place meat/potatoes on anti-splash tray in the meat pan and stand the pan on an inverted shelf  situated on the floor of the oven. Place the apple pie and Yorkshire pudding on a shelf at position 3.

When batch baking large quantities of food for home freezing or parties, use shelf positions 1, 3 and 4. Remember to place the food to be

cooked in the centre of each shelf to allow for even air circulation around the food. It may be necessary to increase the cooking times by a few minutes to allow for the larger mass of food, and to take out food on the upper shelf slightly earlier. If you are batch baking you will need to preheat the oven.

Detailed charts covering temperatures and shelf positions for Fan Cooking are given in the recipe book supplied.





Defrosting

Without heat – for frozen foods such as cakes, fruit, etc. the Oven Temp Selector should be set at 'O' (Off) and shelf position 2 used.

With heat – for chicken portions, sausages, meat rolls, etc. turn the Oven Temp Selector to 50-75°C and again use shelf position 2. This method of defrosting is only recommended for food up to 2 kg in weight and the food should be cooked immediately afterwards.

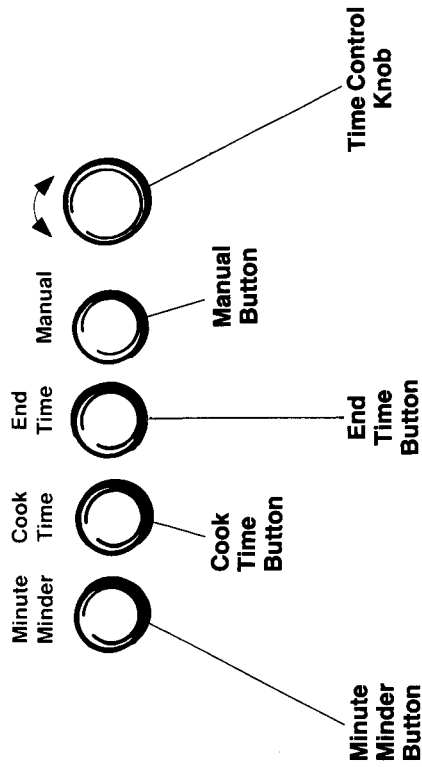
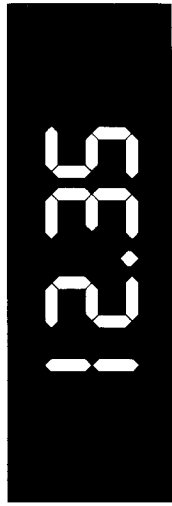
The Automatic Oven Timer



The Electronic Automatic Timer can be used to control the Oven, with the exception of the Grill. The timing operation is controlled by the Electronic Clock. Check that the clock is showing the correct time, if not reset it by pressing in both the Minute Minder and Cook Time Buttons and hold them in while turning the Time Control  until the correct time appears on the Clock. An arrow will flash above the Manual Button showing that the Oven is in the Automatic mode. To select Manual press the Manual Button and the arrow will disappear from above the button.



The Minute Minder

The Minute Minder can be used independently or in conjunction with the Automatic Timer and will give an audible reminder. It does not control the operation of the oven.

Press the Minute Minder Button and **00:00** will appear in the Display. Holding the button in turn the Time Control  to the length of time required. Release the button and the Clock will revert back to the time of day but with the arrow still showing above the Minute Minder Button. The Minute Minder Button can be pressed at any time to show how long it will be before it sounds. At the end of the set time the Minute Minder will sound for approximately 2 minutes but can be switched off beforehand by pressing any one of the buttons.



Conventional Cooking

Turn the Oven Selector  to the Conventional setting  and the Oven Temp Selector  to the required temperature. The heat for Conventional cooking is provided by the Grill element and the element under the floor of the oven. Therefore **DO NOT COOK DIRECTLY ON THE FLOOR OF THE OVEN**, or the food too close to the top element.

Baking

Always put the item you are baking in the centre of the shelf. You will find that shelf position 1 or 2 will give the best results. (See above illustration.) If you are baking on more than one shelf then the Fan Cooking System is recommended.

Detailed charts covering temperatures and shelf positions for Conventional Cooking are given in the recipe book supplied.

Roasting

If roasting in an open dish, shelf position 2 is recommended. If roasting directly in the meat pan use the anti-splash tray supplied so that, during cooking, all the fat drains into the base cavity, this ensures that oven cleaning is kept to a minimum. If roasting or casserole cooking in a closed dish, it should be placed on one of the wire shelves either at position 1 or 2 depending on the size of the dish.

The arrow above the Manual Button will start to flash.

- After use turn the appropriate controls to 'O' (Off) and press the Manual button to return the oven to Manual operation. (The arrow above the Manual Button will disappear.)

To set the Timer to switch OFF only

The Timer may be used to switch the oven OFF.

- Follow step 1 as above.
- Turn the Oven Selector to the type of heating required and the Oven Temp Selector to the correct temperature. The Oven thermostat light will come on and the oven will start to heat up.
- The oven will automatically switch OFF when the End Time is reached. At that time the arrow above the End Time Button will disappear and the Minute Minder will start to sound to remind you that the meal is ready to take out. The Minute Minder will sound for approximately 2 minutes but can be switched off beforehand by pressing any one of the buttons. The arrow above the Manual Button will start to flash.
- After use turn the appropriate controls to 'O' (Off) and press the Manual button to return the oven to Manual operation. (The arrow above the Manual Button will disappear.)



To set the Timer to switch ON and OFF automatically

- Press the End Time Button and an indicator arrow will appear above the button. Holding the End Time Button in, turn the Time Control  until the time you want the meal to finish cooking appears on the Clock. Release the button and the clock will revert back to the time of day with a second indicator arrow visible above the Manual Button to show the oven is in the Automatic Cooking Mode.
- Press the Cook Time Button, an indicator arrow will appear above the button. Holding the Cook Time Button in, turn the Time Control until the length of time you want the meal to cook for is shown on the Clock. (This sets the switching-on time.) Release the button and the clock will revert back to the time of day.
- Turn the Oven Selector to the type of heating required and the Oven Temp Selector to the correct temperature.
- The Oven will automatically switch ON (the middle indicator arrow will disappear) when the pre-selected start time has been reached and switch OFF when the End Time is reached. At that time the arrow above the Cook Time Button will disappear and the Minute Minder will start to sound to remind you that the meal is ready to take out. The Minute Minder will sound for approximately 2 minutes but can be switched off beforehand by pressing any one of the buttons.

Grilling

Full Width or Economy Settings

The grilling facility in the Top Oven enables you to use the full width of the grill or just the middle section depending on the amount of food you wish to grill at any one time.

To use the full width of the grill turn the Oven Temp Selector to  and for economy grilling turn it to . In both positions the grill power can be adjusted by means of the Dual Grill Control (settings 1-9). Grilling should be done with the Oven door CLOSED. There is no need to pre-heat. Use the grill pan with the anti-splash tray and the reversible grill pan grid if necessary in positions 4-6, according to the thickness of the food. If you find excessive smoke is being emitted then turn the Dual Grill Control to a lower setting and/or move the grill pan to a lower position. The grill pan must be cleaned after every use. Excess fat build up in the bottom of the pan could cause a fire hazard.

Fix the grill pan handle securely in position. With the grill pan handle in the vertical position, place the chrome section centrally over the grill pan lip. Drop the handle away from the grill pan and ensure that the handle is secure before use (see illustration).

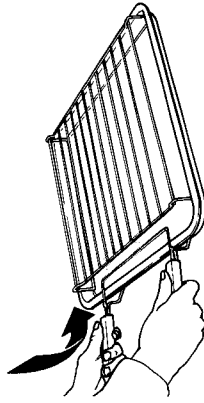

General notes on using the Automatic Timer

1. When setting any part of the Timer always keep the appropriate button pressed in with one hand and turn the Time Control at the same time with the other hand.
2. After a button has been released an arrow will remain above it on the Clock to act as a reminder of what has been selected.
3. If the arrow above the Manual Button flashes this means that the Oven is in the Automatic mode. Press the Manual Button to change the oven to Manual operation. (The arrow disappears.)
4. If you wish to cancel or change one of the settings simply press the appropriate button and turn the Time Control back to . Reset the appropriate button as required.
5. If after setting the Timer or when the meal has started to cook you

- want to know how long it will take simply press the Cook Time Button and the length of time will be shown on the Clock.
6. If you want to know when the cooking will come to an end simply press the End Time Button and the finishing time will be shown on the Clock.
 7. The Minute Minder can be set to come on before the end of automatic cooking eg. to remind you to put the vegetables on. The Minute Minder will sound a second time at the end of the automatic cooking period.
 8. Always remember to press the Manual Button after you have used the Automatic Timer to return the Oven to Manual operation.

WARNING: CHILDREN SHOULD NOT BE ALLOWED TO PLAY WITH THE CONTROLS OR TAMPER WITH THE APPLIANCE.

Before using your Oven for the first time

In some models the shelf racks will have to be inserted. To do this first push the long ends of the racks into the top openings in the side walls and then insert the bottom ends in the holes provided.

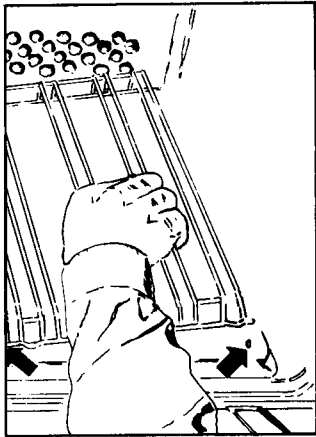

Make sure the electricity supply is switched ON.

Your Oven is fitted with an Electronic Clock and Timer. When switching the oven on for the first time or if the power supply has been interrupted the Electronic Clock Display will flash **00.00**. To set the clock to the time of day press both the Minute Minder and Cook Time Buttons and hold them in while turning the Time Control until the time of day appears in the Display. When you have reached the right time release the buttons and the clock will operate. Remember that the clock is a twenty-four hour one so that 3 o'clock in the afternoon will show on the Clock as **15.00**.

Manual/Automatic

For normal operation (without automatic timing) the Manual Button must be pressed so that the arrow above the button disappears – this ensures that the Oven is in the Manual mode.

To remove the 'new smell', heat up the empty oven for 30 minutes keeping the door closed. To heat up, the Oven turn the Oven Selector to  – the Control Panel will light up and the light inside the oven will come on – and set the Oven Temp Selector to 250. When you do this the Oven Thermostat light on the Control Panel will come on.

The new smell is due to any, temporary finish on oven fittings and elements and also any moisture absorbed by the lagging. The odour will cease after a short period of use. Ensure that the area is well ventilated and that persons and pets who are possibly sensitive to the odour are removed from the vicinity.

Position of shelves

To obtain the best results it is recommended that you use the meat pan provided either on its own if you are cooking on one shelf only or in conjunction with your own baking tins.

Only put in the shelves or fittings you usually want to use. Unused shelves only restrict access and get in the way. If possible it is a good idea to remove the fittings when you have finished cooking so that when you next come to use the oven you do not inadvertently heat up unnecessary shelves or tins – as well as being more convenient this will save electricity.

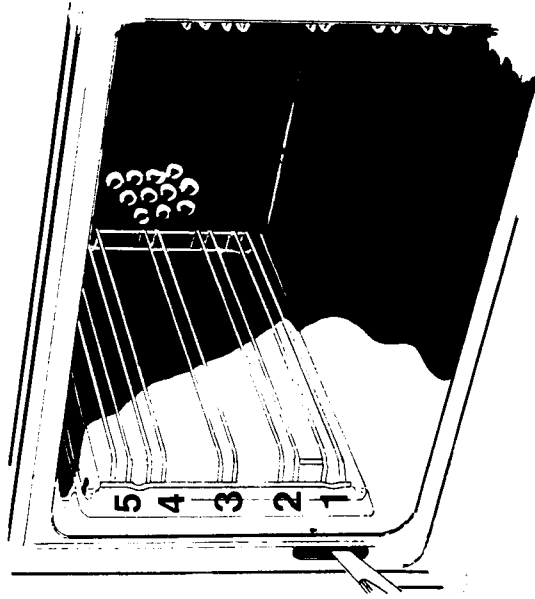

Note: If using aluminium foil **never** allow the foil to touch the sides and **never** cover the interior or shelves with foil.



Key Contacts

After Sales Service

Over 1100 trained specialists, directly employed by us, ensure that you have complete confidence in both the appliances and services we offer.

Repair Service

UK: 08709 066 066

(Open 8 to 8 Mon - Fri, 8 to 6 Sat & 10 to 4 Sun)

www.theservicecentre.co.uk

Republic of Ireland: 1850 302 200

Note: Our Service Operators will require the following information:

Model Number

Serial Number

Extended Warranties

UK: 08709 088 088

(Open 8 to 6 Mon - Fri)

www.theservicecentre.co.uk

Republic of Ireland: 1850 502 200

Genuine Parts and Accessories

UK: 08709 077 077

(Open 8-30 to 5-30 Mon - Fri, 8-30 to 12 Sat)

www.theservicecentre.co.uk

Republic of Ireland: (01) 842 6836

General Domestic Appliances Limited, Morley Way, Peterborough, PE2 9JB

Free Manuals Download Website

<http://myh66.com>

<http://usermanuals.us>

<http://www.somanuals.com>

<http://www.4manuals.cc>

<http://www.manual-lib.com>

<http://www.404manual.com>

<http://www.luxmanual.com>

<http://aubethermostatmanual.com>

Golf course search by state

<http://golfingnear.com>

Email search by domain

<http://emailbydomain.com>

Auto manuals search

<http://auto.somanuals.com>

TV manuals search

<http://tv.somanuals.com>